

Intermediate Macroeconomics

Julio Garín
Claremont McKenna College

Robert Lester
Colby College

Eric Sims
University of Notre Dame

August 2, 2018

This Version: 3.0.0

This is a book designed for use in an intermediate macroeconomics course or a masters level course in macroeconomics. It could also be used by graduate students seeking a refresher in advanced undergraduate macroeconomics. This book represents a substantial makeover and extension of the course notes for intermediate macroeconomics which have been provided publicly on Eric Sims’s personal [website](#) for several years.

There are many fine textbooks for macroeconomics at the intermediate level currently available. These texts include, but are certainly not limited to, [Mankiw \(2016\)](#), [Williamson \(2014\)](#), [Jones \(2013\)](#), [Barro \(1997\)](#), [Abel, Bernanke, and Croushore \(2017\)](#), [Gordon \(2012\)](#), [Hall and Pappell \(2005\)](#), [Blanchard \(2017\)](#), [Dornbusch, Fischer, and Startz \(2013\)](#), [Froyen \(2013\)](#), and [Chugh \(2015\)](#).

Given the large number of high quality texts already on the market, why the need for a new one? We view our book as fulfilling a couple of important and largely unmet needs in the existing market. First, our text makes much more use of mathematics than most intermediate books. Second, whereas most textbooks divide the study of the macroeconomy into two “runs” (the long run and the short run), we focus on three runs – the long run, the medium run, and the short run. Third, we have attempted to emphasize the microeconomic underpinnings of modern macroeconomics, all the while maintaining tractability and a focus on policy. Fourth, we include a section on banking, bank runs, bond pricing, and the stock market. While this material is generally left to money, credit, and banking texts, the recent Great Recession has taught us the importance of thinking seriously about the implications of the financial system for the macroeconomy. Finally, we feel that a defining feature of this text is that it is, if nothing else, thorough – we have tried hard to be very clear about mathematical derivations and to not skip steps when doing them.

Modern economics is increasingly quantitative and makes use of math. While it is important to emphasize that math is only a tool deployed to understand real-world phenomena, it is a highly useful tool. Math clearly communicates ideas which are often obfuscated when only words are used. Math also lends itself nicely to quantitative comparisons of models with real-world data. Our textbook freely makes use of mathematics, more so than most of the texts we cited above. An exception is [Chugh \(2015\)](#), who uses more math than we do. To successfully navigate this book, a student needs to be proficient at high school level algebra and be comfortable with a couple of basic rules of calculus and statistics. We have included Appendices [A](#) and [B](#) to help students navigate the mathematical concepts which are used throughout the book. While we find the approach of freely integrating mathematics into the analysis attractive, we recognize that it may not be well-suited for all students and all instructors. We have therefore written the book where the more involved mathematical analysis is contained in Part [III](#). This material can be skipped at the instructor’s discretion,

which allows an instructor to spend more time on the more graphical analysis used in Parts [IV](#) and [V](#).

Traditionally, macroeconomic analysis is divided into the “long run” (growth) and the “short run” (business cycles). We have added a third run to the mix, which we call the “medium run.” This is similar to the approach in [Blanchard \(2017\)](#), although we reverse ordering relative to Blanchard, studying the long run first, then the medium run, then the short run. Our principal framework for studying the long run in Part [II](#) is the canonical Solow model. We are attracted to this framework because it clearly elucidates the important role of productivity in accounting for both long run growth and cross-country income differences. A drawback is that the Solow model does not formally model microeconomic decision-making, as we do throughout the rest of the book. To that end, we have also included Chapter [8](#) using an overlapping generations framework with optimizing agents. This framework touches on many of the same issues as the Solow model, but allows us to address a number of other issues related to efficiency and the role of a government.

Whereas growth theory studies the role of capital accumulation and productivity growth over the span of decades, we think of the medium run as focusing on frequencies of time measured in periods of several years. Over this time horizon, investment is an important component of fluctuations in output, but it is appropriate to treat the stock of physical capital as approximately fixed. Further, nominal frictions which might distort the short run equilibrium relative to an efficient outcome are likely not relevant over this time horizon. Our framework for studying the medium run is what we call the neoclassical model (or real business cycle model). In this framework, output is supply determined and the equilibrium is efficient. The microeconomic underpinnings of the neoclassical model are laid out in Part [III](#) and a full graphical treatment is given in Part [IV](#).

We think of the short run as focusing on periods of time spanning months to several years. Our framework for studying the short run is a New Keynesian model with sticky prices. This analysis is carried out in Part [V](#). The only difference between our medium and short run models is the assumption of price rigidity, which makes the AS curve non-vertical – otherwise the models are the same. We consider two different versions of the sticky price model – one in which the price level is completely predetermined within period (the simple sticky price model) and another in which the price level is sensitive to the output gap (the partial sticky price model). With either form of price stickiness, demand shocks matter, and the scope for beneficial short run monetary and/or fiscal policies becomes apparent. Optimal monetary policy and complications raised by the zero lower bound (ZLB) are addressed. Appendix [D](#) develops a sticky wage model which has similar implications to the sticky price model.

Modern macroeconomics is simply microeconomics applied at a high level of aggregation.

To that end, we have devoted an entire part of the book, Part [III](#), to the “Microeconomics of Macroeconomics.” There we study an optimal consumption-saving problem, a firm profit maximization problem in a dynamic setting, equilibrium in an endowment economy, and discuss fiscal policy, money, and the First Welfare Theorem. Whereas for the most part we ignore unemployment throughout the book and instead simply focus on total labor input, we also include a chapter on search, matching, and unemployment. The analysis carried out in Part [III](#) serves as the underpinning for the remainder of the medium and short run analysis in the book, but we have tried to write the book where an instructor can omit Part [III](#) should he or she choose to do so.

Relatedly, modern macroeconomics takes dynamics seriously. We were initially attracted to the two period macroeconomic framework used in [Williamson \(2014\)](#), for which [Barro \(1997\)](#) served as a precursor. We have adopted this two period framework for Parts [III](#) through [V](#). That said, our experience suggested that the intertemporal supply relationship (due to an effect of the real interest rate on labor supply) that is the hallmark of the [Williamson \(2014\)](#) approach was ultimately confusing to students. It required spending too much time on a baseline market-clearing model of the business cycle and prevented moving more quickly to a framework where important policy implications could be addressed. We have simplified this by assuming that labor supply does not depend on the real interest rate. This can be motivated formally via use of preferences proposed in [Greenwood, Hercowitz, and Huffman \(1988\)](#), which feature no wealth effect on labor supply.

We were also attracted to the timeless IS-LM approach as laid out, for example, so eloquently by [Mankiw \(2016\)](#), [Abel, Bernanke, and Croushore \(2017\)](#), and others. Part [V](#) studies a short run New Keynesian model, freely making use of the commonly deployed IS-LM-AD-AS analysis. The medium run model we develop graphically in part [IV](#) can be cast in this framework with a vertical AS curve, which is often called the “long run supply curve” (or LRAS) in some texts. Because of our simplification concerning the dynamic nature of labor supply in Part [IV](#), we can move to the short run analysis in Part [V](#) quicker. Also, because the medium run equilibrium is efficient and the medium run can be understood as a special case of the short run, the policy implications in the short run become immediately clear. In particular, policy should be deployed in such a way that the short run equilibrium (where prices are sticky) coincides with the medium run equilibrium. Price stability is often a good normative goal, and monetary policy ought to target the natural or neutral rate of interest, which is the interest rate which would obtain in the absence of price or wage rigidities. This “Wicksellian” framework for thinking about policy is now the dominant paradigm for thinking about short run fluctuations in central banks. Within the context of the IS-LM-AD-AS model, we study the zero lower bound and an open economy version of

the model. [Jones \(2013\)](#) proposes replacing the LM curve with the monetary policy (MP) curve, which is based on a Taylor rule type framework for setting interest rates. We include an appendix, [Appendix E](#), where the MP curve replaces the LM curve.

Finally, the recent Great Recession has highlighted the importance of thinking about connections between the financial system and the macroeconomy. Part [VI](#) of the book is dedicated to studying banking, financial intermediation, and asset pricing in more depth. We include chapters on the basics of banking and bank runs, as well as a chapter that delves into the money supply process in more detail. We also have detailed chapters on bond and stock pricing in a dynamic, optimizing framework based on the stochastic discount factor. Much of this material is traditionally reserved for money, credit, and banking courses, but we think that recent events make the material all the more relevant for conventional macroeconomics courses. [Chapter 35](#) incorporates an exogenous credit spread variable into our medium/short run modeling framework and argues that exogenous increases in credit spreads are a sensible way to model financial frictions and crises. [Chapter 36](#) provides an in-depth accounting of the recent financial crisis and Great Recession and deploys the tools developed elsewhere in the book to understand the recession and the myriad policy interventions undertaken in its wake.

In writing this book, we have tried to follow the lead of [Glenmorangie](#), the distillery marketing itself as producing Scotch that is “unnecessarily well-made.” In particular, we have attempted throughout the book to be unnecessarily thorough. We present all the steps for various mathematical derivations and go out of our way to work through all the steps when deriving graphs and shifting curves. This all makes the book rather than longer than it might otherwise be. In a sense, it is our hope that a student could learn from this text without the aid of a formal instructor, though we think this is suboptimal. Our preference for this approach is rooted in our own experiences as students, where we found ourselves frustrated (and often confused) when instructors or textbooks skipped over too many details, instead preferring to focus on the “big picture.” There is no free lunch in economics, and our approach is not without cost. At present, the book is short on examples and real-world applications. We hope to augment the book along these dimensions in the coming months and years. The best real world examples are constantly changing, and this is an area where the instructor contributes some value added, helping to bring the text material to life.

The book is divided into six main parts. Part [I](#) serves as an introduction. [Chapter 1](#) reviews some basic definitions of aggregate macroeconomic variables. While most students should have seen this material in a principles course, we think it is important for them to see it again. [Chapter 2](#) defines what an economic model is and why a model is useful. This chapter motivates the rest of the analysis in the book, which is based on models. [Chapter 3](#) provides a brief overview of the history and controversies of macroeconomics.

We study the long run in Part II. We put the long run first, rather than last as in many textbooks, for two main reasons. First, growth is arguably much more important for welfare than is the business cycle. As Nobel Prize winner Robert Lucas once famously said, “Once you start to think about growth, it is difficult to think about anything else.” Second, the standard Solow model for thinking about growth is not based on intertemporal optimization, but rather assumes a constant saving rate. This framework does not fit well with the remainder of the book, which is built around intertemporal optimization. Nevertheless, the Solow model delivers many important insights about both the long run trends of an economy and the sizeable cross-country differences in economic outcomes. Chapter 4 lays out some basic facts about economic growth based on the contribution of Kaldor (1957). Chapter 5 studies the textbook Solow model. Chapter 6 considers an augmented version of the Solow model with exogenous productivity and population growth. Chapter 7 uses the Solow model to seek to understand cross-country differences in income. In the most recent edition of the book, we have also included a chapter using a dynamic, optimizing, overlapping generations framework (Chapter 8). While touching on similar issues to the Solow model, it allows to discuss things like market efficiency and potentially beneficial roles of a government. Though it ends up having similar implications as the Solow model, because the OLG economy features optimizing households in the context of a growth model, it provides a nice bridge to later parts of the book.

Part III is called the “Microeconomics of Macroeconomics” and studies optimal decision making in a two period, intertemporal framework. This is the most math-heavy component of the book, and later parts of the book, while referencing the material from this part, are meant to be self-contained. Chapter 9 studies optimal consumption-saving decisions in a two period framework, making use of indifference curves and budget lines. It also considers several extensions to the two period framework, including a study of the roles of wealth, uncertainty, and liquidity constraints in consumption-saving decisions. Chapter 10 extends this framework to more than two periods. Chapter 11 introduces the concept of competitive equilibrium in the context of the two period consumption-saving framework, emphasizing that the real interest rate is an intertemporal price which adjusts to clear markets in equilibrium. It also includes some discussion on heterogeneity and risk-sharing, which motivates the use of the representative agent framework used throughout the book. Chapter 12 introduces production, and studies optimal labor and investment demand for a firm and optimal labor supply for a household. Chapter 13 introduces fiscal policy into this framework. Here we discuss Ricardian Equivalence, which is used later in the book, but also note the conditions under which Ricardian Equivalence will fail to hold. Chapter 14 introduces money into the framework, motivating the demand for money through a money in the utility function

assumption. Here we do not go into detail on the money creation process, instead reserving that material for later in the book (Chapter 31). Chapter 15 discusses the equivalence of the dynamic production economy model laid out in Chapter 12 to the solution to a social planner's problem under certain conditions. In the process we discuss the First Welfare Theorem. Although we are mostly silent on unemployment, Chapter 16 includes a microeconomically founded discussion of unemployment using the Diamond-Mortensen-Pissarides framework.

The medium run is studied in Part IV. We refer to our model for understanding the medium run as the neoclassical model. It is based on the intertemporal frictionless production economy studied in more depth in Chapter 12, though the material is presented in such a way as to be self-contained. Most of the analysis is graphical in nature. The consumption, investment, money, and labor demand schedules used in this part come from the microeconomic decision-making problems studied in Part III, as does the labor supply schedule. Chapter 17 discusses these decision rules and presents a graphical depiction of the equilibrium, which is based on a traditional IS curve summarizing the demand side and a vertical curve which we will call the Y^s curve (after Williamson 2014) to describe the supply-side. The Y^s curve is vertical, rather than upward-sloping in a graph with the real interest rate on the vertical axis and output on the horizontal, because of our assumption of no wealth effects on labor supply. Appendix C carries out the analysis where the Y^s curve is instead upward-sloping, as in Williamson (2014). Chapter 18 graphically works through the effects of changes in exogenous variables on the endogenous variables of the model. Chapter 19 presents some basic facts about observed business cycle fluctuations and assesses the extent to which the neoclassical model can provide a reasonable account of those facts. In Chapter 20 we study the connection between the money supply, inflation, and nominal interest rates in the context of the neoclassical model. Chapter 21 discusses the policy implications of the model. The equilibrium is efficient, and so there is no scope for policy to attempt to combat fluctuations with monetary or fiscal interventions. In this chapter we also include an extensive discussion of criticisms which have been levied at the neoclassical / real business cycle paradigm for thinking about economic policy. Chapter 22 considers an open economy version of the neoclassical model, studying net exports and exchange rates.

Part V studies a New Keynesian model. This model is identical to the neoclassical model, with the exception that the aggregate price level is sticky. This stickiness allows demand shocks to matter and means that money is non-neutral. It also means that the short run equilibrium is in general inefficient, opening the door for desirable policy interventions. Chapter 23 develops the IS-LM-AD curves to describe the demand side of the model. What differentiates the New Keynesian model from the neoclassical model is not the demand side, but rather the supply side. Hence, the IS-LM-AD curves can also be used to describe the

demand side of the neoclassical model. We prefer our approach of first starting with the IS- Y^s curves because it better highlights monetary neutrality and the classical dichotomy. Chapter 24 develops a theory of a non-vertical aggregate supply curve based on price stickiness. An appendix develops a New Keynesian model based on wage stickiness rather than price stickiness, Appendix D. Chapter 25 works out the effects of changes in exogenous variables on the endogenous variables of the New Keynesian model and compares those effects to the neoclassical model. Chapter 26 develops a theory of the transition from short run to medium run. In particular, if the short run equilibrium differs from what would obtain in the neoclassical model, over time pressure on the price level results in shifts of the AS relationship that eventually restore the neoclassical equilibrium. On this basis we provide theoretical support for empirically observed Phillips Curve relationships. In Chapter 27 we study optimal monetary policy in the Keynesian model. The optimal policy is to adjust the money supply / interest rates so as to ensure that the equilibrium of the short run model coincides with the equilibrium which would obtain in the absence of price rigidity (i.e. the neoclassical, medium run equilibrium). Here, we talk about the Wicksellian “natural” or “neutral” rate of interest and its importance for policy. We also discuss the benefits of price stability. Chapter 28 studies the New Keynesian model when the zero lower bound is binding. Chapter 29 considers an open economy version of the New Keynesian model.

Recent events have highlighted the important connection between finance and macroeconomics. Part VI is dedicated to these issues. Chapter 30 discusses the basic business of banking and focuses on bank balance sheets. There we also discuss how banking has changed in the last several decades, discussing the rise of a so-called “shadow banking” sector. Chapter 31 studies the creation of money and defines terms like the monetary base and the money multiplier. Chapter 32 discusses the usefulness of the liquidity transformation in which financial intermediaries engage and the sensitivity of financial intermediaries to runs. To that end, we provide a simplified exposition of the classic [Diamond and Dybvig \(1983\)](#) model of bank runs. This material proves useful in thinking about the recent financial crisis. Chapters 33 and 34 study asset pricing in the context of a microeconomically founded consumption capital asset pricing model (CAPM) based on the stochastic discount factor. Chapter 33 studies the risk and term structures of interest rates and provides a framework for thinking seriously about both conventional and unconventional monetary policy. Chapter 34 studies the stock market and seeks to understand the equity premium. We also discuss the possibility of bubbles and whether policy ought to try to prevent them.

Although much research has been recently done, it is not straightforward to incorporate a non-trivial financial system in a compelling and tractable way into an otherwise standard macroeconomic framework. In Chapter 35, we argue that a convenient short cut is to include

an exogenous credit spread variable which we label f_t . This spread represents a premium firms must pay to finance investment over the return households receive on saving. It serves as a convenient stand-in for both the risk and term structures of interest rates. We argue that financial crises are best characterized as runs on liquidity which result in large increases in credit spreads. In terms of the IS-LM-AD-AS model, an increase in the exogenous credit spread variable shifts the IS and AD curves in to the left. In Chapter 36 we study financial crises more generally with a particular focus on the recent Great Recession. The presentation of this chapter ought to be at least somewhat self-contained, but it does make use of concepts studied in detail in Parts V and VI. We present facts, talk about the conventional wisdom concerning the origins of the crisis, map those origins into our New Keynesian framework, and then use that framework to think about the myriad unconventional policy measures which were deployed.

We realize that there is likely too much material presented here for a normal one semester course. It is our hope that our approach of presenting the material in as thorough as possible a manner will facilitate moving through the material quickly. As alluded to above, there are a number of different ways in which this book can be used. Part I could be skipped entirely, an instructor could have a teaching assistant work through it, or an instructor could require students to read the material on their own without devoting scarce class time to it. For studying growth, it may suffice to only focus on Chapter 5, skipping the augmented Solow model with exogenous productivity and population growth and/or the chapter on overlapping generations. Chapter 7 is written in such a way that the material in Chapter 6 need not have previously been covered.

Some instructors may see fit to skip all or parts of Part III. One option for condensing this material would be to skip Chapters 10 (which considers a multi-period extension of the two period consumption-saving model), 11 (which studies equilibrium in an endowment economy), or parts of Chapters 14 through 15. In Parts IV and V, one can condense the material by skipping the open economy chapters, Chapters 22 and 29. The book can be taught without any reference at all to the material in Part VI. Some instructors may find it suitable to substitute this material for other chapters. As this book is a work in progress, we too are experimenting with how to best structure a course based on this book, and would appreciate any feedback from instructors who have tried different course structures elsewhere.

Throughout the book, we include hyperlinked references to academic papers and other readings. These are denoted in blue and appear in the format “Name (year of publication).” For many publications, the references section includes hyperlinks to the papers in question. We also include hyperlinks to other external readings, in many cases [Wikipedia](#) entries on topics of interest. These are also indicated in blue, and in the online version can be

navigated to with a simple click. At the conclusion of each chapter, we include two sets of problems – one is called “Questions for Review” and requires mostly short written responses which simply review the material presented in the text, while the other is called “Exercises” and typically features longer problems requiring students to work through mathematical or graphical derivations, often times including extensions of the models presented in the text. Modern macroeconomics is quantitative, and quantitative skills are increasingly valued in many different types of jobs. To that end, we include several questions which require the students to work with data (either actual or artificial) using Microsoft Excel. These are demarcated with the indicator “[**Excel problem**]”.

We are grateful to several generations of undergraduate students at the University of Notre Dame, the University of Georgia, Claremont McKenna College, and Colby College who have taken intermediate macro courses using early versions of the course notes which eventually grew into this book. Their comments and feedback have improved the presentation and content of the resulting material. Ultimately, our students – past and future ones – are the reason we wrote this text. We are also grateful to Michael Pries for extensive comments on an earlier draft of this book.

We welcome any feedback on the textbook. As it is a work in progress, the manuscript is almost surely littered with typos and sections that may not be perfectly clear. If you have comments or suggestions along any of these lines, please email them to us at the addresses given below.

Julio Garín
Claremont McKenna College
jgarin@cmc.edu

Robert Lester
Colby College
rblester@colby.edu

Eric Sims
University of Notre Dame
esims1@nd.edu

Contents

I	Introduction	21
1	Macroeconomic Data	23
1.1	Calculating GDP	23
1.2	Real versus Nominal	28
1.3	The Consumer Price Index	34
1.4	Measuring the Labor Market	36
1.5	Summary	40
2	What is a Model?	45
2.1	Models and Why Economists Use Them	45
2.2	Summary	47
3	Brief History of Macroeconomic Thought	49
3.1	The Early Period: 1936-1968	49
3.2	Blowing Everything Up: 1968-1981	50
3.3	Modern Macroeconomics: 1982-2016	52
3.4	Summary	54
II	The Long Run	55
4	Facts About Economic Growth	58
4.1	Economic Growth over Time: The Kaldor Facts	58
4.2	Cross Country Facts	67
4.3	Summary	70
5	The Basic Solow Model	73
5.1	Production, Consumption, and Investment	73
5.2	Graphical Analysis of the Solow Model	82
5.3	The Algebra of the Steady State with Cobb-Douglas Production	89

5.4	Experiments: Changes in s and A	89
5.5	The Golden Rule	97
5.6	Summary	102
6	The Augmented Solow Model	108
6.1	Introducing Productivity and Population Growth	108
6.2	Graphical Analysis of the Augmented Model	113
6.3	The Steady State of the Augmented Model	114
6.4	Experiments: Changes in s and A	117
6.5	The Golden Rule	127
6.6	Will Economic Growth Continue Indefinitely?	129
6.7	Summary	130
7	Understanding Cross-Country Income Differences	133
7.1	Convergence	134
7.1.1	Conditional Convergence	138
7.2	Can Differences in s Account for Large Per Capita Output Differences?	140
7.3	The Role of Productivity	142
7.4	Summary	146
8	Overlapping Generations	150
8.1	The General Overlapping Generations Model	150
8.1.1	Households	151
8.1.2	Firm	153
8.1.3	Equilibrium and Aggregation	154
8.2	Cobb-Douglas Production and Logarithmic Utility	158
8.3	The Golden Rule and Dynamic Inefficiency	163
8.3.1	Government Intervention	166
8.4	Incorporating Exogenous Technological Growth	172
8.5	Summary	176
III	The Microeconomics of Macroeconomics	179
9	A Dynamic Consumption-Saving Model	181
9.1	Model Setup	182
9.2	Optimization and the Euler Equation	186
9.3	Indifference Curve / Budget Line Analysis and the Consumption Function	189

9.4	Extensions of the Two Period Consumption-Saving Model	202
9.4.1	Wealth	202
9.4.2	Permanent and Transitory Income Changes	206
9.4.3	Taxes	208
9.4.4	Uncertainty	210
9.4.5	Consumption and Predictable Changes in Income	215
9.4.6	Borrowing Constraints	217
9.5	Summary	223
10	A Multi-Period Consumption-Saving Model	229
10.1	Multi-Period Generalization	229
10.2	The MPC and Permanent vs. Transitory Changes in Income	236
10.3	The Life Cycle	239
10.4	Summary	243
11	Equilibrium in an Endowment Economy	248
11.1	Model Setup	248
11.2	Competitive Equilibrium	249
11.3	Identical Agents and Graphical Analysis of the Equilibrium	250
11.3.1	Supply Shock: Increase in Y_t	257
11.3.2	Demand Shock: Increase in Y_{t+1}	259
11.3.3	An Algebraic Example	261
11.4	Agents with Different Endowments	262
11.5	Summary	265
12	Production, Labor Demand, Investment, and Labor Supply	271
12.1	Firm	271
12.1.1	Diversion on Debt vs. Equity Finance	278
12.2	Household	280
12.3	Financial Intermediary	290
12.4	Equilibrium	290
12.5	Summary	292
13	Fiscal Policy	295
13.1	The Government	295
13.2	Fiscal Policy in an Endowment Economy	296
13.2.1	Graphical Effects of Changes in G_t and G_{t+1}	300

13.2.2 Algebraic Example	303
13.3 Fiscal Policy in a Production Economy	304
13.4 Summary	307
14 Money	313
14.1 What is Money?	313
14.2 Modeling Money in our Production Economy	316
14.2.1 Household	317
14.2.2 Firm	324
14.2.3 Government	325
14.2.4 Equilibrium	326
14.3 Summary	329
15 Equilibrium Efficiency	334
15.1 The Social Planner's Problem	335
15.1.1 The Basic Planner's Problem	336
15.1.2 Planner Gets to Choose M_t	339
15.1.3 Planner Gets to Choose G_t and G_{t+1}	341
15.2 Summary	343
16 Search, Matching, and Unemployment	347
16.1 Stylized Facts	348
16.2 The Bathtub Model of Unemployment	352
16.2.1 Transition Dynamics: A Quantitative Experiment	353
16.3 Two Sided Matching: The Diamond-Mortensen-Pissarides Model	356
16.3.1 The Matching Function	356
16.3.2 Household and Firm Behavior	358
16.3.3 Equilibrium	359
16.3.4 Example	362
16.3.5 Efficiency	363
16.4 Summary	365
IV The Medium Run	368
17 The Neoclassical Model	370
17.1 Household	370
17.2 Firm	373

17.3	Government	375
17.4	Equilibrium	376
17.5	Graphing the Equilibrium	377
17.5.1	The Demand Side	377
17.5.2	The Supply Side	381
17.5.3	Bringing it all Together	383
17.5.4	The Nominal Side	385
17.6	Summary	387
18	Effects of Shocks in the Neoclassical Model	390
18.1	Equilibrium	390
18.2	The Effects of Changes in Exogenous Variables on the Endogenous Variables	392
18.2.1	Productivity Shock: Increase in A_t :	393
18.2.2	Expected Future Productivity Shock: Increase in A_{t+1}	395
18.2.3	Government Spending Shock: Increase in G_t :	398
18.2.4	An Increase in the Money Supply: Increase in M_t	405
18.2.5	Expected Future Inflation: Increase in π_{t+1}^e	406
18.2.6	Summary of Qualitative Effects	407
18.3	Summary	407
19	Taking the Neoclassical Model to the Data	412
19.1	Measuring the Business Cycle	412
19.2	Can the Neoclassical Model Match Business Cycle Facts?	415
19.3	Is there Evidence that A_t Moves Around in the Data?	418
19.4	Summary	421
20	Money, Inflation, and Interest Rates	424
20.1	Measuring the Quantity of Money	424
20.1.1	How is the Money Supply Set?	426
20.2	Money, the Price Level, and Inflation	430
20.3	Inflation and Nominal Interest Rates	436
20.4	The Money Supply and Real Variables	438
20.5	Summary	441
21	Policy Implications and Criticisms of the Neoclassical Model	445
21.1	Criticisms	445
21.1.1	Measurement of TFP	446

21.1.2	What are these Productivity Shocks?	448
21.1.3	Other Quantitative Considerations	448
21.1.4	An Idealized Description of the Labor Market	448
21.1.5	Monetary Neutrality	449
21.1.6	The Role of Other Demand Shocks	449
21.1.7	Perfect Financial Markets	450
21.1.8	An Absence of Heterogeneity	451
21.2	A Defense of the Neoclassical Model	451
21.3	Summary	452
22	Open Economy Version of the Neoclassical Model	454
22.1	Exports, Imports, and Exchange Rates	454
22.2	Graphically Characterizing the Equilibrium	459
22.3	Effects of Shocks in the Open Economy Model	467
22.3.1	Positive IS Shock	467
22.3.2	Increase in A_t	471
22.3.3	Increase in Q_t	474
22.3.4	Increase in M_t	477
22.3.5	Increase in P_t^F	477
22.3.6	Summary of Qualitative Effects	477
22.4	Summary	478
V	The Short Run	481
23	The New Keynesian Demand Side: IS-LM-AD	485
23.1	The LM Curve	486
23.2	The IS Curve	489
23.3	The AD Curve	491
23.4	Summary	495
24	The New Keynesian Supply Side	498
24.1	The Neoclassical Model	498
24.2	New Keynesian Model	503
24.2.1	Simple Sticky Price Model	503
24.2.2	Partial Sticky Price Model	507
24.3	Summary	516

25 Effect of Shocks in the New Keynesian Model	518
25.1 The Neoclassical Model	518
25.2 Simple Sticky Price Model	525
25.3 Partial Sticky Price Model	535
25.4 Comparing the New Keynesian Model to the Neoclassical Model	547
25.5 Summary	549
26 Dynamics in the New Keynesian Model: Transition from Short Run to Medium Run	552
26.1 Simple Sticky Price Model	553
26.1.1 A Non-Optimal Short Run Equilibrium	553
26.1.2 Dynamic Responses to Shocks	556
26.2 Partial Sticky Price Model	564
26.2.1 A Non-Optimal Short Run Equilibrium	564
26.2.2 Dynamic Responses to Shocks	567
26.3 The Phillips Curve	576
26.3.1 Implications of the Phillips Curve for Monetary Policy	580
26.3.2 The Possibility of Costless Disinflation	583
26.4 Summary	587
27 Monetary Policy in the New Keynesian Model	591
27.1 Policy in the Partial Sticky Price Model	592
27.2 The Case for Price Stability	599
27.3 The Natural Rate of Interest and Monetary Policy	604
27.4 The Taylor Rule	609
28 The Zero Lower Bound	612
28.1 The IS-LM-AD Curves with the ZLB	614
28.2 Equilibrium Effects of Shocks with a Binding ZLB	620
28.3 Why is the ZLB Costly?	623
28.4 Fiscal Policy at the ZLB	628
28.5 How to Escape the ZLB	630
28.6 How to Avoid the ZLB	632
28.7 Summary	633
29 Open Economy Version of the New Keynesian Model	636
29.1 Deriving the AD Curve in the Open Economy	637

29.2	Equilibrium in the Open Economy Model	639
29.3	Comparing the Open and Closed Economy Variants of the Model	640
29.3.1	Comparison in the Small Open Economy Version of the Model	646
29.4	Effects of Foreign Shocks in the Open Economy New Keynesian Model	650
29.4.1	Increase in r_t^F	650
29.4.2	Increase in Q_t	652
29.5	Fixed Exchange Rates	654
29.6	Summary	661

VI Money, Credit, Banking, and Finance 663

30 The Basics of Banking 666

30.1	Asymmetric Information: Adverse Selection and Moral Hazard	668
30.2	The Bank Balance Sheet	673
30.3	Managing the Balance Sheet	676
30.3.1	Credit Risk	677
30.3.2	Liquidity Risk	679
30.4	Modern Banking and Shadow Banking	682
30.5	Summary	688

31 The Money Creation Process 690

31.1	Some Definitions and Algebra	690
31.2	Open Market Operations and the Simple Deposit Multiplier with T-Accounts	694
31.3	The Money Multiplier with Cash and Excess Reserve Holdings	701
31.4	Two Monetary Episodes: The Great Depression and Great Recession	714
31.4.1	Great Depression	715
31.4.2	Great Recession	718
31.4.3	Fractional Reserve Banking	722
31.5	Summary	723

32 A Model of Liquidity Transformation and Bank Runs 724

32.1	Model Assumptions	724
32.2	Enter a Bank	726
32.3	Bank Runs	729
32.4	Policies to Deal with Bank Runs	733
32.5	Summary	736

33 Bond Pricing and the Risk and Term Structures of Interest Rates	738
33.1 Bond Cash Flow Repayment Plans	739
33.1.1 Yield to Maturity	740
33.2 Bond Pricing with No Uncertainty: A General Equilibrium Approach	744
33.3 Default Risk and the Risk Structure of Interest Rates	749
33.3.1 No Income Risk	754
33.3.2 No Default Risk	757
33.3.3 Income Risk and Default Risk	759
33.4 Time to Maturity and the Term Structure of Interest Rates	762
33.4.1 No Uncertainty: The Expectations Hypothesis	765
33.4.2 Uncertainty and the Term Premium	770
33.5 Conventional versus Unconventional Monetary Policy	783
33.5.1 A Model with Short and Long Term Riskless Debt and Long Term Risky Debt	784
33.5.2 Conventional Monetary Policy	791
33.5.3 Unconventional Policy	793
33.6 Summary	801
34 The Stock Market and Bubbles	803
34.1 Equity Pricing in a Two Period General Equilibrium Model	805
34.2 Comparing Different Kinds of Stocks	812
34.3 Moving Beyond Two Periods	817
34.3.1 The Gordon Growth Model	827
34.4 Bubbles and the Role of the Terminal Condition	829
34.4.1 A Numerical Example with Bubbles	832
34.4.2 Should Monetary Policy Attempt to Prick Bubbles?	839
34.5 Equilibrium Stock Prices with Endogenous Production: the Neoclassical Model	841
34.6 Summary	845
35 Financial Factors in a Macro Model	848
35.1 Incorporating an Exogenous Credit Spread	849
35.2 Detailed Foundations	852
35.3 Equilibrium Effects of an Increase in the Credit Spread	855
35.4 The Financial Accelerator	857
35.5 Summary	865

36 Financial Crises and The Great Recession	867
36.1 Financial Crises: The Great Depression and Great Recession	867
36.2 The Great Recession: Some More Specifics on the Run	874
36.3 Thinking About the Great Recession in the AD-AS Model	881
36.4 Unconventional Policy Actions	888
36.4.1 Federal Reserve Lending	889
36.4.2 Fiscal Stimulus	892
36.4.3 Unconventional Monetary Policy	895
36.5 Lingering Questions	902
36.6 Summary	903
VII Appendices	927
A Mathematical Appendix	928
A.1 Variables and Parameters	928
A.2 Exponents and Logs	929
A.3 Summations and Discounted Summations	930
A.4 Growth Rates	932
A.5 Systems of Equations	934
A.6 Calculus	935
A.7 Optimization	941
B Probability and Statistics Appendix	951
B.1 Measures of Central Tendency: Mean, Median, Mode	951
B.2 Expected Value	952
B.3 Measures of Dispersion: Variance and Standard Deviation	956
B.4 Measures of Association: Covariance and Correlation	959
C The Neoclassical Model with an Upward-Sloping Y^s Curve	963
C.1 The Neoclassical Model with an Intertemporal Dimension to Labor Supply . .	964
C.2 Effects of Shocks with Upward-Sloping Y^s	968
C.3 Sources of Output Fluctuations with an Upward-Sloping Y^s Curve	972
D The New Keynesian Model with Sticky Wages	974
D.1 Equilibrium Effects of Shocks in the Sticky Wage Model	979
D.1.1 Comparing the Sticky Wage Model to the Neoclassical Model	989
D.2 Dynamics in the Sticky Wage Model	993

D.2.1	A Non-Optimal Short Run Equilibrium	993
D.2.2	Dynamic Responses to Shocks	995
E	Replacing the LM Curve with the MP Curve	1003
E.1	The AD Curve when the MP Curve Replaces the LM Curve	1003
E.2	The Modified Supply Side	1009
E.3	The IS-MP-AD-AS Model	1011
E.3.1	The Effects of Shocks in the IS-MP-AD-AS Model	1013

Part I

Introduction

Part I serves as an introduction to the book and a review of materials from a principles course. Chapter 1 reviews some basics concerning national income and product accounts (NIPA), discusses the distinction between real and nominal variables and how to construct an aggregate price index, and discusses different measures of labor market variables. Chapter 2 explains what an economic model is and why models are useful when thinking about the economy, particularly at a high level of aggregation. Chapter 3 includes a brief discussion of the history of macroeconomics. In so doing, it provides some context for how modern macroeconomics as it is now practiced came to be.

Chapter 1

Macroeconomic Data

In this chapter we define some basic macroeconomic variables and statistics and go over their construction as well as some of their properties. For those of you who took principles of macroeconomics, this should be a refresher. We start by describing what is perhaps the single most important economic indicator, GDP.

1.1 Calculating GDP

Gross domestic product (GDP) is the current dollar value of all final goods and services that are produced within a country within a given period of time. “Goods” are physical things that we consume (like a shirt) while “services” are things that we consume but which are not necessarily tangible (like education). “Final” means that intermediate goods are excluded from the calculation. For example, rubber is used to produce tires, which are used to produce new cars. We do not count the rubber or the tires in used to construct a new car in GDP, as these are not final goods – people do not use the tires independently of the new car. The value of the tires is subsumed in the value of the newly produced car – counting both the value of the tires and the value of the car would “double count” the tires, so we only look at “final” goods.¹ “Current” means that the goods are valued at their current period market prices (more on this below in the discussion of the distinction between “real” and “nominal”).

GDP is frequently used as a measure of the standard of living in an economy. There are many obvious problems with using GDP as a measure of well-being – as defined, it does not take into account movements in prices versus quantities (see below); the true value to society of some goods or services may differ from their market prices; GDP does not measure non-market activities, like meals cooked at home as opposed to meals served in a restaurant (or things that are illegal); it does not say anything about the distribution of resources among society; etc. Nevertheless, other measures of well-being have issues as well, so we will focus

¹There are many nuances in the NIPA accounts, and this example is no exception. Tires included in the production of a new car are not counted in GDP because these are not final goods, but replacement tires sold at an auto shop for an already owned car are. More generally, depending on circumstances sometimes a good is an intermediate good and other times it is a final good.

on GDP.

Let there be n total final goods and services in the economy – for example, cell phones (a good), haircuts (a service), etc. Denote the quantities of each good (indexed by i) produced in year t by $y_{i,t}$ for $i = 1, 2, \dots, n$ and prices by $p_{i,t}$. GDP in year t is the sum of prices times quantities:

$$\text{GDP}_t = p_{1,t}y_{1,t} + p_{2,t}y_{2,t} + \dots + p_{n,t}y_{n,t} = \sum_{i=1}^n p_{i,t}y_{i,t}$$

As defined, GDP is a measure of total production in a given period (say a year). It must also be equal to total income in a given period. The intuition for this is that the sale price of a good must be distributed as income to the different factors of production that went into producing that good – i.e. wages to labor, profits to entrepreneurship, interest to capital (capital is some factor of production, or input, that itself has to be produced and is not used up in the production process), etc. For example, suppose that an entrepreneur has a company that uses workers and chain-saws to produce firewood. Suppose that the company produces 1000 logs at \$1 per log; pays its workers \$10 per hour and the workers work 50 hours; and pays \$100 to the bank, from which it got a loan to purchase the chain-saw. Total payments to labor are \$500, interest is \$100, and the entrepreneur keeps the remaining \$400 as profit. The logs contribute \$1000 to GDP, \$500 to wages, \$100 to interest payments, and \$400 to profits, with $\$500 + \$100 + \$400 = \$1,000$.

The so-called “expenditure” approach to GDP measures GDP as the sum of consumption, C ; investment, I ; government expenditure, G ; and net exports, NX . Net exports is equal to exports, X , minus imports, IM , where exports are defined as goods and services produced domestically and sold abroad and imports are defined as goods and services produced abroad and purchased domestically. Formally:

$$\text{GDP}_t = C_t + I_t + G_t + (X_t - IM_t) \tag{1.1}$$

Loosely speaking, there are four broad actors in an aggregate economy: households, firms, government (federal, state, and local), and the rest of the world. We measure aggregate expenditure by adding up the spending on final goods and services by each of these actors. Things that households purchase – food, gas, cars, etc. – count as consumption. Firms produce stuff. Their expenditures on new capital, which is what is used to produce new goods (e.g. a bulldozer to help build roads), is what we call investment. Government expenditures includes everything the government spends either on buying goods (like courthouses, machine guns, etc.) or on services (including, in particular, the services provided by government employees). The latter half – basically counting government payments to workers as expenditure – is making use of the fact that income = expenditure from above, as there is no other feasible

way to “value” some government activities (like providing defense). This number does not include transfer payments (social security, Medicaid, etc.) and interest payments on debt from the government (which together amount to a lot). The reason transfer payments do not count in government expenditure is that these transfers do not, in and of themselves, constitute expenditure on new goods and services. However, when a retiree takes her Social Security payment and purchases groceries, or when a Medicaid recipient visits a doctor, those expenditures get counted in GDP. Finally, we add in net exports (more on this in a minute). In summary, what this identity says is that the value of everything produced, GDP_t , must be equal to the sum of the expenditure by the different actors in the economy. In other words, the total value of production must equal the total value of expenditure. So we shall use the words production, income, and expenditure interchangeably.

If we want to sum up expenditure to get the total value of production, why do we subtract imports (IM in the notation above)? After all, GDP is a measure of production in a country in a given period of time, while imports measure production from other countries. The reason is because our notion of GDP is the value of goods and services produced *within* a country; the expenditure categories of consumption, investment, and government spending do not distinguish between goods and services that are produced domestically or abroad. So, for example, suppose you purchase an imported Mercedes for \$50,000. This causes C to go up, but should not affect GDP. Since this was produced somewhere else, IM goes up by exactly \$50,000, leaving GDP unaffected. Similarly, you could imagine a firm purchasing a Canadian made bulldozer – I and IM would both go up in equal amounts, leaving GDP unaffected. You could also imagine the government purchasing foreign-produced warplanes which would move G and IM in offsetting and equal directions. As for exports, a Boeing plane produced in Seattle but sold to Qatar would not show up in consumption, investment, or government spending, but it will appear in net exports, as it should since it is a component of domestic production.

There are a couple of other caveats that one needs to mention, both of which involve how investment is calculated. In addition to business purchases of new capital (again, capital is stuff used to produce stuff), investment also includes new residential construction and inventory accumulation. New residential construction is new houses. Even though households are purchasing the houses, we count this as investment. Why? At a fundamental level investment is expenditure on stuff that helps you produce output in the future. A house is just like that – you purchase a house today (a “stock”), and it provides a “flow” of benefits for many years going forward into the future. There are many other goods that have a similar feature – we call these “durable” goods – things like cars, televisions, appliances, etc. At some level we ought to classify these as investment too, but for the purposes of national income

accounting, they count as consumption. From an economic perspective they are really more like investment; it is the distinction between “firm” and “household” that leads us to put new durable goods expenditures into consumption. However, even though residential homes are purchased by households, new home construction is counted as a component of investment.

Inventory “investment” is the second slightly odd category. Inventory investment is the accumulation (or dis-accumulation) of unsold, newly produced goods. For example, suppose that a company produced a car in 1999 but did not sell it in that year. It needs to count in 1999 GDP since it was produced in 1999, but cannot count in 1999 consumption because it has not been bought yet. Hence, we count it as investment in 1999, or more specifically inventory investment. When the car is sold (say in 2000), consumption goes up, but GDP should not go up. Here inventory investment would go down in exactly the same amount of the increase in consumption, leaving GDP unaffected.

We now turn to looking at the data, over time, of GDP and its expenditure components. Figure 1.1 plots the natural log of GDP across time. These data are quarterly and begin in 1947.² The data are also seasonally adjusted – unless otherwise noted, we want to look at seasonally adjusted data when making comparisons across time. The reason for this is that there are predictable, seasonal components to expenditure that would make comparisons between quarters difficult (and would introduce some systematic “choppiness” into the plots – download the data and see for yourself). For example, there are predictable spikes in consumer spending around the holidays, or increases in residential investment in the warm summer months.

When looking at aggregate series it is common to plot series in the natural log. This is nice because, as you can see in Appendix A, it means that we can interpret differences in the log across time as (approximately) percentage differences – reading off the vertical difference between two points in time is approximately the percentage difference of the variable over that period. For example, the natural log of real GDP increases from about 6.0 in 1955 to about 6.5 in 1965; this difference of 0.5 in the natural logs means that GDP increased by approximately 50 percent over this period. For reasons we will discuss more in detail below, plotting GDP without making a “correction” for inflation makes the series look smoother than the “real” series actually is. To the eye, one observes that GDP appeared to grow at a faster rate in the 1970s than it did later in the 1980s and 1990s. This is at least partially driven by higher inflation in the 1970s (again, more on this below).

²You can download the data for yourselves from the [Bureau of Economic Analysis](#).

Figure 1.1: Logarithm of Nominal GDP

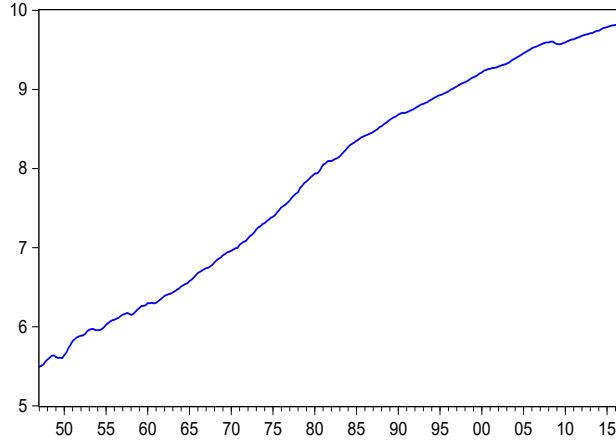
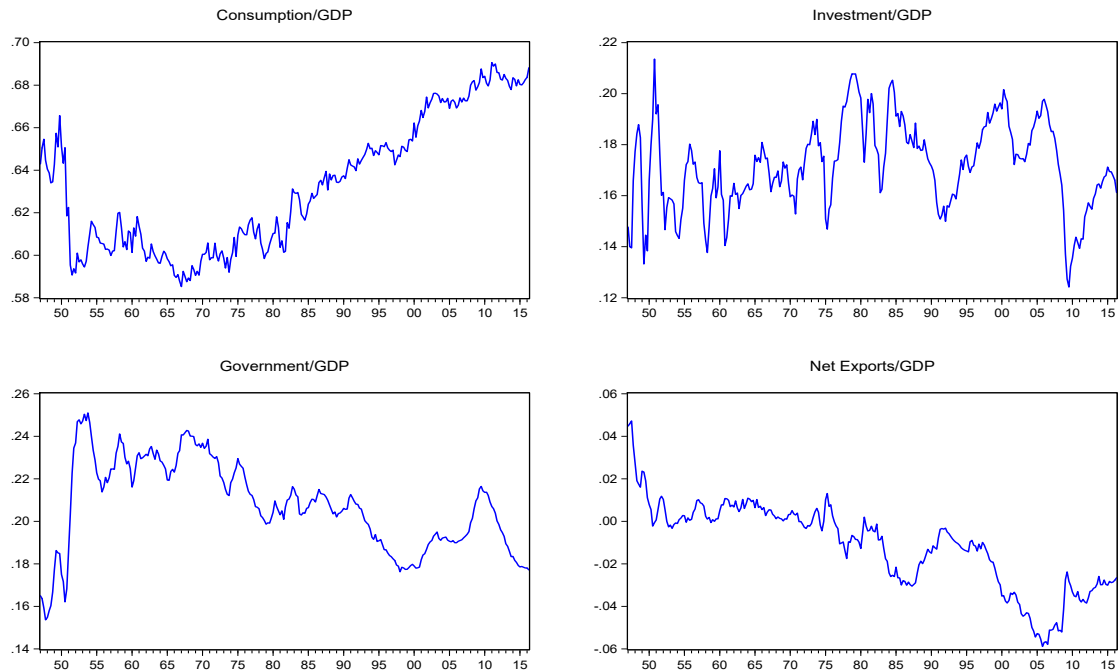

Figure 1.2 plots the components of GDP, expressed as shares of total GDP. We see that consumption expenditures account for somewhere between 60-70 percent of total GDP, making consumption by far the biggest component of aggregate spending. This series has trended up a little bit over time; this upward trend is largely mirrored by a downward trend in net exports. At the beginning of the post-war sample we exported more than we imported, so that net exports were positive (but nevertheless still a small fraction of overall GDP). As we've moved forward into the future net exports have trended down, so that we now import more than we export. Investment is about 15 percent of total GDP. Even though this is a small component, visually you can see that it appears quite volatile relative to the other components. This is an important point to which we shall return later. Finally, government spending has been fairly stable at around 20 percent of total GDP. The large increase very early in the sample has to do with the Korean War and the start of the Cold War.

Figure 1.2: GDP Components as a Share of Total GDP



1.2 Real versus Nominal

Measured GDP could change either because prices or quantities change. Because we are interested in the behavior of quantities (which is ultimately what matters for well-being), we would like a measure of production (equivalent to income and expenditure) that removes the influence of price changes over time. This is what we call real GDP.

Subject to the caveat of GDP calculation below, in principle real prices are denominated in units of goods, whereas nominal prices are denominated in units of money. Money is anything which serves as a unit of account. As we'll see later in the book, money solves a bartering problem and hence makes exchange much more efficient.

To make things clear, let's take a very simple example. Suppose you only have one good, call it y . People trade this good using money, call it M . We are going to set money to be the *numeraire*: it serves as the “unit of account,” i.e. the units by which value is measured. Let p be the price of goods relative to money – p tells you how many units of M you need to buy one unit of y . So, if $p = 1.50$, it says that it takes 1.50 units of money (say dollars) to buy a good. Suppose an economy produces 10 units of y , e.g. $y = 10$, and the price of goods in terms of money is $p = 1.50$. This means that nominal output is 15 units of money (e.g. 1.50×10 , or $p \cdot y$). It is nominal because it is denominated in units of M – it says how many units of M the quantity of y is worth. The real value is of course just y – that is the quantity

of goods, denominated in units of goods. To get the real from the nominal we just divide by the price level:

$$\begin{aligned}\text{Real} &= \frac{\text{Nominal}}{\text{Price}} \\ &= \frac{py}{p} \\ &= y.\end{aligned}$$

Ultimately, we are concerned with real variables, not nominal variables. What we get utility from is how many apples we eat, not whether we denominate one apple as one dollar, 100 Uruguayan pesos, or 1.5 euros.

Going from nominal to real becomes a little more difficult when we go to a multi-good world. You can immediately see why – if there are multiple goods, and real variables are denominated in units of goods, which good should we use as the numeraire? Suppose you have two goods, y_1 and y_2 . Suppose that the price measured in units of money of the first good is p_1 and the price of good 2 is p_2 . The nominal quantity of goods is:

$$\text{Nominal} = p_1y_1 + p_2y_2.$$

Now, the real relative price between y_1 and y_2 is just the ratio of nominal prices, p_1/p_2 . p_1 is “dollars per unit of good 1” and p_2 is “dollars per unit of good 2”, so the ratio of the prices is “units of good 2 per units of good 1.” Formally:

$$\frac{p_1}{p_2} = \frac{\frac{\$}{\text{good 1}}}{\frac{\$}{\text{good 2}}} = \frac{\text{good 2}}{\text{good 1}} \quad (1.2)$$

In other words, the price ratio tells you how many units of good 2 you can get with one unit of good 1. For example, suppose the price of apples is \$5 and the price of oranges is \$1. The relative price is 5 – you can get five oranges by giving up one apple. You can, of course, define the relative price the other way as $1/5$ – you can buy $1/5$ of an apple with one orange.

We could define real output (or GDP) in one of two ways: in units of good 1 or units of good 2:

$$\begin{aligned}\text{Real}_1 &= y_1 + \frac{p_2}{p_1}y_2 \quad (\text{Units are good 1}) \\ \text{Real}_2 &= \frac{p_1}{p_2}y_1 + y_2 \quad (\text{Units are good 2}).\end{aligned}$$

As you can imagine, this might become a little unwieldy, particularly if there are many goods. It would be like walking around saying that real GDP is 14 units of Diet Coke, or 6

cheeseburgers, if Diet Coke or cheeseburgers were used as the numeraire. As such, we have adopted the convention that we use money as the numeraire and report GDP in nominal terms as dollars of output (or euros or lira or whatever).

But that raises the issue of how to track changes in GDP across time. In the example above, what if both p_1 and p_2 doubled between two periods, but y_1 and y_2 stayed the same? Then nominal GDP would double as well, but we'd still have the same quantity of stuff. Hence, we want a measure of GDP that can account for this, but which is still measured in dollars (as opposed to units of one particular good). What we typically call “real” GDP in the National Income and Products Accounts is what would more accurately be called “constant dollar GDP.” Basically, one arbitrarily picks a year as a baseline. Then in subsequent years one multiplies quantities by base year prices. If year t is the base year, then what we call real GDP in year $t + s$ is equal to the sum of quantities of stuff produced in year $t + s$ weighted by the prices from year t . This differs from nominal GDP in that base year prices are used instead of current year prices. Let Y_{t+s} denote real GDP in year $t + s$, $s = 0, 1, 2, \dots$. Let there be n distinct goods produced. For quantities of goods $y_{1,t+s}, y_{2,t+s}, \dots, y_{n,t+s}$, we have:

$$\begin{aligned} Y_t &= p_{1,t}y_{1,t} + p_{2,t}y_{2,t} + \dots + p_{n,t}y_{n,t} \\ Y_{t+1} &= p_{1,t}y_{1,t+1} + p_{2,t}y_{2,t+1} + \dots + p_{n,t}y_{n,t+1} \\ Y_{t+2} &= p_{1,t}y_{1,t+2} + p_{2,t}y_{2,t+2} + \dots + p_{n,t}y_{n,t+2}. \end{aligned}$$

Or, more generally, using the summation notation covered in Appendix A:

$$Y_{t+h} = \sum_{i=1}^n p_{i,t}y_{i,t+h} \quad \text{for } h = 0, 1, 2.$$

From this we can implicitly define a price index (an implicit price index) as the ratio of nominal to real GDP in a given year:

$$\begin{aligned} P_t &= \frac{p_{1,t}y_{1,t} + p_{2,t}y_{2,t} + \dots + p_{n,t}y_{n,t}}{p_{1,t}y_{1,t} + p_{2,t}y_{2,t} + \dots + p_{n,t}y_{n,t}} = 1 \\ P_{t+1} &= \frac{p_{1,t+1}y_{1,t+1} + p_{2,t+1}y_{2,t+1} + \dots + p_{n,t+1}y_{n,t+1}}{p_{1,t}y_{1,t+1} + p_{2,t}y_{2,t+1} + \dots + p_{n,t}y_{n,t+1}} \\ P_{t+2} &= \frac{p_{1,t+2}y_{1,t+2} + p_{2,t+2}y_{2,t+2} + \dots + p_{n,t+2}y_{n,t+2}}{p_{1,t}y_{1,t+2} + p_{2,t}y_{2,t+2} + \dots + p_{n,t}y_{n,t+2}}. \end{aligned}$$

Or, more succinctly,

$$P_{t+h} = \frac{\sum_{i=1}^n p_{i,t+h}y_{i,t+h}}{\sum_{i=1}^n p_{i,t}y_{i,t+h}} \quad \text{for } h = 0, 1, 2.$$

A couple of things are evident here. First, we have normalized real and nominal GDP to be the same in the base year (which we are taking as year t). This also means that we are normalizing the price level to be one in the base year (what you usually see presented in national accounts is the price level multiplied by 100). Second, there is an identity here that nominal GDP divided by the price level equals real GDP. If prices on average are rising, then nominal GDP will go up faster than real GDP, so that the price level will rise.

A problem with this approach is that the choice of the base year is arbitrary. This matters to the extent that the relative prices of goods vary over time. To see why this might be a problem, let us consider a simple example. Suppose that an economy produces two goods: haircuts and computers. In year t , let the price of haircuts be \$5 and computers by \$500, and there be 100 hair cuts and 10 computers produced. In year $t + 1$, suppose the price of haircuts is \$10, but the price of computers is now \$300. Suppose that there are still 100 haircuts produced but now 20 computers. Nominal GDP in year t is \$5,500, and in year $t + 1$ it is \$7,000. If one uses year t as the base year, then real GDP equals nominal in year t , and real GDP in $t + 1$ is \$10,500. Using year t as the base year, one would conclude that real GDP grew by about 91 percent from t to $t + 1$. What happens if we instead use year $t + 1$ as the base year? Then real GDP in year $t + 1$ would be \$7,000, and in year t real GDP would be \$4,000. One would conclude that real GDP grew between t and $t + 1$ by 75 percent, which is substantially different than the 91 percent one obtains when using t as the base year.

To deal with this issue, statisticians have come up with a solution that they call chain-weighting. Essentially they calculate real GDP in any two consecutive years (say, 1989 and 1990) two different ways: once using 1989 as the base year, once using 1990 as the base year. Then they calculate the growth rate of real GDP between the two years using both base years and take the geometric average of the two growth rates. Chain-weighting is a technical detail that we need not concern ourselves with much, but it does matter in practice, as relative prices of goods have changed a lot over time. For example, computers are far cheaper in relative terms now than they were 10 or 20 years ago.

Throughout the book we will be mainly dealing with models in which there is only one good – we’ll often refer to it as fruit, but it could be anything. Fruit is a particularly convenient example for reasons which will become evident later in the book. This is obviously an abstraction, but it’s a useful one. With just one good, real GDP is just the amount of that good produced. Hence, as a practical matter we won’t be returning to these issues of how to measure real GDP in a multi-good world.

Figure 1.3 below plots the log of real GDP across time in the left panel. Though considerably less smooth than the plot of log nominal GDP in Figure 1.1, the feature that sticks out most from this figure is the trend growth – you can approximate log real GDP

pretty well across time with a straight line, which, since we are looking at the natural log, means roughly constant trend growth across time. We refer to this straight line as a “trend.” This is meant to capture the long term behavior of the series. The average growth rate (log first difference) of quarterly nominal GDP from 1947-2016 was 0.016, or 1.6 percent. This translates into an annualized rate (what is most often reported) of about 6 percent (approximately 1.6×4). The average growth rate of real GDP, in contrast, is significantly lower at about 0.008, or 0.8 percent per quarter, translating into about 3.2 percent at an annualized rate. From the identities above, we know that nominal GDP is equal to the price level times real GDP. As the growth rate of a product is approximately equal to the sum of the growth rates, growth in nominal GDP should approximately equal growth in prices (inflation) plus growth in real GDP.

Figure 1.3: Real GDP

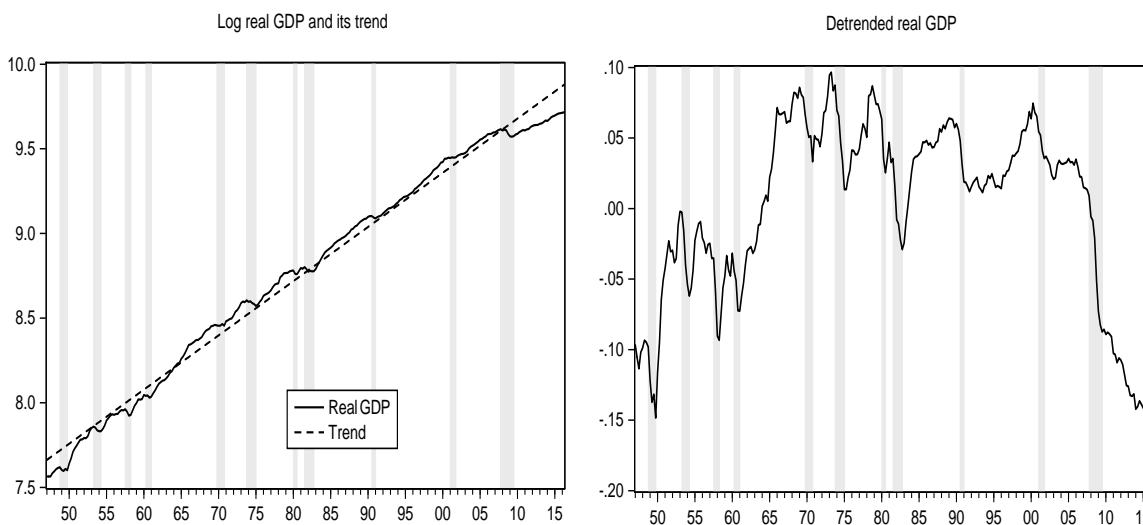
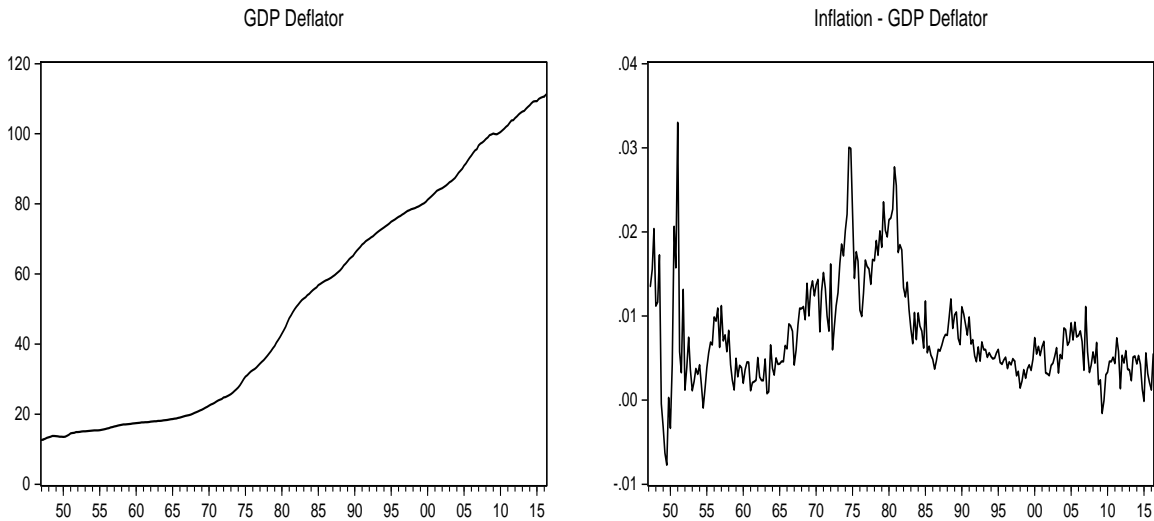

Figure 1.4 plots the log GDP deflator and inflation (the growth rate or log first difference of the GDP deflator) in the right panel. On average inflation has been about 0.008, or 0.8 percent per quarter, which itself translates to about 3 percent per year. Note that $0.008 + 0.008 = 0.016$, so the identity appears to work. Put differently, about half of the growth in nominal GDP is coming from prices, and half is coming from increases in real output. It is worth pointing out that there has been substantial heterogeneity across time in the behavior of inflation – inflation was quite high and volatile in the 1970s but has been fairly low and stable since then.

Figure 1.4: GDP Deflator



Turning our focus back to the real GDP graph, note that the blips are very minor in comparison to the trend growth. The right panel plots “detrended” real GDP, which is defined as actual log real GDP minus its trend. In other words, detrended GDP is what is left over after we subtract the trend from the actual real GDP series. The vertical gray shaded areas are “recessions” as defined by the [National Bureau of Economic Research](#). There is no formal definition of a recession, but loosely speaking they define a recession as two or more quarters of a sustained slowdown in overall economic activity. For most of the recession periods, in the left plot we can see GDP declining if we look hard enough. But even in the most recent recession (official dates 2007Q4–2009Q2), the decline is fairly small in relation to the impressive trend growth. You can see the “blips” much more clearly in the right plot. During most of the observed recessions, real GDP falls by about 5 percentage points (i.e. 0.05 log points) relative to trend. The most recent recession really stands out in this respect, where we see GDP falling by more than 10 percent relative to trend.

A final thing to mention before moving on is that at least part of the increase in real GDP over time is due to population growth. With more people working, it is natural that we will produce more products and services. The question from a welfare perspective is whether there are more goods and services *per person*. For this reason, it is also quite common to look at “per capita” measures, which are series divided by the total population. Population growth has been pretty smooth over time. Since the end of WW2 it has averaged about 0.003 per quarter, or 0.3 percent, which translates to about 1.2 percent per year. Because population growth is so smooth, plotting real GDP per capita will produce a similar looking figure to that shown in Figure 1.3, but it won’t grow as fast. Across time, the average growth rate of real GDP per capita has been 0.0045, 0.45 percent, or close to 2 percent per year.

Doing a quick decomposition, we can approximate the growth rate of nominal GDP as the sum of the growth rates of prices, population, and real GDP per capita. This works out to $0.008 + 0.003 + 0.0045 = 0.0155 \approx 0.016$ per quarter, so again the approximation works out well. At an annualized rate, we've had population growth of about 1.2 percent per year, price growth of about 3.2 percent per year, and real GDP per capita growth of about 2 percent per year. Hence, if you look at the amount of stuff we produce per person, this has grown by about 2 percent per year since 1947.

1.3 The Consumer Price Index

The consumer price index (CPI) is another popular macro variable that gets mentioned a lot in the news. When news commentators talk about “inflation” they are usually referencing the CPI.

The CPI is trying to measure the same thing as the GDP deflator (the average level of prices), but does so in a conceptually different way. The building block of the CPI is a “consumption basket of goods.” The Bureau of Labor Statistics (BLS) studies buying habits and comes up with a “basket” of goods that the average household consumes each month. The basket includes both different kinds of goods and different quantities. The basket may include 12 gallons of milk, 40 gallons of gasoline, 4 pounds of coffee, etc.

Suppose that there are N total goods in the basket, and let x_i denote the amount of good i ($i = 1, \dots, N$) that the average household consumes. The total price of the basket in any year t is just the sum of the prices in that year times the quantities. Note that the quantities are held fixed and hence do not get time subscripts – the idea is to have the basket not change over time:

$$\text{Cost}_t = p_{1,t}x_1 + p_{2,t}x_2 + \dots + p_{N,t}x_N.$$

The CPI in year t , call it P_t^{cpi} , is the ratio of the cost of the basket in that year relative to the cost of the basket in some arbitrary base year, b :

$$\begin{aligned} P_t^{cpi} &= \frac{\text{Cost}_t}{\text{Cost}_b} \\ &= \frac{p_{1,t}x_1 + p_{2,t}x_2 + \dots + p_{N,t}x_N}{p_{1,b}x_1 + p_{2,b}x_2 + \dots + p_{N,b}x_N} \\ &= \frac{\sum_{i=1}^N p_{i,t}x_i}{\sum_{i=1}^N p_{i,b}x_i}. \end{aligned}$$

As in the case of the GDP deflator, the choice of the base year is arbitrary, and the price level will be normalized to 1 in that year (in practice they multiply the number by 100 when

presenting the number). The key thing here is that the basket – both the goods in the basket and the quantities – are held fixed across time (of course in practice the basket is periodically redefined). The idea is to see how the total cost of consuming a fixed set of goods changes over time. If prices are rising on average, the CPI will be greater than 1 in years after the base year and less than 1 prior to the base year (as with the implicit price deflator it is common to see the CPI multiplied by 100).

Figure 1.5 plots the natural log of the CPI across time. It broadly looks similar to the GDP deflator – trending up over time, with an acceleration in the trend in the 1970s and something of a flattening in the early 1980s. There are some differences, though. For example, at the end of 2008 inflation as measured by the CPI went quite negative, whereas it only dropped to about zero for the GDP deflator. On average, the CPI gives a higher measure of inflation relative to the deflator and it is more volatile. For the entire sample, the average inflation by the GDP deflator is 0.8 percent per quarter (about 3.2 percent annualized); for the CPI it is 0.9 percent per quarter (about 3.6 percent annualized). The standard deviation (a measure of volatility) of deflator inflation is 0.6 percent, while it is 0.8 percent for the CPI.

Figure 1.5: CPI

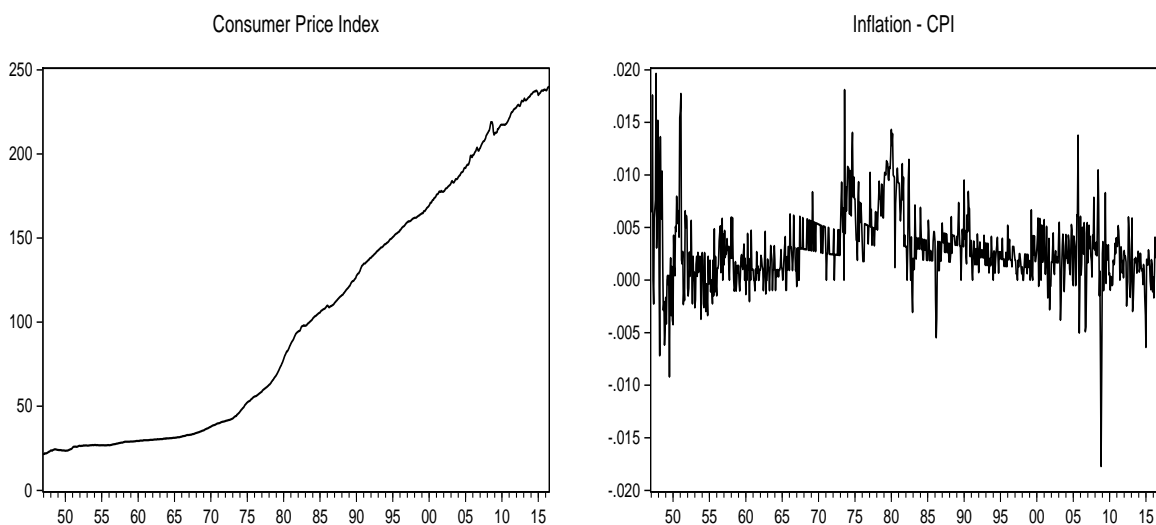

The reason for these differences gets to the basics of how the two indices are constructed and what they are intended to measure. A simple way to remember the main difference is that the CPI fixes base year quantities and uses updated prices, whereas the deflator is based on the construction of constant dollar GDP, which fixes base year prices and uses updated quantities. The fixing of quantities is one of the principal reasons why the CPI gives a higher measure of inflation. From principles of microeconomics we know that when relative prices change, people will tend to substitute away from relatively more expensive goods and into relatively cheaper goods – the so-called substitution effect. By fixing quantities, the CPI

does not allow for this substitution away from relatively expensive goods. To the extent that relative prices vary across time, the CPI will tend to overstate changes in the price of the basket. It is this substitution bias that accounts for much of the difference between inflation as measured by the CPI and the deflator. There are other obvious differences – the CPI does not include all goods produced in a country, and the CPI can include goods produced in other countries. Because the deflator is based on what the country actually produces, whereas the CPI is based on what the country consumes (which are different constructs due to investment, exports, and imports), it follows that if a country produces much more of a particular product than it consumes, then this product will have a bigger impact on the implicit price deflator than on the CPI. For getting a sense of overall price inflation in US produced goods, the GDP deflator is thus preferred. For getting a sense of nominal changes in the cost of living for the average household, the CPI is a good measure.

Chain weighting can also be applied to the CPI. As described above in the context of the GDP deflator, chain-weighting attempts to limit the influence of the base year. This is an attempt to deal with substitution biases in a sense because relative price changes will result in the basket of goods that the typical household consumes changing. Whether to chain-weight or not, and what kind of price index to use to index government transfer payments like Social Security, is a potentially important political issue. If inflation is really 2 percent per year, but the price index used to update Social Security payments measures inflation (incorrectly) at 3 percent per year, then Social Security payments will grow in real terms by 1 percent. While this may not seem like much in any one year, over time this can make a big difference for the real burden of Social Security transfers for a government.

1.4 Measuring the Labor Market

One of the key areas on which the press is focused is the labor market. This usually takes the form of talking about the unemployment rate, but there are other ways to measure the “strength” or “health” of the aggregate labor market. The unemployment rate is nevertheless a fairly good indicator of the overall strength of the economy – it tends to be elevated in “bad” times and low in “good” times.

An economy’s total labor input is a key determinant of how much GDP it can produce. What is relevant for how much an economy produces is the size of the total labor input. There are two dimensions along which we can measure labor input – the extensive margin (bodies) and the intensive margin (amount of time spent working per person). Define L as the total population, E as the number of people working (note that $E \leq L$), and h as the average number of hours each working person works (we’ll measure the unit of time as an

hour, but could do this differently, of course). Total hours worked, N , in an economy are then given by:

$$N = h \times E.$$

Total hours worked is the most comprehensive measure of labor input in an economy. Because of differences and time trends in population, we typically divide this by L to express this as total hours worked per capita (implicitly per unit of time, i.e. a year or a quarter). This measure represents movements in two margins – average hours per worker and number of workers per population. Denote hours per capita as $n = N/L$:

$$n = \frac{h \times E}{L}.$$

As you may have noticed, the most popular metric of the labor market in the press is the unemployment rate. To define the unemployment rate we need to introduce some new concepts. Define the labor force, LF , as everyone who is either (i) working or (ii) actively seeking work. Define U as the number of people who are in the second category – looking for work but not currently working. Then:

$$LF = E + U.$$

Note that $LF \leq L$. We define the labor force participation rate, lfp , as the labor force divided by the total working age population:

$$lfp = \frac{LF}{L}.$$

Define the unemployment rate as the ratio of people who are unemployed divided by the labor force:

$$\begin{aligned} u &= \frac{U}{LF} \\ &= \frac{U}{U + E}. \end{aligned}$$

Figure 1.6 plot these different measures of the labor market: (i) the unemployment rate; (ii) the employment to population ratio, $\frac{E}{L}$; (iii) the natural log of average hours worked per person; (iv) the labor force participation rate; and (iv) log hours worked per capita, n .³ To get an idea for how these series vary with output movements, we included NBER “recession

³Note that there is no natural interpretation of the units of the graphs of average hours per worker and total hours per capita. The underlying series are available in index form (i.e. unitless, normalized to be 100 in some base year) and are then transformed via the natural log.

dates” as indicated by the shaded gray bars.

Figure 1.6: Labor Market Variables

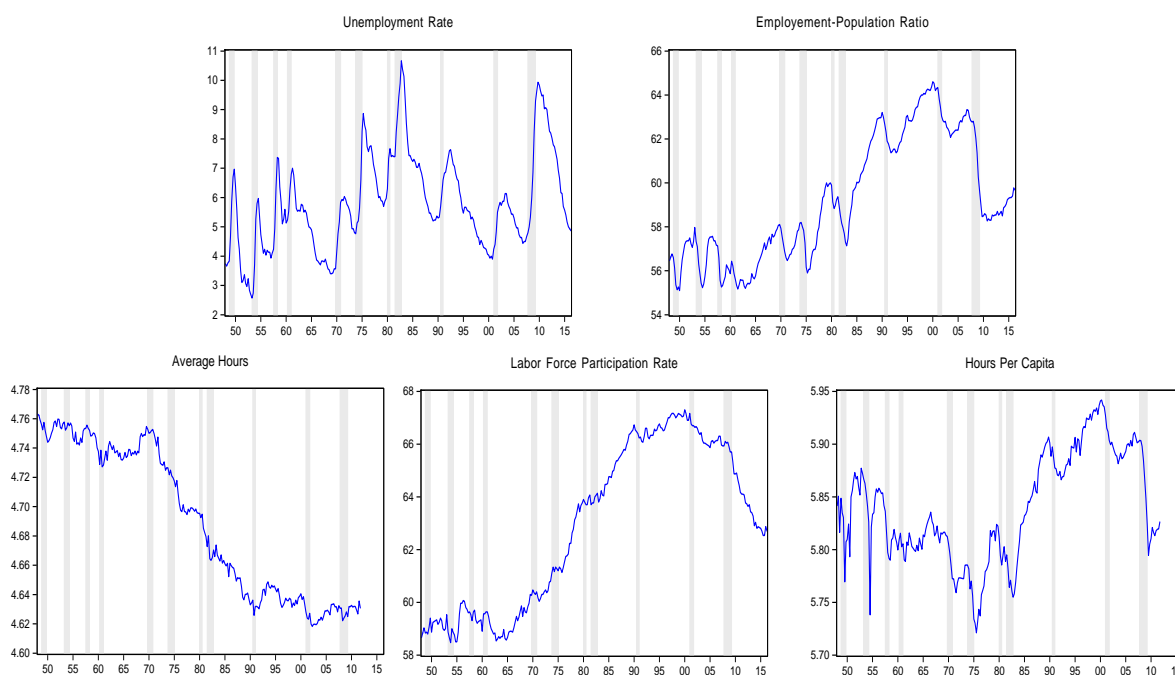

A couple of observations are in order. First, hours worked per capita fluctuates around a roughly constant mean – in other words, there is no obvious trend up or down. This would indicate that individuals are working about as much today as they did fifty years ago. But the measure of hours worked per capita masks two trends evident in its components. The labor force participation rate (and the employment-population ratio) have both trended up since 1950. This is largely driven by women entering the labor force. In contrast, average hours per worker has declined over time – this means that, conditional on working, most people work a shorter work week now than 50 years ago (the units in the figure are log points of an index, but the average workweek itself has gone from something like 40 hours per week to 36). So the lack of a trend in total hours worked occurs because the extra bodies in the labor force have made up for the fact that those working are working less on average.

In terms of movements over the business cycle, these series display some of the properties you might expect. Hours worked per capita tends to decline during a recession. For example, from the end of 2007 (when the most recent recession began) to the end of 2009, hours worked per capita fell by about 10 percent. The unemployment rate tends to increase during recessions – in the most recent one, it increased by about 5-6 percentage points, from around 5 percent to a maximum of 10 percent. Average hours worked tends to also decline during recessions, but this movement is small and does not stand out relative to the trend. The

employment to population ratio falls during recessions, much more markedly than average hours. In the last several recessions, the labor force participation rate tends to fall (which is sometimes called the “discouraged worker” phenomenon, to which we will return below), with this effect being particularly pronounced (and highly persistent) around the most recent recession.

In spite of its popularity, the unemployment rate is a highly imperfect measure of labor input. The unemployment rate can move because (i) the number of unemployed changes or (ii) the number of employed changes, where (i) does not necessarily imply (ii). For example, the number of unemployed could fall if some who were officially unemployed quit looking for work, and are therefore counted as leaving the labor force, without any change in employment and hours. We typically call such workers “discouraged workers” – this outcome is not considered a “good” thing, but it leads to the unemployment rate falling. Another problem is that the unemployment rate does not say anything about intensity of work or part time work. For example, if all of the employed persons in an economy are switched to part time, there would be no change in the unemployment rate, but most people would not view this change as a “good thing” either. In either of these hypothetical scenarios, hours worked per capita is probably a better measure of what is going on in the aggregate labor market. In the case of a worker becoming “discouraged,” the unemployment rate dropping would be illusory, whereas hours worked per capita would be unchanged. In the case of a movement from full time to part time, the unemployment rate would not move, but hours per capita would reflect the downward movement in labor input. For these reasons the unemployment rate is a difficult statistic to interpret. As a measure of total labor input, hours per capita is a preferred measure. For these reasons, many economists often focus on hours worked per capita as a measure of the strength of the labor market.

For most of the chapters in this book, we are going to abstract from unemployment, instead focusing on how total labor input is determined in equilibrium (without really differentiating between the intensive and extensive margins). It is not trivial to think about the existence of unemployment in frictionless markets – there must be some friction which prevents individuals looking for work from meeting up with firms who are looking for workers. However, later, in [Chapter 16](#) we study a model that can be used to understand why an economy can simultaneously have firms looking for workers and unemployed workers looking for firms. Frictions in this setting can result in potential matches not occurring, resulting in unemployment.

1.5 Summary

- Gross Domestic Product (GDP) equals the dollar value of all goods and services produced in an economy over a specific unit of time. The revenue from production must be distributed to employees, investors, payments to banks, profits, or to the government (as taxes). Every dollar a business or person spends on a produced good or service is divided into consumption, investment, or government spending.
- GDP is an identity in that the dollar value of production must equal the dollar value of all expenditure which in turn must equal the dollar value of all income. For this identity to hold, net exports must be added to expenditure since the other expenditure categories do not discriminate over where a consumed good was produced.
- GDP may change over time because prices change or output changes. Changes in output are what we care about for welfare. To address this, real GDP uses constant prices over time to measure changes in output.
- Changes in prices indexes and deflators are a way to measure inflation and deflation. A problem with commonly used price indexes like the consumer price index is that they overstate inflation on average.
- The most comprehensive measure of the labor input is total hours. Total hours can change because the number of workers are changing or because the average hours per worker changes. Other commonly used metrics of the labor market include hours per capita, the unemployment rate, and the labor force participation rate.

Key Terms

- Nominal GDP
- Real GDP
- GDP price deflator
- Numeraire
- Chain weighting
- Consumer Price Index
- Substitution bias
- Unemployment rate
- Labor force participation rate

Questions for Review

1. Explain why the three methods of calculating GDP are always equal to each other.
2. Why are intermediate goods subtracted when calculating GDP under the production method?
3. Why are imports subtracted when calculating GDP under the expenditure method?
4. Discuss the expenditure shares of GDP over time. Which ones have gotten bigger and which ones have gotten smaller?
5. Explain the difference between real and nominal GDP.
6. Discuss the differences between the CPI and the GDP deflator.
7. Discuss some problems with using the unemployment rate as a barometer for the health of the labor market.
8. Hours worked per worker has declined over the last 50 years yet hours per capita have remained roughly constant. How is this possible?

Exercises

1. An economy produces three goods: houses, guns, and apples. The price of each is \$1. For the purposes of this problem, assume that all exchange involving houses involves newly constructed houses.
 - (a) Households buy 10 houses and 90 apples, eating them. The government buys 10 guns. There is no other economic activity. What are the values of the different components of GDP (consumption, investment, government spending, exports/imports)?
 - (b) The next year, households buy 10 houses and 90 apples. The government buys 10 guns. Farmers take the seeds from 10 more apples and plant them. Households then sell 10 apples to France for \$1 each and buy 10 bananas from Canada for \$2 each, eating them too. What are the values of the components of GDP?
 - (c) Return to the economy in part [1a](#). The government notices that the two richest households consume 40 apples each, while the ten poorest consume one each. It levies a tax of 30 apples on each of the rich households, and gives 6 apples each to the 10 poorest households. All

other purchases by households and the government are the same as in (a). Calculate the components of GDP.

2. Suppose the unemployment rate is 6%, the total working-age population is 120 million, and the number of unemployed is 3.5 million. Determine:
 - (a) The participation rate.
 - (b) The size of the labor force.
 - (c) The number of employed workers.
 - (d) The Employment-Population rate.
3. Suppose an economy produces steel, wheat, and oil. The steel industry produces \$100,000 in revenue, spends \$4,000 on oil, \$10,000 on wheat, pays workers \$80,000. The wheat industry produces \$150,000 in revenue, spends \$20,000 on oil, \$10,000 on steel, and pays workers \$90,000. The oil industry produces \$200,000 in revenue, spends \$40,000 on wheat, \$30,000 on steel, and pays workers \$100,000. There is no government. There are neither exports nor imports, and none of the industries accumulate or deaccumulate inventories. Calculate GDP using the production and income methods.
4. This question demonstrates why the CPI may be a misleading measure of inflation. Go back to Micro Theory. A consumer chooses two goods x and y to minimize expenditure subject to achieving some target level of utility, \bar{u} . Formally, the consumer's problem is

$$\min_{x,y} E = p_x x + p_y y$$

$$\text{s.t. } \bar{u} = x^\alpha y^\beta$$

Total expenditure equals the price of good x times the number of units of x purchased plus the price of good y times the number of units of y purchased. α and β are parameters between 0 and 1. p_x and p_y are the dollar prices of the two goods. All the math required for this problem is contained in Appendix A.

- (a) Using the constraint, solve for x as a function of y and \bar{u} . Substitute your solution into the objective function. Now you are choosing only one variable, y , to minimize expenditure.
- (b) Take the first order necessary condition for y .
- (c) Show that the second order condition is satisfied. Note, this is a one

variable problem.

- (d) Use your answer from part b to solve for the optimal quantity of y , y^* . y^* should be a function of the parameters α and β and the exogenous variables, p_x, p_y and \bar{u} . Next, use this answer for y^* and your answer from part a to solve for the optimal level of x , x^* . Note, the solutions of endogenous variables, x^* and y^* in this case, only depend on parameters and exogenous variables, not endogenous variables.
- (e) Assume $\alpha = \beta = 0.5$ and $\bar{u} = 5$. In the year 2000, $p_x = p_y = \$10$. Calculate x_{2000}^*, y_{2000}^* and total expenditure, E_{2000} . We will use these quantities as our “consumption basket” and the year 2000 as our base year.
- (f) In 2001, suppose p_y increases to \$20. Using the consumption basket from part e, calculate the cost of the consumption basket in 2001. What is the inflation rate?
- (g) Now use your results from part d to calculate the 2001 optimal quantities x_{2001}^* and y_{2001}^* and total expenditures, E_{2001} . Calculate the percent change between expenditures in 2000 and 2001.
- (h) Why is the percent change in expenditures less than the percent change in the CPI? Use this to explain why the CPI may be a misleading measure of the cost of living.
5. **[Excel Problem]** Download quarterly, seasonal adjusted data on US real GDP, personal consumption expenditures, and gross private domestic investment for the period 1960Q1-2016Q2. You can find these data in the [BEA NIPA Table 1.1.6](#), “Real Gross Domestic Product, Chained Dollars”.
- (a) Take the natural logarithm of each series (“=ln(series)”) and plot each against time. Which series appears to move around the most? Which series appears to move the least?
- (b) The growth rate of a random variable x , between dates $t - 1$ and t is defined as

$$g_t^x = \frac{x_t - x_{t-1}}{x_{t-1}}.$$

Calculate the growth rate of each of the three series (using the raw series, not the logged series) and write down the average growth rate of each series over the entire sample period. Are the average growth rates of each series approximately the same?

- (c) In Appendix A we show that that the first difference of the log is

approximately equal to the growth rate:

$$g_t^x \approx \ln x_t - \ln x_{t-1}.$$

Compute the approximate growth rate of each series this way. Comment on the quality of the approximation.

- (d) The standard deviation of a series of random variables is a measure of how much the variable jumps around about its mean (“=stdev(series)”). Take the time series standard deviations of the growth rates of the three series mentioned above and rank them in terms of magnitude.
- (e) The [National Bureau of Economic Research \(NBER\)](#) declares business cycle peaks and troughs (i.e. recessions and expansions) through a subjective assessment of overall economic conditions. A popular definition of a recession (not the one used by the NBER) is a period of time in which real GDP declines for at least two consecutive quarters. Use this consecutive quarter decline definition to come up with your own recession dates for the entire post-war period. Compare the dates to those given by the NBER.
- (f) The most recent recession is dated by the NBER to have begun in the fourth quarter of 2007, and officially ended after the second quarter of 2009, though the recovery in the last three years has been weak. Compute the average growth rate of real GDP for the period 2003Q1–2007Q3. Compute a counterfactual time path of the level of real GDP if it had grown at that rate over the period 2007Q4–2010Q2. Visually compare that counterfactual time path of GDP, and comment (intelligently) on the cost of the recent recession.

Chapter 2

What is a Model?

Jorge Luis Borges “On Exactitude in Science”:

In that Empire, the Art of Cartography attained such perfection that the map of a single province occupied the entirety of a city, and the map of the Empire, the entirety of a province. In time, those unconscionable maps no longer satisfied, and the cartographers guilds struck a map of the Empire whose size was that of the Empire, and which coincided point for point with it. The following generations, who were not so fond of the study of cartography as their forebears had been, saw that that vast map was useless, and not without some pitilessness was it, that they delivered it up to the inclemencies of sun and winters. In the Deserts of the West, still today, there are tattered ruins of that map, inhabited by animals and beggars; in all the land there is no other relic of the disciplines of geography.

Suárez Miranda

Viajes de varones prudentes, Libro IV, Cap. XLV, Lérida, 1658

2.1 Models and Why Economists Use Them

To an economist, a model is a simplified representation of the economy; it is essentially a representation of the economy in which only the main ingredients are being accounted for. Since we are interested in analyzing the direction of relationships (e.g. does investment go up or down when interest rates increase?) and the quantitative impact of those (e.g. how much does investment change after a one percentage point increase in interest rates?), in economics, a model is composed of a set of mathematical relationships. Through these mathematical relationships, the economist determines how variables (like an interest rate) affect each other (e.g. investment). Models are not the only way to study human behavior. Indeed, in the natural sciences, scientists typically follow a different approach.

Imagine a chemist wants to examine the effectiveness of a certain new medicine in addressing a specific illness. After testing the effects of drugs on guinea pigs the chemist decides to perform experiments on humans. How would she go about it? Well, she will select a group of people willing to participate – providing the right incentives as, we know from

principles, incentives can affect behavior – and, among these, she randomly divides members in two groups: a control and a treatment group. The control group will be given a placebo (something that resembles the medicine to be given but has no physical effect in the person who takes it). The treatment group is composed by the individuals that were selected to take the real medicine. As you may suspect, the effects of the medicine on humans will be based on the differences between the treatment and control group. As these individuals were randomly selected, any difference to which the illness is affecting them can be attributed to the medicine. In other words, the experiment provides a way of measuring the extent to which that particular drug is effective in diminishing the effects of the disease.

Ideally, we would like to perform the same type of experiments with respect to economic policies. Variations of lab experiments have proven to be a useful approach in some areas of economics that focus on very specific markets or group of agents. In macroeconomics, however, things are different.

Suppose we are interested in studying the effects of training programs in improving the chances unemployed workers find jobs. Clearly the best way to do this would be to split the pool of unemployed workers in two groups, whose members are randomly selected. Here is where the problem with experiments of this sort becomes clear. Given the cost associated with unemployment, would it be morally acceptable to prevent some workers from joining a program that could potentially reduce the time without a job? What if we are trying to understand the effects a sudden reduction in income has on consumption for groups with different levels of savings? Would it be morally acceptable to suddenly confiscate income from a group? Most would agree not. As such, economists develop models, and in these models we run experiments. A model provides us a fictitious economy in which these issues can be analyzed and the economic mechanisms can be understood.

All models are not created equal and some models are better to answer one particular question but not another one. Given this, you may wonder how to judge when a model is appropriate. This is a difficult question. The soft consensus, however, is that a model should be able to capture features of the data that it was not artificially constructed to capture. Any simplified representation of reality will not have the ability to explain every aspect of that reality. In the same way, a simplified version of the economy will not be able to account for all the data that an economy generates. A model that can be useful to study how unemployed workers and firms find each other will not necessarily be able to account for the behavior of important economic variables such as the interest rate. What is expected is that the model matches relevant features of the process through which workers and firms meet.

While this exercise is useful to understand and highlights relevant economic mechanisms, it is not sufficient for providing policy prescriptions. For the latter, we would expect the

model to be able to generate predictions that are consistent with empirical facts for which the model was not designed to account. That gives us confidence that the framework is a good one, in the sense of describing the economy. Returning to our example, if the model designed to study the encounter of workers and firms is also able to describe the behavior of, for instance, wages, it will give us confidence that we have the mechanism that is generating these predictions in the model. The more a model explains, the more confidence economists have in using that model to predict the effects of various policies.

In addition to providing us with a “laboratory” in which experiments can be performed, models allow us to disentangle specific relationships by focusing on the most fundamental components of an economy. Reality is extremely complex. People not only can own a house or a car but they can also own a pet. Is it important to account for the latter when studying the effects of monetary policy? If the answer is no, then the model can abstract from that.

Deciding what “main ingredients” should be included in the model depends on the question at hand. For many questions, assuming individuals do not have children is a fine assumption, as long as that is not relevant to answering the question at hand. If we are trying to understand how saving rates in China are affected by the one-child policy, however, then we would need to depart from the simplifying assumption of no children and incorporate a richer family structure into our framework. In other words, what parts of the reality should be simplified would depend on the question at hand. While some assumptions may seem odd, the reality is that abstraction is part of every model in any scientific discipline. Meteorologists, physicists, biologists, and engineers, among others, rely on these parsimonious representations of the real world to analyze their problems.

New York is significantly larger than the screen of your smartphone. However, for the purpose of navigating Manhattan or finding your way to Buffalo, it is essential that the map does not provide the level of detail you see while driving or walking around. As the initial paragraph in this section suggests, a map the size of the place that is being represented is useless. By the same token, a model that accounts for all or most aspects of reality would be incomprehensible. Criticizing a model purely for its simplicity, while easy to do, misunderstands why we use models in the first place. Always remember the words of George Box: “All models are wrong, but some are useful.”

2.2 Summary

- A model is a simplified representation of a complex reality.
- We use models to conduct experiments which we cannot run in the real world and use the results from these experiments to inform policy-making

- If a model is designed to explain phenomenon x , a test for the usefulness of a model is whether it can explain phenomenon y which the model was not designed to explain. However, a model not being able to explain all features of reality is not a knock against the model.
- All models are wrong, but some are useful.

Questions for Review

1. Suppose that you want to write down a model to explain the observed relationship between interest rates and aggregate economic spending. Suppose that you want to test other predictions of your model. You consider two such predictions. First, your model predicts that there is no relationship between interest rates and temperature, but in the data there is a mild negative relationship. Second, your model predicts that consumption and income are negatively correlated, whereas they are positively correlated in the data. Which of these failures is problematic for your model and which is not? Why?
2. During recessions, central banks tend to cut interest rates. You are interested in understanding the question of how interest rates affect GDP. You look in the data and see that interest rates tend to be low when GDP is low (i.e. the interest rate is procyclical). Why do you think this simple correlation might give a misleading sense of the effect of changes in the interest rate on GDP? How might a model help you answer this question?
3. Suppose that you are interested in answering the question of how consumption reacts to tax cuts. In recent years, recessions have been countered with tax rebates, wherein households are sent a check for several hundred dollars. This check amounts to a “rebate” of past taxes paid. If you could design an ideal experiment to answer this question, how would you do so? Do you think it would be practical to use this experiment on a large scale?

Chapter 3

Brief History of Macroeconomic Thought

Macroeconomics as a distinct field did not exist until the 1930s with the publication of John Maynard Keynes' *General Theory of Employment, Interest, and Money*. That is not to say economists did not think about aggregate outcomes until then. Adam Smith, for instance, discussed economic growth in *The Wealth of Nations* which was published over 150 years before Keynes wrote his book. Likewise, in the later part of the 18th century, John Baptiste Say and Thomas Malthus debated the self stabilizing properties of the economy in the short run.¹ However, macroeconomics as a field is a child of the Great Depression and it is where we start the discussion.

3.1 The Early Period: 1936-1968

Keynes published his seminal book in the throes of the Great Depression of 1936. Voluminous pages have been filled posing answers to the question, “What did Keynes really mean?” Unfortunately, since he died in 1946, he did not have much time to explain himself.² The year following the *General Theory's* debut, John Hicks offered a graphical interpretation of Keynes' work and it quickly became a go-to model for macroeconomic policy ([Hicks 1937](#)).

As time progressed, computational power continually improved. This allowed researchers to build statistical models containing the key economic aggregates (e.g. output, consumption, and investment) and estimate the relationships implied by Keynes' model. In the 1950s Lawrence Klein and his colleagues developed sophisticated econometric models to forecast the path of the economy. The most complicated of these models, [Klein and Goldberger \(1955\)](#), contained dozens of equations (each of which were inspired by some variant of the Keynesian theory) that were solved simultaneously. The motivation was that, after estimating these models, economists and policy makers could predict the dynamic path of the economic variables after a shock. For instance, if oil prices unexpectedly go up, one could take the estimated model and trace out the effects on output, consumption, inflation, and any other variable of interest. In the face of such shocks policy makers could choose the appropriate

¹[Econlib](#) provides a short and nice summary on Malthus.

²For more on Keynes see [Econlib](#).

fiscal and monetary policies to combat the effects of an adverse shock.

In contrast to the rich structure of the Klein model, it was a single equation which perhaps carried the most weight in policy circles: the “Phillips Curve.” [Phillips \(1958\)](#) showed a robust downward-sloping relationship between the inflation and unemployment rates. Economists reasoned that policy makers could conduct monetary and fiscal policy in such a way as to achieve a target rate of inflation and unemployment. The tradeoff was clear: if unemployment increased during a recession, the central bank could increase the money supply thereby increasing inflation but lowering unemployment. Consequently, decreasing unemployment was not costless, but the tradeoff between unemployment and inflation was clear, predictable and exploitable by policy makers. Until it wasn’t.

In a now famous 1968 presidential address to the American Economic Association, Milton Friedman explained why a permanent tradeoff between unemployment and inflation is theoretically dubious.³ The reason is that to achieve a lower unemployment rate the central bank would need to cut interest rates thereby increasing money supply and inflation. This increase in inflation in the medium to long run would increase nominal interest rates. To keep unemployment at this low level, there would need to be an even bigger expansion of the money supply and more inflation. This process would devolve into an inflationary spiral where more and more inflation would be needed to achieve the same level of unemployment. Friedman’s limits of monetary policy was a valid critique of the crudest versions of Keynesianism, but it was only the beginning of what was to come.

3.2 Blowing Everything Up: 1968-1981

In microeconomics you learn that supply and demand curves come from some underlying maximizing behavior of households and firms. Comparing various tax and subsidy policies necessitates going back to the maximization problem and figuring out what exactly changes. There was no such microeconomic behavior at the foundation of the first-generation Keynesian models; instead, decision rules for investment, consumption, labor supply, etc. were assumed rather than derived. For example, consumption was assumed to be a function of current disposable income. This was not the solution to a household’s optimization problem, but rather just seemed “natural.” Later generations of economists recognized this shortcoming and attempted to rectify it by providing microeconomic foundations for consumption-saving decisions ([Ando and Modigliani 1963](#)), portfolio choice ([Tobin 1958](#)), and investment ([Robert E. Lucas 1971](#)). While each of these theories improved the theoretical underpinnings of the latest vintages of the Keynesian model, they were typically analyzed in isolation. They

³[Friedman \(1968\)](#) and also see [Phelps \(1967\)](#) for a formal derivation.

were also analyzed in *partial equilibrium*, so, for instance, a consumer's optimal consumption and savings schedule was derived taking the interest rate as given. Moreover, econometric forecasting continued to be conducted in an ad hoc framework.

In "Econometric Policy Evaluation: A Critique," Robert Lucas launched a devastating critique on using these econometric models for policy evaluation (Lucas 1976). Lucas showed that while the *ad hoc* models might fit the data well, one cannot validly analyze the effects of policy within them. The reason is that the relationships between macroeconomic aggregates (e.g. output, wages, consumption) are the consequence of optimizing behavior. For example, if people consume about ninety percent of their income it might seem that an appropriate prediction of a \$1,000 tax cut is that people would consume \$900 of it. However, if this tax cut was financed by running a deficit, then the person receiving the tax cut might anticipate that the deficit will have to be repaid and will therefore save more than ten percent of the tax cut. Naively looking at the historical correlation between consumption and income would lead to an incorrect prediction of the effects of a tax cut on consumption.⁴ The magnitude of the consumption increase in this example is a function of the household's expectations about the future. If the household is myopic and does not realize the government will eventually raise taxes, then consumption will go up by more than if the household anticipates that its future tax burden will be higher. In summary, the relationship between macroeconomic variables cannot be assumed to be invariant to policy as in the Klein model, but instead actually depends on policy.

Lucas and his followers contended that individuals maximizing their utility or firms maximizing their profits would also optimize their expectations. What does it mean to "optimize" expectations? In Lucas' framework it means that households use all available information to them when making their forecasts. This has come to be known as "rational expectations" and is now ubiquitous in macroeconomics.

The implications of the rational expectations hypothesis were sweeping. First, it implied that predictable changes in monetary policy would not stimulate aggregate demand (Sargent and Wallace 1975). If everyone knows that the central bank is going to raise the money supply by ten percent, then all prices and wages will increase by ten percent simultaneously. Since there is no change in relative prices, expansionary monetary policy will not stimulate output. In terms of tax policy, governments have an incentive to promise to keep the tax rate on capital gains low to encourage investment in capital goods. Once the capital goods are completed, however, the government has an incentive to renege on its promise and tax the capital gains. Since a tax on a perfectly inelastic good like capital causes no deadweight loss, even a perfectly benevolent government would have an incentive to renege on its promise.

⁴A similar point was made by Barro (1974).

Rational individuals would anticipate the government's incentive structure and not ever invest in capital goods.⁵ Hence, what is optimal in a static sense is not optimal in a dynamic sense. This *time inconsistency* problem pervades many areas of policy and regulation and implies that any policy designed to trick people (even if it is for their own good) is doomed to fail.

These critiques led economists to be skeptical of the monetary and fiscal fine tuning policies of the 1960s and 70s, but the adverse economic conditions in the 1970s put the final nail in the Keynesian coffin. A mix of rising oil prices and slower productivity growth led to simultaneously high unemployment and inflation. The Phillips curve had shifted. If the relationship between unemployment and inflation was unstable then it could not necessarily be exploited by policy makers. Of course, this was Lucas' point: any policy designed to exploit a historical relationship between aggregate variables without understanding the microeconomic behavior that generated the relationship is misguided. By the early 1980s it was clear that the Keynesian orthodoxy was fading. In a 1979 paper, Bob Lucas and Tom Sargent put it best in discussing how to remedy Keynesian models:

In so doing, our intent will be to establish that the difficulties are fatal: that modern macroeconomic models are of no value in guiding policy, and that this condition will not be remedied by modifications along any line which is currently being pursued. [Lucas and Sargent \(1979\)](#).

The demise of Keynesian models was not in question. The relevant question was what would come to replace them.

3.3 Modern Macroeconomics: 1982-2016

In addition to the lack of microfoundations (i.e. the absence of firms and individuals maximizing objective functions), macroeconomic models suffered because models designed to address the short run question of business cycles were incompatible with models designed to address the long run questions of economic growth. While of course models are abstractions that will not capture every fine detail in the data, the inconsistency between short and long run models was especially severe. In 1982 Finn Kydland and Ed Prescott developed the "Real Business Cycle theory" which addressed this concern ([Kydland and Prescott 1982](#)). Kydland and Prescott's model extended the basic Neoclassical growth model to include a labor-leisure decision and random fluctuations in technology.⁶ The model consists of utility maximizing households and profit maximizing firms. Everyone has rational expectations and there are no

⁵See [Kydland and Prescott \(1977\)](#) for a discussion and more examples.

⁶The Neoclassical growth model was developed independently by [Cass \(1965\)](#) and [Koopmans \(1963\)](#). The version with randomly fluctuating technology was developed in [Brock and Mirman \(1972\)](#).

market failures. Kydland and Prescott showed that a large fraction of economic fluctuations could be accounted for by random fluctuations in total factor productivity alone. Total factor productivity (TFP) is simply the component of output that cannot be account for by observable inputs (e.g. capital, labor, intermediate goods). The idea that period-to-period fluctuations in output and other aggregates could be driven by changing productivity flew in the face of conventional wisdom which saw recessions and expansions as a product of changes in consumer sentiments or the mismanagement of fiscal and monetary policy. Their model also had the implication that pursuing activist monetary or fiscal policy to smooth out economic fluctuations is counterproductive.

While Kydland and Prescott's approach was certainly innovative, there were caveats to their stark conclusions. First, by construction, changes in TFP were the only source of business cycle movement in their model. How TFP is measured, however, depends on which inputs are included in the production function. A production function which includes capital, labor, and energy will give a different measure of TFP than a production function that includes only capital and labor. Second, because all market failures were assumed away, there was no role for an activist government by construction. Despite these potential shortcomings, Kydland and Prescott's model served as a useful benchmark and was the starting point for essentially all business cycle models up to the present day. Over the following decades, researchers developed the Real Business Cycle model to include different sources of fluctuations ([McGrattan, Rogerson, and Wright 1997](#) and [Greenwood, Hercowitz, and Krusell 2000](#)), productive government spending ([Baxter and King 1993](#)), and market failures such as coordination problems, sticky prices and wages, and imperfect information. Models built from the neoclassical core but which feature imperfectly flexible prices are often called New Keynesian models.⁷ Since the Great Recession, economists have worked hard to incorporate financial frictions and realistic financial intermediation into their models.

This broad class of models have come to be grouped by an acronym: DSGE. All of them are **D**ynamic in that households and firms make decisions over time. They are **S**tochastic which is just a fancy word for random. That is, the driving force of business cycles are random fluctuations in exogenous variables. Also, all of them are consistent with **G**eneral **E**quilibrium. We discuss general equilibrium later in the book, but for now think of it as a means of accounting. Markets have to clear, one person's savings is another's borrowing, etc. This accounting procedure guards against the possibility of misidentifying something as a free lunch and is pervasive through all of economics, not just macroeconomics.

DSGE models have become the common tools of the trade for academic researchers and central bankers all over the world. They incorporate many of the frictions discussed by

⁷For an early discussion see [Mankiw \(1990\)](#) and for a more up-to-date description see [Woodford \(2003\)](#).

Keynes and his followers but are consistent with rational expectations, long-run growth, and optimizing behavior. While some of the details are beyond the scope of what follows, all of our discussion is similar in spirit to these macroeconomic models.

At this point you may be wondering how macroeconomics is distinct from microeconomics. Following the advances in “microfoundations” of macro that followed Kydland and Prescott, it is now fairly accurate to say that all economics is microeconomics. When you want to know how labor supply responds to an increase in the income tax rate, you analyze the question with indifference curves and budget constraints rather than developing some sort of alternative economic theory. Similarly, macroeconomics is simply microeconomics at an aggregate level. The tools of analysis are exactly the same. There are preferences, constraints, and equilibrium just as in microeconomics, but the motivating questions are different. In the next chapter, we start to look at these motivating questions, in particular those related to long-run.

3.4 Summary

- As a distinct field of inquiry, macroeconomics began with Keynes’ *The General Theory* in 1936
- By the late 1960s, a consensus had emerged in macroeconomics, theoretically based on [Hicks \(1937\)](#)’s graphical interpretation of Keynes’ book and the Phillips Curve, and empirically implemented in the so-called large scale macroeconometric models.
- The 1970s witnessed an upheaval in macroeconomics. The end of the macroeconomic consensus of the 1960s came about because of an empirical failure (the breakdown of the Phillips Curve relationship) and theoretical inadequacies in the Keynesian models of the day. These models were not micro-founded and did not take dynamics seriously.
- A new consensus emerged in the 1980s. Loosely speaking, modern macroeconomic models can be divided into two camps – neoclassical / real business cycle models and New Keynesian models. Both of these are DSGE models in the sense that they are dynamic, feature an element of randomness (i.e. are stochastic), and study general equilibrium.
- Modern macroeconomics is microeconomics, but at a high level of aggregation.

Part II

The Long Run

Nobel Prize winning economist Robert Lucas once famously said that “Once you start to think about growth, it is difficult to think about anything else.” The logic behind Lucas’s statement is evident from a time series plot of real GDP, for example that shown in Figure 1.3. Visually it is difficult to even see the business cycle – what stands out most from the picture is trend growth. In a typical recession, real GDP declines by a couple of percentage points. This pales in comparison to what happens over longer time horizons. Since World War II, real GDP in the US has increased by a factor of 8. This means that real GDP has doubled roughly three times in the last 70 or so years. Given the power of compounding, the potential welfare gains from increasing the economy’s longer run rate of growth dwarf the potential gains from eliminating short run fluctuations. Understanding what drives growth is also key for understanding poverty in the developing world and how to lift the poorest of countries out of this poverty.

We begin the core of the book here in Part II by studying long run economic growth. We think of the long run as describing frequencies of time measured in decades. When economists talk about “growth,” we are typically referencing the rate of growth of GDP over these long stretches of time. This should not be confused with the usage of the word “growth” in much of the media, which typically references quarter-over-quarter percentage changes in real GDP.

Chapter 4 presents some basic facts about economic growth. The presentation is centered around the “Kaldor stylized facts” based on Kaldor (1957). Here we also present some facts concerning cross-country comparisons of standards of living. Chapter 5 presents the classical Solow model of economic growth, based on Solow (1956). Chapter 6 augments the basic Solow model with exogenous population and productivity growth. The main take-away from the Solow model is that sustained growth must primarily come from productivity growth, not from the accumulation of physical capital. This conclusion has important implications for policy. In Chapter 7, we use the basic Solow model from Chapter 5 to study the large differences in standards of living across countries. The principal conclusion of this analysis echoes the conclusion about the sources of long run trend growth – a key determinant in differences in GDP per capita across countries is productivity, with factor accumulation playing a more limited role. This too has important policy implications, particularly for those interested in lifting the developing world out of dire poverty. Chapter 8 studies an overlapping generations economy in which at any point in time there are two generations – young and old. Differently than the Solow model, young households choose saving to maximize lifetime utility, and thus the saving decision is endogenized. At least in some cases, the OLG economy is nevertheless quite similar to the Solow economy, although we are able to address some interesting questions related to intergenerational transfers and the role of government. Because Chapter 8 considers a micro-founded optimization model, it provides a

nice bridge to Part [III](#).

Chapter 4

Facts About Economic Growth

In this chapter we set the table for the growth model to come. Before jumping into the economic model, we start by describing some basic facts of economic growth. First, we look at the time series growth in the United States which is more or less representative of the average high-income country. Next, we look at economic growth over the world.

4.1 Economic Growth over Time: The Kaldor Facts

In an influential 1957 article Nicholas Kaldor listed a set of stylized facts characterizing the then relatively recent economic growth across countries ([Kaldor \(1957\)](#)).¹ “Stylized” means that these facts are *roughly* true over sufficiently large periods of time – they do not exactly hold, especially over short time frequencies. The “Kaldor Facts” continue to provide a reasonably accurate description of economic growth across developed countries including the United States.

1. Output per worker grows at a sustained, roughly constant, rate over long periods of time.

How rich are Americans today relative to several generations ago? To make such a comparison requires a standard unit of account. As we discussed in Chapter 1, it is common to use price indexes to distinguish changes in prices from changes in quantities. Hence, we focus on real, rather than nominal, GDP.

A natural measure of the productive capacity of an economy is real GDP per worker. GDP can go up either because there are more people working in an economy or because the people working in an economy are producing more. For thinking about an economy’s productive capacity, and for making comparisons across time, we want a measure of GDP that controls for the number of people working in an economy.

The log of real GDP per worker in the US is shown in Figure 4.1. Why do we plot this relationship in logs? GDP grows exponentially over time which implies the slope gets

¹Also see the [Wikipedia](#) entry on this.

steeper as time goes by. The log of an exponential function is a linear function which is much easier to interpret. The slope of a plot in the log is approximately just the growth rate of the series.

Figure 4.1: Real GDP per Worker in the US 1950-2011

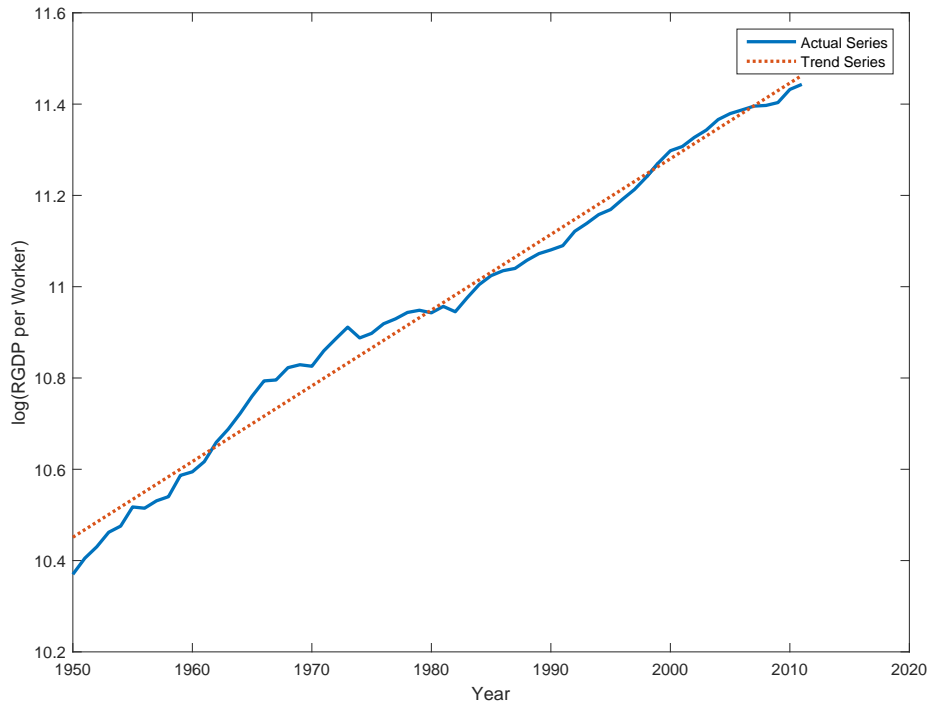

The figure also plots a linear time trend, which is depicted with the dotted straight line. While the actual series is occasionally below or above the trend line, it is clear that GDP per worker grows at a sustained and reasonably constant rate. The average growth rate over this period is about 1.7 percent annually. How does a 1.7 percent annual growth rate translate into absolute differences in income over time? A helpful rule of thumb is called the “Rule of 70.” The Rule of 70 (or sometimes rule of 72) is a way to calculate the approximate number of years it takes a variable to double. To calculate this, divide 70 by the average growth rate of this series. This gives you the approximate number of years it takes the variable to double. To see why it is called the “Rule of 70” consider the following example. Let Y_0 be a country’s initial level of income per person and suppose the annual rate of growth is g percent per year. We can find

how long it takes income per person to double by solving the following equation for t :

$$\begin{aligned}2Y_0 &= (1 + g)^t Y_0 \\ \Leftrightarrow 2 &= (1 + g)^t \\ \Leftrightarrow \ln 2 &= t \ln(1 + g).\end{aligned}$$

Provided g is sufficient small, $\ln(1 + g) \approx g$. $\ln 2$ is approximately equal to 0.7. Hence, 70 divided by the annual percent rate of growth equals the required time for a country's income per person to double. In the U.S. case, $t = 70/1.7 \approx 41$. This means that, at this rate, GDP per worker in the US will double twice every 80 years or so. Measured in current dollar terms, US GDP per capita in 1948 was about \$32,000. In 2016, it is \$93,000. In other words, over this 60 year period GDP per work in the US has doubled about 1.5 times.

Small differences in average growth rates can amount to large differences in standards of living over long periods of time. Suppose that US real GDP per capita were to continue to grow at 1.7 percent for the next one hundred years. Using the rule of 70, this means that real GDP per capita would double approximately 2.5 times over the next century. Suppose instead that the growth rate were to increase by a full percentage point to 2.7 percent per year. This would imply that real GDP per capita would double approximately 4 times over the next century, which is a substantial difference relative to double 2.5 times.

2. Capital per worker grows at a sustained, approximately constant, rate over long periods of time.

Figure 4.2 shows the time series of the log of capital per worker over the period 1950-2011 along with a linear time trend. Capital constitutes the plant, machinery, and equipment that is used to produce output. Similar to output per worker, the upward trend is unmistakable. Over the period under consideration, on average capital per worker grew about 1.5 percent per year, which is only slightly lower than the growth rate in output per capita.

Figure 4.2: Capital per worker in the US 1950-2011.

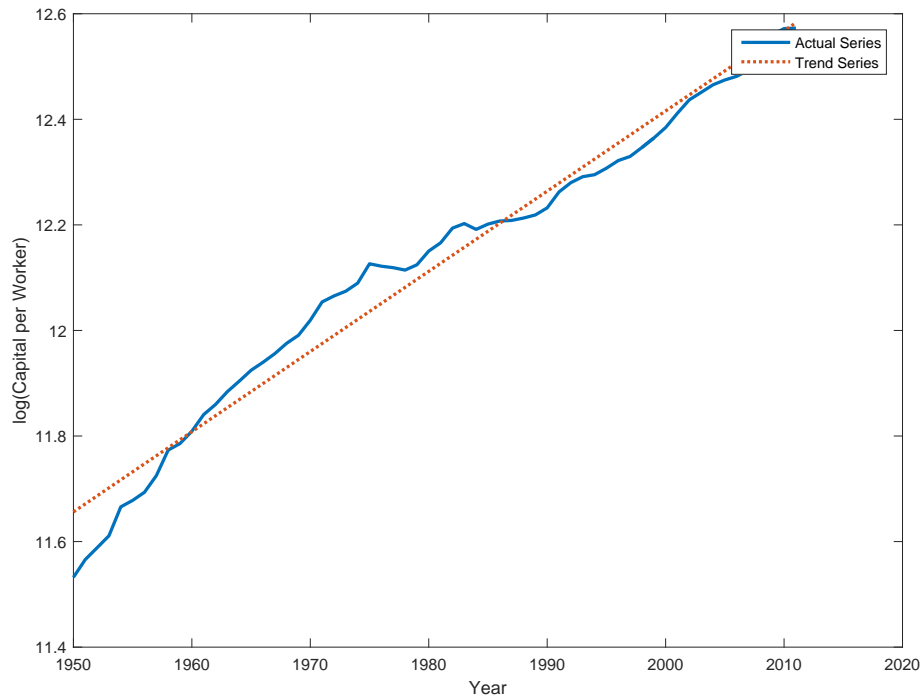

The fact that capital and output grow at similar rates leads to the third of Kaldor's facts.

3. The capital to output ratio is roughly constant over long periods of time.

If capital and output grew at identical rates from 1950 onwards, the capital to output ratio would be a constant. However, year to year the exact growth rates differ and, on average, capital grew a little slower than did output. Figure 4.3 plots the capital to output ratio over time. The capital to output ratio fluctuated around a roughly constant mean from 1950 to 1990, but then declined substantially during the 1990s. The capital output ratio picked up during the 2000s. Nevertheless, it is not a bad first approximation to conclude that the capital to output ratio is roughly constant over long stretches of time.

Figure 4.3: Capital to Output Ratio in the U.S. 1950–2011

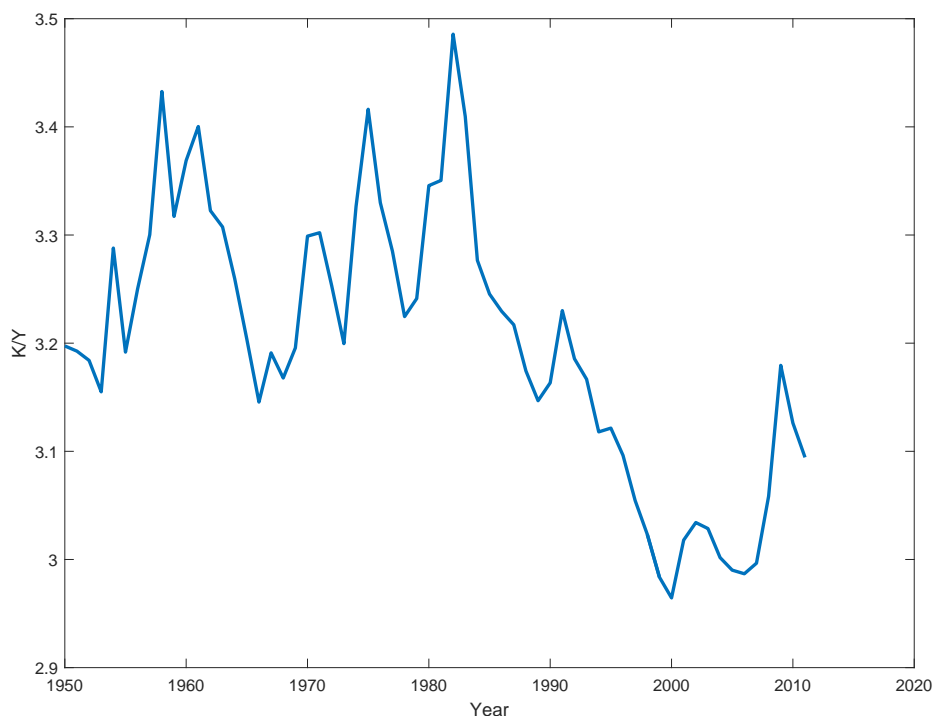

Over the entire time period, the ratio moved from 3.2 to 3.1 with a minimum value a little less than 3 and a maximum level of about 3.5. However, the ratio moves enough to say that the ratio is only *approximately* constant over fairly long periods of time.

4. Labor’s share of income is roughly constant over long periods of time..

Who (or what) earns income? This answer to this question depends on how broadly (or narrowly) we define the factors of production. For instance, should we make a distinction between those who collect rent from leasing apartments to those who earn dividends from owning a share of Facebook’s stock? Throughout most of this book, we take the broadest possible classification and group income into “labor income” and “capital income.” Clearly, when people earn wages from their jobs, that goes into labor income and when a tractor owner rents his tractor to a farmer, that goes into capital income. Classifying every type of income beyond these two stark cases is sometimes not as straightforward. For instance, a tech entrepreneur may own his computers (capital), but also supply his labor to make some type of software. The revenue earned by the entrepreneur might reasonably be called capital income or labor income. In practice, countries have developed ways to deal with the assigning income problem in their National Income and Product Accounts (also known by the acronym, NIPA). For now, assume that everything is neatly categorized as wage income or capital income.

Labor's share of income at time t equals total wage income divided by output, or:

$$LABSH_t = \frac{w_t N_t}{Y_t}.$$

Here w_t is the (real) wage, N_t total labor input, and Y_t output. Output must equal income, and since everything is classified as wage or capital income, capital's share is

$$CAPSH_t = 1 - LABSH_t.$$

Clearly, these shares are bounded below by 0 and above by 1. Figure 4.4 shows the evolution of the labor share over time.

Figure 4.4: Labor Share in the US 1950-2011.

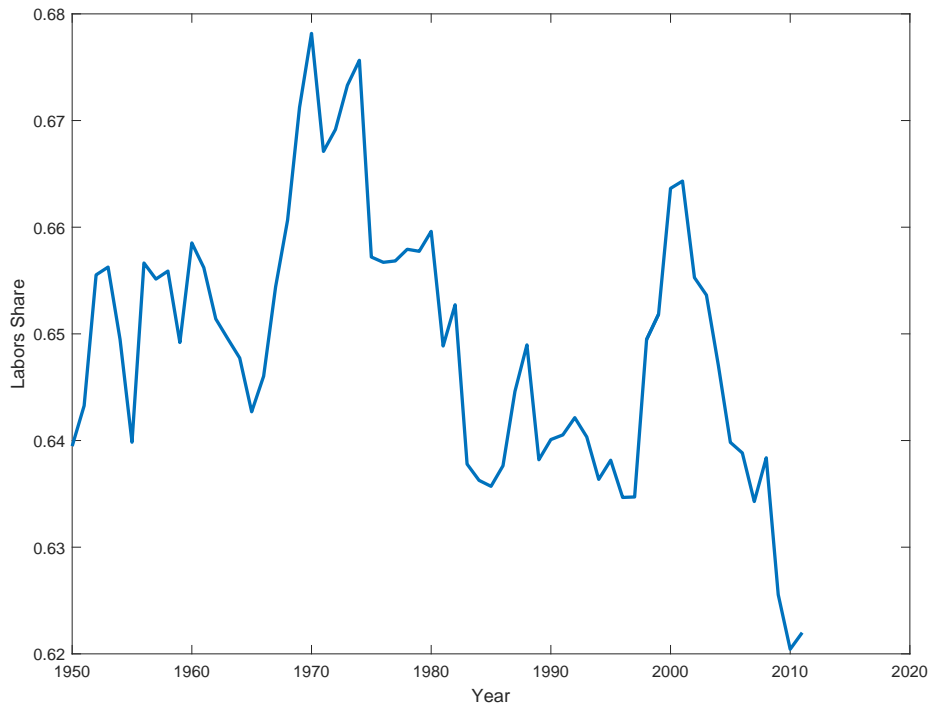

The labor share is always between a 0.62 and 0.7 with an average of 0.65. Despite a downward trend over the last decade, labor's share has been relatively stable. This also implies capital's share has been stable with a mean of about 0.35. The recent trends in factor shares have attracted attention from economists and we return to this later in the book, but for now take note that the labor share is relatively stable over long periods of time.

5. The rate of return on capital is relatively constant.

The return to capital is simply the value the owner gets from “renting” capital to someone else. For example, if I own tractors and lease them period-by-period to a farmer for \$10 per tractor, capital income is simply \$10 times the number of tractors. If a producer owns his or her own capital this “rent” is implicit. We will use R_t to denote the rental rate on capital and K_t the total stock of capital. We can infer the rate of return on capital from the information we have already seen. Start with the formula for capital’s share of income:

$$\begin{aligned} CAPSH_t &= 1 - LABSH_t \\ &= \frac{R_t K_t}{Y_t} \\ \Rightarrow \\ R_t &= (1 - LABSH_t) \frac{Y_t}{K_t} \end{aligned}$$

R_t is the rate of return on capital. Since we already have information on labor’s share and the capital to output ratio, we can easily solve for R_t . It’s also straightforward to see why, given previously documented facts, R_t ought to be approximately constant – $LABSH_t$ and $\frac{Y_t}{K_t}$ are both roughly constant, so the product of the two series ought also to be close to constant. The implied time series for R_t is displayed in Figure 4.5.

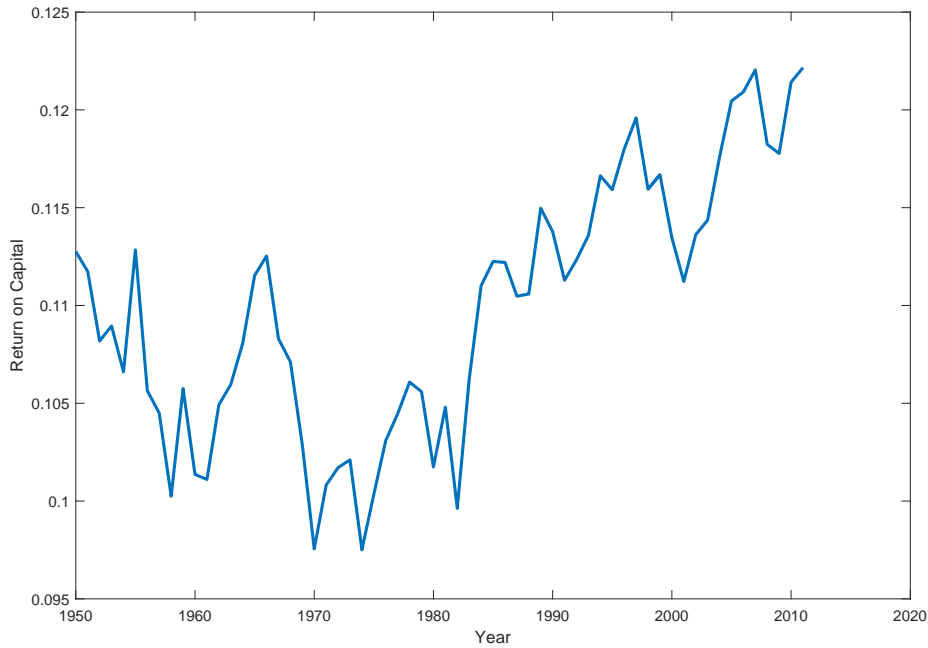

Figure 4.5: Return on capital in the US 1950-2011.

The rate of return on capital varies between 0.095 and 0.125 with an upwards trend since the mid 1980s. Therefore, the upward trend in capital's share since 2000 can be attributed more to the rise in the real return of capital rather than an increase in the capital to output ratio. The rate of return on capital is closely related to the real interest rate, as we will see in Part III. In particular, in a standard competitive framework the return on capital equals the real interest rate plus the depreciation rate on capital. If the depreciation rate on capital is roughly 0.1 per year, these numbers suggest that real interest rates are quite low on average. An interesting fact not necessarily relevant for

growth is that the return on capital seems to be high very recently in spite of extremely low real interest rates.

6. Real wages grow at a sustained, approximately constant, rate.

Finally, we turn our attention to the time series evolution of wages. By now, you should be able to guess what such a time path looks like. If the labor share is relatively stable and output per worker rises at a sustained rate, then wages *must* also be rising at a sustained rate. To see this, go back to the equation for the labor share. If Y_t/N_t is going up then N_t/Y_t must be going down. But the only way for the left hand side to be approximately constant is for the wage to increase over time. Figure 4.6 plots the log of wages against time and shows exactly that.

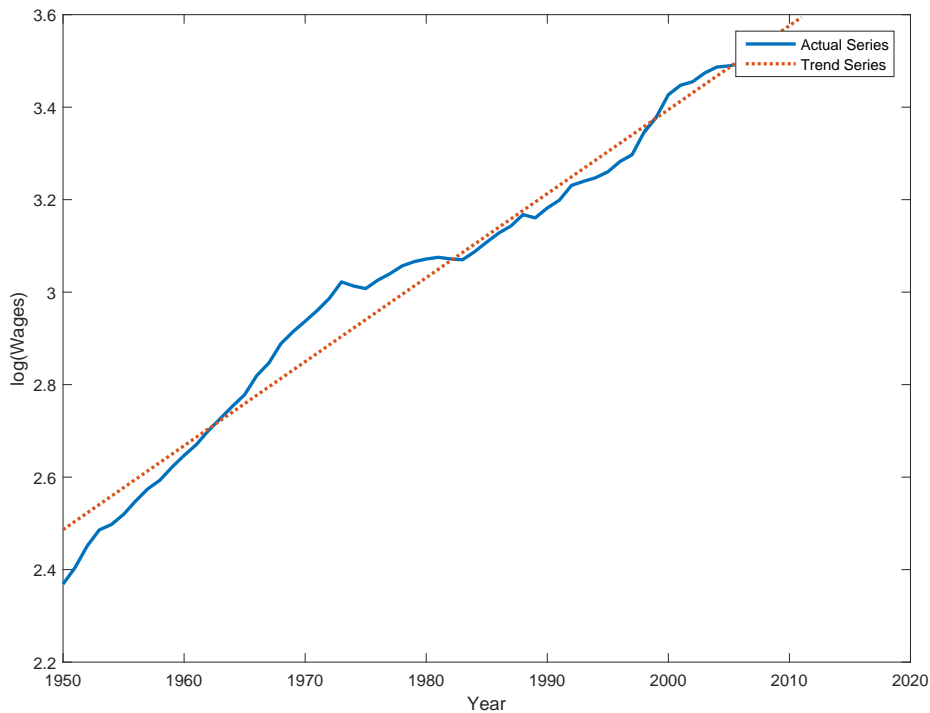

Figure 4.6: Wages in the US 1950-2011.

Annual wage growth averaged approximately 1.8 percent over the entire time period. Resembling output and capital per worker, there is a clear sustained increase. Moreover, wages grow at approximately the same rate as output per worker and capital per worker. The Kaldor facts can be summarized as follows. Wages, output per worker, and capital per worker grow at approximately the same sustained rate and the return on capital is approximately constant. All the other facts are corollaries to these. A perhaps surprising implication of these facts is that economic growth seems to benefit labor

(real wages rise over time) and not capital (the return on capital is roughly constant). Over the next two chapters we show that our benchmark model of economic growth is potentially consistent with all these facts.

4.2 Cross Country Facts

Kaldor's facts pertain to the economic progress of rich countries over long periods of time. However, there is immense variation in income across countries at any given point in time. Some of these countries have failed to grow at all, essentially remaining as poor today as they were forty years ago. On the other hand, some countries have become spectacularly wealthy over the last several decades. In this section we discuss the variation in economic performance across a subset of countries. We measure economic performance in terms of output per person. Because not everyone works, this is more indicative of average welfare across people than output per worker. This does not mean output per capita is necessarily an ideal way to measure economic well-being. Output per capita does not capture the value of leisure, nor does it capture many things which might impact both the quality and length of life. For example, output per capita does not necessarily capture the adverse consequences of crime or pollution. In spite of these difficulties, we will use output per capita as our chief measure of an economy's overall standard of living.

When comparing GDP across countries, a natural complication is that different countries have different currencies, and hence different units of GDP. In the analysis which follows, we measure GDP across country in terms of US dollars using a world-wide price index that accounts for cross-country differences in the purchasing power of different currencies.

1. There are enormous variations in income across countries.

Table 4.1 shows the differences in the level of output per person in 2011 for a selected subset of countries.

Table 4.1: GDP Per Capita for Selected Countries

		GDP per Person
High income countries		
	Canada	\$35,180
	Germany	\$34,383
	Japan	\$30,232
	Singapore	\$59,149
	United Kingdom	\$32,116
	United States	\$42,426
Middle income countries		
	China	\$8,640
	Dominican Republic	\$8,694
	Mexico	\$12,648
	South Africa	\$10,831
	Thailand	\$9,567
	Uruguay	\$13,388
Low income countries		
	Cambodia	\$2,607
	Chad	\$2,350
	India	\$3,719
	Kenya	\$1,636
	Mali	\$1,157
	Nepal	\$1,281

Notes: This data comes from the Penn World Tables, version 8.1. The real GDP is in terms of chain-weighted PPPs.

In purchasing power parity terms, the average person in the United States was 36.67 times ($\$42,426/\$1,157$) richer than the average person in Mali. This is an enormous difference. In 2011, 29 countries had an income per capita of five percent or less of that in the U.S. Even among relatively rich countries, there are still important differences in output per capita. For example, in the US real GDP per capita is about 30 percent larger than it is in Great Britain and about 25 percent larger than in Germany.

2. There are growth miracles and growth disasters.

Over the last four decades, some countries have become spectacularly wealthy. The people of Botswana, for instance, subsisted on less than two dollars a day in 1970, but their income increased nearly 20 fold over the last forty years.

Table 4.2: Growth Miracles and Growth Disasters

Growth Miracles				Growth Disasters			
	1970 Income	2011 Income	% change		1970 Income	2011 Income	% change
South Korea	\$1918	\$27,870	1353	Madagascar	\$1,321	\$937	-29
Taiwan	\$4,484	\$33,187	640	Niger	\$1,304	\$651	-50
China	\$1,107	\$8,851	700	Burundi	\$712	\$612	-14
Botswana	\$721	\$14,787	1951	Central African Republic	\$1,148	\$762	-34

Notes: This data comes from the Penn World Tables, version 8.1. The real GDP is in terms of chain-weighted PPPs.

As Table 4.2 shows, the countries of East Asia are well represented in the accounting of growth miracles. On the other hand, much of continental Africa has remained mired in poverty. Some countries, like those shown under the growth disasters column actually saw GDP per person decline over the last forty years. Needless to say, a profound task facing leaders in developing countries is figuring out how to get to the left side of this table and not fall on the right side.

3. There is a strong, positive correlation between income per capita and human capital.

Human capital refers to the stock of knowledge, social attributes, and habits possessed by individuals or groups of individuals. It is capital in the sense that human capital must itself be accumulated over time (i.e. it is not something with which an individual is simply endowed), is useful in producing other goods, and does not get completely used up in the process of producing other goods. Unlike physical capital, it is intangible and possessed by individuals or groups of individuals. As such, measuring what economists call “human capital” is rather difficult. A natural proxy for human capital is years of education. On one hand, calculating the average number of years citizens spend in school seems like a reasonable proxy, but what if teachers do not show up to school? What if there are no books or computers? Clearly, the *quality* of education matters as much as the *quantity* of education. While imperfect, economists have devised measures to deal with cross country heterogeneity in quality. With that caveat in mind, Figure 4.7 shows how the level of human capital varies with income per person.

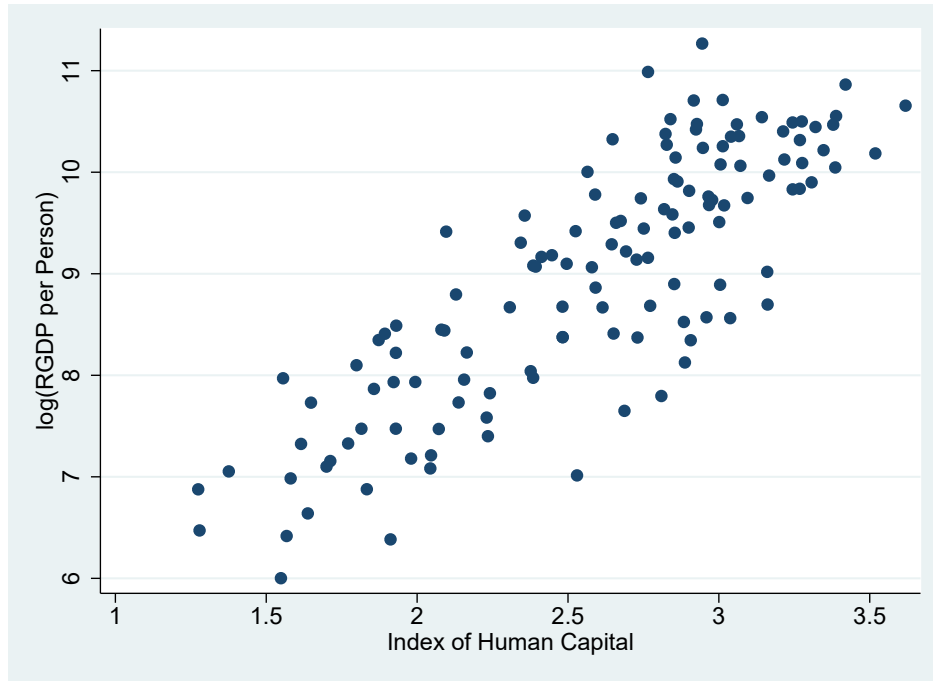

Figure 4.7: Relationship Between Human Capital and Income per Person

As the level of human capital per person increases, income per person also increases. This does not mean that more education causes an increase in income. Indeed, the arrow of causation could run the other direction. If education is a normal good, then people in richer countries will demand more education. However, it is reasonable to think that people who know how to read, write, and operate a computer are more productive than those who do not. Understanding the direction of causation is difficult, but carries very important policy implications.

4.3 Summary

- In this chapter we covered a number of cross country and within country growth facts.
- The main time series facts are that output, capital, and wages grow at a sustained rate and that the capital to output ratio and real interest rate do not have sustained growth.
- From a cross country perspective there are enormous variations in living standards.
- Rich countries tend to have more educated populations.

Questions for Review

1. Write down and briefly discuss the six Kaldor stylized facts about economic growth in the time series dimension.
2. Write down and discuss the three stylized facts about economic growth in the cross-sectional dimension.
3. It has been widely reported that income inequality within the US and other industrialized countries is growing. Yet one of the stylized facts is that capital does not seem to benefit from economic growth (as evidenced by the approximate constancy of the return to capital across time). If this is the case, what do you think must be driving income inequality?

Exercises

1. [**Excel Problem**] Download quarterly data on output per worker in the nonfarm business sector for the US for the period 1947 through 2016. You can do so [here](#).
 - (a) Take natural logs of the data (which appears as an index) and then compute first differences of the natural logs (i.e. compute the difference between the natural log of the index in 1947q2 with the value in 1947q1, and so on). What is the average value of the first difference over the entire sample? To put this into annualized percentage units, you may multiply by 400.
 - (b) Compute the average growth rate by decade for the 1950s, 1960s, 1970s, 1980s, 1990s, 2000s, and 2010s (even though this decade isn't complete). Does the average growth rate look to be constant by decade here? What pattern do you observe?
2. [**Excel Problem**] In this problem we investigate the relationship between the size of government and growth in GDP per person between 1960-2010 for the following countries: Australia, Canada, Germany, Japan, Spain, and the United States.
 - (a) Go to this Saint Louis FRED [page](#), and download the "Share of Government Consumption at Current Purchasing Power Parities" for the relevant subset of countries. Plot the trends of government's share over time for the countries. Comment on the trends. Do they seem to be moving in the same direction for all the countries?
 - (b) Next, we have to construct real GDP per capita. First, go to this, [page](#), and download "Expenditure-Side Real GDP at Chained Purchasing

Power Parities” for the subset of countries. Next go to this [page](#), and download “Population” for each country. Real GDP per capita is Real GDP divided by population. Calculate real GDP per person at each point in time for each country. Plot the log level of real GDP per capita over time for each country. Do the countries appear to be getting closer together or fanning out?

- (c) For every country, calculate the average share of government expenditures and the average rate of growth in output per worker over ten years. For example, calculate the average share of government expenditures in Canada from 1960-1969 and the average growth rate in GDP per capita between 1961-1970. You will have five decade pairs for each country. Once these are constructed, create a scatter plot of real GDP growth on the vertical axis and government’s share of expenditure on the horizontal axis. What is the correlation between these variables?

Chapter 5

The Basic Solow Model

The Solow Model is the principal model for understanding long run growth and cross-country income differences. It was developed by Robert Solow in [Solow \(1956\)](#), work for which he would later win a Nobel Prize.

This chapter develops the simplest version of the Solow model. The theoretical framework is rather simple but makes powerful predictions that line up well with the data. We do not explicitly model the microeconomic underpinnings of the model. The key equations of the model are an aggregate production function, a consumption/saving function, and an accumulation equation for physical capital. In the sections below, we present the equations summarizing the model and graphically work through some implications of the theory.

5.1 Production, Consumption, and Investment

The Solow model presumes that there exists an aggregate production function which maps capital and labor into output. Labor is denominated in units of time. Capital refers to something which (i) must itself be produced, (ii) helps you produce output, and (iii) does not get fully used up in the production process. Capital and labor are said to both be factors of production. Capital and labor share the similarity that both help you produce output. They differ in that capital is a *stock* whereas labor is a *flow* concept. They also differ in that labor/time is an *endowment* – there is nothing one can do to increase the number of hours available to work in a day, for example. In contrast, capital can be *accumulated*. As an example, suppose that your output is lawns mowed, your capital is your lawn mower, and your labor is time spent mowing. Each period, there is a fixed amount of hours in the day in which you can spend mowing – this is the endowment feature of labor input. Furthermore, the amount of hours available tomorrow is independent of how many hours you spend mowing today – in other words, how many hours you worked in the past doesn't influence how many hours you can work in the future. This is the flow feature of labor. Capital is different in that how much capital you had in the past influences how much capital you'll have in the future. If you had two mowers yesterday, you'll probably still have two mowers tomorrow (or nearly the equivalent of two mowers tomorrow should the mowers experience some depreciation).

This is the stock feature of capital – how much you had in the past influences how much capital you have in the present and future. Furthermore, you can accumulate capital – you can go to Home Depot and buy another mower if you want to increase your future productive capacity.¹

Let us now turn to a formal mathematical description of the aggregate production function. Denote K_t as the stock of capital and N_t as the total time spent working in period t . Let Y_t denote output produced in period t . Suppose that there is a single, representative firm which leases labor and capital from a single, representative household each period to produce output. The production function is given by:

$$Y_t = A_t F(K_t, N_t). \quad (5.1)$$

Here A_t is an exogenous variable which measures productivity. It is exogenous and can in principle vary across time. However, we shall assume that if it does change, it does so permanently, meaning that future values of A_{t+j} , for $j > 1$, equal the current value, A_t . Therefore, to simplify notation we will drop the t subscript and simply denote this exogenous variable with A . $F(\cdot)$ is a function which relates capital and labor into output. The bigger is A , the more Y_t you get for given amounts of K_t and N_t – i.e. you are more efficient at turning inputs into output. The function $F(\cdot)$ is assumed to have the following properties: $F_K > 0$ and $F_N > 0$ (i.e. the marginal products, or first partial derivatives with respect to each argument, are always positive, so more of either input means more output); $F_{KK} < 0$, $F_{NN} < 0$ (i.e. there are diminishing marginal products in both factors, so more of one factor means more output, but the more of the factor you have, the less an additional unit of that factor adds to output); $F_{KN} > 0$ (i.e. if you have more capital, the marginal product of labor is higher); and $F(\gamma K_t, \gamma N_t) = \gamma F(K_t, N_t)$, which means that the production function has constant returns to scale (i.e. if you double both inputs, $\gamma = 2$, you double output). Finally, we assume that both capital and labor are necessary to produce, which means that $F(0, N_t) = F(K_t, 0) = 0$. An example functional form for $F(\cdot)$ which we will use throughout the course is the Cobb-Douglas production function:

$$F(K_t, N_t) = K_t^\alpha N_t^{1-\alpha}, \quad \text{with } 0 < \alpha < 1. \quad (5.2)$$

¹Although we are here focusing on physical capital (e.g. mowers), the logic also applies to human capital, which was discussed briefly in Chapter 4. For example, suppose that you are in the business of air conditioner repair. You can go to school to learn how to repair air conditioners. This stock of knowledge helps you produce output (repaired air conditioners). Using your stock of knowledge on Tuesday doesn't prevent you from also using your stock of knowledge on Wednesday. Furthermore, you can go back to school to learn more about air conditioners so as to increase your productive capacity. This knowledge you accumulate is not tangible like physical capital (e.g. lawn mowers), but it is like physical capital in that it is a stock and in that it can be accumulated.

Example

Suppose that the production function is Cobb-Douglas, as in (5.2). Let's verify that this production function satisfies the properties laid out above. The first partial derivatives are:

$$\begin{aligned}F_K(K_t, N_t) &= \alpha K_t^{\alpha-1} N_t^{1-\alpha} \\F_N(K_t, N_t) &= (1 - \alpha) K_t^\alpha N_t^{-\alpha}.\end{aligned}$$

Since $0 < \alpha < 1$, and K_t and N_t cannot be negative, the marginal products of capital and labor are both positive. Now, let's look at the second derivatives. Differentiating the first derivatives, we get:

$$\begin{aligned}F_{KK}(K_t, N_t) &= \alpha(\alpha - 1) K_t^{\alpha-2} N_t^{1-\alpha} \\F_{NN}(K_t, N_t) &= -\alpha(1 - \alpha) K_t^\alpha N_t^{-\alpha-1} \\F_{KN}(K_t, N_t) &= (1 - \alpha) \alpha K_t^{\alpha-1} N_t^{-\alpha}.\end{aligned}$$

Again, since $0 < \alpha < 1$, F_{KK} and F_{NN} are both negative, while $F_{KN} > 0$. Now, let's verify the constant returns to scale assumption.

$$\begin{aligned}F(\gamma K_t, \gamma N_t) &= (\gamma K_t)^\alpha (\gamma N_t)^{1-\alpha} \\&= \gamma^\alpha K_t^\alpha \gamma^{1-\alpha} N_t^{1-\alpha} \\&= \gamma K_t^\alpha N_t^{1-\alpha}.\end{aligned}$$

Effectively, since the exponents on K_t and N_t sum to one, scaling them by a factor γ simply scales the production function by the same factor. If the exponents summed to less than 1, we would say that the production function has decreasing returns to scale. If the exponents summed to greater than 1, we would say that the production function had increasing returns to scale. Finally, let's verify that both inputs are necessary for any output to be produced:

$$\begin{aligned}F(0, N_t) &= 0^\alpha N_t^{1-\alpha} \\F(K_t, 0) &= K_t^\alpha 0^{1-\alpha}.\end{aligned}$$

Since 0 raised to any power other than 0 is 0, as long as $\alpha \neq 1$ or $\alpha \neq 0$, both inputs are necessary for production.

The optimization problem of the firm is to choose capital and labor so as to maximize

the difference between revenue and total costs or, more simply, maximize profit (denoted by Π_t). Stated in math, the problem is:

$$\max_{K_t, N_t} \Pi_t = AF(K_t, N_t) - w_t N_t - R_t K_t. \quad (5.3)$$

where w_t denotes the real wage paid to labor and R_t denotes the real return to capital. Note that revenue equals output rather than output times a price. The output good, let's say fruit, is the unit in which every other price is denominated. For example, if $w_t = 3$, workers receive three units of fruit per unit of time spent working.² The first order conditions for the representative firm are:

$$w_t = AF_N(K_t, N_t) \quad (5.4)$$

$$R_t = AF_K(K_t, N_t). \quad (5.5)$$

These conditions say that the firm ought to hire capital and labor up until the point at which the marginal benefit of doing so (the marginal product of capital or labor) equals the marginal cost of doing so (the factor price). As you will see in a question at the end of the chapter, the assumption of constant returns to scale implies that profit is equal to zero and the number of firms is indeterminate. Consequently, nothing is lost by assuming one representative firm.

There exists a representative household in the economy. This household is endowed with time, N_t , and an initial stock of capital, K_t . It earns income from supplying capital and labor to the firm, $w_t N_t + R_t K_t$. It can consume its income, C_t , or invest some of it in additional capital, I_t . Formally, its budget constraint is:

$$C_t + I_t \leq w_t N_t + R_t K_t + \Pi_t. \quad (5.6)$$

Although separate decision-making units, the household owns the firm through common stock, and Π_t is a dividend payment equal to any profit earned by the firm. As discussed above, however, the firm earns no profit under the assumption of constant returns to scale, and $w_t N_t + R_t K_t = Y_t$. This simply says that total income equals total output. (5.6) holding with equality (i.e. replacing the \leq with a $=$ sign) means that total expenditure, $C_t + I_t$, equals total income which equals total output. In other words:

$$Y_t = C_t + I_t. \quad (5.7)$$

²When we introduce money later in this book, we will denominate all goods in terms of money, i.e. in nominal, rather than real, terms.

Although the initial level of capital, K_t , is given, future levels of capital can be influenced through investment. In particular, investment in period t yields new capital in period $t + 1$. Furthermore, some existing capital depreciates (or becomes obsolete) during production. Formally, capital accumulates according to:

$$K_{t+1} = I_t + (1 - \delta)K_t. \quad (5.8)$$

We refer to (5.8) as the capital accumulation equation, or sometimes as a “law of motion” for capital. This equation says that your capital stock in $t + 1$ equals your investment in period t plus the non-depreciated stock of capital with which you started, where $0 < \delta < 1$ is the depreciation rate (the fraction of the capital stock that goes bad or becomes obsolete each period). In writing (5.8), we have implicitly assumed that one unit of investment yields one unit of future capital. We could have this transformation be greater than or less than one without fundamentally changing anything. We also assume that there is a one period delay between when investment is undertaken and when the new capital becomes productive. Because capital must itself be produced, there must be some delay between when investment is undertaken and when the capital becomes usable. For example, if a firm decides to build a new manufacturing plant, it cannot use the new plant to produce output in the period in which it decided to build the new plant because it takes some time for the new plant to be built. We could assume a longer than one period delay without fundamentally changing any of the subsequent analysis.

Let’s return to the lawn mower example given above. Suppose your capital stock is ten lawn mowers, $K_t = 10$. Suppose that the depreciation rate is $\delta = 0.1$. Suppose you produce 3 units of output in period t , $Y_t = 3$. If you choose to consume all of your output in period t , $C_t = 3$, you will have $I_t = 0$, so you will have only $K_{t+1} = 9$ lawn mowers in the next period. If instead you consume two units of output in period t , $C_t = 2$, you will have $I_t = 1$ and hence $K_{t+1} = 10$, the same as it was in period t . If you consume only one unit of output, $C_t = 1$, then you’ll have $I_t = 2$ and hence $K_{t+1} = 11$. The benefit of not consuming all your output in period t is that it leaves you more capital in $t + 1$, which means you can produce more output in the future (since $F_K > 0$), which affords you the opportunity to consume more in the future. Hence, the decision of how much to invest (equivalently, how much to not consume, i.e. how much to save) is fundamentally an *intertemporal* decision about trading off current for future consumption.

The Solow model assumes that investment is a constant fraction of output. In particular,

let $0 < s < 1$ denote the saving rate (equivalently, the investment rate):

$$I_t = sY_t. \quad (5.9)$$

Combining (5.9) with (5.7) implies:

$$C_t = (1 - s)Y_t. \quad (5.10)$$

The Solow model is therefore assuming that the economy as a whole consumes a constant fraction of its output each period, investing the other fraction. The assumption of a constant saving rate is not, in general, going to be optimal from a microeconomic perspective in the short run. But over long periods of time, it seems consistent with the data, as documented in Chapter 4.

Finally, we assume that the household supplies labor inelastically. This means that the amount of time the household spends working is independent of the factor price to supplying labor, w_t . Hence, we can take the overall quantity of N_t as exogenous and fixed across time. This is also not consistent with optimizing microeconomic behavior in the short run, but is again consistent with long run trends, where total labor hours per capita is roughly trendless.

All together, the Solow model is characterized by the following equations all simultaneously holding:

$$Y_t = AF(K_t, N_t) \quad (5.11)$$

$$Y_t = C_t + I_t \quad (5.12)$$

$$K_{t+1} = I_t + (1 - \delta)K_t \quad (5.13)$$

$$I_t = sY_t \quad (5.14)$$

$$w_t = AF_N(K_t, N_t) \quad (5.15)$$

$$R_t = AF_K(K_t, N_t). \quad (5.16)$$

This is six equations and six endogenous variables – Y_t , C_t , I_t , K_{t+1} , w_t , and R_t .³ N_t , K_t , and A are exogenous variables (taken as given) and s and δ are parameters.

It is useful to think about an example economy. Suppose that output, Y_t , is units of fruit. Capital, K_t , is trees. Labor, N_t , is hours spent picking fruit from the trees. Trees have to be planted from unconsumed fruit, and we assume that one unit of unconsumed fruit yields one tree in the next period. Labor and capital are paid in terms of units of fruit – so the units of

³The reason that (5.10) is not listed here is because it is redundant given that both (5.12) and (5.14) must hold.

w_t and R_t are units of fruit. So, the household “wakes up” in period t with a stock of capital (say 10 trees) and an endowment of time (say 24 hours). It leases its trees to a firm for R_t fruits per tree, and follows a rule of thumb where it supplies a fixed amount of labor (say $N_t = 8$ hours) for w_t fruits per unit of time. The firm transforms the trees and time into fruit. The household’s total income equals total fruit production, Y_t . The household follows a rule of thumb in which it consumes a constant fraction of its income (say 80 percent, so $s = 0.2$), and plants the remainder in the ground, which yields additional trees (capital) in the future.

Equations (5.11), (5.13), and (5.14) can be combined into one central equation describing the evolution of capital over time. In particular, we have $I_t = sAF(K_t, N_t)$ from combining (5.11) with (5.14). Plugging it into (5.13), we are left with:

$$K_{t+1} = sAF(K_t, N_t) + (1 - \delta)K_t. \quad (5.17)$$

This equation describes the evolution of K_t . Given an exogenous current value of K_t , it tells you how much K_{t+1} an economy will have, given exogenous values for A and N_t , and values for the parameters s and δ . It is helpful to write this in terms of capital per work. Divide both sides of (5.18) by N_t :

$$\frac{K_{t+1}}{N_t} = \frac{sAF(K_t, N_t)}{N_t} + (1 - \delta)\frac{K_t}{N_t}. \quad (5.18)$$

Let’s define $k_t \equiv K_t/N_t$. We will call this variable capital per worker, or sometimes capital per capita (since the model has inelastically supplied labor, capital per worker and capital per capita will be the same up to a scale factor reflecting the labor force participation rate, which we are not modeling here).⁴ Using the properties of the production function, in particular the assumption that it is constant returns to scale, we can write:

$$\frac{F(K_t, N_t)}{N_t} = F\left(\frac{K_t}{N_t}, \frac{N_t}{N_t}\right) = F(k_t, 1).$$

So as to economize on notation, we will define $f(k_t) \equiv F(k_t, 1)$ as the per worker production function. We can therefore write (5.18) as:

$$\frac{K_{t+1}}{N_t} = sAf(k_t) + (1 - \delta)k_t.$$

Multiply and divide the left hand side by N_{t+1} , re-arranging terms so as to write it in terms

⁴This is admittedly somewhat poor terminology because taken literally there is only one worker in the economy (the representative household) which supplies an exogenous amount of time in the form of labor to the firm. Therefore, it would be more appropriate to refer to k_t as capital per labor input, but we will henceforth engage in an abuse of terminology and call it capital per worker.

of capital per worker:

$$\frac{K_{t+1}}{N_{t+1}} \frac{N_{t+1}}{N_t} = sAf(k_t) + (1 - \delta)k_t.$$

Since we are assuming that labor is constant across time, this means that $N_{t+1}/N_t = 1$. So we can write:

$$k_{t+1} = sAf(k_t) + (1 - \delta)k_t. \quad (5.19)$$

Equation (5.19) is the central equation of the Solow model. It describes how capital per worker evolves over time, given an initial value of the capital stock, an exogenous value of A , and parameter values s and δ . Once we know the dynamics of k_t , we can back out the dynamics of all other variables. We can define y_t , c_t , and i_t as output, consumption, and investment per worker. In terms of k_t , these can be written:

$$y_t = Af(k_t) \quad (5.20)$$

$$c_t = (1 - s)Af(k_t) \quad (5.21)$$

$$i_t = sAf(k_t). \quad (5.22)$$

To get expressions for w_t and R_t in terms of k_t , we need to use something called Euler's theorem, explained below in the Mathematical Diversion. The rental rate and wage can be written:

$$R_t = Af'(k_t) \quad (5.23)$$

$$w_t = Af(k_t) - k_t Af'(k_t). \quad (5.24)$$

Mathematical Diversion

Referring back to the assumed mathematical properties of the production function, we assumed that the production function has constant returns to scale. In words, this means that doubling both inputs results in a doubling of output. A fancier term for constant returns to scale is to say that the function is homogeneous of degree 1. More generally, a function is homogeneous of degree ρ if:

$$F(\gamma K_t, \gamma N_t) = \gamma^\rho F(K_t, N_t).$$

where $\gamma = 1$ corresponds to the case of constant returns to scale. $\gamma < 1$ is what is called decreasing returns to scale (meaning that doubling both inputs results in a less than doubling of output), while $\gamma > 1$ is increasing returns to

scale (doubling both inputs results in a more than doubling of output). Euler's theorem for homogeneous functions states (see [Mathworld \(2016\)](#)) if a function is homogeneous of degree ρ , then:

$$\rho F(K_t, N_t) = F_K(K_t, N_t)K_t + F_N(K_t, N_t)N_t. \quad (5.25)$$

If $\rho = 1$ (as we have assumed), this says that the function can be written as the sum of partial derivatives times the factor being differentiated with respect to. To see this in action for the Cobb-Douglas production function, note:

$$\begin{aligned} K_t^\alpha N_t^{1-\alpha} &= \alpha K_t^{\alpha-1} N_t^{1-\alpha} K_t + (1-\alpha) K_t^\alpha N_t^{-\alpha} N_t \\ &= \alpha K_t^\alpha N_t^{1-\alpha} + (1-\alpha) K_t^\alpha N_t^{1-\alpha} \\ &= K_t^\alpha N_t^{1-\alpha} (\alpha + 1 - \alpha) = K_t^\alpha N_t^{1-\alpha}. \end{aligned}$$

Euler's theorem also states that, if a function is homogeneous of degree ρ , then its first partial derivatives are homogeneous of degree $\rho - 1$. This has the implication, for example, that:

$$F_K(\gamma K_t, \gamma N_t) = \gamma^{\rho-1} F_K(K_t, N_t).$$

Since we are working with a constant returns to scale function, meaning $\rho = 1$, this means that you can scale both inputs by a factor and not change the partial derivative. Concretely, this means that:

$$F_K(K_t, N_t) = F_K\left(\frac{K_t}{N_t}, \frac{N_t}{N_t}\right) = f'(k_t). \quad (5.26)$$

In other words, (5.26) means that the partial derivative of $F(\cdot)$ with respect to K_t is the same thing as the partial derivative of $f(\cdot)$ with respect to k_t . This yields (5.23) above. To get (5.24), use this result plus (5.25) to get:

$$\begin{aligned} F(K_t, N_t) &= f'(k_t)K_t + F_N(K_t, N_t)N_t & (5.27) \\ f(k_t) &= f'(k_t)k_t + F_N(K_t, N_t) \\ F_N(K_t, N_t) &= f(k_t) - f'(k_t)k_t. \end{aligned}$$

The second line in (5.27) follows by dividing both sides of the first line by N_t . The last line is just re-arrangement. Since $w_t = AF_N(K_t, N_t)$, using the last line of (5.27) we get the expression in (5.24).

Example Suppose that we have the Cobb-Douglas production function. The

central equation of the Solow model can be written:

$$k_{t+1} = sAk_t^\alpha + (1 - \delta)k_t. \quad (5.28)$$

The other variables are determined as a function of k_t . These can be written:

$$y_t = Ak_t^\alpha \quad (5.29)$$

$$c_t = (1 - s)Ak_t^\alpha \quad (5.30)$$

$$i_t = sAk_t^\alpha \quad (5.31)$$

$$R_t = \alpha Ak_t^{\alpha-1} \quad (5.32)$$

$$w_t = (1 - \alpha)Ak_t^\alpha. \quad (5.33)$$

5.2 Graphical Analysis of the Solow Model

We will use both graphs and math to analyze the Solow model. We will start with graphical analysis. Consider the central equation of the Solow model, (5.19). Let's graph k_{t+1} as a function of k_t (which is predetermined in period t and therefore exogenous). If $k_t = 0$, then $k_{t+1} = 0$ given that we assume capital is necessary for production. This means that in a graph with k_t on the horizontal axis and k_{t+1} on the vertical axis, the graph starts in the origin. How will k_{t+1} vary as k_t changes? To see this, let's take the derivative of k_{t+1} with respect to k_t :

$$\frac{dk_{t+1}}{dk_t} = sAf'(k_t) + (1 - \delta). \quad (5.34)$$

Equation (5.34) is an expression for the slope of the graph of k_{t+1} against k_t . The magnitude of this slope depends on the value of k_t . Since $f'(k_t)$ is positive and $\delta < 1$, the slope is positive – so k_{t+1} is increasing in k_t . Since $f''(k_t) < 0$, the term $sAf'(k_t)$ gets smaller as k_t gets bigger. This means that k_{t+1} is an increasing function of k_t , but at a decreasing rate. Let's assume two additional conditions, which are sometimes called “Inada conditions.” In particular, assume that:

$$\lim_{k_t \rightarrow 0} f'(k_t) = \infty \quad (5.35)$$

$$\lim_{k_t \rightarrow \infty} f'(k_t) = 0. \quad (5.36)$$

In words, (5.35) says that the marginal product of capital is infinite when there is no capital, while (5.36) says that the marginal product of capital goes to zero as the capital stock per worker gets infinitely large. These conditions together imply that $\frac{dk_{t+1}}{dk_t}$ starts out

at the origin at positive infinity but eventually settles down to $1 - \delta$, which is positive but less than one.

Example Suppose that the production function is Cobb-Douglas, so that the central equation of the Solow model is given by (5.28). The expression for the slope of the central equation is:

$$\frac{dk_{t+1}}{dk_t} = \alpha s A k_t^{\alpha-1} + (1 - \delta). \quad (5.37)$$

This can equivalently be written:

$$\frac{dk_{t+1}}{dk_t} = \alpha s A \left(\frac{1}{k_t} \right)^{1-\alpha} + (1 - \delta). \quad (5.38)$$

If $k_t = 0$, then $\frac{1}{k_t} \rightarrow \infty$. Since $1 - \alpha > 0$, and infinity raised to any positive number is infinity, the slope is infinity. Likewise, if $k_t \rightarrow \infty$, then $\frac{1}{k_t} \rightarrow 0$. 0 raised to any positive power is 0. Hence, the Inada conditions hold for the Cobb-Douglas production function.

Figure 5.1 plots k_{t+1} as a function of k_t . The plot starts in the origin, starts out steep, and flattens out as k_t gets bigger, eventually having a slope equal to $1 - \delta$. We add to this plot what is called a 45 degree line – this is a line which plots all points where the horizontal and vertical axes variables are the same, i.e. $k_{t+1} = k_t$. It therefore has a slope of 1. Since it splits the plane in half, it is often called a 45 degree line. The 45 degree line and the plot of k_{t+1} both start at the origin. The k_{t+1} plot starts out with a slope greater than 1, and hence initially lies above the 45 degree line. Eventually, the plot of k_{t+1} has a slope less than 1, and therefore lies below the 45 degree line. Since it is a continuous curve, this means that the plot of k_{t+1} cross the 45 degree line exactly once away from the origin. We indicate this point with k^* – this is the value of k_t for which k_{t+1} will be the same as k_t , i.e. $k_{t+1} = k_t = k^*$. We will refer to this point, k^* , as the “steady state.”

Figure 5.1: Plot of Central Equation of Solow Model

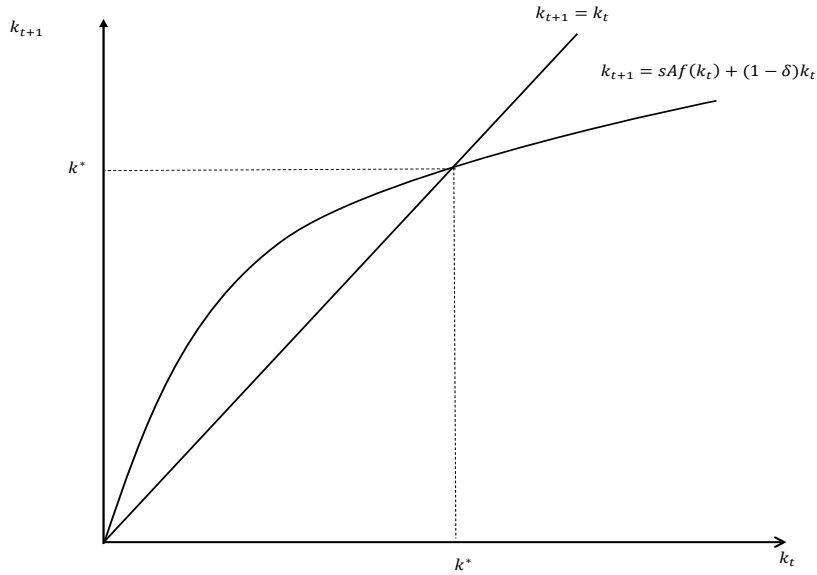

It is useful to include the 45 degree line in the plot of k_{t+1} against k_t because this makes it straightforward to use the graph to analyze the dynamics of the capital stock per worker. The 45 degree line allows one to “reflect” the horizontal axis onto the vertical axis. Suppose that the economy begins with a period t capital stock below the steady state, i.e. $k_t < k^*$. One can read the current capital stock off of the vertical axis by reflecting it with the 45 degree line. This is labeled as “initial point in period t ” in Figure 5.2. The next period capital stock, k_{t+1} , is determined at the initial k_t from the curve. Since the curve lies above the 45 degree line in this region, we see that $k_{t+1} > k_t$. To then think about how the capital stock will evolve in future periods, we can functionally iterate the graph forward another period. Use the 45 degree to reflect the new value of k_{t+1} down onto the horizontal axis. This becomes the initial capital stock in period $t + 1$. We can determine the capital stock per worker in period $t + 2$ by reading that point off of the curve at this new k_{t+1} (labeled as “initial point in period $t + 1$ ” in the graph). We can continue iterating with this procedure as we move “forward” in time. We observe that if k_t starts below k^* , then the capital stock will be expected to grow.

Figure 5.2: Convergence to Steady State from $k_t < k^*$

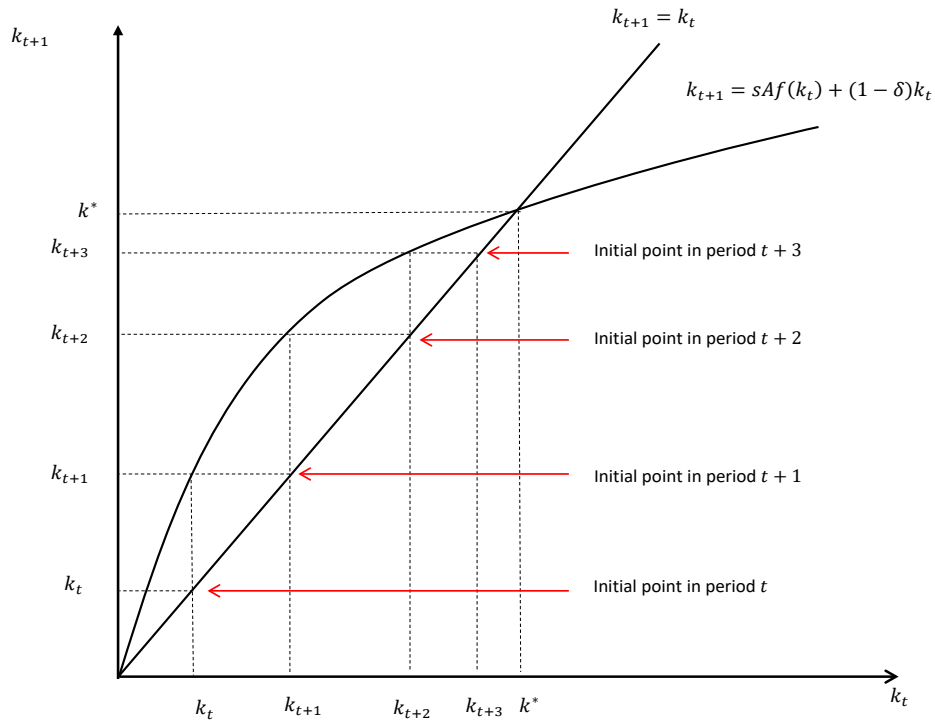
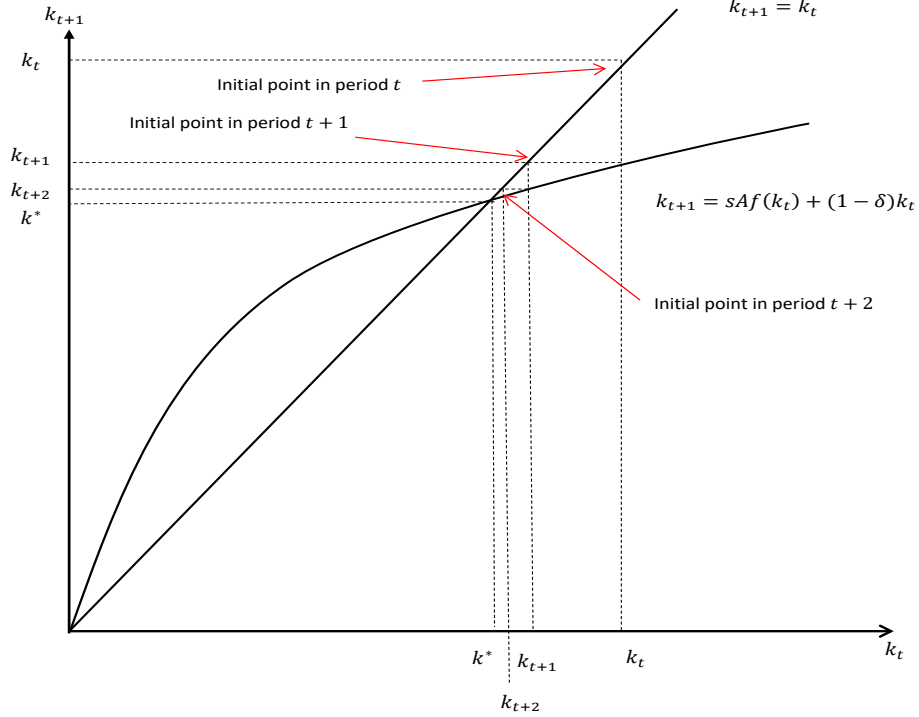

Figure 5.3 repeats the analysis but assumes the initial capital stock per worker lies above the steady state, $k_t > k^*$. The process plays out similar, but in reverse. Since in this region the line lies above the curve, the capital stock per worker will get smaller over time, eventually approaching the steady state point.

Figure 5.3: Convergence to Steady State from $k_t > k^*$



The analysis displayed in Figures 5.2 and 5.3 reveals a crucial point. For any non-zero starting value of k_t , the capital stock per worker ought to move toward k^* over time. In other words, the steady state capital stock per work is, in a sense, a point of attraction – starting from any initial point, the dynamics embedded in the model will continuously move the economy toward that point. Once the economy reaches $k_t = k^*$, it will stay there (since $k_{t+1} = k_t$ at that point), hence the term “steady.” Furthermore, the capital stock will change quite a bit across time far from the steady state (i.e. at these points the vertical gap between the curve and the line is large) and will change very little when the initial capital stock is close to the steady state (the curve is close to the line in this region). Figure 5.4 plots hypothetical time paths of the capital stock, where in one case $k_t > k^*$ and in the other $k_t < k^*$. In the former case, k_t declines over time, approaching k^* . In the latter, k_t increases over time, also approaching k^* .

Figure 5.4: Convergence to Steady State

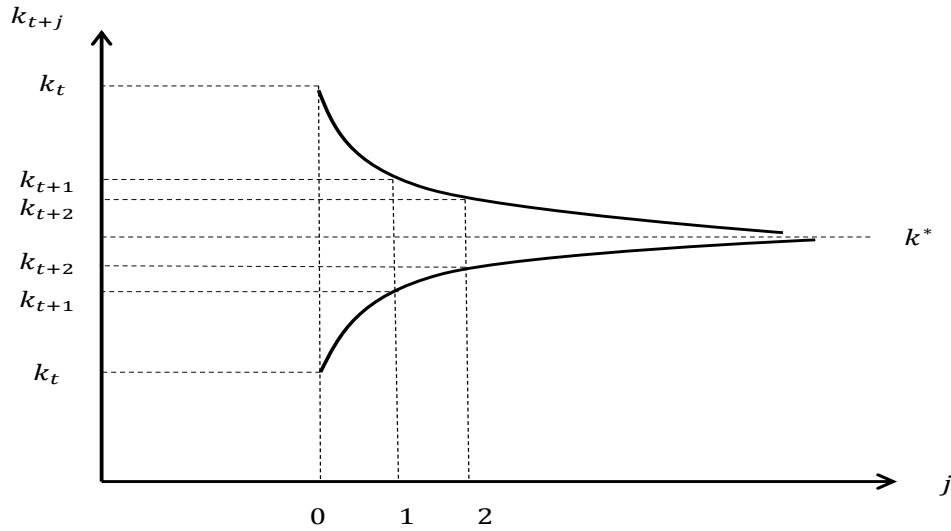

The steady state is a natural point of interest. This is not because the economy is always at the steady state, but rather because, no matter where the economy starts (provided it does not start with $k_t = 0$), it will naturally gravitate towards this point.

An alternative way to graphically analyze the Solow model, one that is commonly presented in textbooks, is to transform the central equation of the Solow model, (5.19), into first differences. In particular, define $\Delta k_{t+1} = k_{t+1} - k_t$. Subtracting k_t from both sides of (5.19), one gets:

$$\Delta k_{t+1} = sAf(k_t) - \delta k_t. \quad (5.39)$$

In (5.39), the first term on the right hand side, $sAf(k_t)$, is total investment. The second term, δk_t , is total depreciation. This equation says that the change in the capital stock is equal to the difference between investment and depreciation. Sometimes the term δk_t is called “break-even investment,” because this is the amount of investment the economy must do so as to keep the capital stock from falling.

Figure 5.5: Alternative Plot of Central Equation of Solow Model

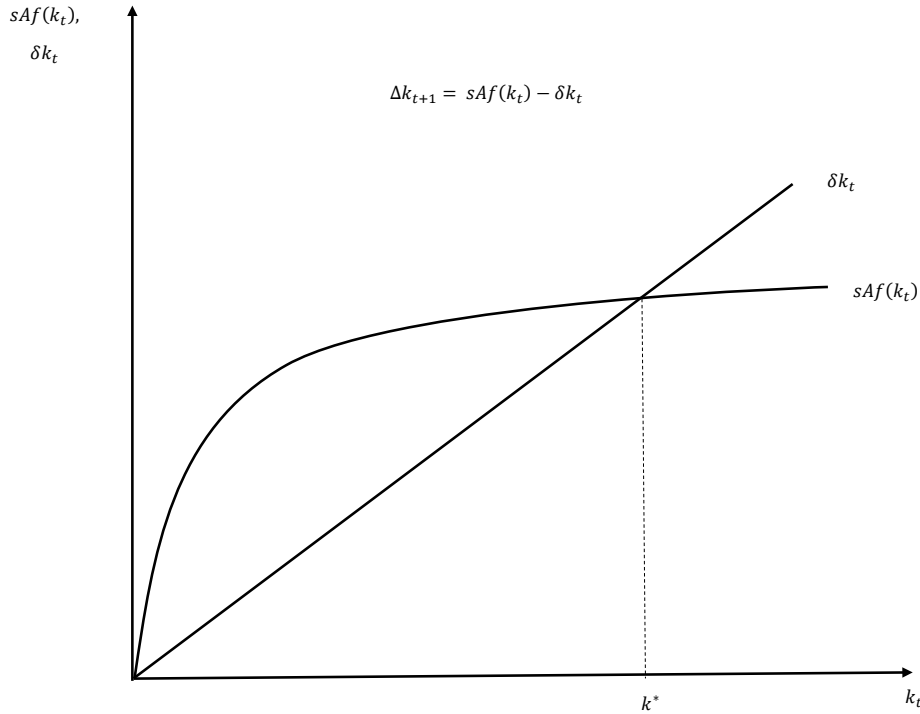

Figure 5.5 plots the two different terms on the right hand side of (5.39) against the initial capital stock per worker, k_t . The first term, $sAf(k_t)$, starts at the origin, is increasing (since $f'(k_t) > 0$), but has diminishing slope (since $f''(k_t) < 0$). Eventually, as k_t gets big enough, the slope of this term goes to zero. The second term is just a line with slope δ , which is positive but less than one. The curve must cross the line at some value of k_t , call it k^* . This single crossing is guaranteed if the Inada conditions hold, which we assume they do. This is the same steady state capital stock derived using the alternative graphical depiction. For values of $k_t < k^*$, we have the curve lying above the line, which means that investment, $sAf(k_t)$, exceeds depreciation, δk_t , so that the capital stock will be expected to grow over time. Alternatively, if $k_t > k^*$, then depreciation exceeds investment, and the capital stock will decline over time.

We prefer the graphical depiction shown in Figure 5.1 because we think it is easier to use the graph to think about the dynamics of capital per worker across time. That said, either graphical depiction is correct, and both can be used to analyze the effects of changes in exogenous variables or parameters.

5.3 The Algebra of the Steady State with Cobb-Douglas Production

Suppose that the production function is Cobb-Douglas, so that the central equation of the model is given by (5.28) and the other variables are determined by (5.29). To algebraically solve for the steady state capital stock, take (5.28) and set $k_{t+1} = k_t = k^*$:

$$k^* = sAk^{*\alpha} + (1 - \delta)k^*.$$

This is one equation in one unknown. k^* is:

$$k^* = \left(\frac{sA}{\delta} \right)^{\frac{1}{1-\alpha}}. \quad (5.40)$$

We observe that k^* is increasing in s and A and decreasing in δ . All the other variables in the model can be written as functions of k_t and parameters. Hence, there will exist a steady state in these other variables as well. Plugging (5.40) in wherever k_t shows up, we get:

$$y^* = Ak^{*\alpha} \quad (5.41)$$

$$c^* = (1 - s)Ak^{*\alpha} \quad (5.42)$$

$$i^* = sAk^{*\alpha} \quad (5.43)$$

$$R^* = \alpha Ak^{*\alpha-1} \quad (5.44)$$

$$w^* = (1 - \alpha)Ak^{*\alpha}. \quad (5.45)$$

5.4 Experiments: Changes in s and A

We want to examine how the variables in the Solow model react dynamically to changes in parameters and exogenous variables. Consider first an increase in s . This parameter is exogenous to the model. In the real world, increases in the saving rate could be driven by policy changes (e.g. changes to tax rates which encourage saving), demographics (e.g. a larger fraction of the population is in its prime saving years), or simply just preferences (e.g. households are more keen on saving for the future). Suppose that the economy initial sits in a steady state, where the saving rate is s_0 . Then, in period t , the saving rate increases to $s_1 > s_0$ and is forever expected to remain at s_1 .

In terms of the graph, an increase in s has the effect of shifting the curve plotting k_{t+1} against k_t up. It is a bit more nuanced than simply a shift up, as an increase in s also has the effect of making the curve steeper at every value of k_t . This effect can be seen in Figure

5.6 below with the blue curve. The 45 degree line is unaffected. This means that the curve intersects the 45 degree line at a larger value, $k_1^* > k_0^*$. In other words, a higher value of the saving rate results in a larger steady state capital stock. This can be seen mathematically in (5.40) for the case of a Cobb-Douglas production function.

Figure 5.6: Exogenous Increase in s , $s_1 > s_0$

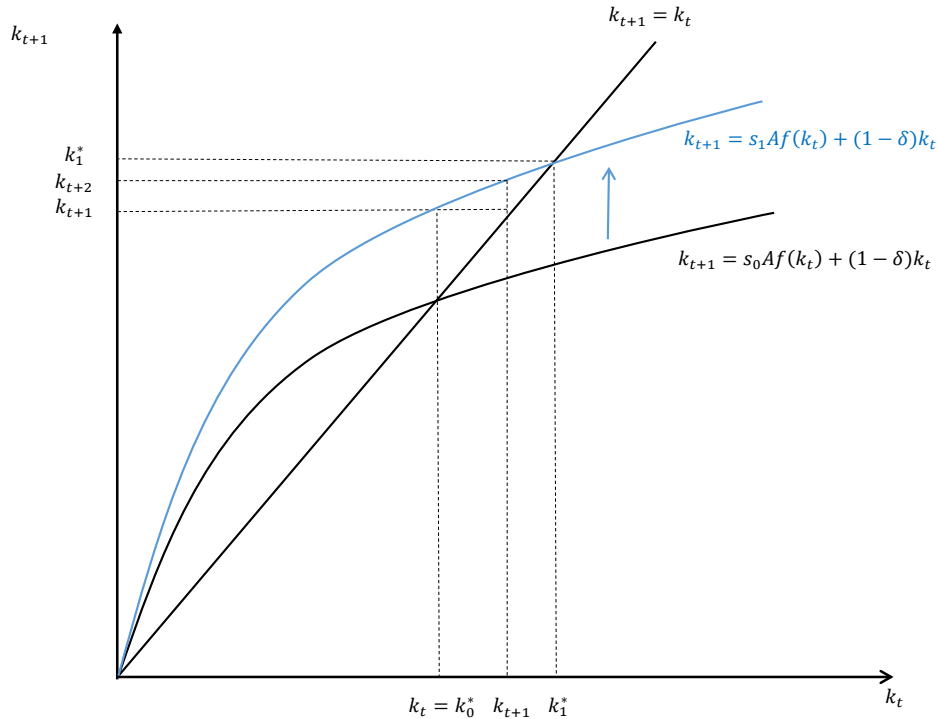

Now, let's use the graph to think about the process by which k_t transitions to the new, higher steady state. The period t capital stock cannot jump – it is predetermined and hence exogenous within period. We can determine the $t + 1$ value by reading off the new, blue curve at the initial k_t . We see that $k_{t+1} > k_t$, so the capital stock per worker will grow after an increase in the saving rate. From that point on, we continue to follow the dynamics we discussed above in reference to Figure 5.2. In other words, when s increases, the economy is suddenly below its steady state. Hence, the capital stock will grow over time, eventually approaching the new, higher steady state.

Figure 5.7: Dynamic Responses to Increase in s

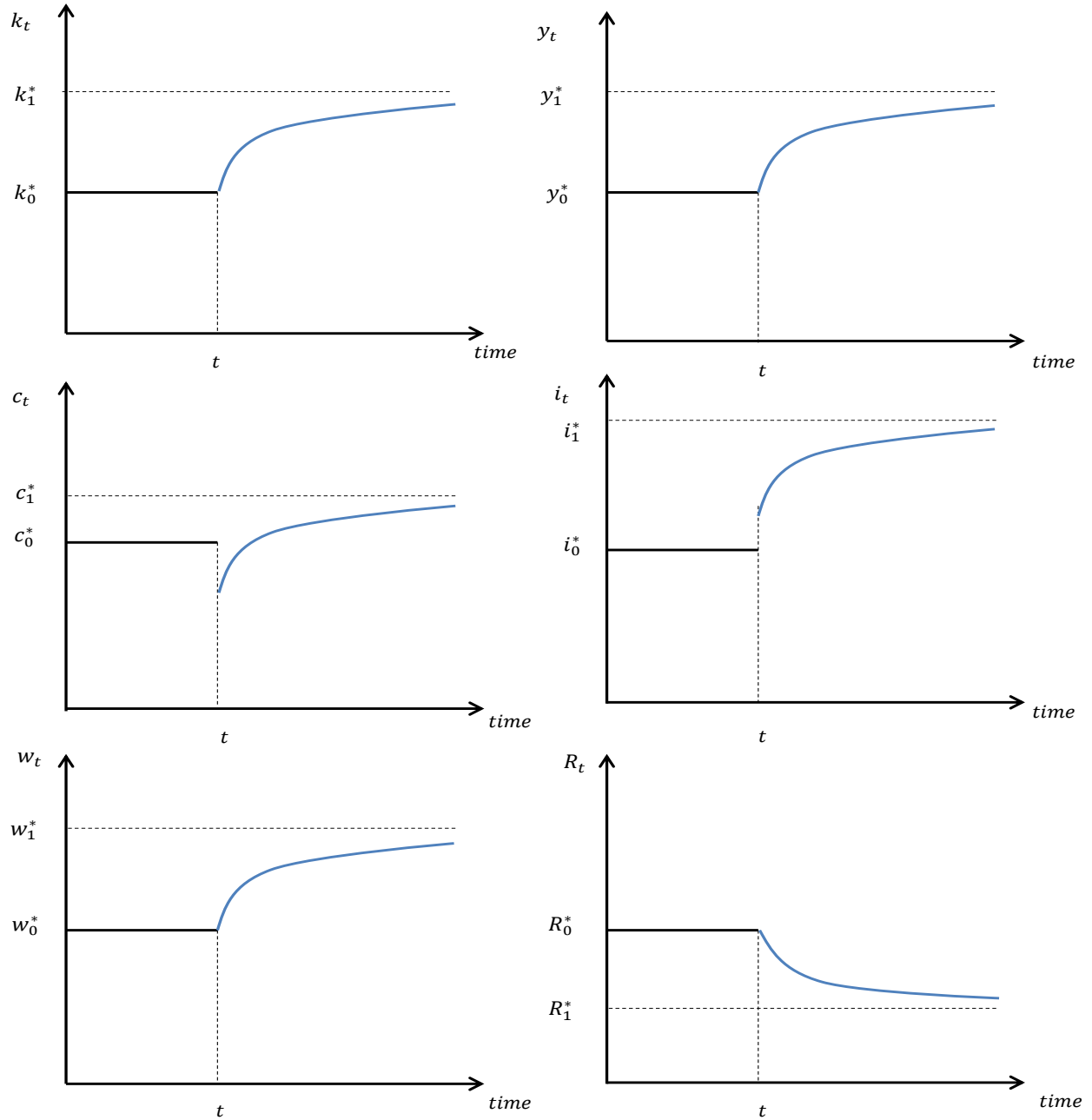

We can trace out the dynamic path of the capital stock per worker to an increase in s , which is shown in the upper left panel of Figure 5.7. Prior to period t , assume that the economy sits in a steady state associated with the saving rate s_0 . In period t (the period in which s increases), nothing happens to the capital stock per worker. It starts getting bigger in period $t + 1$ and continues to get bigger, though at a slower rate as time passes. Eventually, it will approach the new steady state associated with the higher saving rate, k_1^* .

Once we have the dynamic path of k_t , we can back out the dynamic paths of all other

variables in the model. Since $y_t = Af(k_t)$, output will follow a similar looking path to k_t – it will not change in period t , and then will grow for a while, approaching a new, higher steady state value. Note that the response graphs in Figure 5.7 are meant to be qualitative and are not drawn to scale, so do not interpret anything about the magnitudes of the responses of k_t and other variables. Since $c_t = (1 - s)y_t$, consumption per worker must initially *decline* in the period in which the saving rate increases. Effectively, the “size of the pie,” y_t , doesn’t initially change, but a smaller part of the pie is being consumed. After the initial decrease, consumption will begin to increase, tracking the paths of k_t and y_t . Whether consumption ends up in a higher or lower steady state than where it began is unclear, though we have drawn the figure where consumption eventually ends up being higher. Investment is $i_t = sy_t$. Hence, investment per worker must jump up in the period in which the saving rate increases. It will thereafter continue to increase as capital accumulates and transitions to the new steady state. w_t will not react in period t , but will follow a similar dynamic path as the other variables thereafter. This happens because of our underlying assumption that $F_{NK} > 0$ – so having more capital raises the marginal product of labor, and hence the wage. The rental rate on capital, R_t , will not react in the period s increases but then will decrease thereafter. This is driven by the assumption that $F_{KK} < 0$. As capital accumulates following the increase in the saving rate, the marginal product of capital falls. It will continue to fall and eventually ends up in a lower steady state.

What happens to the *growth rate* of output after an increase in s ? Using the approximation that the growth rate is approximately the log first difference of a variable, define $g_t^y = \ln y_t - \ln y_{t-1}$ as the growth rate of output. Since output per worker converges to a steady state, in steady state output growth is 0. In the period of the increase in s , nothing happens to output, so nothing happens to output growth. Since output begins to increase starting in period $t + 1$, output growth will jump up to some positive value in period $t + 1$. It will then immediately begin to decrease (though remain positive), as we transition to the new steady state, in which output growth is again zero. This is displayed graphically in Figure 5.8.

Figure 5.8: Dynamic Path of Output Growth

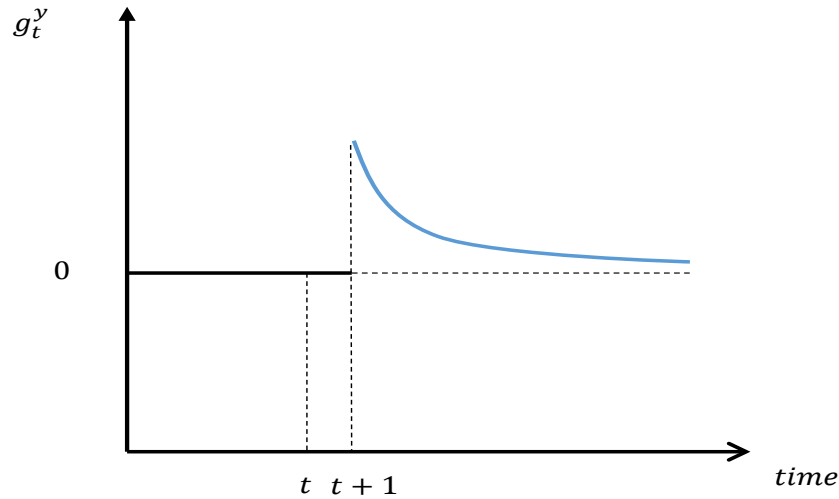

The analysis portrayed graphically in Figure 5.8 has an important and powerful implication – output will *not* forever grow faster if an economy increases the saving rate. There will be an initial burst of higher than normal growth immediately after the increase in s , but this will dissipate and the economy will eventually return to a steady state no growth.

Next, consider the experiment of an exogenous increase in A . In particular, suppose that, prior to period t , the economy sits in a steady state associated with A_0 . Then, suppose that A increases to A_1 . This change is permanent, so all future values of A will equal A_1 . How will this impact the economy? In terms of the main graph plotting k_{t+1} against k_t , this has very similar effects to an increase in s . For every value of k_t , k_{t+1} will be higher when A is higher. In other words, the curve shifts up (and has a steeper slope at every value of k_t). This is shown in Figure 5.9 below.

We can use the figure to think about the dynamic effects on k_t . Since the curve is shifted up relative to where it was with $A_{0,t}$, we know that the curve will intersect the 45 degree line at a higher value, meaning that the steady state capital stock will be higher, $k_1^* > k_0^*$. In period t , nothing happens to k_t . But since the curve is now shifted up, we will have $k_{t+1} > k_t$. Capital will continue to grow as it transitions toward the new, higher steady state.

Figure 5.9: Exogenous Increase in A , $A_1 > A_0$

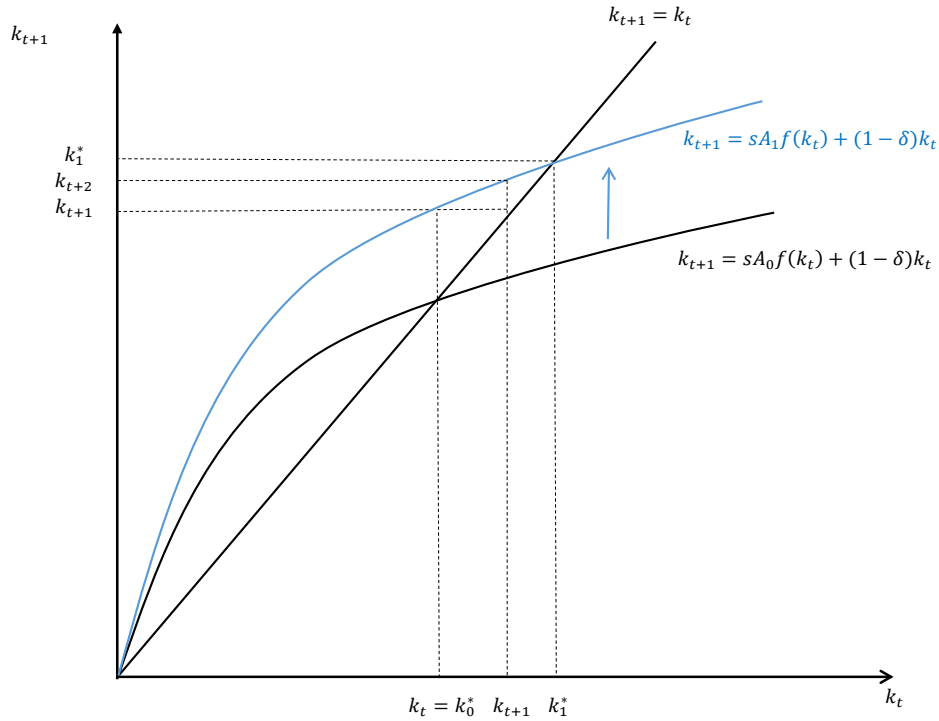

Given a permanent higher value of A , once we know the dynamic path of k_t we can determine the dynamic paths of the other variables just as we did in the case with an increase in s . These are shown in Figure 5.10. The capital stock per worker does not jump in period t , but grows steadily thereafter, eventually approaching a new higher steady state. Next, consider what happens to y_t . Since $y_t = Af(k_t)$, y_t jumps up initially in period t (unlike the case of an increase in s). This increase in period t is, if you like, the “direct effect” of the increase in A on y_t . But y_t continues to grow thereafter, due to the accumulation of more capital. It eventually levels off to a new higher steady state. c_t and i_t follow similar paths as y_t , since they are just fixed fractions of output. The wage also follows a similar path – it jumps up initially, and then continues to grow as capital accumulates. The rental rate on capital, R_t , initially jumps up. This is because higher A makes the marginal product of capital higher. But as capital accumulates, the marginal product of capital starts to decline. Given the assumptions we have made on the production function, one can show that R_t eventually settles back to where it began – there is no effect of A on the steady state value of R_t .

Figure 5.10: Dynamic Responses to Increase in A

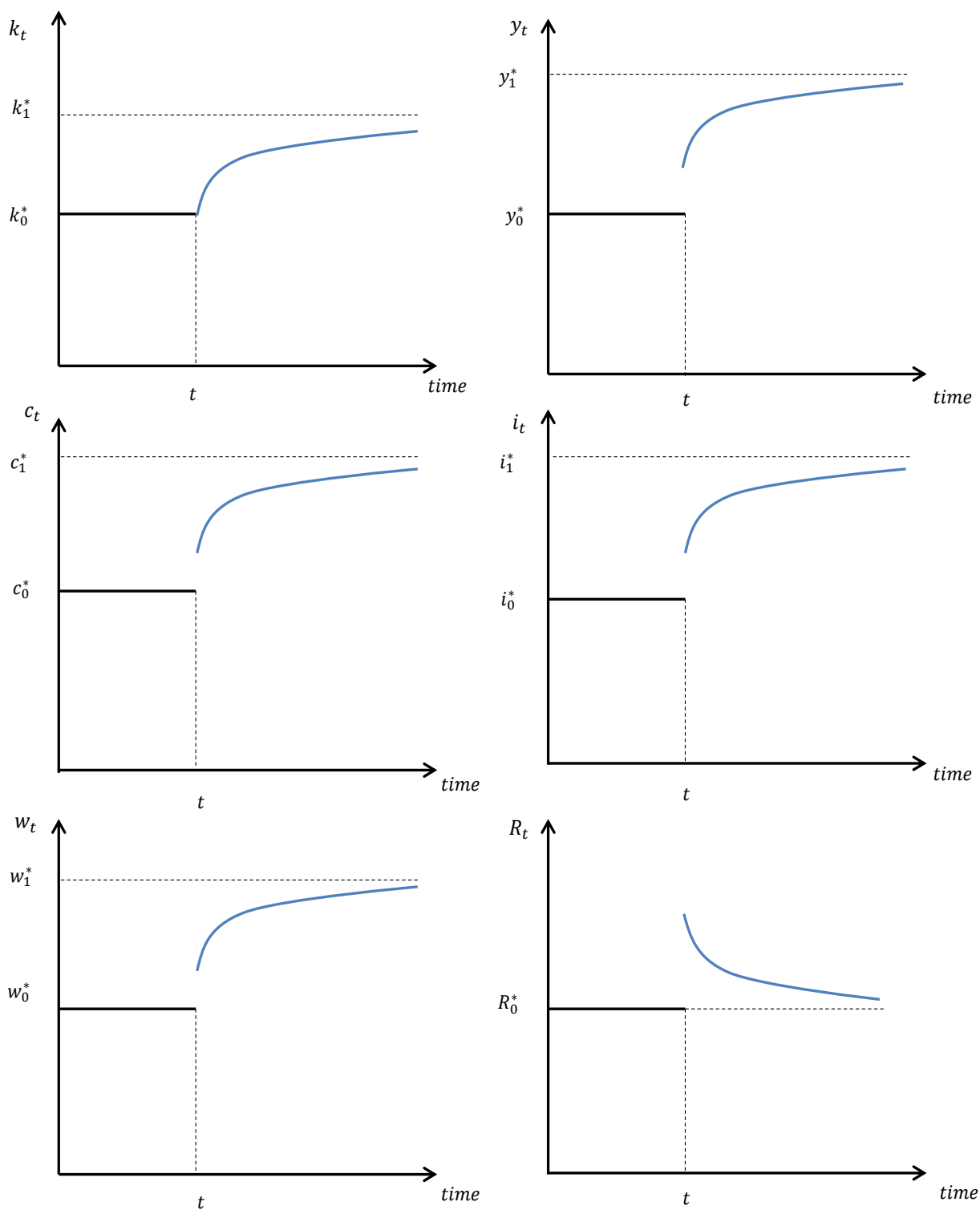

Mathematical Diversion

How does one know that there is no long run effect of A on R_t ? Suppose that the

production function is Cobb-Douglas. Then the expression for steady state R^* is:

$$R^* = \alpha A k^{*\alpha-1}. \quad (5.46)$$

Plug in the steady state expression for k^* :

$$R^* = \alpha A \left(\frac{sA}{\delta} \right)^{\frac{\alpha-1}{1-\alpha}}. \quad (5.47)$$

The exponent here is -1 , which means we can flip numerator and denominator. In other words, the A cancel out, leaving:

$$R^* = \frac{\alpha\delta}{s}. \quad (5.48)$$

As mentioned above, we can think about there being two effects of an increase in A on the variables of the model. There is the direct effect, which is what happens holding k_t fixed. Then there is an indirect effect that comes about because higher A triggers more capital accumulation. This indirect effect is qualitatively the same as what happens when s changes. What differs across the two cases is that the increase in A causes an immediate effect on the variables in the model.

Figure 5.11: Dynamic Path of Output Growth

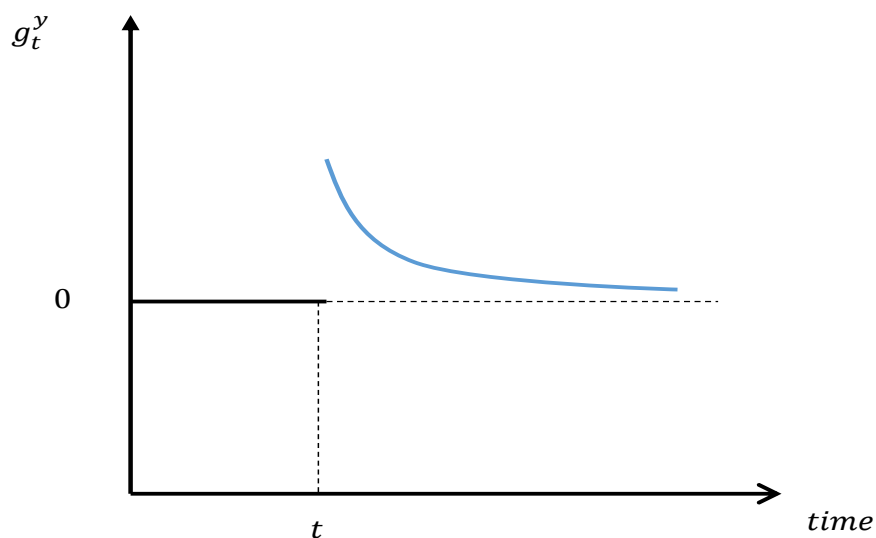

As we did for the case of an increase in s , we can think about what happens to the growth rate of output following a permanent increase in A . This is shown in Figure 5.11. Qualitatively, it looks similar to Figure 5.8, but the subtle difference is that output growth jumps up *immediately* in period t , whereas in the case of an increase in s there is no increase

in output growth until period $t + 1$. In either case, the extra growth eventually dissipates, with output growth ending back up at zero.

At this point, it is perhaps useful to pause for a moment and foreshadow some of what we will do in the next chapter. We sat out to study economic growth, but then wrote down a model in which the economy naturally converges to a steady state in which there is *no growth*. Is the Solow model therefore ill-suited to study sustained growth over long periods of time, of the type documented in Chapter 4? We think not. As we will show in Chapter 6, the model can be tweaked in such a way that there is steady state growth. But the basic model presented in this chapter gives us the insight of where that steady state growth must come from. Sustained growth *cannot* come from capital accumulation per se. As shown above, an increase in s triggers temporarily high growth because of capital accumulation, but this dissipates and eventually growth settles back down to zero. Even if an economy repeatedly increased its saving rate, it would eventually run out of room to do so (as s is bound from above by 1), so even repeated increases in s cannot plausibly generate sustained growth over long periods of time. What about changes in A ? It is true that a one time change in A only generates a temporary burst of output growth which is magnified due to capital accumulation as the economy transitions to a new steady state. But unlike changes in s , there is no logical limit on productivity repeatedly increasing over time. This means that continual productivity improvements could plausibly generate sustained growth in output per capita over time.

5.5 The Golden Rule

As discussed in reference to Figure 5.7, there is an ambiguous effect of an increase in the saving rate on the steady state level of consumption per worker. Increasing the saving rate always results in an increase in k^* , and hence an increase in y^* . In other words, a higher saving rate always results in a bigger “size of the pie.” But increasing the saving rate means that households are consuming a smaller fraction of the pie. Which of these effects dominates is unclear.

We can see these different effects at work in the expression for the steady state consumption per worker:

$$c^* = (1 - s)Af(k^*). \quad (5.49)$$

A higher s increases $f(k^*)$ (since a higher s increases k^*), but reduces $1 - s$. We can see that if $s = 0$, then $c^* = 0$. This is because if $s = 0$, then $k^* = 0$, so there is nothing at all available to consume. Conversely, if $s = 1$, then we can also see that $c^* = 0$. While $f(k^*)$ may be big if $s = 1$, there is nothing left for households to consume. We can therefore intuit that c^* must be increasing in s when s is near 0, and decreasing in s when s is near 1. A

hypothetical plot of c^* and against s is shown below:

Figure 5.12: s and c^* : The Golden Rule

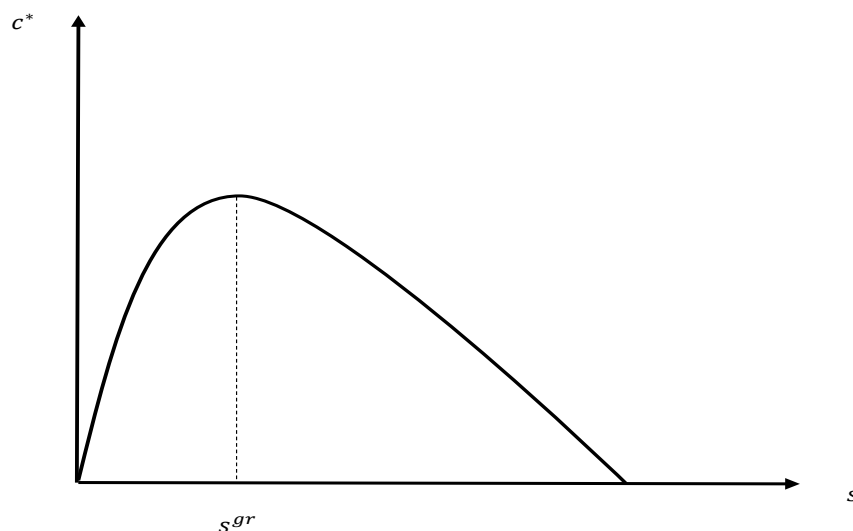

We can characterize the golden rule mathematically via the following condition:

$$Af'(k^*) = \delta. \quad (5.50)$$

The derivation for (5.50) is given below. What this says, in words, is that the saving rate must be such that the marginal product of capital equals the depreciation rate on capital. This expression only implicitly defines s in that k^* is a function of s ; put differently, the Golden Rule s (denoted by s^{gr}), must be such that k^* is such that (5.50) holds.

Mathematical Diversion

We can derive an expression that must hold at the Golden Rule using the total derivative (also some times called implicit differentiation). The steady state capital stock is implicitly defined by:

$$sAf(k^*) = \delta k^*. \quad (5.51)$$

Totally differentiate this expression about the steady state, allowing s to vary:

$$sAf'(k^*)dk^* + Af(k^*)ds = \delta dk^*. \quad (5.52)$$

Solve for dk^* :

$$[sAf'(k^*) - \delta]dk^* = -Af(k^*)ds. \quad (5.53)$$

Steady state consumption is implicitly defined by:

$$c^* = Af(k^*) - sAf(k^*). \quad (5.54)$$

Totally differentiate this expression:

$$dc^* = Af'(k^*)dk^* - sAf'(k^*)dk^* - Af(k^*)ds. \quad (5.55)$$

Re-arranging terms:

$$dc^* = [Af'(k^*) - sAf'(k^*)] dk^* - Af(k^*)ds. \quad (5.56)$$

From (5.53), we know that $-Af(k^*)ds = [sAf'(k^*) - \delta] dk^*$. Plug this into (5.56) and simplify:

$$dc^* = [Af'(k^*) - \delta] dk^*. \quad (5.57)$$

Divide both sides of (5.57) by ds :

$$\frac{dc^*}{ds} = [Af'(k^*) - \delta] \frac{dk^*}{ds}. \quad (5.58)$$

For s to maximize c^* , it must be the case that $\frac{dc^*}{ds} = 0$. Since $\frac{dk^*}{ds} > 0$, this can only be the case if:

$$Af'(k^*) = \delta. \quad (5.59)$$

Figure 5.13 below graphically gives a sense of why (5.50) must hold. It plots $y_t = Af(k_t)$, $i_t = sAf(k_t)$, and δk_t against k_t . For a given k_t , the vertical distance between y_t and i_t is c_t , consumption. At the steady state, we must have $sAf(k^*) = \delta k^*$; in other words, the steady state is where the plot of i_t crosses the plot of δk_t . Steady state consumption is given by the vertical distance between the plot of y_t and the plot of i_t at this k^* . The Golden rule saving rate is the s that maximizes this vertical distance. Graphically, this must be where the plot of $y_t = Af(k_t)$ is tangent to the plot of δk_t (where $sAf(k_t)$ crosses in the steady state). To be tangent, the slopes must equal at that point, so we must have $Af'(k_t) = \delta$ at the Golden rule. In other words, at the Golden Rule, the marginal product of capital equals the depreciation rate on capital.

Figure 5.13: The Golden Rule Saving Rate

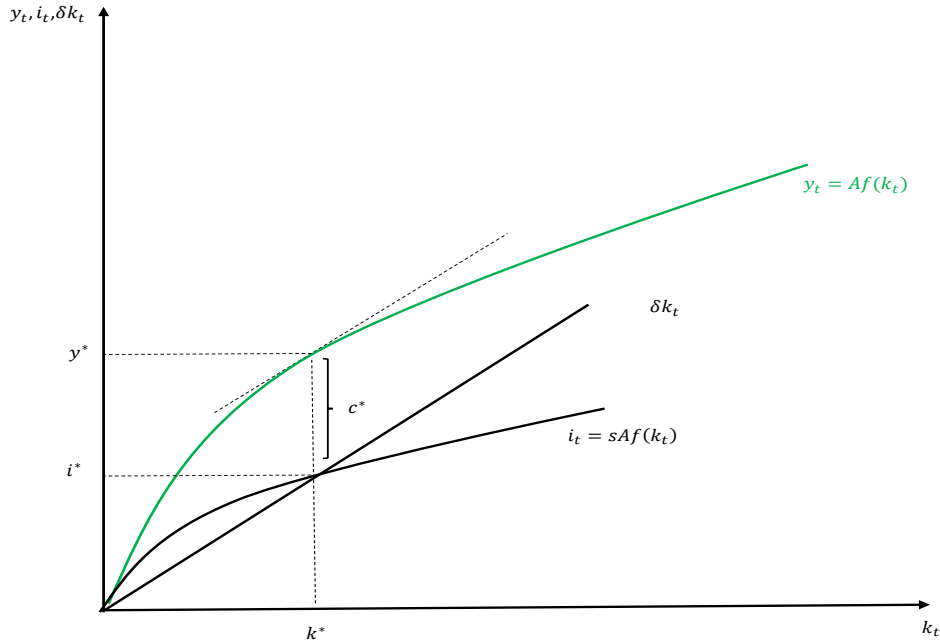

What is the intuition for this implicit condition characterizing the Golden rule saving rate? Suppose that, for a given s , that $Af'(k^*) > \delta$. This means that raising the steady state capital stock (by increasing s) raises output by more than it raises steady state investment (the change in output is the marginal product of capital, $Af'(k^*)$, and the change in steady state investment is δ). This means that consumption increases, so this s cannot be the s which maximizes steady state consumption. In contrast, if s is such that $Af'(k^*) < \delta$, then the increase in output from increasing the steady state capital stock is smaller than the increase in steady state investment, so consumption declines. Hence that s cannot be the s which maximizes steady state consumption. Only if $Af'(k^*) = \delta$ is s consistent with steady state consumption being as big as possible.

Let us now think about the dynamic effects of an increase in s , depending on whether the saving rate is initially above or below the Golden Rule. The important insight here is that the Golden Rule only refers to what the effect of s is on steady state consumption. An increase in s always results in an immediate reduction in c_t in the short run – a larger fraction of an unchanged level of income is being saved. After the initial short run decline, c_t starts to increase as the capital stock increases and hence income increases. Whether the economy ends up with more or less consumption in the long run depends on where s was initially relative to the Golden Rule. If initially $s < s^{gr}$, then a small increase in s results in a long run increase in consumption in the new steady state. If $s > s^{gr}$, then an increase in s

results in a long run decrease in consumption in the new steady state. These features can be seen in Figure 5.14, which plots out hypothetical time paths of consumption. Prior to t , the economy sits in a steady state. Then, in period t , there is an increase in s . Qualitatively, the time path of c_t looks the same whether we are initially above or below the Golden Rule. What differs is whether c_t ends up higher or lower than where it began.

Figure 5.14: Effects of $\uparrow s$ Above and Below the Golden Rule

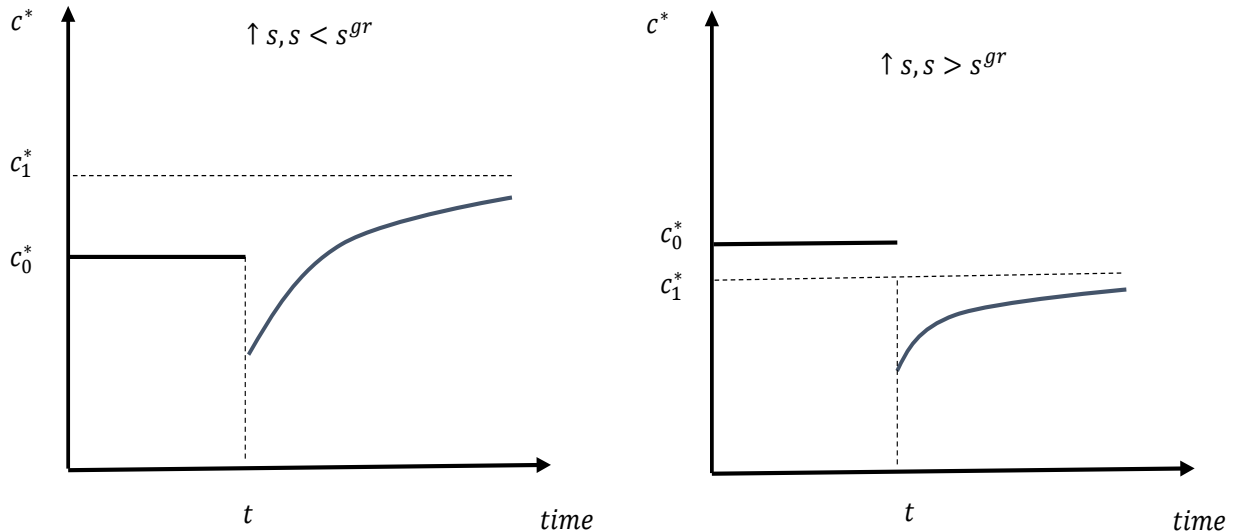

We can use these figures to think about whether it is desirable to increase s or not. One is tempted to say that if $s < s^{gr}$, then it is a good thing to increase s . This is because a higher s results in more consumption in the long run, which presumably makes people better off. This is not necessarily the case. The reason is that the higher long run consumption is only achieved through lower consumption in the short run – in other words, there is some short run pain in exchange for long run gain. Whether people in the economy would prefer to endure this short run pain for the long run gain is unclear; it depends on how impatient they are. If people are very impatient, the short run pain might outweigh the long run gain. Moreover, if the dynamics are sufficiently slow, those who sacrificed by consuming less in the present may be dead by the time the average level of consumption increases. In that case, people would decide to save more only if they received utility from knowing future generations would be better off. Without saying something more specific about how people discount the future (i.e. how impatient they are) or how they value the well-being of future generations, it is not possible to draw normative conclusions about whether or not the saving rate should increase.

What about the case where $s > s^{gr}$. Here, we can make a more definitive statement. In particular, households would be unambiguously better off by *reducing* s . A reduction in

s would result in more consumption immediately, and higher consumption (relative to the *status quo*) at *every* subsequent date, including the new steady state. Regardless of how impatient people are, a reduction in s gives people more consumption at every date, and hence clearly makes them better off. We say that an economy with $s > s^g$ is “dynamically inefficient.” It is inefficient in that consumption is being “left on the table” because the economy is saving too much; it is dynamic because consumption is being left on the table both in the present and in the future.

5.6 Summary

- The production function combines capital and labor into output. It is assumed that both inputs are necessary for production, that the marginal products of both inputs are positive but diminishing, and that the production function exhibits constant returns to scale.
- Capital is a factor of production which must itself be produced, which helps produce output, and which is not completely used up in the production process. Investment is expenditure on new physical capital which becomes productive in the future.
- The Solow model assumes that the household (or households) obey simple rules of thumb which are not necessarily derived from optimizing behavior. The household consumes a constant fraction of its income (and therefore saves/invests a constant fraction of its income) and supplies labor inelastically.
- Given these assumptions, the Solow model can be summarized by one central equation that characterizes the evolution of the capital stock per worker.
- Starting with any initial level of capital per worker greater than zero, the capital stock converges to a unique steady state.
- An increase in the saving rate or the productivity level results in temporarily higher, but not permanently higher, output growth.
- The golden rule is the saving rate that maximizes long run consumption per capita. If the saving rate is less than the golden rule saving rate, consumption must be lower in the short term in order to be higher in the long run. If the saving rate is higher than the golden rule, consumption can increase at every point in time.

Key Terms

- Capital
- Constant returns to scale
- Saving rate
- Inada conditions
- Steady state
- Golden rule

Questions for Review

1. We have assumed that the production function simultaneously has constant returns to scale and diminishing marginal products. What do each of these terms mean? Is it a contradiction for a production function to feature constant returns to scale and diminishing marginal products? Why or why not?
2. What are the Inada conditions? Explain how the Inada conditions, along with the assumption of a diminishing marginal product of capital, ensure that a steady state capital stock exists.
3. Graph the central equation of the Solow model. Argue that a steady state exists and that the economy will converge to this point from any initial starting capital stock.
4. What is the Golden Rule saving rate? Is it different than the saving rate which maximizes present consumption?
5. What would be the saving rate which would maximize steady state output? Would the household like that saving rate? Why or why not?
6. In words, explain how one can say that a household is definitely better off from reducing the save rate if it is initially above the Golden Rule, but cannot say whether or not a household is better or worse if it increases the saving rate from below the Golden Rule.
7. Critically evaluate the following statement: “Because a higher level of A does not lead to permanently high growth rates, higher levels of A are not preferred to lower levels of A .”

Exercises

1. Suppose that the production function is the following:

$$Y_t = A \left[\alpha K_t^{\frac{\nu-1}{\nu}} + (1 - \alpha) N_t^{\frac{\nu-1}{\nu}} \right]^{\frac{\nu}{\nu-1}}.$$

It is assumed that the parameter $\nu \geq 0$ and $0 < \alpha < 1$.

- (a) Prove that this production function features constant returns to scale.
 - (b) Compute the first partial derivatives with respect to K_t and N_t . Argue that these are positive.
 - (c) Compute the own second partial derivatives with respect to K_t and N_t . Show that these are both negative.
 - (d) As $\nu \rightarrow 1$, how do the first and second partial derivatives for this production function compare with the Cobb-Douglas production discussed in the text?
2. Suppose that you have a standard Solow model. The central equation governing the dynamics of the *level* of capital is given by (5.18). In terms of capital *per worker*, the central equation is given by (5.19). The production function has the normal properties.
- (a) Suppose that the economy initially sits in a steady state in terms of the capital stock per worker, k_t . Suppose that, at time t , the number of workers doubles (say, due to an influx of immigrants). The number of workers is expected to remain forever thereafter constant at this new higher level, i.e. $N_{t+1} = N_t$. Graphically analyze how this will impact the steady state capital stock per worker and the dynamics starting from an initial capital stock.
 - (b) Draw diagrams plotting out how capital, output, and the real wage ought to respond dynamically to the permanent increase in the workforce.
3. Suppose that we have a Solow model with one twist. The twist is that there is a government. Each period, the government consumes a fraction of output, s_G . Hence, the aggregate resource constraint is:

$$Y_t = C_t + I_t + G_t.$$

Where $G_t = s_G Y_t$. Define private output as $Y_t^p = Y_t - G_t$. Suppose that investment is a constant fraction, s , of private output (consumption is then $1 - s$ times private output). Otherwise the model is the same as in the text.

- (a) Re-derive the central equation of the Solow model under this setup.
 - (b) Suppose that the economy initially sits in a steady state. Suppose that there is an increase in s_G that is expected to last forever. Graphically analyze how this will affect the steady state value of the capital stock per worker. Plot out a graph showing how the capital stock per worker will be affected in a dynamic sense.
4. Suppose that we have a standard Solow model with a Cobb-Douglas production function. The central equation of the model is as follows:

$$k_{t+1} = sAk_t^\alpha + (1 - \delta)k_t.$$

Consumption per worker is given by:

$$c_t = (1 - s)Ak_t^\alpha.$$

- (a) Solve for an expression for the steady state capital stock per worker. In doing so, assume that the level of productivity is fixed at some value A .
 - (b) Use your answer on the previous part to solve for an expression for steady state consumption per worker.
 - (c) Use calculus to derive an expression for the s which maximizes steady state consumption per worker.
5. **Excel Problem.** Suppose that you have a standard Solow model with a Cobb-Douglas production function. The central equation of the model can be written:

$$k_{t+1} = sAk_t^\alpha + (1 - \delta)k_t.$$

Output per worker is given by:

$$y_t = Ak_t^\alpha.$$

Consumption per worker is given by:

$$c_t = (1 - s)y_t.$$

- (a) Suppose that A is constant at 1. Solve for an expression for the steady state capital per worker, steady state output per worker, and steady state consumption per worker.

- (b) Suppose that $\alpha = 1/3$ and $\delta = 0.1$. Create an Excel sheet with a grid of values of s ranging from 0.01 to 0.5, with a gap of 0.01 between entries (i.e. you should have a column of values 0.01, 0.02, 0.03, and so on). For each value of s , numerically solve for the steady state values of capital, output, and consumption per worker. Produce a graph plotting these values against the different values of s . Comment on how the steady state values of capital, output, and consumption per worker vary with s .
- (c) Approximately, what is the value of s which results in the highest steady state consumption per worker? Does this answer coincide with your analytical result on the previous question?
6. **Excel Problem.** Suppose that you have a standard Solow model with a Cobb-Douglas production function. The central equation of the model can be written:

$$k_{t+1} = sAk_t^\alpha + (1 - \delta)k_t.$$

- (a) Analytically solve for an expression for the steady state capital stock per worker.
- (b) Suppose that $A = 1$ and is fixed across time. Suppose that $s = 0.1$ and $\delta = 0.10$. Suppose that $\alpha = 1/3$. Create an Excel file. Using your answer from the previous part, numerically solve for k^* using these parameter values.
- (c) Create a column in your Excel sheet corresponding to periods. Let these periods run from period 1 to period 100. Suppose that the capital stock per worker equals its steady state in period 1. Use the central equation of the Solow model to compute the capital stock in period 2, given this capital stock in period 1. Then iterate again, computing the capital stock in period 3. Continue on up until period 9. What is true about the capital stock in periods 1 through 9 when the capital stock starts in the steady state in period 1?
- (d) Suppose that in period 10 the saving rate increases to 0.2 and is expected to forever remain there. What will happen to the capital stock in period 10?
- (e) Compute the capital stock in period 11, given the capital stock in period 10 and the new, higher saving rate. Then iterate, going to period 11, and then period 12. Fill your formula down all the way to period 100. Produce a plot of the capital stock from periods 1 to 100.

- (f) About how many periods does it take the capital stock to get halfway to its new, higher steady state value when s increases from 0.1 to 0.2?

Chapter 6

The Augmented Solow Model

We developed the basic Solow model in Chapter 5. The model is intended to study long run growth, but has the implication the economy converges to a steady state in which it does not grow. How, then, can the model be used to understand growth?

In this chapter, we augment the basic Solow model to include exogenous growth in both productivity and the population. Doing so requires transforming the variables of the model, but ultimately we arrive at a similar conclusion – the model converges to a steady state in which the transformed variables of the model are constant. As we will see, the transformed variables being constant means that several of the actual variables will nevertheless be growing. This growth comes from the assumed exogenous growth in productivity and population. The model makes predictions about the long run behavior of these variables which is qualitatively consistent with the stylized time series facts we documented in Chapter 4.

In the augmented model, we conclude that the only way for the economy to grow over long periods of time is from growth in productivity and population. For per capita variables to grow, productivity must grow. Increasing the saving rate does not result in sustained growth. In a sense, this is a bit of a negative result from the model, since the model takes productivity growth to be exogenous (i.e. external to the model). But this result does pinpoint where sustained growth must come from – it must come from productivity. What exactly is productivity? How can we make it grow faster? Will productivity growth continue forever into the future? We address these questions in this chapter.

6.1 Introducing Productivity and Population Growth

The production function is qualitatively identical to what was assumed in Chapter 5, given by equation (5.1). What is different is how we define labor input. In particular, suppose that the production function is given by:

$$Y_t = AF(K_t, Z_t N_t). \quad (6.1)$$

Here, Y_t is output, A is a measure of productivity which is assumed to be constant going

forward in time, and K_t is capital. N_t is still labor input. The new variable is Z_t . We refer to Z_t as “labor augmenting productivity.” The product of this variable and labor input is what we will call “efficiency units of labor.” Concretely, consider an economy with $N_{1,t} = 10$ and $Z_{1,t} = 1$. Then there are 10 efficiency units of labor. Consider another economy with the same labor input, $N_{2,t} = 10$, but suppose $Z_{2,t} = 2$. Then this economy has 20 efficiency units of labor. Even though the economies have the same amount of labor, it is as if the second economy has double the labor input. An equivalent way to think about this is that the second economy could produce the same amount (assuming equal capital stocks and equal values of A_t) with half of the actual labor input.

At a fundamental level, A and Z_t are both measures of productivity and are both taken to be exogenous to the model. The higher are either of these variables, the bigger will be Y_t for given amounts of K_t and N_t . We refer to A as “neutral” productivity because it makes *both* capital and labor more productive. Z_t is labor augmenting productivity because it only (directly) makes labor more productive. We will make another distinction between the two, which is not necessary but which simplifies our analysis below. In particular, we will use Z_t to control *growth rates* of productivity in the long run, while A will impact the *level* of productivity. For this reason, as Z_t will be evolving going forward in time while A will not, we need to keep a time subscript on Z_t but can dispense with it (as we did in the previous chapter) for A . This ought to become clearer in the analysis below.

The function, $F(\cdot)$, has the same properties laid out in Chapter 5: it is increasing in both arguments (first partial derivatives positive), concave in both arguments (second partial derivatives negative), with a positive cross-partial derivative, and constant returns to scale. The rest of the setup of the model is identical to what we had in the previous chapter. In particular, we have:

$$K_{t+1} = I_t + (1 - \delta)K_t \quad (6.2)$$

$$I_t = sY_t. \quad (6.3)$$

The real wage and rental rate on capital are still equal to the marginal products of capital and labor. For the rental rate, this is:

$$R_t = AF_K(K_t, Z_t N_t). \quad (6.4)$$

For the real wage, we have to be somewhat careful – we will have w_t equal the marginal product of labor, but it is important to note that the marginal product of labor is the partial derivative of the production function with respect to actual labor, N_t , not efficiency units of

labor, $Z_t N_t$. This means that the real wage can be written:

$$w_t = AZ_t F_N(K_t, Z_t N_t). \quad (6.5)$$

Why does the Z_t show up outside of $F_N(\cdot)$ in (6.5)? $F_N(\cdot)$ here denotes the partial derivative of $F(\cdot)$ with respect to the argument $Z_t N_t$; the derivative of $Z_t N_t$ with respect to N_t is Z_t . Hence, we are using the chain rule to derive (6.5).

We will make two assumptions on how N_t and Z_t evolve over time. Like we did in Chapter 5, we will assume that labor is supplied inelastically (meaning it doesn't depend on the wage or anything else in the model). Unlike Chapter 5, however, we will allow N_t to grow over time to account for population growth. In particular, let's assume:

$$N_t = (1 + n)N_{t-1}, \quad n \geq 0. \quad (6.6)$$

In other words, we allow N_t to grow over time, where $n \geq 0$ is the growth rate between two periods. If we iterate back to period 0, and normalize the initial level $N_0 = 1$, then we get:

$$N_t = (1 + n)^t. \quad (6.7)$$

Equation (6.7) embeds what we had in the previous chapter as a special case. In particular, if $n = 0$, then $N_t = 1$ at all times. What we are assuming is that time begins in period $t = 0$ with a representative household which supplies $N_0 = 1$ unit of labor. Over time, the size of this household grows at rate n , but each member of the household continues to supply 1 unit of labor inelastically each period.

We will also allow Z_t to change over time. In particular, assume:

$$Z_t = (1 + z)Z_{t-1}, \quad z \geq 0. \quad (6.8)$$

Here, $z \geq 0$ is the growth rate of Z_t across periods. As with labor input, normalize the period 0 level to $Z_0 = 1$ and iterate backwards, meaning we can write (6.8) as:

$$Z_t = (1 + z)^t. \quad (6.9)$$

Again, the setup we had in Chapter 5 is a special case of this. When $z = 0$, then $Z_t = 1$ at all times and could be omitted from the analysis. As we will see below, $z > 0$ is going to be the factor which allows the model to account for growth in output per worker in the long run.

In summary, the equations characterizing the augmented Solow model can be written:

$$K_{t+1} = I_t + (1 - \delta)K_t \quad (6.10)$$

$$I_t = sY_t \quad (6.11)$$

$$Y_t = AF(K_t, Z_tN_t) \quad (6.12)$$

$$Y_t = C_t + I_t \quad (6.13)$$

$$R_t = AF_K(K_t, Z_tN_t) \quad (6.14)$$

$$N_t = (1 + n)^t \quad (6.15)$$

$$Z_t = (1 + z)^t \quad (6.16)$$

$$w_t = AZ_tF_N(K_t, Z_tN_t). \quad (6.17)$$

The behavior of the capital stock is what drives everything else. As in Chapter 5, we can combine equations to focus on the capital accumulation:

$$K_{t+1} = sAF(K_t, Z_tN_t) + (1 - \delta)K_t. \quad (6.18)$$

(6.18) describes how the capital stock evolves, given an exogenous initial capital stock, K_t , the exogenous levels of N_t and Z_t (which evolve according to (6.15) and (6.16)), the exogenous value of A , and the value of the parameters s and δ . Once we know how K_t evolves across time, we can figure out what everything else is.

As in Chapter 5, for the analysis to follow it is helpful to re-write the equations in transformed variables. In Chapter 5, we re-wrote the equations in terms of per worker variables, with $x_t = X_t/N_t$ denoting a per worker version of some variable X_t . Let's now re-write the equations in terms of *per efficiency units of labor*. In particular, for some variable X_t , define $\widehat{x}_t = \frac{X_t}{Z_tN_t}$. Transforming the variables in this way is useful because variables relative to per efficiency units of labor will converge to a steady state, while per worker / per capita variables and level variables will not.

Let's start with the capital accumulation equation. Begin by dividing both sides of (6.18) by Z_tN_t :

$$\frac{K_{t+1}}{Z_tN_t} = \frac{sAF(K_t, Z_tN_t)}{Z_tN_t} + (1 - \delta)\frac{K_t}{Z_tN_t}. \quad (6.19)$$

Because we continue to assume that $F(\cdot)$ has constant returns to scale, we know that $\frac{F(K_t, Z_tN_t)}{Z_tN_t} = F\left(\frac{K_t}{Z_tN_t}, \frac{Z_tN_t}{Z_tN_t}\right) = F(\widehat{k}_t, 1)$. Define $f(\widehat{k}_t) = F(\widehat{k}_t, 1)$. Hence, (6.19) can be written:

$$\frac{K_{t+1}}{Z_tN_t} = sAf(\widehat{k}_t) + (1 - \delta)\widehat{k}_t. \quad (6.20)$$

To get the left hand side of (6.20) in terms of \widehat{k}_{t+1} , we need to multiply and divide by $Z_{t+1}N_{t+1}$ as follows:

$$\frac{K_{t+1}}{Z_{t+1}N_{t+1}} \frac{Z_{t+1}N_{t+1}}{Z_t N_t} = sAf(\widehat{k}_t) + (1 - \delta)\widehat{k}_t. \quad (6.21)$$

From (6.6) and (6.8), we know that $Z_{t+1}/Z_t = (1 + z)$ and $N_{t+1}/N_t = (1 + n)$. Hence, we can write the capital accumulation equation in terms of per efficiency units of capital as:

$$\widehat{k}_{t+1} = \frac{1}{(1 + z)(1 + n)} [sAf(\widehat{k}_t) + (1 - \delta)\widehat{k}_t]. \quad (6.22)$$

The other equations of the model can be re-written in terms of efficiency units as follows:

$$\widehat{i}_t = s\widehat{y}_t \quad (6.23)$$

$$\widehat{y}_t = Af(\widehat{k}_t) \quad (6.24)$$

$$\widehat{y}_t = \widehat{c}_t + \widehat{i}_t \quad (6.25)$$

$$R_t = Af'(\widehat{k}_t) \quad (6.26)$$

$$w_t = Z_t [Af(\widehat{k}_t) - Af'(\widehat{k}_t)\widehat{k}_t]. \quad (6.27)$$

Mathematical Diversion

How does one derive equations (6.23)–(6.27)? Here, we will go step by step.

Start with (6.11). Divide both sides by $Z_t N_t$:

$$\begin{aligned} \frac{I_t}{Z_t N_t} &= s \frac{Y_t}{Z_t N_t} \\ \Rightarrow \widehat{i}_t &= s\widehat{y}_t. \end{aligned} \quad (6.28)$$

Similarly, divide both sides of (6.12) by $Z_t N_t$:

$$\frac{Y_t}{Z_t N_t} = \frac{AF(K_t, Z_t N_t)}{Z_t N_t} \quad (6.29)$$

$$\widehat{y}_t = AF\left(\frac{K_t}{Z_t N_t}, \frac{Z_t N_t}{Z_t N_t}\right) \quad (6.30)$$

$$\widehat{y}_t = AF(\widehat{k}_t, 1) \quad (6.31)$$

$$\widehat{y}_t = Af(\widehat{k}_t). \quad (6.32)$$

Next, divide both sides of (6.13) by $Z_t N_t$:

$$\begin{aligned}\frac{Y_t}{Z_t N_t} &= \frac{C_t}{Z_t N_t} + \frac{I_t}{Z_t N_t} \\ \Rightarrow \widehat{y}_t &= \widehat{c}_t + \widehat{i}_t.\end{aligned}\tag{6.33}$$

For the rental rate on capital, note that, because $F(\cdot)$ is constant returns to scale, the partial derivatives are homogeneous of degree 0. This means:

$$R_t = AF_K(K_t, Z_t N_t)\tag{6.34}$$

$$R_t = AF_K\left(\frac{K_t}{Z_t N_t}, \frac{Z_t N_t}{Z_t N_t}\right)\tag{6.35}$$

$$R_t = Af'(\widehat{k}_t).\tag{6.36}$$

For the wage, because of Euler's theorem for homogeneous functions, we know that:

$$F(K_t, Z_t N_t) = F_K(K_t, Z_t N_t)K_t + F_N(K_t, Z_t N_t)Z_t N_t.\tag{6.37}$$

Divide both sides by $Z_t N_t$:

$$\frac{F(K_t, Z_t N_t)}{Z_t N_t} = F_K(K_t, Z_t N_t)\widehat{k}_t + F_N(K_t, Z_t N_t).\tag{6.38}$$

Since $F(\cdot)$ is homogeneous of degree 1, this can be written:

$$f(\widehat{k}_t) - f'(\widehat{k}_t) = F_N(K_t, Z_t N_t).\tag{6.39}$$

Since $w_t = Z_t AF_N(K_t, Z_t N_t)$. This means that:

$$Z_t AF_N(K_t, Z_t N_t) = Z_t [Af(\widehat{k}_t) - Af'(\widehat{k}_t)\widehat{k}_t].\tag{6.40}$$

6.2 Graphical Analysis of the Augmented Model

We can proceed with a graphical analysis of the augmented Solow model in a way similar to what we did in Chapter 5. Differently than that model, we graphically analyze the capital stock per efficiency units of labor, rather than capital per unit of labor.

We wish to plot (6.22). We plot \widehat{k}_{t+1} against \widehat{k}_t . The plot starts in the origin. It increases at a decreasing rate. Qualitatively, the plot looks *exactly* the same as in the previous chapter

(see Figure 5.1). The only slight difference is that the right hand side is scaled by $\frac{1}{(1+z)(1+n)}$, which is less than or equal to 1.

Figure 6.1: Plot of Central Equation of Augmented Solow Model

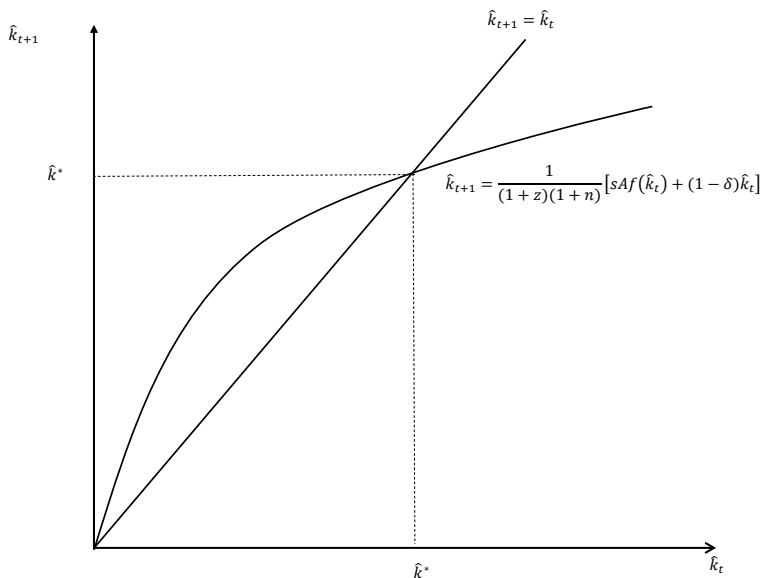

As in the previous chapter, we plot a 45 degree line, showing all parts where $\widehat{k}_{t+1} = \widehat{k}_t$. Via exactly the same arguments as in the basic Solow model, the plot of \widehat{k}_{t+1} against \widehat{k}_t must cross this 45 degree line exactly once (other than at the origin). We call this point the steady state capital stock per efficiency unit of labor, \widehat{k}^* . Moreover, via exactly the same arguments as before, the economy naturally converges to this point from any initial starting point. While we are not per se interested in per efficiency unit of labor variables, knowing that the economy converges to a steady state in these variables facilitates analyzing the behavior of per worker and level variables.

6.3 The Steady State of the Augmented Model

Graphically, we see that the economy converges to a steady state capital stock per efficiency unit of labor. Once we know what is happening to \widehat{k}_t , everything else can be figured out from equations (6.23)–(6.27).

It is important to note that we are not really particularly interested in the behavior of the “hat” variables (the per efficiency units of labor variables). Writing the model in terms of these variables is just a convenient thing to do, because the model converges to a steady state in these variables. In this section, we pose the question: what happens to per worker

and actual variables once the economy has converged to the steady state in the per efficiency variables?

Note that being at \widehat{k}^* means that $\widehat{k}_{t+1} = \widehat{k}_t$. Recall the definitions of these variables: $\widehat{k}_{t+1} = \frac{K_{t+1}}{Z_{t+1}N_{t+1}}$ and $\widehat{k}_t = \frac{K_t}{Z_t N_t}$. Equate these and simplify:

$$\frac{K_{t+1}}{Z_{t+1}N_{t+1}} = \frac{K_t}{Z_t N_t} \quad (6.41)$$

$$\frac{K_{t+1}}{K_t} = \frac{Z_{t+1}N_{t+1}}{Z_t N_t} \quad (6.42)$$

$$\frac{K_{t+1}}{K_t} = (1+z)(1+n). \quad (6.43)$$

Here, $\frac{K_{t+1}}{K_t}$ is the gross growth rate of the capital stock, i.e. $1 + g_K$. This tells us that, in the steady state in the efficiency units of labor variables, capital grows at the product of the growth rates of Z_t and N_t :

$$\begin{aligned} 1 + g_K &= (1+z)(1+n) \\ \Rightarrow g_K &\approx z + n. \end{aligned} \quad (6.44)$$

The approximation makes use of the fact that $zn \approx 0$. We can also re-arrange (6.44) to look at the growth rate of the capital stock per worker:

$$\frac{K_{t+1}}{N_{t+1}} = \frac{Z_{t+1}}{Z_t} \frac{K_t}{N_t} \quad (6.45)$$

$$\frac{k_{t+1}}{k_t} = 1 + z \Rightarrow g_k = z. \quad (6.46)$$

In other words, the capital stock per worker grows at the growth rate of Z_t , z , in steady state. The same expressions hold true for output, consumption, and investment:

$$\frac{Y_{t+1}}{Y_t} = (1+z)(1+n) \Rightarrow g_Y \approx z + n \quad (6.47)$$

$$\frac{C_{t+1}}{C_t} = (1+z)(1+n) \Rightarrow g_C \approx z + n \quad (6.48)$$

$$\frac{I_{t+1}}{I_t} = (1+z)(1+n) \Rightarrow g_I \approx z + n. \quad (6.49)$$

This also applies to the per worker versions of these variables:

$$\frac{y_{t+1}}{y_t} = (1 + z) \Rightarrow g_y = z \quad (6.50)$$

$$\frac{c_{t+1}}{c_t} = (1 + z) \Rightarrow g_c = z \quad (6.51)$$

$$\frac{i_{t+1}}{i_t} = (1 + z) \Rightarrow g_i = z. \quad (6.52)$$

In other words, the economy naturally will converge to a steady state in the per efficiency units of variables. In this steady state, output and capital per worker will grow at constant rates, equal to z . These are the same rates, so the capital-output ratio will be constant in the steady state. These results are consistent with the stylized facts presented in Chapter 4.

What will happen to factor prices in the steady state? Recall that $R_t = Af'(\widehat{k}_t)$. Since $\widehat{k}_t \rightarrow \widehat{k}^*$, and A does not grow in steady state, this means that there exists a steady state rental rate:

$$R^* = Af'(\widehat{k}^*). \quad (6.53)$$

This will be constant across time. In other words, $R_{t+1}/R_t = 1$, so the rental rate is constant in the steady state. This is consistent with the stylized fact that the return on capital is constant over long stretches of time.

What about the real wage? Evaluate (6.27) once $\widehat{k}_t \rightarrow \widehat{k}^*$:

$$w_t = Z_t [Af(\widehat{k}^*) - Af'(\widehat{k}^*)\widehat{k}^*] \quad (6.54)$$

The term inside the brackets in (6.54) does not vary over time, but the Z_t does. Taking this expression led forward one period, and dividing it by the period t expression, we get:

$$\begin{aligned} \frac{w_{t+1}}{w_t} &= \frac{Z_{t+1}}{Z_t} \\ &= 1 + z \\ \Rightarrow g_w &= z. \end{aligned} \quad (6.55)$$

In other words, once the economy has converged to a steady state in the per efficiency units of labor variables, the real wage will grow at a constant rate, equal to the growth rate of Z_t , z . This is the same growth rate as output per worker in the steady state. This is also consistent with the stylized facts presented in Chapter 4. Finally, since w_t and $y_t = Y_t/N_t$ both grow at rate z , labor's share of income is constant, also consistent with the time series stylized facts.

In other words, the augmented Solow model converges to a steady state in per efficiency units of labor variables. Since the economy converges to this steady state from any initial

starting point, it is reasonable to conclude that this steady state represents where the economy sits on average over long periods of time. At this steady state, per worker variables and factor prices behave exactly as they do in the stylized facts presented in Chapter 4. To the extent to which a model is judged by the quality of the predictions it makes, the augmented Solow model is a good model.

6.4 Experiments: Changes in s and A

Let us consider the same experiments considered in Chapter 5 in the augmented model: permanent, surprise increases in s or A . Let us first start with an increase in s . Suppose that the economy initially sits in a steady state associated with s_0 . Then, in period t , the saving rate increases to $s_1 > s_0$ and is expected to remain forever at the higher rate. Qualitatively, this has exactly the same effects as it does in the basic model. This can be seen in Figure 6.2:

Figure 6.2: Increase in s

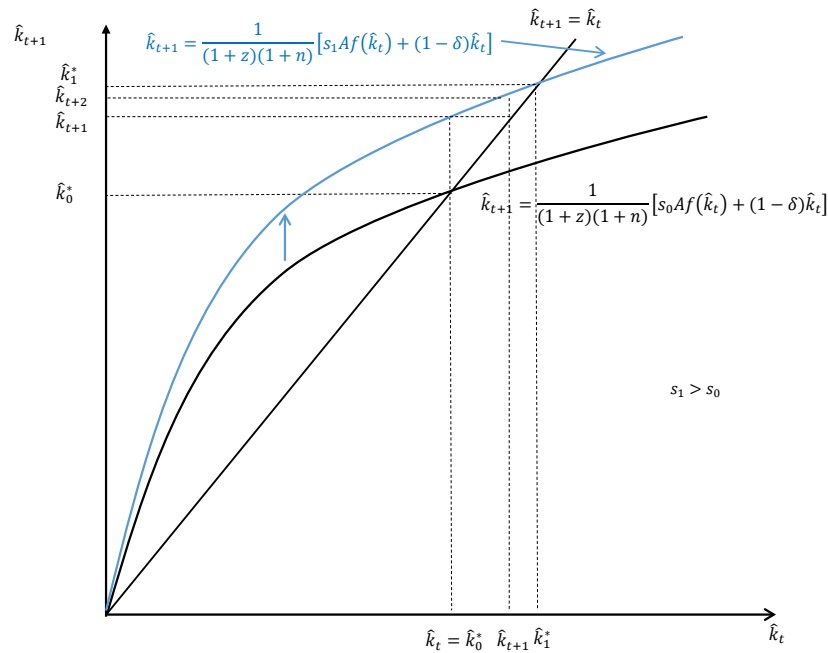

The steady state capital stock per efficiency unit of labor increases. The capital stock per efficiency unit of labor starts obeying the dynamics governed by the blue curve and approaches the new steady state. Given the dynamics of \widehat{k}_t , we can infer the dynamic responses of the other variables. These dynamic responses are shown in Figure 6.3 below.

With the exception of the behavior of w_t , these look exactly as they did after an increase in s in the basic model. The path of w_t looks different, because, as shown above in (6.27), the

wage depends on Z_t , and so inherits growth from Z_t in the steady state. After the increase in s , the wage grows faster for a time as capital per efficiency unit of labor is accumulated. This means that the path of w_t is forever on a higher level trajectory, but eventually the growth rate of w_t settles back to where it would have been in the absence of the change in s .

Figure 6.3: Dynamic Responses to Increase in s

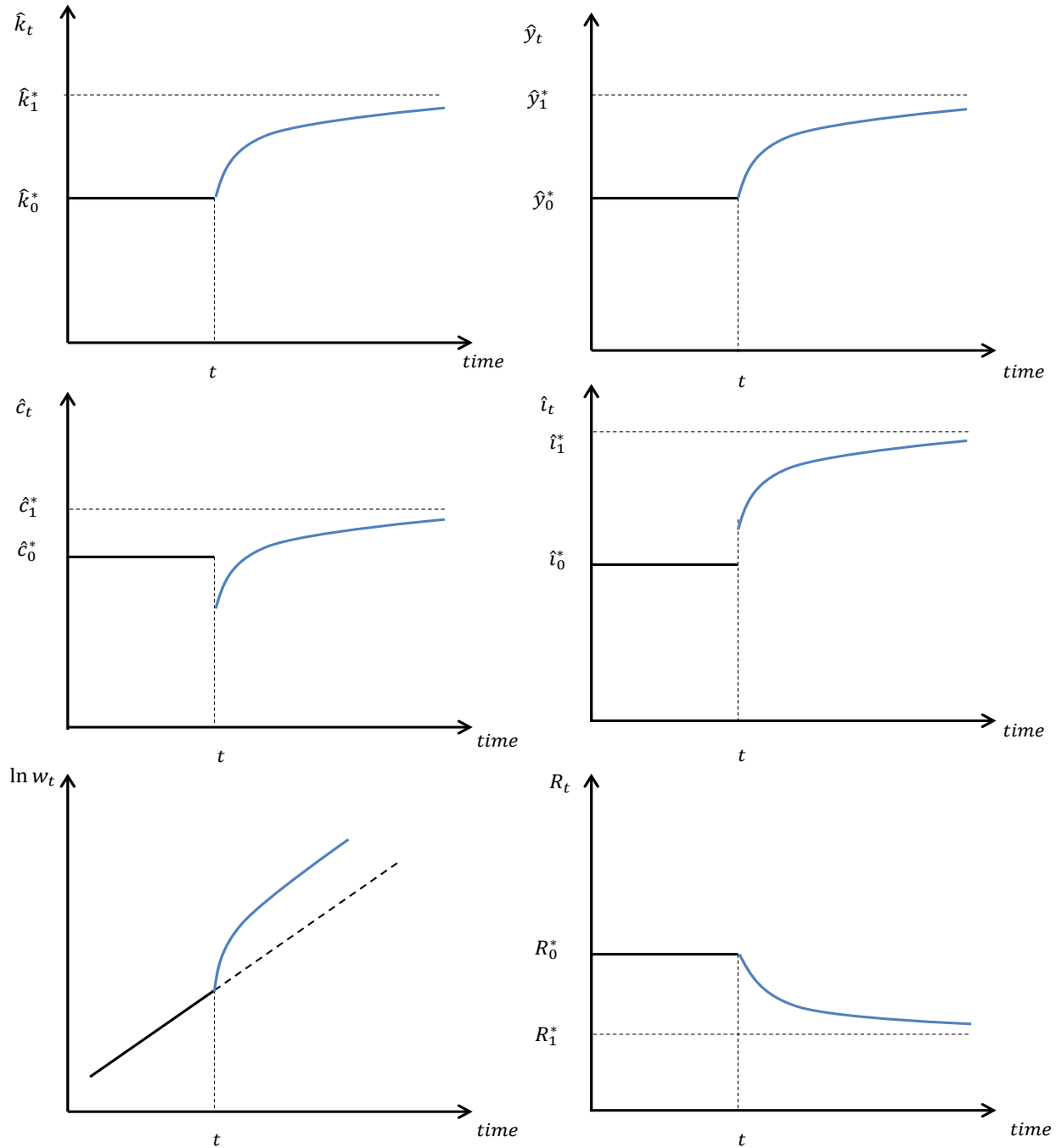

What we are really interested in is not the behavior of the per efficiency units of labor

variables, but rather the per worker variables. Once we know what is going on with the per efficiency unit variables, it is straightforward to recover what happens to the per worker variables, since $x_t = \hat{x}_t Z_t$, for some variable X_t .

Figure 6.4: Dynamic Responses to Increase in s , Per Worker Variables

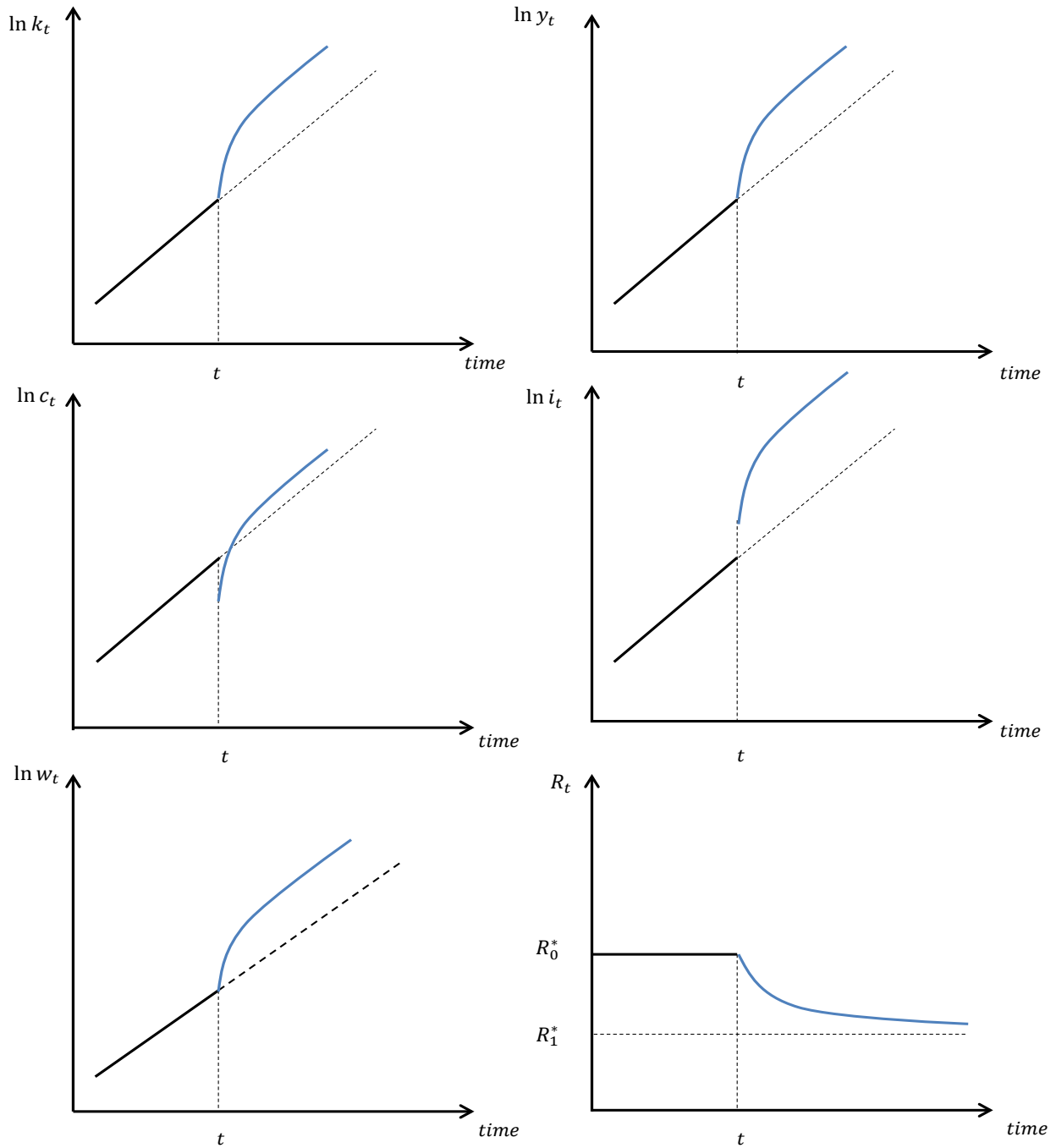

The paths of the per worker variables are shown in Figure 6.4. These look similar to what is shown in Figure 6.3, but these variables grow in the steady state. So, prior to the increase

in s , y_t , k_t , c_t , and i_t would all be growing at rate z . Then, after the saving rate increase, these variables grow faster for a while. This puts them on a forever higher level trajectory, but eventually the faster growth coming from more capital accumulation dissipates, and these variables grow at the same rate they would have in the absence of the increase in s .

The dynamic path of the growth rate of output per worker after the increase in s can be seen in Figure 6.5 below. This looks very similar to Figure 5.8 from the previous chapter, with the exception that output growth starts and ends at $z \geq 0$, instead of 0. In other words, increasing the saving rate can temporarily boost growth, but not permanently.

Figure 6.5: Dynamic Path of Output Per Worker Growth

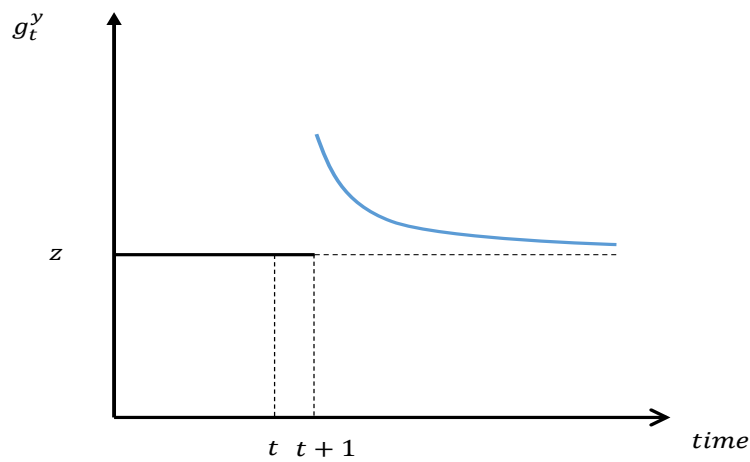

Next, consider a one time level increase in A from $A_{0,t}$ to $A_{1,t}$. In terms of the main diagram, this has effects very similar to those of an increase in the saving rate, as can be seen in Figure 6.6:

Figure 6.6: Increase in A

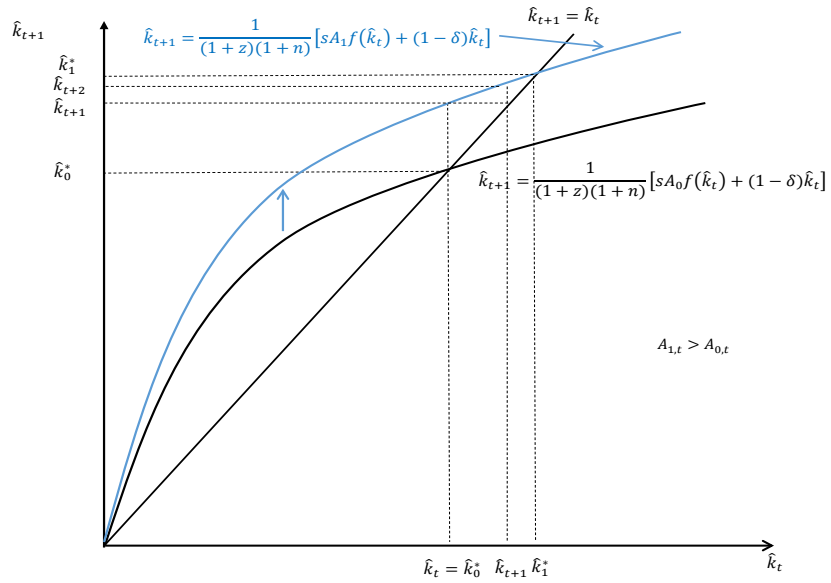

Given the inferred dynamic path of \hat{k}_t from Figure 6.6, the paths of the other variables can be backed out. These are shown below:

Figure 6.7: Dynamic Responses to Increase in A

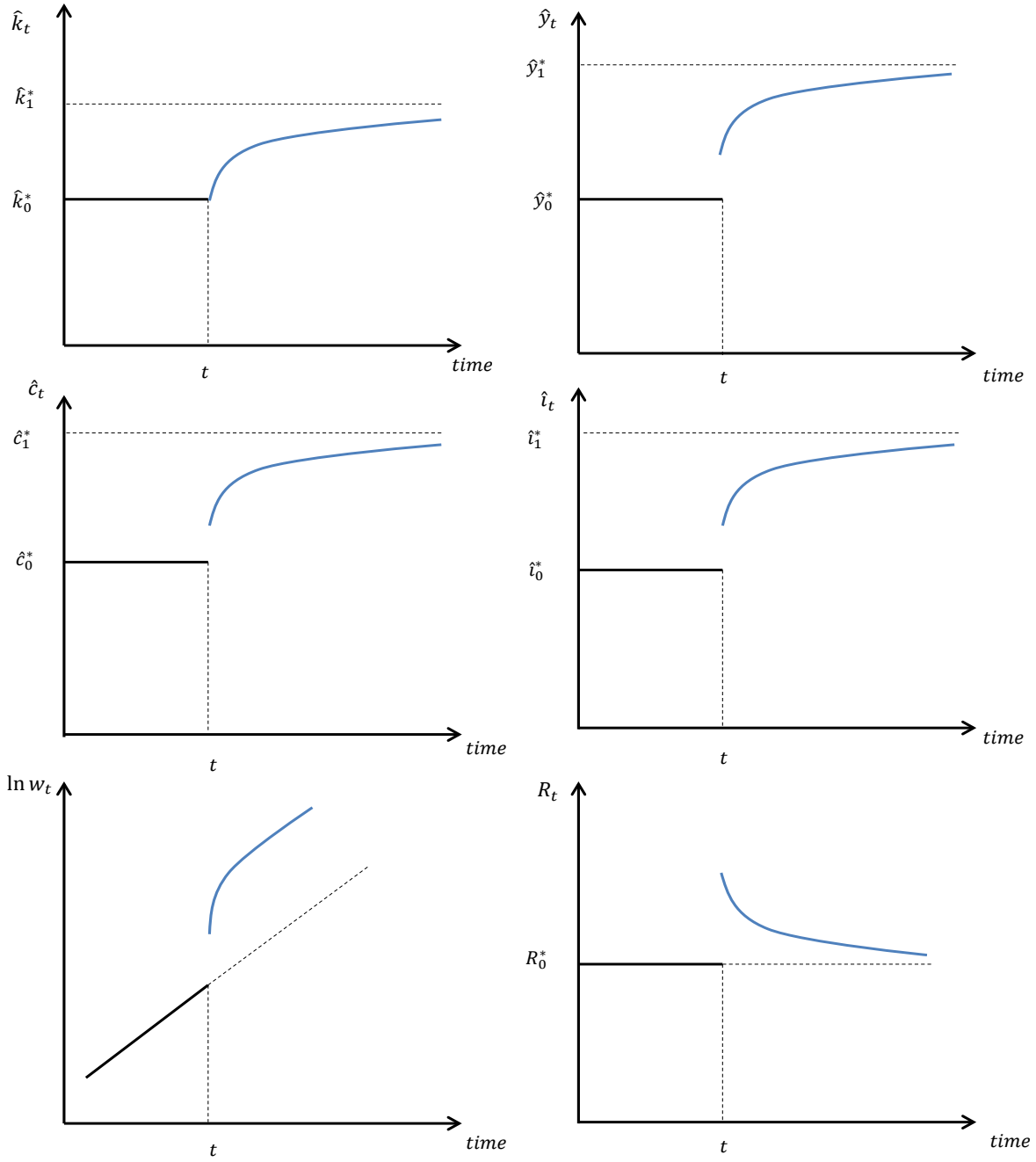

As in the case of the increase in s , we can transform these into paths of the per worker variables by multiplying by Z_t . These paths are shown in Figure 6.8:

Figure 6.8: Dynamic Responses to Increase in A , Per Worker Variables

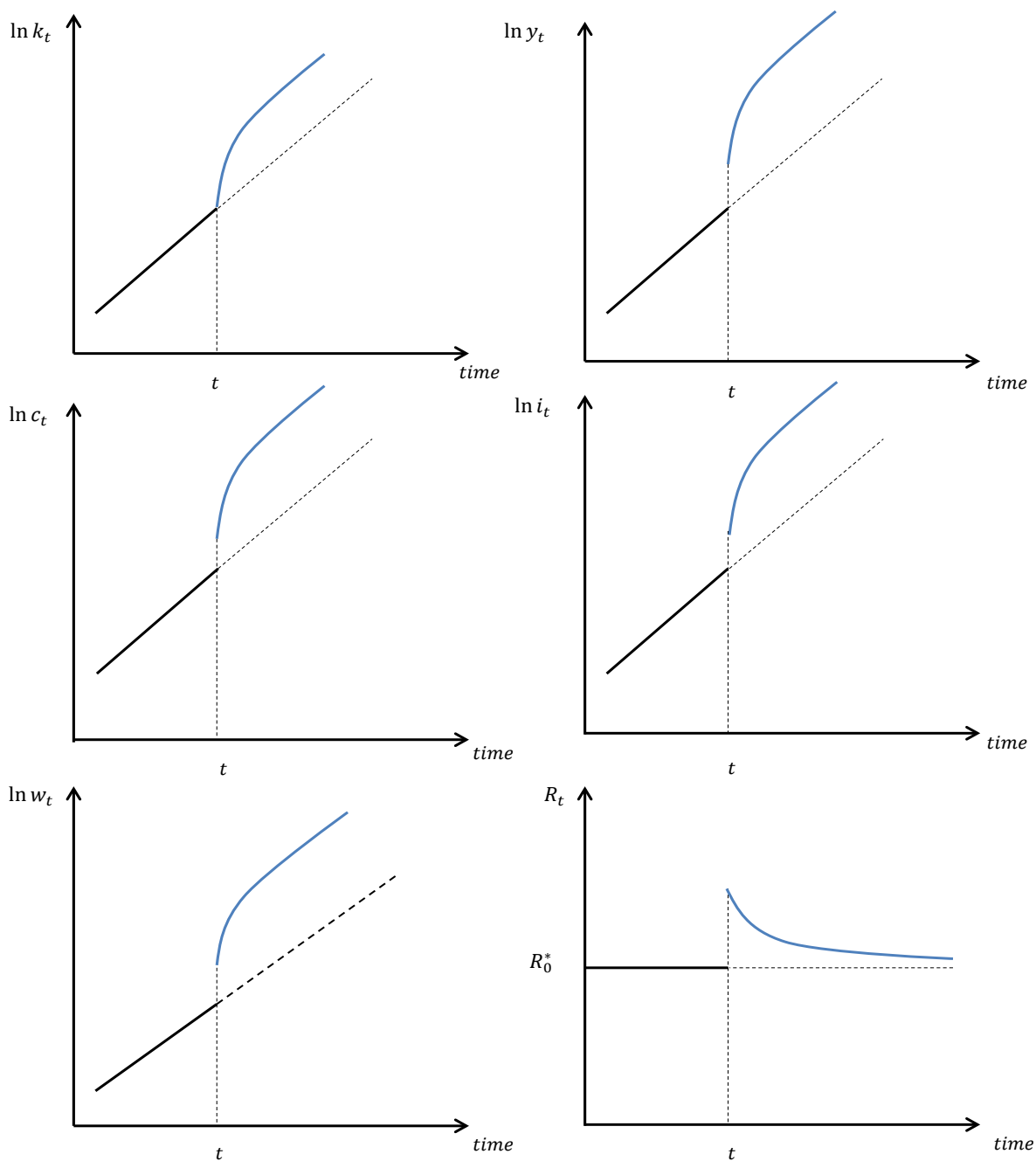

Example

The preceding analysis is all qualitative. It is possible to do similar exercises quantitatively, using a program like Excel. To do things quantitatively, we need to make a functional form assumption on the production function. Let us assume that it is Cobb-Douglas:

$$Y_t = AK_t^\alpha (Z_t N_t)^{1-\alpha}. \quad (6.56)$$

The accumulation equation for the capital stock per efficiency unit of labor is:

$$\widehat{k}_{t+1} = \frac{1}{(1+z)(1+n)} [sA\widehat{k}_t^\alpha + (1-\delta)\widehat{k}_t]. \quad (6.57)$$

In terms of the per efficiency unit variables, the variables of the model can be written solely in terms of the capital stock per efficiency units of labor:

$$\widehat{y}_t = A\widehat{k}_t^\alpha \quad (6.58)$$

$$\widehat{c}_t = (1-s)A\widehat{k}_t^\alpha \quad (6.59)$$

$$\widehat{i}_t = sA\widehat{k}_t^\alpha \quad (6.60)$$

$$R_t = \alpha A\widehat{k}_t^{\alpha-1} \quad (6.61)$$

$$w_t = Z_t(1-\alpha)A\widehat{k}_t^\alpha. \quad (6.62)$$

One can solve for the steady state capital stock per efficiency unit of labor by setting $\widehat{k}_{t+1} = \widehat{k}_t = \widehat{k}^*$ and solving (6.57):

$$\widehat{k}^* = \left[\frac{sA}{(1+z)(1+n) - (1-\delta)} \right]^{\frac{1}{1-\alpha}}. \quad (6.63)$$

To proceed quantitatively, we need to assign values to the parameters. Let's assume that $s = 0.2$, $A = 1$, $\delta = 0.1$, and $\alpha = 0.33$. Furthermore, assume that $z = 0.02$ and $n = 0.01$. This means that Z_t grows at a rate of 2 percent per year and N_t grows at a rate of 1 percent per year, while the capital stock depreciates at a rate of 10 percent per year. With these parameters, the steady state capital stock per efficiency unit of labor is 1.897.

Assume that time begins in period $t = 0$. From (6.15)–(6.16), this means that the initial values of Z_t and N_t are both 1. Assume that the capital stock per efficiency unit of labor begins in steady state. Once we know \widehat{k}_t in the first period, as well as the initial level of Z_t , one can use (6.58)–(6.62) to determine values of \widehat{y}_t , \widehat{c}_t , \widehat{i}_t , R_t , and w_t . We can also determine levels of the per worker variables, k_t , y_t , c_t , and i_t , by multiplying the per efficiency unit of labor variables by the level of Z_t . Given an initial value of \widehat{k}_t in period $t = 0$, we can determine the value in the next period using Equation (6.57). Once we know \widehat{k}_{t+1} , we can then determine the per

efficiency unit of labor and per worker versions of the remaining variables. We can then continue to iterate this procedure moving forward in time (by simply filling formulas in an Excel worksheet). Since we assume that we begin in the steady state, the per efficiency unit variables will remain in that steady state until something changes.

Consider the following experiment. From periods $t = 0$ through $t = 8$, the economy sits in the steady state. Then, in period $t = 9$, the saving rate increases from 0.2 to 0.3, and is forever expected to remain at this higher level. Using the new value of the saving rate and the existing capital stock per efficiency unit of labor in period $t = 9$, we can determine values of all the other variables in that period. Then we can use (6.57) to determine the period 10 value of the capital stock per efficiency unit of labor, and then use this to compute values of all the other variables.

Figure 6.9: Dynamic Responses to Increase in s , Quantitative Exercise

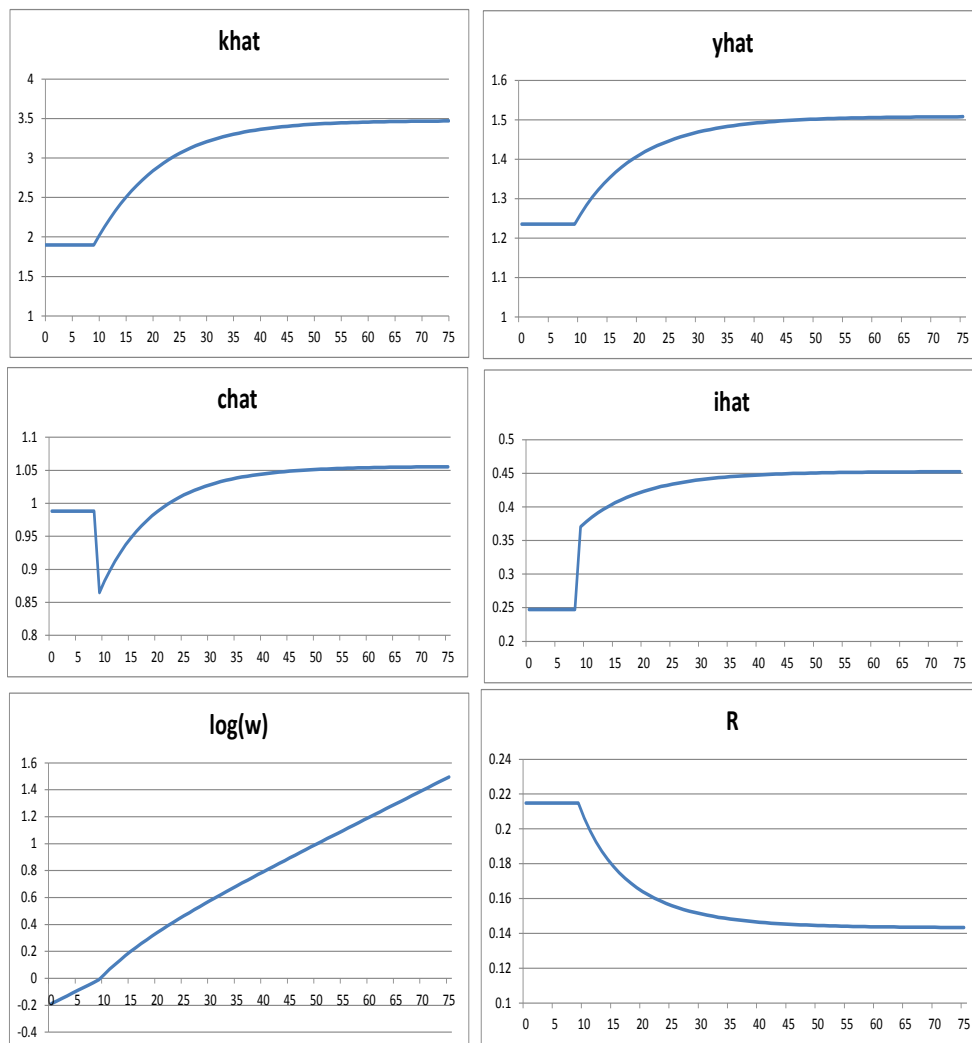

Figure 6.9 plots the dynamic paths of the per efficiency unit variables, as well as the real wage and rental rate on capital, from periods $t = 0$ to $t = 75$. The saving rate changes in period 9. These plots look similar to what is shown in Figure 6.3. We plot the natural log of the wage, since it grows as Z_t grows and plotting in the log makes the picture easier to interpret.

Figure 6.10 plots the log levels of the per worker variables from the same experiment. This figure looks similar to Figure 6.4. The higher saving rate causes variables to grow faster for a while. They end up on a permanently higher level trajectory, but the slope of the plots is eventually the same as it would have been had the saving rate remained constant.

Figure 6.10: Dynamic Responses to Increase in s , Quantitative Exercise, Per Worker Variables

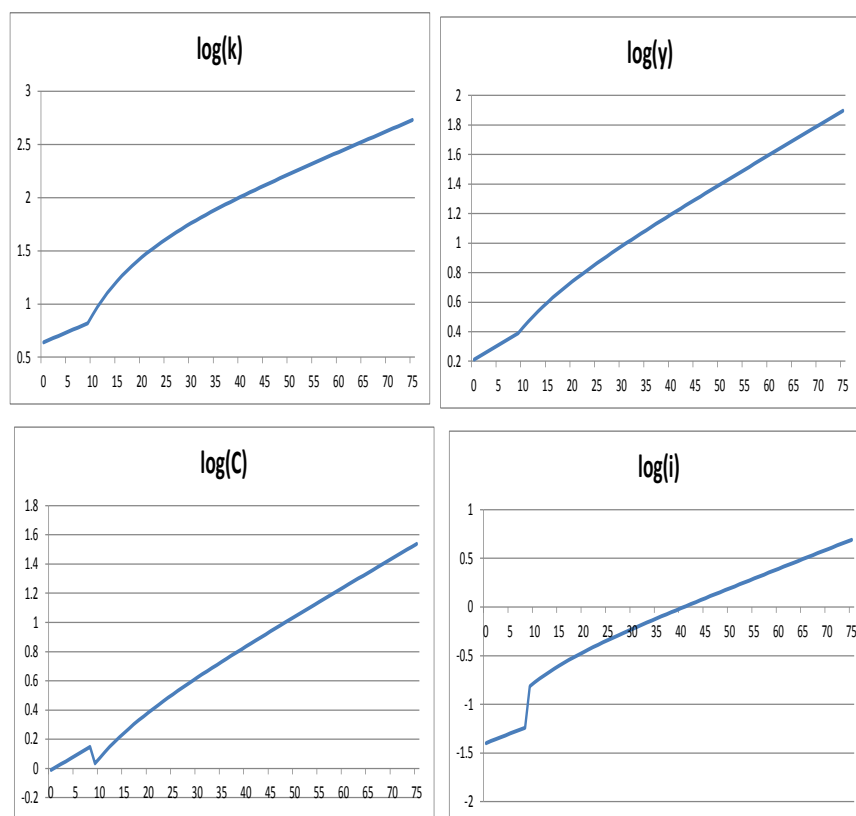
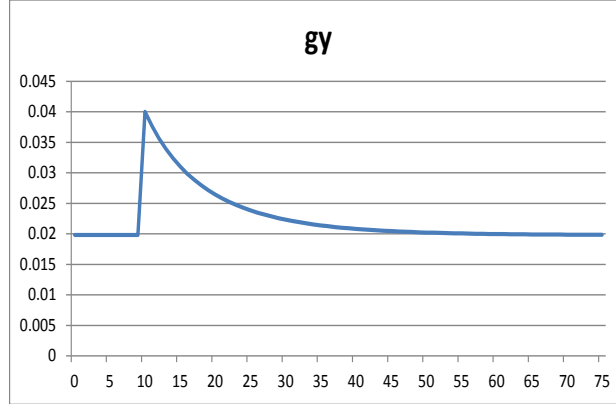

Figure 6.11 plots the growth rate of output per worker (the log first difference of output per worker). Prior to period 9, the growth rate is constant at 2 percent. Then, starting in period 10 (the period after the increase in s), the growth rate jumps up. It remains higher than before for several periods, but eventually comes back to where it began. This illustrates the key point that saving more can

temporarily boost growth, but not for a long period of time. Over long periods of time, the growth rate of output per worker is driven by the growth rate of labor augmenting technology, z .

Figure 6.11: Dynamic Responses to Increase in s , Quantitative Exercise
Per Worker Output Growth



6.5 The Golden Rule

The Golden Rule saving rate is defined in a similar way to Chapter 5. It is the s which maximizes \widehat{c}^* (i.e. the saving rate which maximizes the steady state value of consumption per efficiency unit of labor). We can think about the Golden Rule graphically in a way similar to what we did in Chapter 5. But before doing so, we must ask ourselves, what must be true about steady state investment per efficiency unit of labor. Write the capital accumulation equation in terms of investment as follows:

$$(1+z)(1+n)\widehat{k}_{t+1} = \widehat{i}_t + (1-\delta)\widehat{k}_t. \quad (6.64)$$

In the steady state, $\widehat{k}_{t+1} = \widehat{k}_t$. This means:

$$\widehat{i}_t = [(1+z)(1+n) - (1-\delta)]\widehat{k}_t. \quad (6.65)$$

Note that $(1+z)(1+n) - (1-\delta) \approx z+n+\delta$ (since $zn \approx 0$). This implies that in steady state:

$$\widehat{i}_t = (z+n+\delta)\widehat{k}_t. \quad (6.66)$$

(6.66) is “break-even” investment per efficiency unit of labor – i.e. the amount of investment per efficiency unit of labor necessary to keep the capital stock per efficiency unit of labor from declining. What is slightly different from the previous chapter is that break-even

investment depends not just on the depreciation rate but also the growth rates of labor augmenting productivity and population. Put slightly differently, in the augmented model capital per efficiency unit of labor will naturally decline over time due to (i) depreciation of physical capital, δ ; (ii) more labor input through population growth, n ; (iii) more productive labor input through productivity growth, z . Break-even investment needs to cover all three of these factors to keep the capital stock per efficiency unit of labor constant.

In a graph with \widehat{k}_t on the horizontal axis, let us plot \widehat{y}_t , \widehat{i}_t , and $(z+n+\delta)\widehat{k}_t$ (i.e. break-even investment) against \widehat{k}_t :

Figure 6.12: The Golden Rule Saving Rate

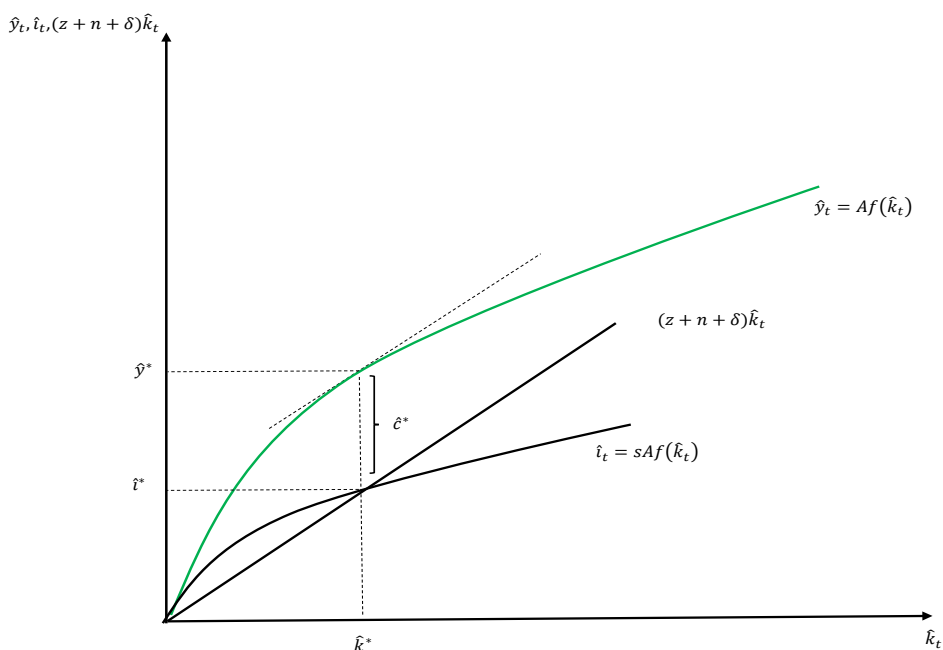

\widehat{c}_t is given by the vertical distance between the plots of \widehat{y}_t and \widehat{i}_t , given a value of \widehat{k}_t . The steady state occurs where the plot of \widehat{i}_t crosses the line $(z+n+\delta)\widehat{k}_t$. Hence, the steady state level of consumption per efficiency unit of labor is given by the vertical distance between the plot of \widehat{y}_t and the plot of \widehat{i}_t at the value \widehat{k}^* . This vertical distance is maximized when the slope of the \widehat{y}_t plot is equal to the slope of the $(z+n+\delta)\widehat{k}_t$ plot, which means:

$$Af'(\widehat{k}^*) = z + n + \delta. \quad (6.67)$$

In words, the Golden rule s is the s which generates a \widehat{k}^* where the marginal product of capital equals $z+n+\delta$. If $z=n=0$, then this is the same condition we saw in the basic model.

6.6 Will Economic Growth Continue Indefinitely?

In the augmented Solow model, we can generate sustained growth in output per capita by simply assuming that labor augmenting productivity grows at a constant rate. In some sense, this is an unsatisfying result, as the model takes progress in labor augmenting productivity as given and does not seek to explain where it comes from.

In this section we pose the provocative question: will economic growth continue into the indefinite future? The model we have been working with cannot say anything about this, since the long run rate of growth is taken to be exogenous. But some historical perspective might help shed some light on this important question. [Delong \(1998\)](#) provides estimates of world real GDP from the beginning of recorded history to the present. From the the year 1 AD to 1600, worldwide real GDP grew by about 300 percent. While this may sound like a lot, considering compound it is an extremely slow rate of growth – it translates into average annual growth about 0.001, or 0.1 percent per year. In contrast, from 1600 to 2000, world GDP grew by an of about 0.015, or 1.5 percent – about 15 times faster than prior to 1600. Growth over the 20th century has been even higher, at about 3.6 percent per year.

In other words, continuous economic growth is really only a modern phenomenon. For most of recorded human history, there was essentially no growth. Only since the beginning of the Industrial Revolution has the world as a whole witnessed continuous economic growth. While economic growth seems to have accelerated in the last several hundred years, there are some indications that growth is slowing. Since the early 1970s, measured productivity growth in the US has slowed down compared to earlier decades. The recent Great Recession has also seemed to be associated with a continual slowdown in growth.

Is economic growth slowing down? Was the last half millenium an anomaly? Economist Robert Gordon thinks so, at least in part. In [Gordon \(2016\)](#), he argues the period 1870-1970 was a “special century” that witnessed many new inventions and vast improvements in quality of life (e.g. the average life expectancy in the US increased by thirty years). He argues that this period in particular was an anomaly. In essence, his thesis is that we have exhausted most life-changing ideas, and that we cannot depend on continuous large improvements in standards of living going forward.

Not all economists, of course, agree with Gordon’s thesis. It is easy to say conclude that the improvements of the 20th century were historical anomalies after the fact. It is difficult to predict what the future may hold. People in the 18th likely could not conceive of the breakthroughs of the 20th century (like aviation, computing, and telecommunications). Likewise, it is difficult for us in the early 21th century to envision what will happen in the decades to come. Only time will tell.

6.7 Summary

- The augmented Solow model is almost identical to the Solow model of the previous chapter except now there is sustained growth in the population and labor augmenting productivity.
- The effective number of workers equals labor augmenting productivity multiplied by the number of workers. Consequently, the effective number of workers can increase when either the population grows or labor augmenting productivity grows.
- A stable steady-state solution exists in per effective worker variables. At this steady state, output, capital, consumption, and investment all grow at a rate equal to the sum of the growth rates in population and labor augmenting productivity. Per worker (or per capita) variables grow at the growth rate of labor augmenting productivity. The return on capital is constant, and the real wage grows at the rate of growth of labor augmenting productivity. These productions of the augmented Solow model are consistent with the stylized facts.

Key Terms

- Labor augmenting productivity

Questions for Review

1. Explain, in words, what is meant by labor augmenting productivity.
2. Draw the main diagram of the Solow model with both labor augmenting productivity growth and population growth. Argue that there exists a steady state capital stock per efficiency unit of labor.
3. Graphically show the golden rule saving rate and explain what, if anything, a country that is below it should do.

Exercises

1. Suppose that you have a standard Solow model with a Cobb-Douglas production function and both labor augmenting productivity growth and population growth. The central equation of the model is:

$$\widehat{k}_{t+1} = \frac{1}{(1+z)(1+n)} [sA\widehat{k}_t^\alpha + (1-\delta)\widehat{k}_t].$$

- (a) Suppose that the economy initially sits in a steady state. Suppose that at time t there is a surprise increase in z that is expected to last forever. Use the main diagram to show how this will impact the steady state capital stock per efficiency unit of labor.
- (b) Plot out a diagram showing how the capital stock per efficiency unit of labor ought to react dynamically to the surprise increase in z .
- (c) Plot out diagrams showing how consumption and output per efficiency unit of labor will react in a dynamic sense to the surprise increase in z .
- (d) Do you think agents in the model are better off or worse off with a higher z ? How does your answer square with what happens to the steady state values of capital, output, and consumption per efficiency unit of labor? How can you reconcile these findings with one another?
2. Suppose that you have a standard Solow model with a Cobb-Douglas production function and both labor augmenting productivity growth and population growth. The central equation of the model is:

$$\widehat{k}_{t+1} = \frac{1}{(1+z)(1+n)} [sA\widehat{k}_t^\alpha + (1-\delta)\widehat{k}_t]$$

Consumption per efficiency unit of labor is:

$$\widehat{c}_t = (1-s)A\widehat{k}_t^\alpha.$$

- (a) Derive an expression for the steady state capital stock per efficiency unit of labor.
- (b) Use your answer from the previous part to derive an expression for the steady state value of consumption per effective worker.
- (c) Use calculus to derive an expression for the value of s which maximizes steady state consumption per worker. Does the expression for this s depend at all on the values of z or n ?
3. **[Excel Problem]** Suppose that you have the standard Solow model with both labor augmenting productivity growth and population growth. The production function is Cobb-Douglas. The central equation of the Solow model, expressed in per efficiency units of labor, is given by:

$$\widehat{k}_{t+1} = \frac{1}{(1+z)(1+n)} [sA\widehat{k}_t^\alpha + (1-\delta)\widehat{k}_t].$$

The other variables of the model are governed by Equations (6.23)–(6.27).

- (a) Create an Excel file. Suppose that the level of productivity is fixed at $A = 1$. Suppose that $s = 0.2$ and $\delta = 0.1$. Suppose that $\alpha = 1/3$. Let $z = 0.02$ and $n = 0.01$. Solve for a numeric value of the steady state capital stock per efficiency unit of labor.
- (b) Suppose that the capital stock per worker initially sits in period 1 in steady state. Create a column of periods, ranging from period 1 to period 100. Use the central equation of the model to get the value of \widehat{k} in period 2, given that \widehat{k} is equal to its steady state in period 1. Continue to iterate on this, finding values of \widehat{k} in successive periods up through period 9. What is true about the capital stock per efficiency unit of labor in periods 2 through 9?
- (c) In period 10, suppose that there is an increase in the population growth rate, from $n = 0.01$ to $n = 0.02$. Note that the capital stock per efficiency unit of labor in period 10 depends on variables from period 9 (i.e. the old, smaller value of n), though it will depend on the new value of n in period 11 and on. Use this new value of n , the existing value of the capital stock per efficiency unit of labor you found for period 9, and the central equation of the model to compute values of the capital stock per efficiency unit of labor in periods 10 through 100. Produce a plot showing the path of the capital stock per efficiency unit of labor from period 1 to period 100.
- (d) Assume that the initial levels of N and Z in period 1 are both 1. This means that subsequent levels of Z and N are governed by Equations (6.7) and (6.9). Create columns in your Excel sheet to measure the levels of N and Z in periods 1 through 100.
- (e) Use these levels of Z and N , and the series for \widehat{k} you created above, to create a series of the capital stock per work, i.e. $k_t = \widehat{k}_t Z_t$. Take the natural log of the resulting series, and plot it across time.
- (f) How does the increase in the population growth rate affect the dynamic path of the capital stock per worker?

Chapter 7

Understanding Cross-Country Income Differences

In Chapter 4, we documented that there are enormous differences in GDP per capita across country (see, e.g., Table 4.1). In this Chapter, we seek to understand what can account for these large differences. Our conclusion will be that, for the most part, poor countries are poor not because they lack capital, but because they are relatively unproductive. The fact that they are unproductive means that they have relatively little capital, but this lack of capital is a symptom of their lack of productivity, not the cause of their being poor. There is an analog to our work in the previous chapters (Chapters 5 and 6). To account for the time series stylized facts, the Solow model requires sustained increases in productivity over time. To account for large disparities of standards of living in a cross-sectional sense, the model requires large differences in productivity across countries. Productivity is the key driving force in the Solow model.

For this section we will be focusing on the basic Solow model from Chapter 5 without productivity or population growth. We could use the extended machinery of the augmented Solow model from 6, but this would not really alter the conclusions which follow. We will illustrate the arguments by assuming that there are just two countries, although it would be straightforward to include more than two.

Suppose that we have two countries, which we will label with a 1 and a 2 subscript, i.e. country 1's capital per capita at time t will be represented by $k_{1,t}$. We assume that both countries have a Cobb-Douglas production function and that the parameter α is the same across countries. We also assume that capital depreciates at the same rate in both countries. We will potentially allow three things to differ across the two countries – productivity levels (i.e. $A_1 \neq A_2$, though we again drop subscripts and hence implicitly assume that these variables are constant going forward in time), saving rates (i.e. $s_1 \neq s_2$), and *initial* endowments of capital per worker (i.e. $k_{1,t} \neq k_{2,t}$).

At any point in time, output per capita in the two countries is:

$$y_{1,t} = A_1 k_{1,t}^\alpha \quad (7.1)$$

$$y_{2,t} = A_2 k_{2,t}^\alpha \quad (7.2)$$

The ratio of output per capita in the two countries is:

$$\frac{y_{1,t}}{y_{2,t}} = \frac{A_1}{A_2} \left(\frac{k_{1,t}}{k_{2,t}} \right)^\alpha \quad (7.3)$$

From (7.3), we can see that there are really only two reasons why the countries could have different levels of output per capita – either the productivity levels are different or the capital stocks per capita are different. Which one is it, and what are the policy implications?

7.1 Convergence

Let us suppose, for the moment, that countries 1 and 2 are fundamentally the same, by which we mean that they have the same productivity levels and the same saving rates. This means that the only thing that could potentially differ between the two countries is the initial endowment of capital stocks per worker.

As you might recall from Chapter 5, the steady state capital stock per worker, and hence the steady state level of output per worker, does not depend on the initial endowment of capital. Starting from any (non-zero) initial endowment of capital, the economy converges to a steady state where the steady state is determined by productivity, the saving rate, the curvature of the production function, and the depreciation rate. If we are supposing that all of the features are the same for the two countries under consideration, it means that these countries will have the *same* steady state capital stocks per worker and hence *identical* steady state levels of output per capita.

Will these two countries always have the same output per worker? Not necessarily – this will only be true in the steady state. One hypothesis for why some countries are richer than others is that those countries are initially endowed with more capital than others. Suppose that this is the case for countries 1 and 2. Let country 1 be relatively rich and country 2 relatively poor, but the countries have identical productivity levels and saving rates. Figure 7.1 below plots the main Solow diagram, with one twist. We index the countries by $j = 1, 2$. Since the countries have identical parameters, the main equation of the Solow model is the same for both countries, so $k_{j,t+1} = sAf(k_{j,t}) + (1 - \delta)k_{j,t}$. Suppose that country 1 starts out in period t with a capital stock equal to the steady state capital stock, so $k_{1,t} = k^*$. Country 2 starts out with an initial capital stock substantially below that, $k_{2,t} < k^*$. In this scenario,

country 2 is poor because it is initially endowed with little capital.

Because country 2 is initially endowed with less capital than country 1, it will initially produce less output than country 1. But because country 2 starts out below its steady state capital stock, its capital will grow over time, whereas the capital stock for country 1 will be constant. This means that, if country 2 is poor relative to country 1 only because it is initially endowed with less capital than country 1, it will grow faster and will eventually catching up to country 1 (since the steady state capital stocks are the same).

Figure 7.1: Country 1 Initially Endowed With More Capital than Country 2

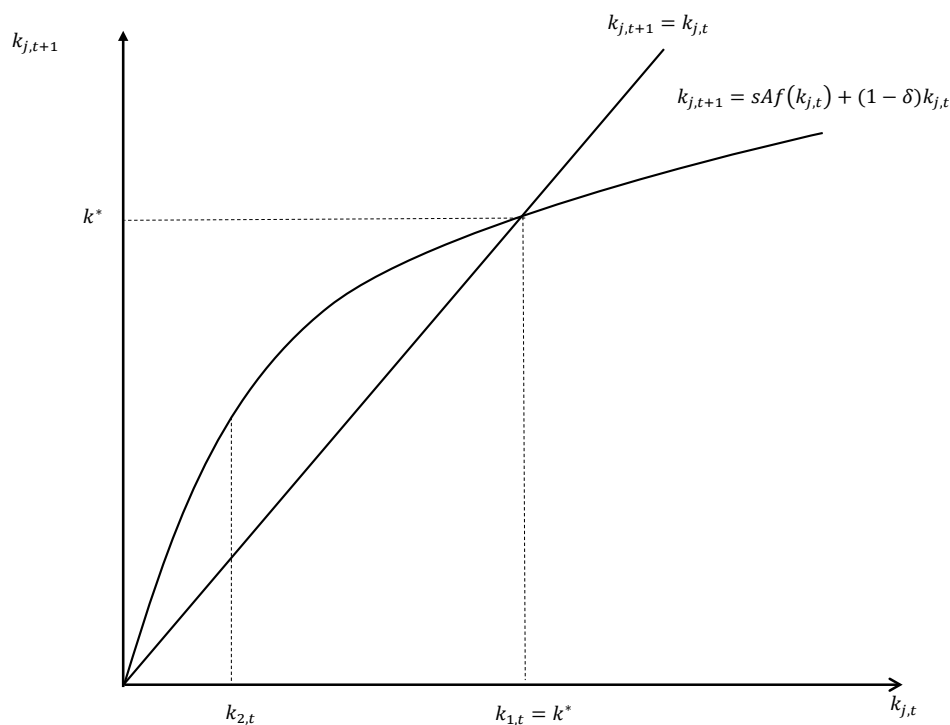

Figure 7.2 plots in the left panel the dynamic paths of the capital stock in each country from the assumed initial starting positions – i.e. it plots $k_{j,t+s}$ for $j = 1, 2$ and $s \geq 0$. Since it starts in steady state, country 1’s capital stock per worker simply remains constant across time. Country 2 starts with a capital stock below steady state, but its capital stock should grow over time, eventually catching up to country 1. In the right panel, we plot the growth rate of output per worker in each country across time, $g_{j,t+s}^y$. Because it starts in steady state, country 1’s growth rate will simply remain constant at zero (more generally, if there were population or productivity growth, country 1’s output growth would be constant, just not necessarily zero). In contrast, country 2 will start out with a high growth rate – this is because it is accumulating capital over time, which causes its output to grow faster than

country 1. Eventually, country 2's growth rate should settle down to 0, in line with country 1's growth rate.

This analysis suggests that the Solow model predicts *convergence* if two countries have the same saving rates and same levels of productivity. In other words, if one country is relatively poor because it is initially endowed with less capital than another country, that country should grow faster than the other country, eventually catching up to it. Casual observation suggests that convergence is likely not consistent with the data – there are very large and very persistent differences in GDP per capita across countries. If countries only differed in their initial endowment of capital, countries should eventually all look the same, and we don't seem to see that.

Figure 7.2: Paths of Capital and Output Growth for Countries 1 and 2

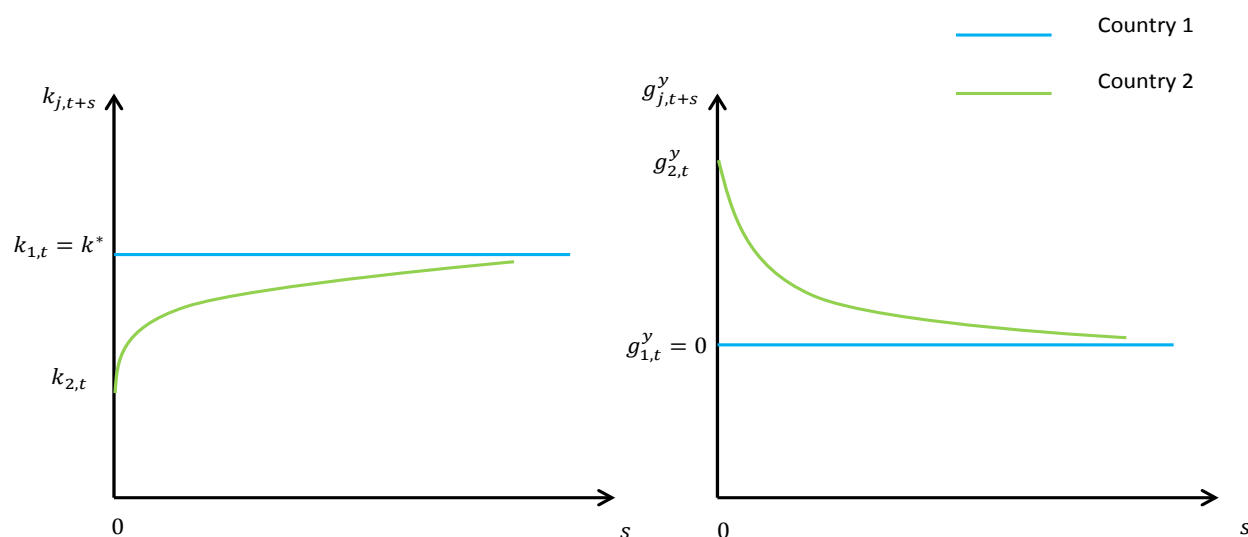
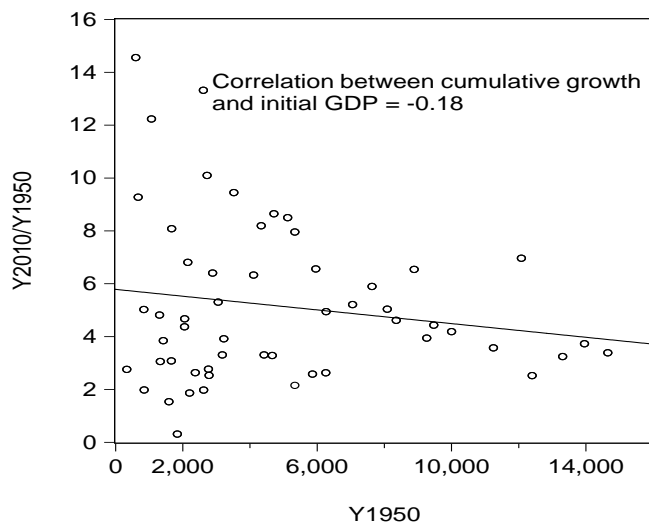

Figure 7.3 plots a scatter plot of 1950 GDP per capita (measured in real US dollars) and the cumulative gross growth rate of GDP from 1950-2010 for a handful of countries. The vertical axis measures the ratio of a country's GDP per capita in 2010 to its GDP per capita in 1950; this ratio can be interpreted as the gross growth rate over that sixty year period. The horizontal axis is the GDP per capita level in 1950. If countries which were poor in 1950 were poor because of a lack of capital to rich countries, these countries should have experienced faster growth over the ensuing 60 years.

Figure 7.3: Initial GDP Per Capita in 1950 and Cumulative Growth From 1950–2010



Is the evidence consistent with the data? In a sense yes, though the data do not provide very strong support for the convergence hypothesis. The convergence hypothesis makes the prediction that ensuing growth rates should be negatively correlated with initial GDP per capita. We do see some evidence of this, but it's fairly weak. The correlation between cumulative growth over the 60 year period and initial GDP is only -0.13. There are some countries which were very poor in 1950 but experienced very rapid growth (represented by dots near the upper left corner of the graph). This pattern is loosely consistent with the convergence hypothesis. But there are many countries that were very poor in 1950 yet still experienced comparatively low growth over the ensuing sixty years (these countries are represented by dots near the origin of the graph).

The countries included in the scatter plot shown in Figure 7.3 include all countries for which data are available dating back to 1950. Would the picture look different if we were to focus on a subset of countries that are potentially more similar to one another? In Figure 7.4, we reproduce a scatter plot between cumulative growth over the last 60 years and the initial level of real GDP, but focus on countries included in the OECD, which stands for Organization for Economic Cooperation and Development. These include primarily western developed economies that trade extensively with one another.

Figure 7.4: Initial GDP Per Capita in 1950 and Cumulative Growth From 1950–2010
OECD Countries

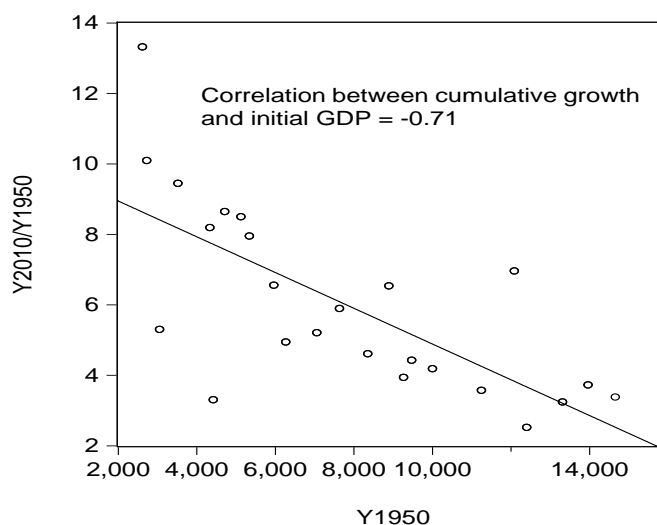

Relative to Figure 7.3, in Figure 7.4, we observe a much stronger negative relationship between the initial level of real GDP and subsequent growth. The correlation between initial GDP and cumulative growth over the ensuing 60 years comes out to be -0.71 , which is substantially stronger than when focusing on all countries.

What are we to conclude from Figures 7.3 and 7.4? While there is some evidence to support convergence, particularly for a restricted set of countries that are fairly similar, overall the convergence hypothesis is not a great candidate for understanding some of the extremely large differences in GDP per capita which we observe in the data.

7.1.1 Conditional Convergence

To the extent to which the Solow model provides a reasonably accurate description of actual economies, the evidence above suggests that convergence doesn't seem to be a very strong feature of the data – countries have different levels of GDP per capita and these differences seem to persist over time. This either suggests that the Solow model is fundamentally wrong on one or more levels or that it is a reasonable description of reality but something other than initial endowments of capital is the primary reason behind differences in standards of living across countries.

What about a weaker proposition than absolute convergence, something that we will call *conditional convergence*? Conditional convergence allows for countries to have different values of s or A , but still assumes that the economies of these countries are well approximated by the Solow model. Allowing these countries to have different s or A means that their steady

states will be different. The model would predict that if an economy begins with less capital than its steady state, it ought to grow faster to catch up to its steady state (though that steady state might be different than another country's steady state).

World War II provides a clean natural test of conditional convergence. Let's focus on four countries – two of which were the primary winners of the war (the U.S. and United Kingdom) and two of which were the main losers of the war (Germany and Japan).¹ Figure 7.5 plots the relative GDP per capita of these countries over time (relative to the U.S.). This is over the period 1950–2010. By construction, the plot for the U.S. is just a straight line at 1. The UK plot is fairly flat, with UK GDP about two-thirds (0.66) of U.S. GDP over most of the sample period.

Figure 7.5: Real GDP Per Capita Relative to the United States

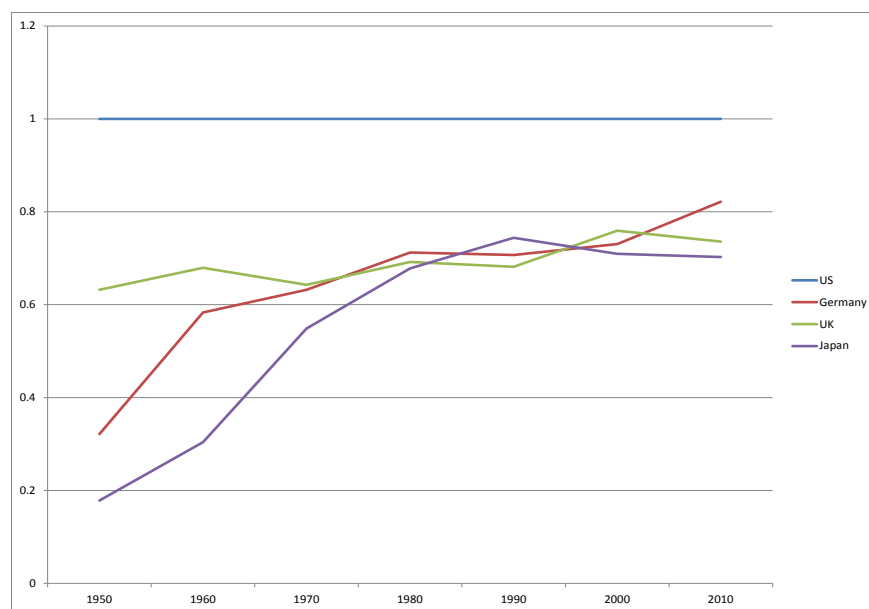

The plots for Germany and Japan look quite different. These countries both started quite poor relative to the U.S. in 1950 (immediately after the War), but grew significantly faster than the US over the ensuing 20–30 years. In particular, from 1950–1980, Germany went from GDP per capita about one-third the size of the U.S.'s to GDP per capita about 70 percent as big as the U.S.. Japan went from GDP per capita less than 20 percent of the U.S.'s in 1950 to GDP per capita about 75 percent of the U.S.'s in 1980. After 1980, the GDP per capita of both German and Japan has been roughly stable relative to U.S. GDP per capita.

The patterns evident in Figure 7.5 are consistent with the Solow model once you allow countries to differ in terms of their saving rates or their levels of productivity. One can

¹We do not have good data for Russia because the collapse of the Soviet Union.

think about World War II as destroying a significant amount of capital in both Japan and Germany (while the U.S. was unaffected and the UK was affected, but to a lesser degree). Effectively, we can think about the U.S. and the UK as being close their steady state capital stocks in 1950, whereas Germany and Japan were far below their steady state capital stocks. The Solow model would predict that Germany and Japan ought to have then grown faster relative to the U.S. and the UK for several years as they converged to their steady states. This is exactly what we observe in the data. This convergence seems to have taken roughly 30 years, but seems to have stopped since then. These findings are significant, because they are consistent with the Solow model being an accurate description of reality, but point to countries differing in fundamental ways other than just initial endowments of capital.

7.2 Can Differences in s Account for Large Per Capita Output Differences?

Given that absolute convergence seems to be a poor description of the data, within the context of the Solow model it must be the case that income per capita differences across economies stem from fundamental differences in productive capacities or saving rates.

Consider the standard Solow model with a Cobb-Douglas production function. Assume that two countries have the same α and same δ , but potentially differ in terms of saving rates and productivity levels (where we assume that the productivity levels in each country have settled down to constants). Under these assumptions, the steady state output per worker in country $j = 1, 2$ is given by:

$$y_j^* = A_j^{\frac{1}{1-\alpha}} \left(\frac{s_j}{\delta} \right)^{\frac{\alpha}{1-\alpha}} \quad \text{for } j = 1, 2 \quad (7.4)$$

The ratio of steady state output per capita across the two economies is then:

$$\frac{y_1^*}{y_2^*} = \left(\frac{A_1}{A_2} \right)^{\frac{1}{1-\alpha}} \left(\frac{s_1}{s_2} \right)^{\frac{\alpha}{1-\alpha}} \quad (7.5)$$

Very persistent differences in output per capita across the two countries (by which we mean different steady state levels of output) can be driven either by differing productivity levels (i.e. $A_1 \neq A_2$) or different saving rates (i.e. $s_1 \neq s_2$).

In this section we wish to pose the following question: can differences in s alone account for large and persistent differences in output per capita? Here we will not focus on any data but will instead simply conduct what one might call a plausibility test. In particular, can plausible differences in s account for large differences in steady state output per capita? The answer turns out to be no for plausible values of α .

To see this concretely, suppose that the two countries in question have the same level of productivity, i.e. $A_1 = A_2$. From (7.5), their relative outputs are then:

$$\frac{y_1^*}{y_2^*} = \left(\frac{s_1}{s_2} \right)^{\frac{\alpha}{1-\alpha}}. \quad (7.6)$$

Our objective is to see how different saving rates across countries would have to be to account for a given difference in per capita output. Let's consider a comparison between a "middle income" country like Mexico and the U.S.. As one can see from Table 4.1, Mexican output per capita is about one-fourth the size of the U.S.. Suppose that country 1 is the U.S., and country 2 is Mexico. Then $\frac{y_1^*}{y_2^*} = 4$. Let's then solve (7.6) for s_2 in terms of s_1 , given this income difference. We obtain:

$$s_2 = 4^{\frac{\alpha-1}{\alpha}} s_1. \quad (7.7)$$

A plausible value of α is $1/3$. With this value of α , $4^{\frac{\alpha-1}{\alpha}} = 0.0625$. What Equation (7.7) then tells us is that, to account for Mexican GDP that is one-fourth of the U.S.'s, the Mexican saving rate would have to be 0.0625 times the U.S. saving rate – i.e. the Mexican saving rate would have to be about 6 percent of the US saving rate. If the U.S. saving rate is $s_1 = 0.2$, this would then mean that the Mexican saving rate would have to be $s_2 = 0.0125$. This means that Mexico would essentially have to be saving nothing if the only thing that differed between Mexico and the U.S. was the saving rate. This is not plausible.

The results are even less plausible if one compares a very poor country to the U.S.. Take, for example, Cambodia. U.S. GDP per capita is about 20 times larger than that in Cambodia. If the U.S. saving rate were $s_1 = 0.2$, then the Cambodian saving rate would have to be $s_2 = 0.0025$ – i.e. essentially zero. One could argue that extremely poor countries are caught in a sort of poverty trap wherein they have not reached what one might call a subsistence level of consumption, and therefore actually do not save anything. This could be an explanation for extremely poor countries, such as those in Africa. But it is not a compelling argument for middle income countries like Mexico.

Note that the assumed value of α has an important role in these plausibility tests. When $\alpha = 1/3$, the exponent $(\alpha - 1)/\alpha$ in (7.7) is -2 . If α were instead $2/3$, however, the exponent would be $-1/2$. With this value of α , taking the Mexican versus U.S. comparison as an example, one would only need the Mexican saving rate to be about $1/2$ as big as the U.S. (as opposed to 6 percent of the U.S. saving rate when $\alpha = 1/3$). This is far more plausible.

Mankiw, Romer, and Weil (1992) empirically examine the relationship between saving rates and output per capita across a large set of countries. They find that saving rates are much more strongly correlated with GDP per capita across countries than the standard Solow

model with a relatively low value of α (e.g. $\alpha = 1/3$) would predict. Their empirical analysis points to a value of α more on the order of $\alpha = 2/3$. They argue that the basic Solow model production function is misspecified in the sense that human capital, which we discussed in Chapter 4, ought to be included. Roughly speaking, they find that physical capital, human capital, and labor input ought to each have exponents around $1/3$. Human capital ends up looking very much like physical capital in their model, and in a reduced-form sense implies a weight on physical capital in a misspecified production function on the order of $2/3$. With this, the Solow model predicts a much stronger relationship between saving rates and output per capita that allows for more plausible differences in saving rates to account for large the differences in output per capita that we observe in the data.

7.3 The Role of Productivity

For a conventionally specified Solow model, differences in saving rates cannot plausibly account for the very large differences in GDP per capita which we observe across countries in the data. While the inclusion of human capital in the model can help, it still cannot explain all of the observable income differences.

To the extent to which we believe the Solow model, this leaves differences in productivity – i.e. different levels of A across countries – as the best hope to account for large differences in standards of living across countries. In a sense, this result is similar to our conclusion in Chapters 5 and 6 that productivity must be the primary driver of long run growth, not saving rates.

This begs the question – are there are large differences in productivity across countries? We can come up with empirical measures of A across countries by assuming a function form for the production function. In particular, suppose that the production function is Cobb-Douglas:

$$Y_t = AK_t^\alpha N_t^{1-\alpha}. \quad (7.8)$$

Take natural logs of (7.8) and re-arrange terms to yield:

$$\ln A = \ln Y_t - \alpha \ln K_t - (1 - \alpha) \ln N_t. \quad (7.9)$$

If we can observe empirical measures of Y_t , K_t , and N_t across countries, and if we are willing to take a stand on a value of α , we can recover an empirical estimate of $\ln A$. In essence, $\ln A$ is a residual – it is the part of output which cannot be explained by observable capital and labor inputs. Consequently, this measure of $\ln A$ is sometimes called the “Solow residual.” It is also called “total factor productivity” (or TFP for short).

The [Penn World Tables](#) provide measures of TFP for countries at a point in time. From there we can also collect data on GDP per worker or per capita. Figure 7.6 present a scatter plot of GDP per worker (measured in 2011 U.S. dollars) against TFP (measured relative to the U.S., where U.S. TFP is normalized to 1) for the year 2011. Each circle represents a TFP-GDP pair for a country. The solid line is the best-fitting regression line through the circles.

We observe that there is an extremely tight relationship between TFP and GDP per capita. In particular, the correlation between the two series is 0.82. By and large, rich countries (countries with high GDP per worker) have high TFP (i.e. are very productive) and poor countries have low TFP (i.e. are not very productive).

Figure 7.6: Scatter Plot: TFP and GDP Per Worker in 2011

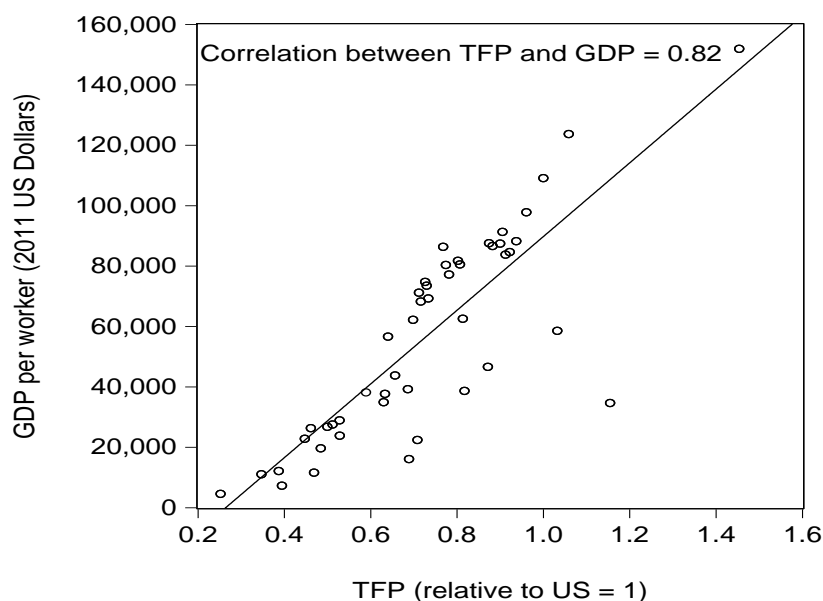

In summary, the Solow model suggests that the best explanation for large differences in standards of living is that there are large differences in productivity across countries. If some countries were poor simply because they were initially endowed without much capital, the Solow model would predict that these countries would converge to the GDP per capita of richer countries. For the most part, we do not see this in the data. For plausible values of α , the differences in saving rates which would be needed to justify the large differences in GDP per capita observed in the data would be implausible. This leaves differences in productivity as the best candidate (within the context of the Solow model) to account for large differences in standards of living. Empirically, this seems to be consistent with the data, as is documented in Figure 7.6 – rich countries tend to be highly productive and poor countries tend to be very unproductive.

This conclusion begs the question: what exactly is productivity (measured in the model in terms of the variable A)? The model takes this variable to be exogenous (i.e. does not seek to explain it). For many years, economists have sought to better understand what drives this productivity variable. Understanding what drives differences in productivity is important for thinking about policy. By and large, countries are not poor because they lack capital or do not save enough – they are poor because they are unproductive. This means that policies which give these countries capital or try to increase their saving rates are not likely to deliver large changes in GDP per capita. Policies to lift these countries out of poverty need to focus on making these countries more productive.

Below is a partial listing (with brief descriptions) of different factors which economists believe contribute to overall productivity:

1. **Knowledge and education.** A more educated workforce is likely to coincide with a more productive workforce. With more knowledge, workers can better make use of existing physical capital and can come up with new and better ways to use other inputs. As documented in Chapter 4, there is a strong positive correlation between an index of human capital (which one can think of as measuring the stock of knowledge in an economy) and real GDP per person. Related to this, [Cubas, Ravikumar, and Ventura \(2016\)](#) present evidence that the quality of labor in rich countries is nearly as twice as large as in most poorer countries.
2. **Climate.** An interesting empirical fact is this: countries located in climates closer to the Equator (think countries like Mexico, Honduras, and many African countries) tend to be poor relative to countries located further from the equator (think the U.S., northern Europe, and Australia). Hot, muggy climates make it difficult for people to focus and therefore are associated with lower productivity. These climates are also ones where disease tends to thrive, which also reduces productivity. As an interesting aside, there is suggestive evidence that the economic development in the southern states of the U.S. was fueled by the rise of air conditioning in the early and middle parts of the 20th century.
3. **Geography.** From microeconomics, we know that trade leads to specialization, which leads to productivity gains. How much trade a country can do is partly a function of its geography. A country with many natural waterways, for example, makes the transport of goods and services easier, and results in specialization. Think about the many waterways in the U.S. (like the Mississippi River) or the Nile River in Egypt. Geographies with very mountainous and difficult to cross terrain, like Afghanistan, are not well suited for trade and the gains from specialization associated with it.

4. **Institutions.** Economists increasingly point to “institutions,” broadly defined, as an important contributor to productivity. By institutions we primarily mean things like legal tradition, the rule of law, etc.. Countries with good legal systems tend to be more productive. When there are well-defined and protected property rights, innovation is encouraged, as innovators will have legal claims to the fruits of their innovation. In countries with poor legal protections (think undeveloped Africa, countries like Afghanistan, etc.), there is little incentive to innovate, because an innovator cannot reap the rewards of his or her innovations. [Acemoglu, Johnson, and Robinson \(2001\)](#) have pointed to colonial development with European-style legal traditions in countries like the U.S. and Australia as important factors in the quality institutions of these countries now, and consequently their relatively high productivity.
5. **Finance.** The financial system intermediates between savers and borrowers, and allows for the implementation of large scale projects which individuals or businesses would not be able to do on their own because of a lack of current funds. Relatively rich countries tend to have good financial institutions, which facilitates innovation. Poorer countries do not have well-developed financial institutions. A lot of recent research in development economics concerns the use of better finance to help fuel productivity.
6. **Free trade.** Countries with fewer barriers to international trade tend to have higher productivity. International trade in goods and services has two effects. First, like trade within a domestic economy, it allows for greater specialization. Second, trade in goods and services leads to knowledge spillovers from rich to poor countries, increasing the productivity levels in poor countries. [Sachs and Warner \(1995\)](#) document that relatively open economies grow significantly faster than relatively closed economies.
7. **Physical infrastructure.** Countries with good physical infrastructure (roads, bridges, railways, airports) tend to be more productive than countries with poor infrastructure. Good physical infrastructure facilitates the free flow of goods, services, and people, resulting in productivity gains.

If productivity is the key to high standards of living, policies should be designed to foster higher productivity. Climate and geography are things which are largely beyond the purview of policymakers (although one could argue that Global Warming is something which might harm future productivity and should therefore be addressed in the present). Policies which promote good legal and political institutions, free trade, good and fair financial systems, and solid physical infrastructure are good steps governments can take to increase productivity.

7.4 Summary

- In the steady state, income differences across countries are driven by differences in saving rates and productivity levels, but not initial levels of capital. Outside of steady state however, a country's income and growth rate are in part determined by their initial capital stocks.
- The Solow model predicts that if countries share common saving rates and productivity levels, they will converge to the same steady state level of output per worker. This is called the convergence hypothesis. Analysis of data over the last 60 years suggests that countries by and large fail to converge meaning that there must be differences in either cross country saving rates or productivity levels.
- The conditional convergence hypothesis allows countries to have different levels of productivity and saving rates but still assumes that their economies are well approximated by the Solow model. There is rather strong evidence of conditional convergence in the data. Countries which had large portions of their capital stocks destroyed in WWII subsequently grew faster than other rich countries.
- For typical values of α , differences in saving rates alone cannot plausibly explain long-run differences in income across countries. However, if the production function is mis-specified by omitting intangible forms of capital like human capital, the combined values of the capital shares may be much bigger which would allow for saving rates to play a bigger role in cross country income determination.
- If differences in saving rates cannot explain cross country income differences that leaves differences in TFP as the main driver of income disparities. Indeed, a country's GDP per worker is strongly correlated with its TFP level.
- Although productivity is exogenous to the Solow model, some variables that might determine a country's TFP include: climate, geography, education of its citizens, access to trade, the financial system, legal institutions, and infrastructure.

Questions for Review

1. Explain, in words, what is meant by the convergence hypothesis. What feature of the Solow model gives rise to the prediction of convergence?
2. Explain what is meant by conditional convergence. Can you describe an historical event where conditional convergence seems to be at work?

3. Try to provide some intuition for why differences in saving rates cannot plausibly account for large differences in income per capita for relatively low values of α . Hint: it has to do with how α governs the degree of diminishing returns to capital.
4. Discuss several factors which might influence a country's level of productivity.
5. Suppose that you were a policy maker interested in increasing the standard of living in a poor African country. Suppose that an aide came to you and suggested giving every resident of that country a laptop computer. Do you think this would be a good idea? If not, propose an alternative policy to help raise the standard of living in the poor African country.
6. Do you think that any of the lessons from the Solow model about understanding large cross-country differences in income could be applied to understanding income differences *within* a country? If so, how? Elaborate.

Exercises

1. **[Excel Problem]** Suppose that you have two countries, call them 1 and 2. Each is governed by the Solow model with a Cobb-Douglas production function, but each each country has potentially different values of s and A . Assume that the value of A for each country is fixed across time. The central equation of the model is:

$$k_{i,t+1} = s_i A_i k_{i,t}^\alpha + (1 - \delta)k_{i,t}, \quad i = 1, 2.$$

Output in each country is given by:

$$y_{i,t} = A_i k_{i,t}^\alpha.$$

- (a) Solve for the steady state capital stock per worker for generic country i (i is an index equal to either 1 or 2).
- (b) Use this to solve for the steady state level of output per worker in country i .
- (c) Use your answers from previous parts to write an expression for the ratio of steady state output in country 1 to country 2 as a function of the respective saving rates, productivity levels, and common parameters of the model.
- (d) Suppose that each country has the same value of A , so $A_1 = A_2$. Suppose that $\alpha = 1/3$, and $\delta = 0.1$. Suppose that the saving

rate in country 1 is $s_1 = 0.2$. In an Excel spreadsheet, compute different values of the relative steady state outputs (i.e. $\frac{y_1^*}{y_2^*}$) ranging from 1 to 5, with a gap of 0.1 between entries (i.e. you should create a column with 1, 1.01, 1.02, 1.03, and so on). For each value of $\frac{y_1^*}{y_2^*}$, solve for the value of s_2 necessary to be consistent with this. Produce a graph of this value of s_2 against the values of $\frac{y_1^*}{y_2^*}$. Comment on whether it is plausible that differences in saving rates could account for large differences in relative GDPs.

- (e) Redo this exercise, but instead assume that $\alpha = 2/3$. Compare the figures to one another. Comment on how a higher value of α does or does not increase the plausibility that differences in saving rates can account for large differences in output per capita.

2. **Excel Problem.** Suppose that you have many countries, indexed by i , who are identical in all margins except they have different levels of A , which are assumed constant across time but which differ across countries. We denote these levels of productivity by A_i . The central equation governing the dynamics of capital in a country i is given by:

$$k_{i,t+1} = sA_i k_{i,t}^\alpha + (1 - \delta)k_{i,t}$$

Output in each country is given by:

$$y_{i,t} = A_i k_{i,t}^\alpha$$

- (a) Solve for expressions for steady state capital and output in a particular country i as functions of its A_i and other parameters.
- (b) Create an Excel sheet. Create a column with different values of A , each corresponding to a different level of productivity in a different country. Have these values of A_i run from 0.1 to 1, with a gap of 0.01 between entries (i.e. create a column going from 0.1, 0.11, 0.12, and so on to 1). For each level of A_i , numerically solve for steady state output. Create a scatter plot of steady state output against A_i . How does your scatter plot compare to what we presented for the data, shown in Figure

7.6?

Chapter 8

Overlapping Generations

In Chapters 5 and 6 we explored the Solow model which is a model designed to think about economic performance in the long run. A disadvantage of the Solow model is that the saving decision on the part of the representative household is exogenously given and not derived from an underlying economic decision-making problem. Further, without a description of preferences, it is difficult to say much about *normative* implications of the model as they relate to policy. Finally, because the model is populated by one representative household that lives forever, it is not possible to address issues related to intergenerational transfers (i.e. things like Social Security systems, which are in effect transfers from young people to old).

In this Chapter we consider what is called an Overlapping Generations (OLG) model. The OLG model was first developed by Samuelson (1958) and Diamond (1965). Like the Solow model, time runs forever. But in the OLG model, we depart from the infinitely-lived representative agent assumption. A representative agent is replaced by agents that live two periods. In the first period agents are “young” and in the second they are “old.” At the end of each period, all old agents die, the young transition to old, and a new cohort of young agents is born. In their youth, agents optimally choose saving so as to maximize the present discounted value of lifetime utility. In other words, the saving decision of a household is explicitly endogenized in a way that it is not in the Solow model. Nevertheless, the OLG model is in many ways similar to the Solow model. But because of explicit optimization on the part of households, as well as multiple generations alive at any one point in time, we are able to address some of the issues raised in the opening paragraph.

In many respects this chapter provides a bridge from Part II to Part III. In particular, the set of issues it addresses are most closely connected to the material in Part II but it makes use of tools and analysis that are more similar to Part III.

8.1 The General Overlapping Generations Model

Time will be denoted with the usual subscripts – think of t as the present, $t + 1$ as one period into the future, $t - 1$ as one period in the past, and so on. At any given time, there are two types of agents alive – young and old. Each household (which we use interchangeably

with “agent”) lives two periods. In the first period a household is “young” and in the second it is “old.” At the end of a period, the old agents die and a new cohort of young agents are born. Let the number of young agents born in a given period be N_t . The total number of agents alive in any period is $N_t + N_{t-1}$, where N_{t-1} denotes the number of old households alive in t (equal to the number of young households born in $t - 1$). We assume that the number of agents born each period evolves exogenously; $N_t > N_{t-1}$ would mean that more and more young households are born each period, so the total population would be growing. We must keep track of both time and generation. As such, we will index variables chosen by agents with a y or o subscript, for “young” or “old.”

Aside from the two types of households, the economy is populated by a single representative firm. This firm is similar to the representative firm in the Solow model. It simply leases factors of production and produces output. Differently than the Solow model, decisions about capital accumulation will be derived from an underlying microeconomic optimization problem.

8.1.1 Households

A household is born with no wealth. The key decision-making occurs in the first period of life. In its youth, a household supplies one unit of labor inelastically, for which it is compensated at real wage w_t . The key decision a young household must make is how much of its income to consume and how much to save. Let s_t denote the saving of a young household in period t (we will use lowercase letters to denote the quantities chosen by an individual household). Saving is turned into productive capital in the next period, which can be rented to the representative firm at rental rate R_{t+1} . The household can then consume any capital leftover after depreciation once production in $t + 1$ takes place, $(1 - \delta)s_t$, where $0 \leq \delta \leq 1$ is the depreciation rate on capital. Old households do not supply any labor (i.e. they are retired and live off the income from their accumulated capital).

Let s_t denote the saving of a young household and $c_{y,t}$ its consumption in period t . Since it supplies one unit of labor inelastically, the budget constraint it faces in period t is:

$$c_{y,t} + s_t \leq w_t \tag{8.1}$$

In old age, the household has income from renting capital and can consume any remaining capital after depreciation. Hence, the constraint facing an old household in $t + 1$ is:

$$c_{o,t+1} \leq [R_{t+1} + (1 - \delta)] s_t \tag{8.2}$$

From the perspective of period t , a household’s lifetime utility, U , is a weighted sum of

utility flows from consumption in each stage of life. Consumption is mapped into utility via some function $u(\cdot)$, which we assume is increasing ($u'(\cdot) > 0$) and concave ($u''(\cdot) < 0$). Future utility flows are discounted relative to current utility flows by $0 < \beta < 1$, where β is called a discount factor and measures a household's degree of impatience. Formally, lifetime utility is:

$$U = u(c_{y,t}) + \beta u(c_{o,t+1}) \quad (8.3)$$

A young household's objective is to pick s_t to maximize (8.3) subject to the two flow budget constraints, (8.1)-(8.2). As we will do later in the book (see, e.g., Part III), we can solve a constrained optimization problem by assuming that both constraints bind with equality and substituting them into the objective function. This turns the constrained problem into an unconstrained one. Doing so we get:

$$\max_{s_t} U = u(w_t - s_t) + \beta u([R_{t+1} + (1 - \delta)] s_t) \quad (8.4)$$

To characterize the optimum, take the derivative of (8.4) with respect to s_t and equate it to zero:

$$\frac{\partial U}{\partial s_t} = 0 \Leftrightarrow u'(w_t - s_t) = \beta [R_{t+1} + (1 - \delta)] u'([R_{t+1} + (1 - \delta)] s_t) \quad (8.5)$$

(8.5) can be written in a way that is somewhat easier to interpret by writing the arguments of the utility function in terms of consumption, or:

$$u'(c_{y,t}) = \beta [R_{t+1} + (1 - \delta)] u'(c_{o,t+1}) \quad (8.6)$$

(8.6) is very similar to the canonical consumption Euler equation which is studied in Chapter 9. The intuition for why (8.6) must hold is as follows. Suppose that a young household increases its saving by one unit. This reduces consumption during youth by 1, which lowers lifetime utility by $u'(c_{y,t})$. Hence, the left hand side of (8.6) may be interpreted as the marginal utility cost of saving more. What is the benefit? If the household saves one more unit in its youth, it can consume $R_{t+1} + (1 - \delta)$ additional units in its old age (the rental rate from leasing the capital to the representative firm plus any capital left over after depreciation). This extra consumption is valued at $\beta u'(c_{o,t+1})$. Hence, the right hand side of (8.6) represents the marginal utility benefit of saving more in youth. At an optimum, the marginal utility benefit must equal the marginal utility cost. Were this not so, e.g. the marginal utility benefit of saving exceeded the cost, the household should be saving more, and hence could not be optimizing.

Expression (8.5) implicitly determines an optimal level of saving, s_t , as a function of

factor prices, w_t and R_{t+1} . We denote this optimal level of saving via:

$$s_t = s(w_t, R_{t+1}) \quad (8.7)$$

Without specifying a functional form for $u(\cdot)$, we cannot say much specific about the (unknown) function $s(\cdot)$. We can conclude that it is increasing in w_t , i.e. $s_w(\cdot) > 0$. If w_t increases, it must be the case that s_t increases. If s_t did not change, the marginal utility cost of saving (the left hand side of (8.5)) would decrease but there would be no change in the marginal utility benefit. In contrast, if s_t decreased, the marginal utility cost of saving would decrease while the marginal utility benefit of saving (the right hand side of (8.5)) would increase. Since the marginal utility benefit must equal the marginal utility cost, an increase in w_t must be met by an increase in s_t . In contrast, it is not possible to say with certainty how R_{t+1} impacts optimal saving. On the one hand, a higher R_{t+1} works to increase the marginal utility benefit of saving by increasing the extra consumption a household may enjoy in its old age; but on the other hand, for a fixed level of s_t a higher R_{t+1} reduces the way in which this extra consumption is valued (i.e. for a given s_t a higher R_{t+1} makes $u'([R_{t+1} + (1 - \delta)]s_t)$ smaller given the concavity of $u(\cdot)$). Hence, we cannot say with certainty how R_{t+1} impacts desired saving.¹

8.1.2 Firm

As in the Solow model, there is a single, representative firm (or many identical firms, the total size of which may be normalized to one). Output is produced using capital and labor according to the same sort of production function we previously encountered. Formally:

$$Y_t = A_t F(K_t, N_t) \quad (8.8)$$

Note that we are here using capital letters, whereas when describing the problem of a particular household we used lower case letters. This is because there is a single representative firm, and Y_t therefore denotes *aggregate* output produced within a period. K_t is the aggregate stock of capital owned by old households in period t and leased to the firm, while N_t is the

¹Formally, as we discuss in more depth in Chapter 9, there are both income and substitution effects associated with changes in R_{t+1} . A higher R_{t+1} makes current consumption expensive relative to consumption in old age, which works to make saving higher. This is what is called a substitution effect. On the other hand, since a household must do some positive saving in its youth to allow it to consume in its old age, a higher R_{t+1} also effectively endows the household with more income in the future, which makes it want to consume more in the present. This is what is called an income effect. Since the income and substitution effects go in opposite directions, it is not possible in general to determine how R_{t+1} impacts saving. When w_t changes, in contrast, there is only a positive income effect which makes the household desire to consume more both in its youth as well as old age, the latter of which necessitates saving more while young.

total number of young households, each of whom supply unit of labor inelastically. $F(\cdot)$ is an increasing and concave function with constant returns to scale; these are exactly the same assumptions made for the Solow model. A_t is an exogenous productivity variable. While it is exogenous and can hence change, we will not consider differences between its value in t and subsequent periods (i.e. if we consider any change in A_t it will be *permanent*). Hence, for notational ease we shall henceforth drop the t subscript on A .

The firm is a price-taker and chooses K_t and N_t to maximize its profit each period. The problem is static and the same each period. It is:

$$\max_{K_t, N_t} \Pi_t = AF(K_t, N_t) - w_t N_t - R_t K_t \quad (8.9)$$

As previously encountered in the Solow model, the optimality conditions are to equate marginal products to factor prices:

$$AF_K(K_t, N_t) = R_t \quad (8.10)$$

$$AF_N(K_t, N_t) = w_t \quad (8.11)$$

Because of the assumption of constant returns to scale in $F(\cdot)$, the firm will earn zero profit, and we therefore need not worry about to whom profit in the firm accrues.

8.1.3 Equilibrium and Aggregation

In period t , there are N_{t-1} old households who, in aggregate, supply $N_{t-1}s_{t-1}$ units of capital to the representative firm. Denote this by K_t . Because this capital was chosen prior to period t , we can treat the initial aggregate stock of capital as exogenous. Total capital available for the firm in $t + 1$ will be N_t times the saving of young households, or:

$$K_{t+1} = N_t s_t \quad (8.12)$$

To derive the aggregate resource constraint, let both (8.1) and (8.2) hold with equality and sum across the number of agents. Doing so, we obtain:

$$N_t c_{y,t} + N_t s_t = N_t w_t \quad (8.13)$$

$$N_{t-1} c_{0,t} = [R_t + (1 - \delta)] N_{t-1} s_{t-1} \quad (8.14)$$

Making use of (8.12) and defining $C_{y,t} = N_t c_{y,t}$ and $C_{0,t} = N_{t-1} c_{0,t}$ as aggregate consumption of young and old households, respectively, (8.13)-(8.14) may be written:

$$C_{y,t} + K_{t+1} = N_t w_t \quad (8.15)$$

$$C_{0,t} = [R_t + (1 - \delta)] K_t \quad (8.16)$$

Summing (8.15)-(8.16) together, we get:

$$C_{y,t} + C_{0,t} + K_{t+1} - (1 - \delta)K_t = w_t N_t + R_t K_t \quad (8.17)$$

As discussed in the Solow model, via the assumption of constant returns to scale $w_t N_t + R_t K_t = Y_t$. Furthermore, $K_{t+1} - (1 - \delta)K_t = I_t$, or aggregate investment. In effect, young households do total investment of K_{t+1} , whereas old households do *disinvestment* of $(1 - \delta)K_t$ (i.e. they consume their leftover capital before dying). Aggregate investment is the sum of investment by each generation of household. The same is true for aggregate consumption. (8.17) then reduces to an entirely conventional aggregate resource constraint:

$$C_t + I_t = Y_t \quad (8.18)$$

All told, the equilibrium of the economy is characterized by the following equations simultaneously holding:

$$s_t = s(w_t, R_{t+1}) \quad (8.19)$$

$$K_{t+1} = N_t s_t \quad (8.20)$$

$$I_t = K_{t+1} - (1 - \delta)K_t \quad (8.21)$$

$$Y_t = C_t + I_t \quad (8.22)$$

$$Y_t = AF(K_t, N_t) \quad (8.23)$$

$$R_t = AF_K(K_t, N_t) \quad (8.24)$$

$$w_t = AF_N(K_t, N_t) \quad (8.25)$$

$$C_t = C_{y,t} + C_{0,t} \quad (8.26)$$

$$C_{y,t} = N_t w_t - K_{t+1} \quad (8.27)$$

(8.19)-(8.27) feature nine endogenous variables (s_t , w_t , R_t , K_{t+1} , I_t , Y_t , C_t , $C_{y,t}$, and $C_{0,t}$) in nine equations. K_t , N_t , and A are exogenous. Let us assume that the size of the young population evolves exogenously according to:

$$N_t = (1 + n)N_{t-1} \quad (8.28)$$

That is, the growth rate of the youth population is given by $n \geq 0$. $n = 0$ would mean that the same number of households are born each period as die, so that the total population is constant. $n > 0$ means that more young households are born each period than old households die, so that the total population would be growing.

Because of potential growth in the population, it is convenient to re-write these equations in per capita terms, just as we did in the Solow model. w_t and R_t are factor prices and do not depend on the size of the population, and s_t is already expressed in per capita terms. For other variables, let lowercase variables denote the variable expressed relative to the size of the young population (which equals the workforce), i.e. $k_t = \frac{K_t}{N_t}$, $y_t = \frac{Y_t}{N_t}$, $c_{y,t} = \frac{C_{y,t}}{N_t}$, and so on. An exception is the consumption of the old population, for which we define $c_{0,t} = \frac{C_{0,t}}{N_{t-1}}$ since there are N_{t-1} old households alive in period t .

Divide both sides of (8.20) by N_{t+1} to get:

$$\frac{K_{t+1}}{N_{t+1}} = \frac{N_t}{N_{t+1}} s_t \quad (8.29)$$

Using (8.28) and our per capita notation, this is:

$$k_{t+1} = \frac{s_t}{1 + n} \quad (8.30)$$

Divide both sides of (8.23) by N_t and make use of the assumption that $F(\cdot)$ has constant returns to scale:

$$\frac{Y_t}{N_t} = AF\left(\frac{K_t}{N_t}, \frac{N_t}{N_t}\right) \quad (8.31)$$

As we did in the Solow model, define $f(k_t) = F(k_t, 1)$, allowing us to write:

$$y_t = Af(k_t) \quad (8.32)$$

As was discussed in Chapter 5, the assumption that $F(\cdot)$ is constant returns to scale implies that factor prices may be expressed in terms of the capital-labor ratio as:

$$R_t = Af'(k_t) \quad (8.33)$$

$$w_t = Af(k_t) - Ak_t f'(k_t) \quad (8.34)$$

The other equations are relatively straightforward to express in per worker terms. We are left with:

$$s_t = s(w_t, R_{t+1}) \quad (8.35)$$

$$k_{t+1} = \frac{s_t}{1+n} \quad (8.36)$$

$$i_t = k_{t+1}(1+n) - (1-\delta)k_t \quad (8.37)$$

$$y_t = c_t + i_t \quad (8.38)$$

$$y_t = Af(k_t) \quad (8.39)$$

$$R_t = Af'(k_t) \quad (8.40)$$

$$w_t = Af(k_t) - Ak_t f'(k_t) \quad (8.41)$$

$$c_t = c_{y,t} + \frac{c_{o,t}}{1+n} \quad (8.42)$$

$$c_{y,t} = w_t - k_{t+1}(1+n) \quad (8.43)$$

(8.35)-(8.43) are the same as (8.19)-(8.27), except they are written in per worker terms and N_t and has been eliminated using (8.28).

The key endogenous variable in (8.35)-(8.43) is k_{t+1} ; the rest of the endogenous variables are extraneous, since once k_{t+1} is determined these are all determined. (8.35), (8.40), and (8.41) can be combined together to yield:

$$k_{t+1} = \frac{s(Af(k_t) - Ak_t f'(k_t), Af'(k_{t+1}))}{1+n} \quad (8.44)$$

(8.44) is the central equation of the OLG model. It is a difference equation implicitly relating k_{t+1} to k_t , A , and parameters. It only *implicitly* forms this relationship because k_{t+1} appears on both the left and right hand sides. This caveat aside, (8.44) is not fundamentally different than the central equation of the Solow model – given k_t , A , and parameters, k_{t+1} is determined from one equation. The main difference relative to the Solow model is that rather than assuming a simple saving rule, we have instead derived one based on dynamic intertemporal optimization.

The downside of having derived a saving function from first principles, however, is that without having a specific functional form for $s(\cdot)$, it is difficult to say much about the properties of this difference equation, such as whether there exists a point where $k_{t+1} = k_t$ and, if so, whether such a point is unique. In the next section, we will make functional form assumptions on $u(\cdot)$ and $F(\cdot)$ which lead to a particularly simple form of $s(\cdot)$ with a number of desirable properties.

8.2 Cobb-Douglas Production and Logarithmic Utility

Let us suppose that the flow utility function of household is the natural log, i.e. $u(\cdot) = \ln(\cdot)$. With this specification of preferences, (8.5) may be written:

$$\frac{1}{w_t - s_t} = \beta [R_{t+1} + (1 - \delta)] \frac{1}{[R_{t+1} + (1 - \delta)] s_t} \quad (8.45)$$

(8.45) simplifies nicely:

$$\frac{1}{\beta} = \frac{w_t - s_t}{s_t} \quad (8.46)$$

Simplifying further so as to isolate s_t on the left hand side, we obtain:

$$s_t = \frac{\beta}{1 + \beta} w_t \quad (8.47)$$

(8.47) has a clean interpretation. Since $\frac{\beta}{1 + \beta} < 1$, it says that young households save a constant fraction of their income earned in youth. This is similar to the Solow model, except that the saving rate has been derived from an optimization problem. We can see that the bigger is β , the bigger the share of its income a young household will choose to save. This is quite intuitive – the bigger is β , the more patient the household is, and, other things being equal, the more it ought to want to save. Finally, related to our discussion above, note that the saving of young households does not depend on R_{t+1} with this particular specification of preferences. In effect, with logarithmic utility the income and substitution effects associated with R_{t+1} exactly cancel out.

If the production function is Cobb-Douglas (i.e. $F(K_t, N_t) = K_t^\alpha N_t^{1-\alpha}$, with $0 < \alpha < 1$), the real wage paid to young households is:

$$w_t = (1 - \alpha) A K_t^\alpha N_t^{-\alpha} \quad (8.48)$$

This can be written in terms of capital per capita as:

$$w_t = (1 - \alpha) A k_t^\alpha \quad (8.49)$$

Note that with Cobb-Douglas production the per worker production function is simply:

$$y_t = A f(k_t) = A k_t^\alpha \quad (8.50)$$

Hence, the real wage is simply proportional to output, with $w_t = (1 - \alpha)y_t$. And since saving of young households is just proportional to the real wage, saving of these households is

therefore simply proportional to total output per worker, which is again similar to the Solow model.

(8.49) can be combined with (8.47) in conjunction with (8.36) to derive the central equation of the OLG model with these functional form assumptions:

$$k_{t+1} = \frac{\beta(1-\alpha)Ak_t^\alpha}{(1+\beta)(1+n)} \quad (8.51)$$

The difference equation in (8.51) has similar properties to the central equation in the Solow model. In particular, the slope is:

$$\frac{dk_{t+1}}{dk_t} = \frac{\alpha\beta(1-\alpha)A}{(1+\beta)(1+n)} k_t^{\alpha-1} \geq 0 \quad (8.52)$$

This slope is positive, so k_{t+1} is increasing in k_t . Furthermore, when $k_t \rightarrow 0$, $k_t^{\alpha-1} \rightarrow \infty$, so it starts out very steeply sloped. But when $k_t \rightarrow \infty$, $k_t^{\alpha-1} \rightarrow 0$, so when k_t gets very large the slope goes to zero. Similarly to what we did in the Solow model, we can plot k_{t+1} as a function of k_t . It starts in the origin with a very steep slope, increases at a decreasing rate, and asymptotes to a slope of zero. Because it starts with a slope greater than one and ends with a slope of zero, and because it is continuous and starts in the origin, it must cross a 45 degree line showing points where $k_{t+1} = k_t$ exactly once away from the origin. This means that there exists a steady state in which $k_{t+1} = k_t = k^*$. Furthermore, because the curve lies above the line for $k_t < k^*$ and below the 45 degree line when $k_t > k^*$, the steady state is stable. This is depicted graphically in Figure 8.1 below:

Figure 8.1: Plot of the Central Equation of the OLG Model

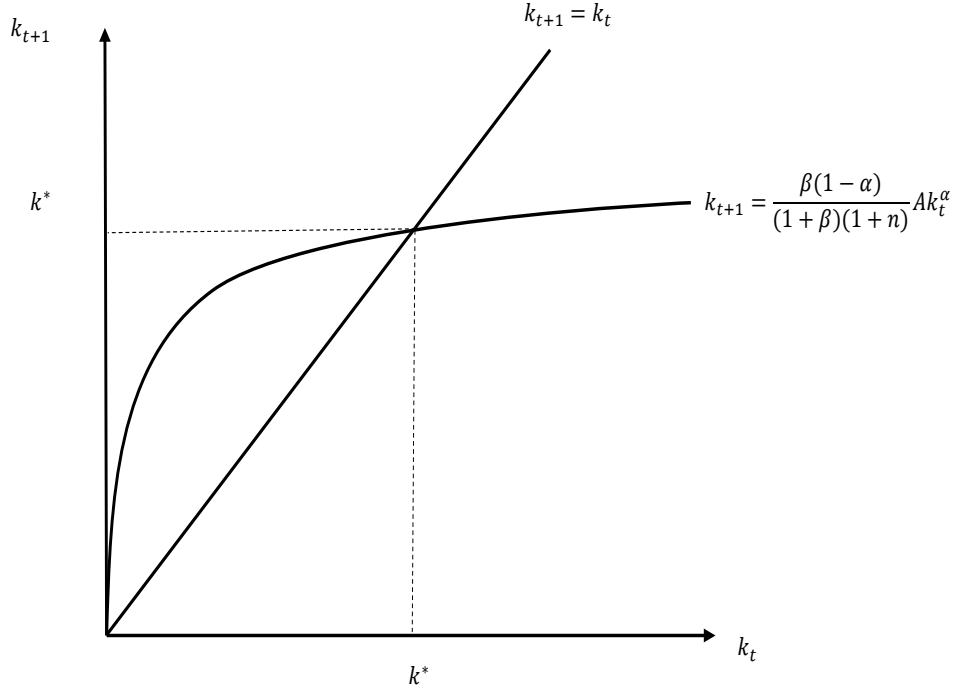

Algebraically, the steady state can be solved for as:

$$k^* = \left(\frac{\beta(1-\alpha)A}{(1+\beta)(1+n)} \right)^{\frac{1}{1-\alpha}} \quad (8.53)$$

The OLG model with these functional form assumptions will have similar properties to the Solow model. Suppose that, in period t , the old generation is endowed with a capital stock that is less than the steady state capital stock, $k_t < k^*$. This is depicted graphically in Figure 8.2 below. The next period's capital stock per worker, k_{t+1} , can be determined off the curve given the initial k_t . We observe that $k_{t+1} > k_t$. We can then iterate forward through time by reflecting off of the 45 degree line. In period $t + 1$, the economy will start with k_{t+1} which is still less than k^* . This means that $k_{t+2} > k_{t+1}$, and the process will continue until the capital stock per worker settles down to the steady state. Something similar would happen, but in reverse, if the economy were initially endowed with more than the steady state capital stock.

Figure 8.2: Dynamics in the OLG Model

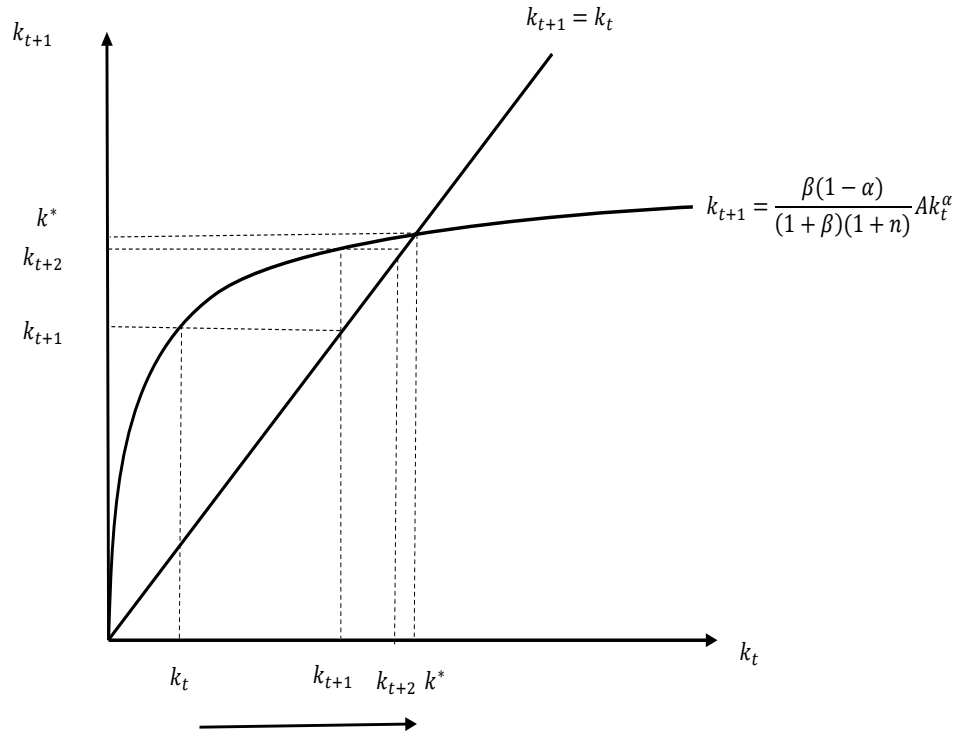

We consider a couple of quantitative experiments to see how the model works in practice. Suppose that $\beta = 0.95$ and $\alpha = 1/3$. Suppose that $n = 0.05$ (so that the number of young households born increases by 5 percent each period). Suppose $A = 1$. Then the steady state capital stock works out $k^* = 0.172$. Figure 8.3 shows the dynamic trajectories of capital per worker from three different initial starting values in period 0 – one where the economy starts in the steady state, another where it starts 50 percent above the steady, and another where it starts 50 percent below the steady state.

Figure 8.3: Quantitative Convergence in the OLG Model

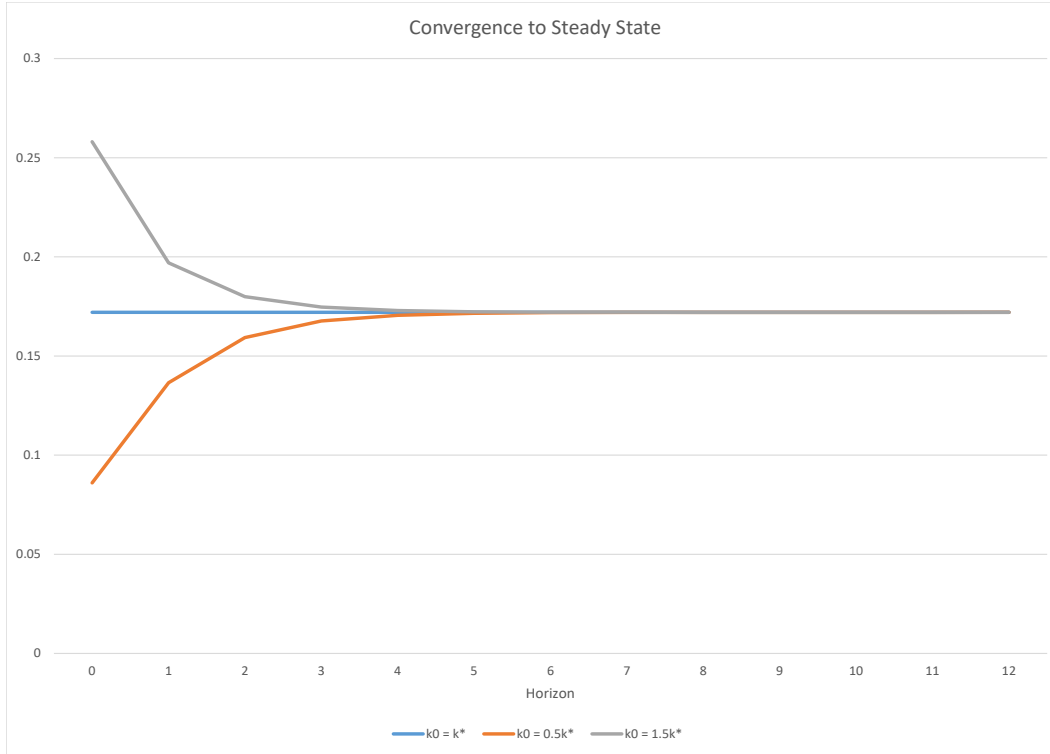

We can observe that if the economy starts in the steady state, it stays there. If it starts above, it converges down to the steady state, and similarly from below. This is qualitatively similar to the Solow model. There are a couple of interesting differences worth highlighting, however. First, for similar parameter values the steady state capital stock is *much* lower in the OLG model in comparison to the Solow model. Second, the economy converges to the steady *much* quicker in the OLG model in comparison to the Solow model.

To understand why these differences arise, it is useful to return to the expression for the steady state capital stock per worker in the augmented Solow model from Chapter 6. See, in particular, (6.63). Setting the growth rate of labor augmenting technology, z , equal to zero, the expression for the steady state capital stock per worker in that model can be written:

$$k^* = \left(\frac{sA}{\delta + n} \right)^{\frac{1}{1-\alpha}} \quad (8.54)$$

We can interpret (8.54) similarly to (8.53). The effective saving rate in the OLG economy is $\frac{\beta(1-\alpha)}{(1+\beta)(1+n)}$. Given values of β , α , and n , one can choose the saving rate in the Solow model to be the same, i.e. $s = \frac{\beta(1-\alpha)}{(1+\beta)(1+n)}$. For the parameter values used above, the comparable saving rate in the Solow model would be about 0.3. What is different between the OLG and Solow economies is that the steady state capital stock per worker *does not* depend on capital's

depreciation rate, δ , in the OLG model. Indeed, the two economies are essentially identical if $\delta \rightarrow 1$ in the Solow model, regardless of what the value of δ is in the OLG economy. What is going on is the following. In the OLG economy, capital effectively depreciates completely each period, regardless of what the actual depreciation rate on capital is. This is because there is no intergenerational transfer of capital – each period, the old generation simply consumes any leftover capital before dying. As a result, the capital stock available for production in any period is newly created each period. Because of this, capital does not accumulate in the OLG economy in the way that it does in the Solow economy where there is a single representative household that lives in perpetuity. The steady state capital stock is consequently much smaller in the OLG economy and transition dynamics take place much faster for otherwise similar parameter values in comparison to the Solow model.

All that said, there is a subtle issue in comparing the two models related to the interpretation of a unit of time. In the Solow model, a household lives forever, and a unit of time can be interpreted however one pleases, with a year perhaps a natural starting point. In the OLG economy, a household lives only two periods, and it is therefore most appropriate to think of a unit of time as corresponding to roughly a generation, so thirty or so years. For example, a depreciation rate at an annual frequency of 10 percent corresponds to depreciation over a thirty year period of about 95 percent (i.e. $(1 - \delta)^{30} \approx 0.05$ when $\delta = 0.1$, so 95 percent of the capital stock would become obsolete after 30 years). Furthermore, a discount factor of $\beta = 0.95$ at an annual frequency corresponds to a discount factor over a generation of about 0.2 (i.e. $\beta^{30} \approx 0.2$ for $\beta = 0.95$). Finally, the growth rate of the population, n , ought to be thought of as the growth rate per generation, not per year. If the population grows at 1 percent per year, then over thirty years it ought to grow at $(1 + n)^{30} \approx 35$. Taking these subtle issues into account, the steady state and dynamics of the OLG and Solow models do *not* look as different as one might conclude in the paragraph above.

As in the Solow model, it is possible to examine the dynamic effects of changes in A or other parameters (e.g. β , which would influence how much young households choose to save). We leave these as exercises, only noting that the effects are similar to what would obtain in the Solow model.

8.3 The Golden Rule and Dynamic Inefficiency

In the Solow model, we introduced the concept of the Golden Rule and put forth the possibility that an economy could be saving too much. In this sense, an economy could be dynamically inefficient in that it could increase consumption in the present and all subsequent periods by simply saving a smaller fraction of output each period. We now return to this

discussion in the context of the OLG economy with logarithmic utility and Cobb-Douglas production. We use the model to document exactly how and why the economy might be dynamically inefficient as well as how a benevolent government might be able to employ intergenerational transfers to restore steady state efficiency.

In the Solow model, the Golden Rule was defined as the saving rate which maximized steady state consumption per worker (or per efficiency unit of labor in the augmented model). It is somewhat trickier to define such a concept in the OLG economy for two reasons. First, there is no explicit saving rate in an OLG economy; rather, the saving rate is a function of deep parameters related to preferences and technology. Second, at any point in time, there are two kinds of households alive. A level of saving which maximizes the steady state consumption of one generation may not do so for the other.

We will therefore conceptualize the Golden Rule in terms of the steady state capital stock per worker (rather than a saving rate) which maximizes aggregate consumption per worker, given above in (8.43). To the extent to which $n > 0$, this implicitly puts more weight on the consumption of young households because there are more young than old households at any point in time. For the general functional form, assuming a steady state exists, we can solve for steady state investment per worker from (8.37) as:

$$i^* = (\delta + n)k^* \quad (8.55)$$

Steady state total consumption per worker is then:

$$c^* = y^* - (\delta + n)k^* \quad (8.56)$$

In terms of the per worker production function, this is simply:

$$c^* = Af(k^*) - (\delta + n)k^* \quad (8.57)$$

The Golden Rule capital stock maximizes c^* . Hence, it must satisfy:

$$\frac{dc^*}{dk^*} = 0 \Leftrightarrow Af'(k^*) = \delta + n \quad (8.58)$$

Note that (8.58) is *exactly* the same condition (assuming $z = 0$) implicitly characterizing the Golden Rule in the augmented Solow model (see (6.67)). Using the Cobb-Douglas functional form assumption (8.58) can be written:

$$\alpha Ak^{*\alpha-1} = \delta + n \quad (8.59)$$

This means that the Golden Rule capital stock satisfies:

$$k^{*,gr} = \left(\frac{\alpha A}{\delta + n} \right)^{\frac{1}{1-\alpha}} \quad (8.60)$$

Nothing guarantees that (8.60) coincides with (8.53). For the steady state capital stock to be consistent with the Golden Rule, the following must be satisfied:

$$\frac{\alpha(1+\beta)(1+n)}{\beta(1-\alpha)} = \delta + n \quad (8.61)$$

We can define an economy as being dynamically inefficient if $\frac{dc^*}{dk^*} < 0$. If this were the case, consumption could be higher by reducing the steady state capital stock. Reducing the steady state capital stock would entail immediately increasing consumption of young households, and so aggregate consumption per capita could increase both in the present and in the future by simply accumulating less capital. Let us examine the parameter values for which a situation of dynamic inefficiency might arise. The derivative of steady state consumption with respect to the steady state capital stock being negative would require that:

$$\frac{\alpha(1+\beta)(1+n)}{\beta(1-\alpha)} < \delta + n \quad (8.62)$$

The economy is most likely to be dynamically inefficient when (i) δ is large, (ii) β is large, (iii) α is small, or (iv) n is large. What is the intuition for why an economy could potentially be dynamically inefficient, and why does this possibility depend on these parameters in the way described above? In the OLG economy, the only way for young households to provide for their consumption in old age is to save. They must save *regardless* of whether the steady state return to saving, $R^* + (1-\delta)$, is high or low if they wish to consume in old age. Suppose that δ is very high, for example. Then the steady state return to saving is comparatively low. If this is the case, saving is a relatively inefficient way to transfer resources intertemporally. Both generations could conceivably be better off if there were a way to instead directly transfer resources across generations – i.e. to subsidize the consumption of the old and finance this with a tax on saving of the young. A similar result would obtain if α is small (which other things being equal makes R^* small) or β is large (a large β increases k^* and reduces R^*). If n is very large, there are many more young households than old at a given point in time. One therefore needs to tax young households at a comparatively low rate to subsidize consumption of the old.

As we shall show in the next section, if an economy finds itself in the dynamically inefficient range, it is conceivably possible for a benevolent government to make *all* generations better off through a tax and transfer system.

8.3.1 Government Intervention

Suppose that there is a government. This government does no consumption, but it can tax saving via the constant rate τ . The flow budget constraint for a young household in period t becomes:

$$c_{y,t} + (1 + \tau_s)s_t \leq w_t \quad (8.63)$$

In (8.63), if $\tau > 0$ then saving is expensive compared to consuming. The government can use the proceeds from the tax on saving to *subsidize* the capital income old households. In particular, suppose that it does so at rate $(1 + \tau_k)$. The flow budget constraint of an old household is:

$$c_{0,t+1} \leq [(1 + \tau_k)R_{t+1} + (1 - \delta)]s_t \quad (8.64)$$

For the government's tax and transfer system to be consistent with a balanced budget (i.e. we do not allow for the possibility that the government may issue debt), it must be that total revenue raised by the tax on saving equals the total cost of the capital tax subsidy in any period:

$$\tau_s N_t s_t = \tau_k R_t N_{t-1} s_{t-1} \quad (8.65)$$

Preferences of a household are the same. With the new budget constraints, (8.63)-(8.64), the first order optimality condition for a young household making a saving decision is:

The first order optimality condition for the household is similar to (8.5):

$$(1 + \tau_s)u'(w_t - (1 + \tau_s)s_t) = \beta [(1 + \tau_K)R_{t+1} + (1 - \delta)] u'([(1 + \tau_K)R_{t+1} + (1 - \delta)]s_t) \quad (8.66)$$

If we once again assume log utility, (8.66) simply becomes:

$$\frac{1 + \tau_s}{w_t - (1 + \tau_s)s_t} = \beta \frac{1}{s_t} \quad (8.67)$$

Solving (8.67) for s_t , we obtain:

$$s_t = \frac{\beta}{(1 + \beta)(1 + \tau_s)} w_t \quad (8.68)$$

Note that (8.68) reduces to (8.47) when $\tau_s = 0$. Quite naturally, the bigger is τ_s , the smaller will be s_t for a given w_t . If we once again assume Cobb-Douglas production, then

$w_t = (1 - \alpha)Ak_t^\alpha$. Then the central equation of the OLG model, (8.36), may be written:

$$k_{t+1} = \frac{\beta(1 - \alpha)Ak_t^\alpha}{(1 + \beta)(1 + \tau_s)(1 + n)} \quad (8.69)$$

The steady state capital stock per worker can be solved for as:

$$k^* = \left(\frac{\beta(1 - \alpha)A}{(1 + \beta)(1 + \tau_s)(1 + n)} \right)^{\frac{1}{1 - \alpha}} \quad (8.70)$$

If the government wishes to implement the Golden Rule capital stock, it can set τ_s so that (8.70) coincides with the Golden Rule steady state capital stock, (8.60). Doing so requires that:

$$\frac{\beta(1 - \alpha)}{(1 + \beta)(1 + \tau_s)(1 + n)} = \frac{\alpha}{\delta + n} \quad (8.71)$$

Simplifying terms:

$$\frac{\beta(1 - \alpha)(\delta + n)}{\alpha(1 + \beta)(1 + n)} = (1 + \tau_s) \quad (8.72)$$

After some algebraic simplification, we can solve for τ_s as:

$$\tau_s = \frac{\beta(1 - \alpha)(\delta + n) - (1 + \beta)\alpha(1 + n)}{\alpha(1 + \beta)(1 + n)} \quad (8.73)$$

Note that the τ_s necessary to achieve the Golden Rule could be positive or negative. It will be positive when:

$$\beta(1 - \alpha)(\delta + n) > (1 + \beta)\alpha(1 + n) \quad (8.74)$$

Note that (8.74) is *exactly* the same condition for the economy to be dynamically inefficient derived above, (8.62). In other words, what (8.73) tells us is that if the economy is dynamically inefficient, saving should be taxed (i.e. $\tau_s > 0$). In contrast, if the economy is below the Golden Rule, to get to the Golden Rule saving should be *subsidized* (i.e. $\tau_s < 0$). Let us see what τ_k must be for the government to balance its budget under a plan to implement the Golden Rule. Combine (8.68) with (8.65), while noting that $N_{t-1}s_{t-1} = K_t$, to obtain:

$$\frac{\tau_s \beta}{(1 + \beta)(1 + \tau_s)} N_t w_t = \tau_k R_t K_t \quad (8.75)$$

Because of Cobb-Douglas production, we must have $N_t w_t / (R_t K_t) = \frac{1 - \alpha}{\alpha}$. Hence, τ_k must satisfy:

$$\tau_k = \frac{1 - \alpha}{\alpha} \frac{\tau_s \beta}{(1 + \beta)(1 + \tau_s)} \quad (8.76)$$

Let us do a couple of quantitative experiments to examine how a government *might* be able to improve total welfare in an economy by implementing taxes. Let us first consider the parameter configuration in which there are no taxes – i.e. $\tau_s = \tau_k = 0$. Suppose that $\alpha = 0.2$, $\beta = 0.95$, $\delta = 0.1$, and $n = 0.5$. These parameters are slightly different than those considered in the example above, but we choose them to ensure that consumption of neither generation of agent ever goes negative. With these parameters, the economy is *not* dynamically inefficient. Referencing (8.74), we have $\beta(1 - \alpha)(\delta + n) = 0.456$, whereas $(1 + \beta)\alpha(1 + n) = 0.585$. The steady state capital stock per worker comes out to $k^* = 0.186$. Steady state total consumption and consumption by generation are: $c^* = 0.602$, $c_y^* = 0.293$, and $c_o^* = 0.465$. Steady state lifetime utility for a young household is $U = \ln(c_y^*) + \beta \ln(c_o^*) = -1.99$.²

Suppose that the economy sits in this steady state from period 0 to period 2. Then, in period 3, a government decides to implement a tax system to move the economy to the Golden Rule; i.e. it sets τ_k according to (8.76) and τ_s according to (8.73). This requires setting $\tau_s = -0.22$ and $\tau_k = -0.55$ – in other words, saving is *subsidized* and capital income is taxed. The economy will eventually converge to a new steady state with higher capital ($k^* = 0.253$), but it takes a few periods to get there.

Figure 8.4 plots the dynamic trajectories of capital per worker (upper left), consumption (both aggregate consumption and consumption of each generation, upper right), and utility (lower left). For the utility graph, we show lifetime utility for young agents – i.e. $U = u(c_{y,t}) + \beta u(c_{o,t+1})$ – whereas for old agents we simply show utility from current consumption – i.e. $u(c_{o,t})$.

²Note that utility is an ordinal concept and there is nothing wrong with utility being negative, as we discuss later in the book.

Figure 8.4: Implementing Taxes to Hit the Golden Rule

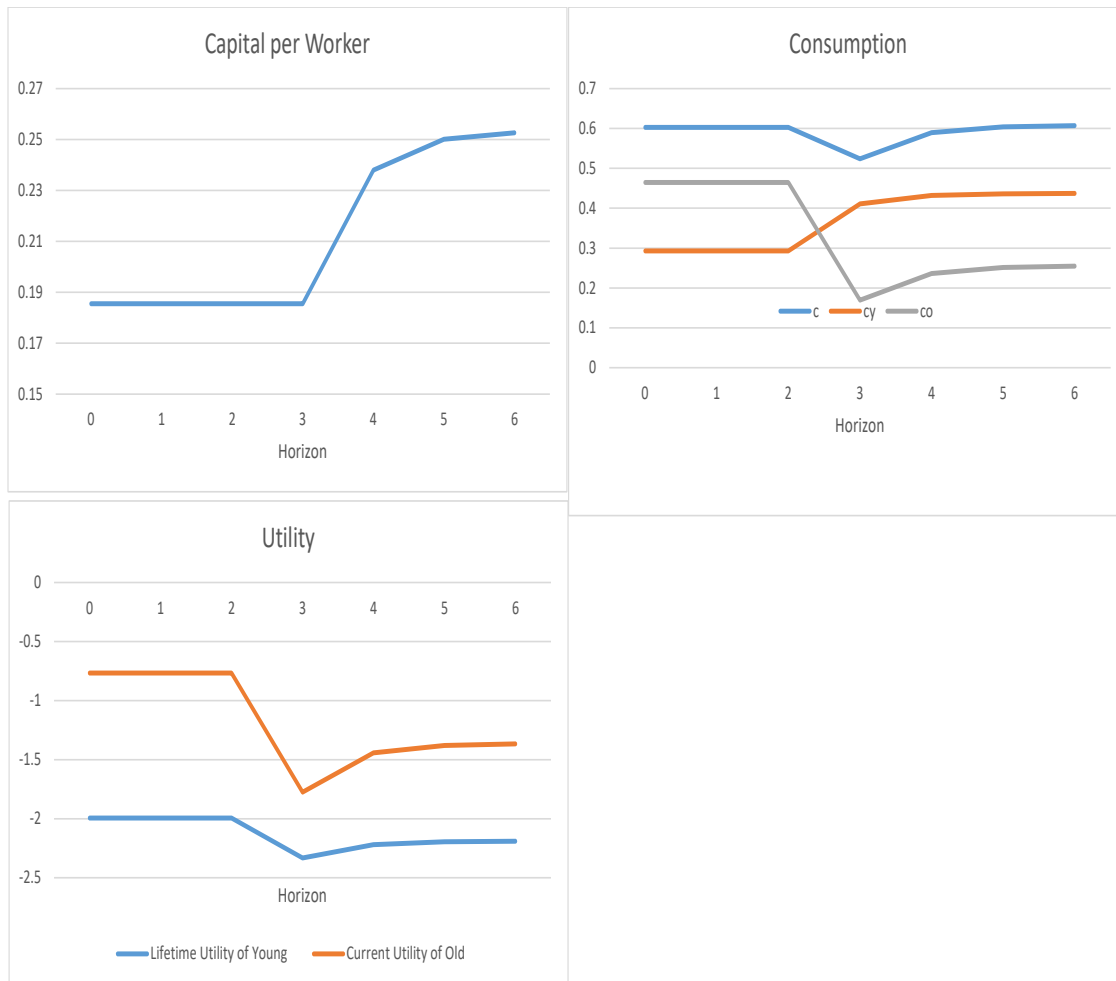

As we can see, subsidizing saving results in more capital accumulation. It also results in more consumption for young households (both in the present and in all future periods). But because subsidizing saving requires taxing capital income, the old generation is hurt in period 3 when the tax system is implemented – its consumption falls. Aggregate consumption initially falls, but ultimately ends up higher than where it started once the economy settles to its new steady state. This is conceptually similar to the Solow model – increasing saving when starting from below the Golden Rule results in an initial fall in consumption but higher consumption in the long run.

Does the implementation of this tax system make households better off? To see this, focus on the lower left plot. The current utility of the old generation alive at the time the tax system is implemented falls from -0.76 to -1.77 . It is rather obvious old households would be hurt because their consumption is lower. Furthermore, even though consumption is higher for young households, lifetime utility for these households actually falls (both immediately

when the tax system is implemented as well as when the economy settles down to its new steady state). The extra consumption in youth is not enough to compensate them for the lower consumption in old age. Since both young and old households end up with lower utility, implementing the Golden Rule via a tax system starting from the initial steady state described above would evidently *not* be a desirable thing for a government to do.

Suppose instead that the economy initially sits in a steady state but is dynamically inefficient in the sense of being above the Golden Rule capital stock. In particular, keep the same parameters as above but instead assume that $\delta = 0.5$. This makes $\beta(1 - \alpha)(\delta + n) = 0.76$, whereas $(1 + \beta)\alpha(1 + n)$ remains at 0.585. Assuming no taxes, the initial steady state capital stock is $k^* = 0.186$.

Suppose that the economy sits in this steady state from period 0 to period 2. Then, in period 3, the government implements the tax system described above to achieve the Golden Rule. It must therefore set $\tau_s = 0.3$ and $\tau_k = 0.448$. In other words, it is taxing saving and using the proceeds from this tax to subsidize capital income. Figure 8.5 below plots dynamic trajectories of selected variables after this change.

Figure 8.5: Implementing Taxes to Hit the Golden Rule: Starting from Dynamic Inefficiency

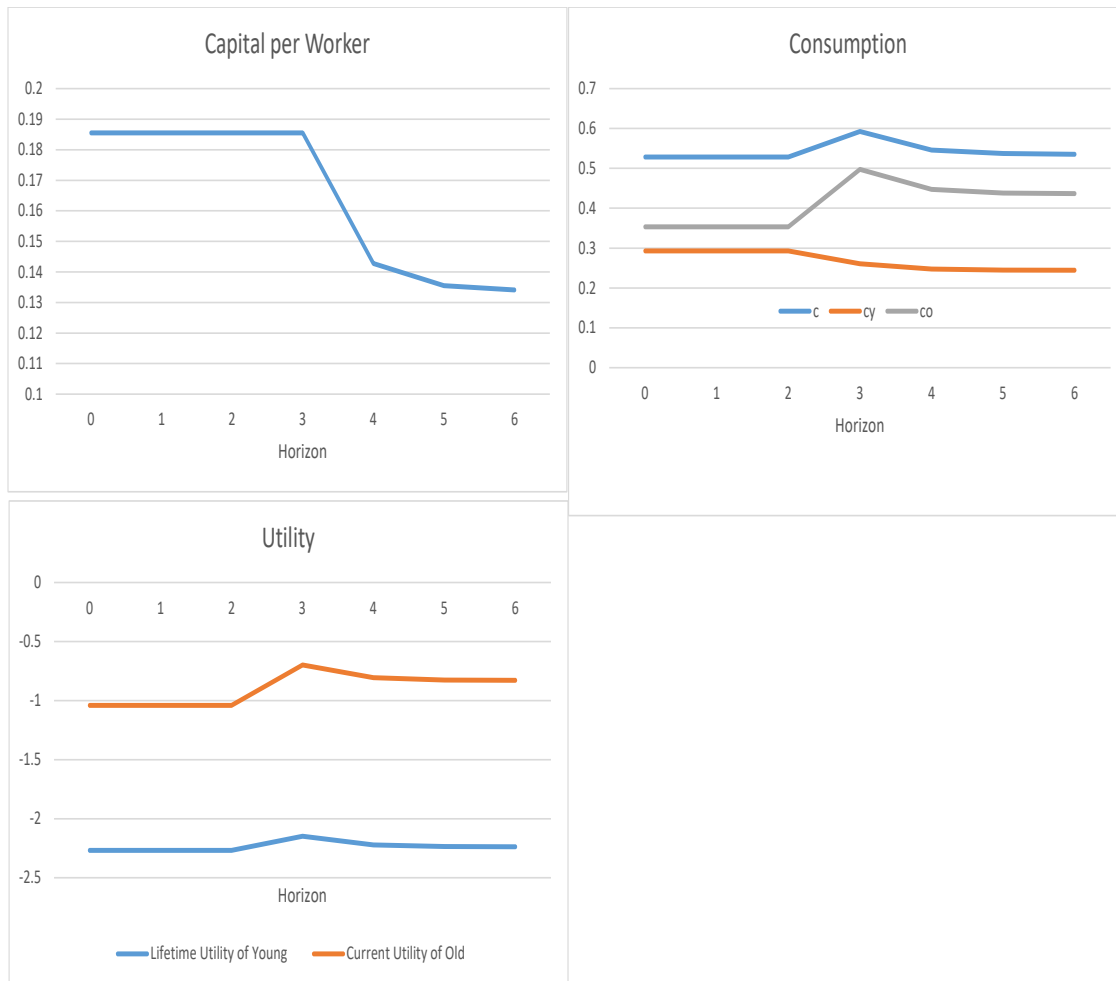

Because the government switches to taxing saving, capital accumulation falls and the economy converges to a lower steady state capital stock. The consumption of young households falls both initially as well as in the new steady state, but the consumption of old households rises. Furthermore, aggregate consumption initially rises and then declines, but it ultimately always remains higher than where it began. This is again similar to the Solow model, where decreasing the saving rate from a position initially above the Golden Rule results in higher consumption both in the present and at every subsequent date.

In the lower left plot we again show utility of the two types of agents. The old generation alive at the time the tax system is implemented naturally benefits in the form of higher utility – its consumption is higher, and so that generation is better off. It is also better off in all subsequent periods. What is interesting is that the young generation also benefits – even though its consumption immediately falls, the higher consumption it gets to enjoy in old age is more than enough to make up for it. The lifetime utility of young households is higher at

every subsequent date after the implementation of the tax system.

It is instructive to compare the results shown in Figures 8.5 and 8.4. In Figure 8.5, *all generations* (both the young and old generations at the time the tax is implemented, as well as future generations yet to be born) are better off after the implementation of the tax system. Since it is possible to improve the welfare of *all* generations, the initial situation of dynamic inefficiency is what economists call *Pareto inefficient*. An allocation is said to be Pareto inefficient if it is possible to redistribute resources in such a way as to make at least some agents better off and no agents worse off. This is the case depicted in Figure 8.5. This is not the case in Figure 8.4. In that case, implementing a tax system to achieve the Golden Rule actually makes all generations worse off. That result is somewhat sensitive to the particulars of the parameterization – it is conceivable that implementing the Golden Rule starting from a steady state which is not dynamically inefficient could improve the welfare of some generations and hurt it for others, but it is not possible to make *all* generations better off by implementing such a tax system if the economy is initially not dynamically inefficient. In contrast, if the economy is initially dynamically inefficient, implementation of a tax and transfer system like the one described above can be unambiguously welfare-enhancing.

8.4 Incorporating Exogenous Technological Growth

In the OLG model, an economy (might) converge to a steady state in which it does not grow. We include “(might)” because without saying something more specific about preferences and production it is possible a steady state does not exist. Let us assume, however, that a steady state does exist (as it does with the preference and production assumptions considered throughout this chapter). If that is the case, then over long horizons this economy will exhibit no growth. Similarly to the Solow model, this counterfactual prediction can be remedied by re-writing the model to allow for exogenous growth in a technology variable.

Once again let Z_t denote the level of labor augmenting technology. While similar to A_t , Z_t directly multiplies labor input in the aggregate production function. Formally:

$$Y_t = AF(K_t, Z_t N_t) \tag{8.77}$$

For notational ease we once again treat $A_t = A$ as constant. The real wage equals the marginal product of labor, which in this case is:

$$w_t = AZ_t F_N(K_t, Z_t N_t) \tag{8.78}$$

The rental rate on capital is again just the marginal product of capital:

$$R_t = AF_K(K_t, Z_t N_t) \quad (8.79)$$

One can see the difference between A and Z_t in (8.78)-(8.79). Whereas A directly impacts the marginal product of both factors, Z_t only directly impacts the marginal product (and hence factor price) of labor input.

We shall assume that Z_t grows at an exogenous and constant rate, $z \geq 0$:

$$Z_t = (1 + z)Z_{t-1} \quad (8.80)$$

Other than these additions, the general OLG model in the levels of variables is identical to what is presented above, (8.19)-(8.27). To make progress in analyzing the model, let us assume that flow utility is the natural log and that production is Cobb-Douglas. Rather than re-writing the equilibrium conditions in per worker terms, let us define $\widehat{x}_t = \frac{X_t}{Z_t N_t}$ as a variable per efficiency unit of labor, for some variable X_t . The equilibrium conditions in levels taking account of this growth, and making these functional form assumptions, are:

$$s_t = \frac{\beta}{1 + \beta} w_t \quad (8.81)$$

$$K_{t+1} = N_t s_t \quad (8.82)$$

$$I_t = K_{t+1} - (1 - \delta)K_t \quad (8.83)$$

$$Y_t = C_t + I_t \quad (8.84)$$

$$Y_t = AK_t^\alpha (Z_t N_t)^{1-\alpha} \quad (8.85)$$

$$R_t = \alpha AK_t^{\alpha-1} (Z_t N_t)^{1-\alpha} \quad (8.86)$$

$$w_t = (1 - \alpha)AZ_t K_t^\alpha (Z_t N_t)^{-\alpha} \quad (8.87)$$

$$C_t = C_{y,t} + C_{o,t} \quad (8.88)$$

$$C_{y,t} = N_t w_t - K_{t+1} \quad (8.89)$$

With this preference and production specification there exists a balanced growth path. Per worker variables, like s_t , grow at the rate of labor augmenting technology. Therefore, define $\widehat{s}_t = \frac{s_t}{Z_t}$. The real wage, as in the Solow model, will also grow at the rate of labor augmenting technology. Therefore define $\widehat{w}_t = \frac{w_t}{Z_t}$. (8.81) can be therefore be written:

$$\widehat{s}_t = \frac{\beta}{1 + \beta} \widehat{w}_t \quad (8.90)$$

Divide both sides of (8.82) by $Z_t N_t$;

$$\frac{K_{t+1}}{Z_t N_t} = \frac{N_t s_t}{Z_t N_t} \quad (8.91)$$

Multiply and divide the left hand side of (8.91) by $Z_{t+1} N_{t+1}$, and make use of the fact that $\frac{Z_{t+1} N_{t+1}}{Z_t N_t} = (1+z)(1+n)$, to write this as:

$$\widehat{k}_{t+1} = \frac{\widehat{s}_t}{(1+z)(1+n)} \quad (8.92)$$

Note that (8.92) reduces to (8.36) when $z = 0$. (8.83) and (8.84) can be similarly transformed to:

$$\widehat{i}_t = (1+z)(1+n)\widehat{k}_{t+1} - (1-\delta)\widehat{k}_t \quad (8.93)$$

$$\widehat{y}_t = \widehat{c}_t + \widehat{i}_t \quad (8.94)$$

The production function and expression for the real wage are straightforward to transform into per efficiency unit variables:

$$\widehat{y}_t = A\widehat{k}_t^\alpha \quad (8.95)$$

$$\widehat{w}_t = (1-\alpha)A\widehat{k}_t^{\alpha-1} \quad (8.96)$$

Note that the rental rate on capital is stationary along a balanced growth path, and needs no transformation:

$$R_t = \alpha A\widehat{k}_t^{\alpha-1} \quad (8.97)$$

The aggregate resource constraint is straightforward to transform:

$$\widehat{y}_t = \widehat{c}_t + \widehat{i}_t \quad (8.98)$$

Divide both sides of (8.88) by $Z_t N_t$:

$$\frac{C_t}{Z_t N_t} = \frac{C_{y,t}}{Z_t N_t} + \frac{C_{o,t}}{Z_t N_t} \quad (8.99)$$

As before, we wish to scale consumption of the old generation by efficiency units of labor at the time of its birth. Hence, multiply and divide the last term by $Z_{t-1} N_{t-1}$:

$$\widehat{c}_t = \widehat{c}_{y,t} + \frac{C_{o,t}}{Z_{t-1} N_{t-1}} \frac{Z_{t-1} N_{t-1}}{Z_t N_t} \quad (8.100)$$

Note that (8.100) may be written as follows, which of course reduces to (8.42) when $z = 0$:

$$\widehat{c}_t = \widehat{c}_{y,t} + \frac{c_{o,t}}{(1+z)(1+n)} \quad (8.101)$$

Finally, turn to (8.89). Divide both sides by $Z_t N_t$:

$$\frac{C_{y,t}}{Z_t N_t} = \frac{N_t w_t}{Z_t N_t} - \frac{K_{t+1}}{Z_t N_t} \quad (8.102)$$

Which can be written:

$$\widehat{c}_{y,t} = \widehat{w}_t - \frac{K_{t+1}}{Z_{t+1} N_{t+1}} \frac{Z_{t+1} N_{t+1}}{Z_t N_t} \quad (8.103)$$

Which is just:

$$\widehat{c}_{y,t} = \widehat{w}_t - (1+z)(1+n)\widehat{k}_{t+1} \quad (8.104)$$

(8.104) of course reduces to (8.43) when $z = 0$. All told, the equilibrium conditions of the model re-written in stationary form are given below:

$$\widehat{s}_t = \frac{\beta}{1+\beta}\widehat{w}_t \quad (8.105)$$

$$\widehat{k}_{t+1} = \frac{\widehat{s}_t}{(1+z)(1+n)} \quad (8.106)$$

$$\widehat{i}_t = (1+z)(1+n)\widehat{k}_{t+1} - (1-\delta)\widehat{k}_t \quad (8.107)$$

$$\widehat{y}_t = \widehat{c}_t + \widehat{i}_t \quad (8.108)$$

$$\widehat{y}_t = A\widehat{k}_t^\alpha \quad (8.109)$$

$$R_t = \alpha A\widehat{k}_t^{\alpha-1} \quad (8.110)$$

$$\widehat{w}_t = (1-\alpha)A\widehat{k}_t^\alpha \quad (8.111)$$

$$\widehat{c}_t = \widehat{c}_{y,t} + \frac{\widehat{c}_{o,t}}{(1+z)(1+n)} \quad (8.112)$$

$$\widehat{c}_{y,t} = \widehat{w}_t - (1+z)(1+n)\widehat{k}_{t+1} \quad (8.113)$$

The central equation of the OLG model can be derived by combining (8.105) and (8.111) with (8.106):

$$\widehat{k}_{t+1} = \frac{\beta(1-\alpha)A\widehat{k}_t^\alpha}{(1+\beta)(1+z)(1+n)} \quad (8.114)$$

(8.114) is similar to (8.51) and reduces to it when $z = 0$. The allowance for $z \geq 0$ does not change the fact that a steady state capital stock per efficiency unit of labor exists. At this steady state, variables expressed in per efficiency terms are constant, and per worker variables grow at rate z , while level variables grow at approximately $z + n$. The proof of this is exactly as in Chapter 6 and is not repeated here. We simply wish to note that the steady state / balanced growth path properties of the OLG economy are *identical* to the Solow model and hence consistent with the time series stylized facts.

8.5 Summary

- As opposed to their representative agent counterparts, overlapping generation models feature economies where people are differentiated by age.
- Under some functional form assumptions, there is a unique and stable steady state. Increases in productivity and the discount factor raise steady-state capital and output. An increase in the growth rate of the population reduces them.
- The competitive equilibrium is usually not Pareto efficient. The reason is that there is a missing market between agents alive and those agents yet to be borne. In equilibrium, the economy might accumulate too much or too little capital relative to the efficient benchmark.
- A benevolent government can correct this market failure by issuing debt. Since the government is infinitely lived, this essentially solves the problem of missing markets.
- Since government debt affects equilibrium prices and quantities, Ricardian Equivalence does not hold.

Key Terms

-

Questions for Review

1. Recall that factor prices with Cobb Douglas production are

$$w_t = A(1 - \alpha)k_t^\alpha$$

$$R_t = A\alpha k_t^{\alpha-1}$$

- (a) Assuming log utility, solve for the steady-state wage and rental rates.

- (b) Plot the responses over time to a permanent increase in A .
- (c) Plot the responses over time to a permanent increase in n .
2. Suppose the lifetime utility function of a household is

$$U_t = \frac{c_{y,t}^{1-\sigma} - 1}{1-\sigma} + \beta \frac{c_{o,t+1}^{1-\sigma} - 1}{1-\sigma}$$

with $\sigma \geq 0$. The budget constraints are the same.

$$c_{y,t} + s_t = w_t$$

$$c_{o,t+1} = R_{t+1}s_t$$

- (a) Substitute the constraints into the objective function and take the first order condition for s_t .
- (b) Solve for the optimal s_t as a function of w_t , R_t , and parameters.
- (c) Is the derivative of the optimal s_t with respect to R_t unambiguous? How about with respect to w_t ? Explain the intuition of this.
3. Suppose that we include government spending in the model. Total government spending is given by

$$G_t = N_t \tau$$

where τ is a lump sum tax collected from all young agents. This means that per capita government spending, $g_t = \frac{G_t}{N_t}$ is constant and given by τ .

- (a) The utility maximization problem is

$$\max_{c_{y,t}, c_{o,t+1}, s_t} U_t = \ln c_{y,t} + \beta \ln c_{o,t+1}$$

$$\text{s.t. } c_{y,t} + s_t = w_t - \tau$$

$$c_{o,t+1} = s_t R_{t+1}.$$

Solve for the optimal s_t as a function of factor prices, τ , and other parameters.

- (b) The profit maximization problem is given by

$$\Pi_t = \max_{K_t, N_t} AK_t^\alpha N_t^{1-\alpha} - w_t N_t - R_t K_t$$

Derive the first order conditions for labor and capital.

- (c) The capital accumulation equation in per capita terms is

$$k_{t+1} = \frac{s_t}{1+n}.$$

Using your answers from the first two parts, write the accumulation equation as a function of k_t , exogenous variables and parameters.

- (d) Plot the capital accumulation line against the 45 degree line. Clearly label the steady state and show that it is stable.
- (e) Plot the effects of an increase in g .

Part III

The Microeconomics of Macroeconomics

All economics is microeconomics. Essentially every economic problem contains some person or firm maximizing an objective subject to constraints. Essentially every economic problem contains some notion of equilibrium in which the maximization problem of various market participants are rendered mutually consistent with market clearing conditions. As we discussed in Chapter 3, a major achievement in economics over the last forty years has been to incorporate these microeconomic fundamentals into models designed to answer macroeconomic questions. In this section, we cover each optimization problem in detail and how they come together in equilibrium.

Macroeconomics is focused on dynamics – i.e. the behavior of the aggregate economy across time. For most of the remainder of the book, we focus on a world with two periods. Period t is the present and period $t + 1$ represents the future. Two periods are sufficient to get most of the insights of the dynamic nature of economic decision-making. By virtue of being the largest component in GDP, consumption is covered in two chapters, 9 and 10. The key microeconomic insight is that consumption is a function of expected lifetime income rather than just current income. We also discuss how elements such as taxes, wealth, and uncertainty affect consumption decisions. In Chapter 11, we introduce the idea of a competitive equilibrium. A competitive equilibrium is a set of prices and allocations such that everyone optimizes and markets clear. In an economy without production, the market clearing conditions are straightforward and therefore represent an ideal starting point.

In Chapter 12 we derive the solution to the household’s problem when it chooses both how much to consume and how much to work. We also derive the firm’s optimal choice of capital and labor. Chapters 13 and 14 bring a government sector and money into the economy. Finally, we close in Chapter 15 by showing that the competitive equilibrium is Pareto Optimal. A key implication of this is that activist fiscal or monetary policy will not be welfare enhancing.

Chapter 16 studies the determinants of unemployment. Throughout the rest of the book, we are silent on unemployment and instead focus on hours worked as our key labor market indicator. In this Chapter we show some facts concerning unemployment, vacancies, and job finding rates. We then work through a stylized version of the Diamond-Mortenson-Pissarides (DMP) search and matching model of unemployment.

Chapter 9

A Dynamic Consumption-Saving Model

Modern macroeconomics is dynamic. One of the cornerstone dynamic models is the simple two period consumption-saving model which we study in this chapter. Two periods (the present, period t , and the future, period $t + 1$) is sufficient to think about dynamics, but considerably simplifies the analysis. Through the remainder of the book, we will focus on two period models. The key insights from two period models carry over to models with multiple future periods.

In the model, there is a representative household. There is no money in the model and everything is real (i.e. denominated in units of goods). The household earns income in the present and the future (for simplicity, we assume that future income is known with certainty, but can modify things so that there is uncertainty over the future). The household can save or borrow at some (real) interest rate r_t , which it takes as given. In period t , the household must choose how much to consume and how much to save. We will analyze the household's problem both algebraically using calculus and using an indifference curve - budget line diagram. The key insights from the model are as follows. First, how much the household wants to consume depends on both its current and its future income – i.e. the household is forward-looking. Second, if the household anticipates extra income in either the present or future, it will want to increase consumption in both periods – i.e. it desires to smooth its consumption relative to its income. The household smooths its consumption relative to its income by adjusting its saving behavior. This has the implication that the marginal propensity to consume (MPC) is positive but less than one – if the household gets extra income in the present, it will increase its consumption by a fraction of that, saving the rest. Third, there is an ambiguous effect of the interest rate on consumption – the substitution effect always makes the household want to consume less (save more) when the interest rate increases, but the income effect may go the other way. This being said, unless otherwise noted we shall assume that the substitution effect dominates, so that consumption is decreasing in the real interest rate. The ultimate outcome of these exercises is a consumption function, which is an optimal decision rule which relates optimal consumption to things the household takes as given – current income, future income, and the real interest rate. We will make use of the consumption function derived in this chapter throughout the rest of the book.

We conclude the chapter by consider several extensions to the two period framework. These include uncertainty about the future, the role of wealth, and borrowing constraints.

9.1 Model Setup

There is a single, representative household. This household lives for two periods, t (the present) and $t+1$ (the future). The consumption-saving problem is dynamic, so it is important that there be some future period, but it does not cost us much to restrict there to only be one future period. The household gets an exogenous stream of income in both the present and the future, which we denote by Y_t and Y_{t+1} . For simplicity, assume that the household enters period t with no wealth. In period t , it can either consume, C_t , or save, S_t , its income, with $S_t = Y_t - C_t$. Saving could be positive, zero, or negative (i.e. borrowing). If the household takes a stock of S_t into period $t + 1$, it gets $(1 + r_t)S_t$ units of additional income (or, in the case of borrowing, has to give up $(1 + r_t)S_t$ units of income). r_t is the real interest rate. Everything here is “real” and is denominated in units of goods.

The household faces a sequence of flow budget constraints – one constraint for each period. The budget constraints say that expenditure cannot exceed income in each period. Since the household lives for two periods, it faces two flow budget constraints. These are:

$$C_t + S_t \leq Y_t \tag{9.1}$$

$$C_{t+1} + S_{t+1} \leq Y_{t+1} + (1 + r_t)S_t. \tag{9.2}$$

The period t constraint, (9.1), says that consumption plus saving cannot exceed income. The period $t + 1$ constraint can be re-arranged to give:

$$C_{t+1} + S_{t+1} - S_t \leq Y_{t+1} + r_t S_t. \tag{9.3}$$

S_t is the *stock* of savings (with an “s” at the end) which the household takes from period t to $t + 1$. The *flow* of saving (without an “s” at the end) is the change in the stock of savings. Since we have assumed that the household begins life with no wealth, in period t there is no distinction between saving and savings. This is not true in period $t + 1$. S_{t+1} is the stock of savings the household takes from $t + 1$ to $t + 2$. $S_{t+1} - S_t$ is its saving in period $t + 1$ – the change in the stock. So (9.3) says that consumption plus saving ($C_{t+1} + S_{t+1} - S_t$) cannot exceed total income. Total income in period $t + 1$ has two components $-Y_{t+1}$, exogenous flow income, and interest income on the stock of savings brought into period t , $r_t S_t$ (which could be negative if the household borrowed in period t).

We can simplify these constraints in two dimensions. First, the weak inequality constraints

will hold with equality under conventional assumptions about preferences – the household will not let resources go to waste. Second, we know that $S_{t+1} = 0$. This is sometimes called a terminal condition. Why? S_{t+1} is the stock of savings the household takes into period $t + 2$. But there is no period $t + 2$ – the household doesn't live into period $t + 2$. The household would not want to finish with $S_{t+1} > 0$, because this would mean “dying” without having consumed all available resources. The household would want $S_{t+1} < 0$ – this would be tantamount to dying in debt. This would be desirable from the household's perspective because it would mean borrowing to finance more consumption while alive, without having to pay off the debt. We assume that the financial institution with which the household borrows and saves knows this and will not allow the household to die in debt. Hence, the best the household can do is to have $S_{t+1} = 0$. Hence, we can write the two flow budget constraints as:

$$C_t + S_t = Y_t \tag{9.4}$$

$$C_{t+1} = Y_{t+1} + (1 + r_t)S_t. \tag{9.5}$$

S_t shows up in both of these constraints. We can solve for S_t from one of the constraints and then plug it into the other. In particular, solving (9.5) for S_t :

$$S_t = \frac{C_{t+1}}{1 + r_t} - \frac{Y_{t+1}}{1 + r_t}. \tag{9.6}$$

Now, plug this into (9.4) and re-arrange terms. This yields:

$$C_t + \frac{C_{t+1}}{1 + r_t} = Y_t + \frac{Y_{t+1}}{1 + r_t}. \tag{9.7}$$

We refer to (9.7) as the intertemporal budget constraint. In words, it says that the present discounted value of the stream of consumption must equal the present discounted value of the stream of income. The present value of something is how much of that thing you would need in the present to have some value in the future. In particular, how many goods would you need in period t to have FV_{t+1} goods in period $t + 1$? Since you could put PV_t goods “in the bank” and get back $(1 + r_t)PV_t$ goods in the future, the $PV_t = \frac{FV_{t+1}}{1 + r_t}$. In other words, $\frac{C_{t+1}}{1 + r_t}$ is the present value of period $t + 1$ consumption and $\frac{Y_{t+1}}{1 + r_t}$ is the present value of period $t + 1$ income. The intertemporal budget constraint says that consumption must equal income in a present value sense. Consumption need not equal income each period.

Having discussed the household's budget constraints, we now turn to preferences. We assume that lifetime utility, U , is a weighted sum of flow utility from each period of life. In particular:

$$U = u(C_t) + \beta u(C_{t+1}), \quad 0 \leq \beta < 1. \quad (9.8)$$

Here, U refers to lifetime utility and is a number, denominated in utils. Utility is an ordinal concept, and so we don't need to worry about the absolute level of U . All that matters is that a higher value of U is “better” than a lower value. $u(\cdot)$ is a function which maps consumption into flow utility (so $u(C_t)$ is flow utility from period t consumption). β is a discount factor. We assume that it is positive but less than one. Assuming that it is less than one means that the household puts less weight on period $t + 1$ utility than period t utility. This means that we assume that the household is impatient – it would prefer utility in the present compared to the future. The bigger β is, the more patient the household is. We sometimes use the terminology that lifetime utility is the present value of the stream of utility flows. In this setup, β is the factor by which we discount future utility flows, in a way similar to how $\frac{1}{1+r_t}$ is the factor by which we discount future flows of goods. So sometimes we will say that β is the utility discount factor, while $\frac{1}{1+r_t}$ is the goods discount factor.¹ Finally, we assume that the function mapping consumption into flow utility is the same in periods t and $t + 1$. This need not be the case more generally, but is made for convenience.

We assume that the utility function has the following properties. First, $u'(\cdot) > 0$. We refer to $u'(\cdot)$ as the marginal utility of consumption. Assuming that this is positive just means that “more is better” – more consumption yields more utility. Second, we assume that $u''(C_t) < 0$. This says that there is diminishing marginal utility. As consumption gets higher, the marginal utility from more consumption gets smaller. Figure 9.1 plots a hypothetical utility function with these properties in the upper panel, and the marginal utility as a function of C_t in the lower panel.

Below are a couple of example utility functions:

$$u(C_t) = \theta C_t, \quad \theta > 0 \quad (9.9)$$

$$u(C_t) = C_t - \frac{\theta}{2} C_t^2, \quad \theta > 0 \quad (9.10)$$

$$u(C_t) = \ln C_t \quad (9.11)$$

$$u(C_t) = \frac{C_t^{1-\sigma} - 1}{1-\sigma} = \frac{C_t^{1-\sigma}}{1-\sigma} - \frac{1}{1-\sigma}, \quad \sigma > 0. \quad (9.12)$$

¹It is sometimes useful to use the terminology of discount *rates*, particularly if and when one is working in “continuous time” (we are working in “discrete time”). In particular, r_t is the goods discount rate and one over one plus this, i.e. $\frac{1}{1+r_t}$, is the goods discount factor. We could define ρ as the utility discount rate, implicitly defined by $\beta = \frac{1}{1+\rho}$. Assuming $0 < \beta < 1$ means assuming $\rho > 0$.

Figure 9.1: Utility and Marginal Utility

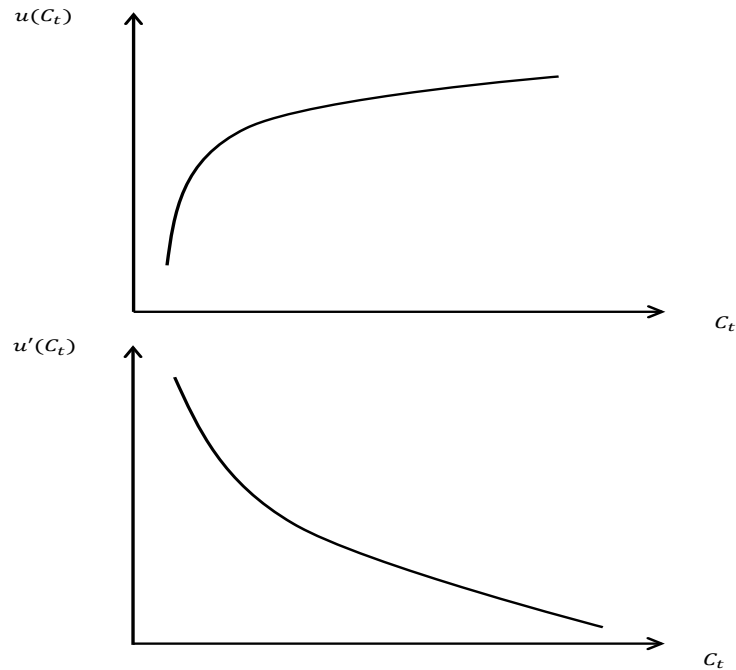

The utility function in (9.9) is a linear utility function. It features a positive marginal utility but the second derivative is zero, so this utility function does not exhibit diminishing marginal utility. The second utility function is called a quadratic utility function. It features diminishing marginal utility, but it does not always feature positive marginal utility – there exists a satiation point about which utility is decreasing in consumption. In particular, if $C_t > 1/\theta$, then marginal utility is negative. The third utility function is the log utility function. This utility function is particularly attractive because it is easy to take the derivative and it satisfies both properties laid out above. The final utility function is sometimes called the isoelastic utility function. It can be written either of the two ways shown in (9.12). Because utility is ordinal, it does not matter whether the $\frac{-1}{1-\sigma}$ is included or not. If $\sigma = 1$, then this utility function is equivalent to the log utility function. This can be shown formally using L'Hopital's rule. Note that nothing guarantees that utility is positive – if $C_t < 1$ in the log utility case, for example, then $u(C_t) < 0$. There is no problem with the level of utility being negative, since utility is ordinal. For example, suppose you are considering two values of consumption, $C_{1,t} = 0.9$ and $C_{2,t} = 0.95$. With the log utility function we have $\ln 0.9 = -0.1054$, which is negative. We have $\ln(0.95) = -0.0513$, which is also negative, but less negative than utility with $C_{1,t} = 0.9$. Hence, $C_{2,t}$ is preferred to $C_{1,t}$.

Mathematical Diversion

How can we show that the isoelastic utility function, (9.12), is equivalent to the

log utility function when $\sigma = 1$? If we evaluate (9.12) with $\sigma = 1$, we get $\frac{0}{0}$, which is undefined. L'Hopital's Rule can be applied. Formally, L'Hopital's rule says that if:

$$\lim_{x \rightarrow a} \frac{f(x)}{g(x)} = \frac{0}{0}, \quad (9.13)$$

where a is some number and x is the parameter of interest, then:

$$\lim_{x \rightarrow a} \frac{f(x)}{g(x)} = \lim_{x \rightarrow a} \frac{f'(x)}{g'(x)}. \quad (9.14)$$

In other words, we can evaluate the function as the ratio of the first derivatives evaluated at the point $x = a$. In terms of the isoelastic utility function, $x = \sigma$, $a = 1$, $f(x) = C^{1-\sigma} - 1$, and $g(x) = 1 - \sigma$. We can write $C^{1-\sigma} = \exp((1 - \sigma) \ln C_t)$. The derivative of this with respect to σ is:

$$\frac{d \exp((1 - \sigma) \ln C_t)}{d\sigma} = -\ln C_t \exp((1 - \sigma) \ln C_t). \quad (9.15)$$

In (9.15), $-\ln C_t$ is the derivative of the “inside” with respect to σ , and $\exp((1 - \sigma) \ln C_t)$ is the derivative of the “outside”. The derivative of $1 - \sigma$ with respect to σ is -1 . If we evaluate these derivatives at $\sigma = 1$, we get $-\ln C_t$ for the $f'(x_t)$ and -1 for $g'(x_t)$. The ratio is $\ln C_t$, meaning that as $\sigma \rightarrow 1$, the isoelastic utility function is simply the log utility function.

9.2 Optimization and the Euler Equation

The household faces an optimization problem in which it wants to pick C_t and S_t in period t to maximize lifetime utility, (9.8), subject to the two flow budget constraints, (9.4) and (9.5). We already know that S_t can be eliminated by combining the two flow budget constraints into the intertemporal budget constraint (9.7). We can then think about the problem as one in which the household chooses C_t and C_{t+1} in period t . Formally:

$$\max_{C_t, C_{t+1}} U = u(C_t) + \beta u(C_{t+1}) \quad (9.16)$$

subject to:

$$C_t + \frac{C_{t+1}}{1 + r_t} = Y_t + \frac{Y_{t+1}}{1 + r_t}. \quad (9.17)$$

This is a constrained optimization problem, with (9.17) summarizing the scarcity that the household faces. The household acts as a price-taker and takes r_t as given. To solve a constrained optimization problem, solve the constraint for one of the two choice variables (it does not matter which one). Solving for C_{t+1} , we get:

$$C_{t+1} = (1 + r_t)(Y_t - C_t) + Y_{t+1}. \quad (9.18)$$

Now, plug (9.18) into the lifetime utility function for C_{t+1} . This renders the problem of a household an unconstrained optimization problem of just choosing C_t :

$$\max_{C_t} U = u(C_t) + \beta u((1 + r_t)(Y_t - C_t) + Y_{t+1}). \quad (9.19)$$

To characterize optimal behavior, take the derivative with respect to C_t :

$$\frac{\partial U}{\partial C_t} = u'(C_t) + \beta u'((1 + r_t)(Y_t - C_t) + Y_{t+1}) \times -(1 + r_t). \quad (9.20)$$

In (9.20), the $u'((1 + r_t)(Y_t - C_t) + Y_{t+1})$ is the derivative of the “outside” part, while $-(1 + r_t)$ is the derivative of the “inside” with respect to C_t . The term inside $u'((1 + r_t)(Y_t - C_t) + Y_{t+1})$ is just C_{t+1} . Making that replacement, and setting the derivative equal to zero, yields:

$$u'(C_t) = \beta(1 + r_t)u'(C_{t+1}). \quad (9.21)$$

Expression (9.21) is commonly called the consumption *Euler equation*. In economics, we often call dynamic first order optimality conditions Euler equations. This condition is a necessary, though not sufficient, condition for the household optimization problem. It says that, at an optimum, the household should pick C_t and C_{t+1} so that the marginal utility of period t consumption, $u'(C_t)$, equals the marginal utility of period $t + 1$ consumption, $\beta u'(C_{t+1})$, multiplied by the gross real interest rate (i.e. one plus the real interest rate).

What is the intuition for why this condition must hold if the household is behaving optimally? Suppose that the household decides to consume a little bit more in period t . The marginal benefit of this is the extra utility derived from period t consumption, $u'(C_t)$. What is the marginal cost of consuming a little more in period t ? If the household is consuming a little more in t , it is saving a little less (equivalently, borrowing a little more). If it saves a little bit less in period t , this means it has to forego $1 + r_t$ units of consumption in $t + 1$ (since it has to pay back interest plus principle). The lost utility in period $t + 1$ from consuming a little less is $\beta u'(C_{t+1})$. The total loss in utility is this times the decline in consumption, so $\beta(1 + r_t)u'(C_{t+1})$ represents the marginal cost of consuming a little more in period t . At an optimum, the marginal benefit of consuming a little more in period t must equal the

marginal cost of doing so – if the marginal benefit exceeded the marginal cost, the household could increase lifetime utility by consuming more in t ; if the marginal benefit were less than the marginal cost, the household could increase lifetime utility by consuming a little less in period t .

The Euler equation, (9.21), can be re-arranged to be written:

$$\frac{u'(C_t)}{\beta u'(C_{t+1})} = 1 + r_t. \quad (9.22)$$

The left hand side of (9.22) is what is called the marginal rate of substitution (MRS) between period t and $t+1$ consumption. The MRS is simply the ratio of the marginal utilities of C_t and C_{t+1} . The right hand side is the price ratio between period t and period $t+1$ consumption. In particular, getting an additional unit of period t consumption requires giving up $1 + r_t$ units of $t+1$ consumption (via the logic laid out above). In this sense, we often refer to the real interest rate as the intertemporal price of consumption – r_t tells you how much future consumption one has to give up to get some more consumption in the present. At an optimum, the MRS is equal to the price ratio, which ought to be a familiar result to anyone who has taken intermediate microeconomics.

Example

Suppose that the utility function is the natural log. Then the Euler equation can be written:

$$\frac{1}{C_t} = \beta(1 + r_t) \frac{1}{C_{t+1}}. \quad (9.23)$$

This can be re-arranged:

$$\frac{C_{t+1}}{C_t} = \beta(1 + r_t). \quad (9.24)$$

The left hand side of (9.24) is the gross growth rate of consumption between t and $t+1$. Hence, the Euler equation identifies the expected growth rate of consumption as a function of the degree of impatience, β , and the real interest rate, r_t . It does not identify the levels of C_t and C_{t+1} – (9.24) could hold when C_t and C_{t+1} are both big or both small. Other factors held constant, the bigger is β , the higher will be expected consumption growth. Likewise, the bigger is r_t , the higher will be expected consumption growth. $\beta < 1$ means the household is impatient, which incentivizes consumption in the present at the expense of the future (i.e. makes C_{t+1}/C_t less than one, other things being equal). $r_t > 0$ has the opposite effect – it incentivizes deferring consumption to the future, which makes C_{t+1}/C_t greater than one. If $\beta(1 + r_t) = 1$, these two effects offset, and the

household will desire $C_{t+1} = C_t$.

Example

Suppose that the utility function is the isoelastic form, (9.12). Then the Euler equation can be written:

$$C_t^{-\sigma} = \beta(1 + r_t)C_{t+1}^{-\sigma}. \quad (9.25)$$

Take logs of (9.25), using the *approximation* that $\ln(1 + r_t) = r_t$:

$$-\sigma \ln C_t = \ln \beta + r_t - \sigma \ln C_{t+1}. \quad (9.26)$$

This can be re-arranged to yield:

$$\ln C_{t+1} - \ln C_t = \frac{1}{\sigma} \ln \beta + \frac{1}{\sigma} r_t. \quad (9.27)$$

Since $\ln C_{t+1} - \ln C_t$ is approximately the expected growth rate of consumption between t and $t + 1$, this says that consumption growth is positively related to the real interest rate. The coefficient governing the strength of this relationship is $1/\sigma$. The bigger is σ (loosely, the more concave is the utility function) the less sensitive consumption growth will be to changes in r_t , and vice-versa.

9.3 Indifference Curve / Budget Line Analysis and the Consumption Function

The Euler equation is a mathematical condition that is necessary if a household is behaving optimally. The Euler equation is *not* a consumption function, and it does not indicate how much consumption in the present and future a household should have if it is behaving optimally. The Euler equation only indicates how much *relative* consumption the household should do in the future versus the present, as a function of the real interest rate.

We would like to go further and determine the levels of period t and $t + 1$ consumption. In so doing, we will be able to discern some features of the consumption function. We will first proceed graphically, using an indifference curve / budget line diagram. The budget line is a graphical representation of the intertemporal budget constraint, (9.7). It graphically summarizes the scarcity inherited by the household. Let's consider a graph with C_{t+1} on the vertical axis and C_t on the horizontal axis. The budget line will show all combinations of C_t and C_{t+1} which exhaust resources – i.e. which make the intertemporal budget constraint

hold. Solving for C_{t+1} in terms of C_t :

$$C_{t+1} = (1 + r_t)(Y_t - C_t) + Y_{t+1}. \quad (9.28)$$

Given Y_t , Y_{t+1} , and r_t , the maximum period $t + 1$ the household can achieve is $C_{t+1} = (1 + r_t)Y_t + Y_{t+1}$. This level of consumption can be achieved if the household saves all of its period t income (consumption cannot be negative). Conversely, the maximum period t consumption the household can achieve is $C_t = Y_t + \frac{Y_{t+1}}{1+r_t}$. This involves consuming all of period t income and borrowing the maximum amount possible, $\frac{Y_{t+1}}{1+r_t}$, to finance period t consumption. $\frac{Y_{t+1}}{1+r_t}$ is the borrowing limit because this is the maximum amount the household can pay back in period t . These maximum levels of C_t and C_{t+1} form the horizontal and vertical axis intercepts of the budget line, respectively. The budget line must pass through the “endowment point” where $C_t = Y_t$ and $C_{t+1} = Y_{t+1}$. Consuming its income in each period is always feasible and completely exhausts resources. Finally, the slope of the budget line is $\frac{dC_{t+1}}{dC_t} = -(1 + r_t)$, which does not depend on C_t or C_{t+1} . Hence the budget line is in fact a line, because its slope is constant. Figure 9.2 plots a hypothetical budget line. Points inside the budget line are feasible but do not exhaust resources. Points beyond the budget line are infeasible.

Figure 9.2: Budget Line

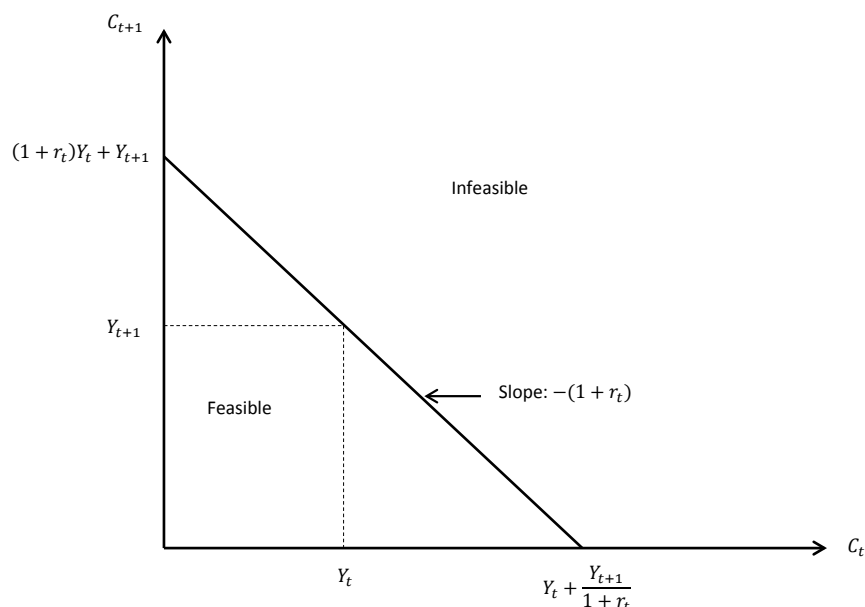

An indifference curve shows combinations of C_t and C_{t+1} (or “bundles” of period t and $t + 1$ consumption) which yield a fixed overall level of lifetime utility. There will be a different indifference curve for different levels of lifetime utility. In particular, suppose that a household

has a bundle $(C_{0,t}, C_{0,t+1})$ which yields overall utility level U_0 :

$$U_0 = u(C_{0,t}) + \beta u(C_{0,t+1}). \quad (9.29)$$

Consider simultaneous changes in C_t and C_{t+1} of dC_t and dC_{t+1} (these are changes relative to $C_{0,t}$ and $C_{0,t+1}$). Take the total derivative of (9.29):

$$dU = u'(C_{0,t})dC_t + \beta u'(C_{0,t+1})dC_{t+1}. \quad (9.30)$$

Since an indifference curve shows combinations of C_t and C_{t+1} which keep lifetime utility fixed, these hypothetical changes in C_t and C_{t+1} must leave $dU = 0$ (i.e. lifetime utility unchanged). Setting this equal to zero, and solving for $\frac{dC_{t+1}}{dC_t}$, we get:

$$\frac{dC_{t+1}}{dC_t} = -\frac{u'(C_{0,t})}{\beta u'(C_{0,t+1})}. \quad (9.31)$$

In other words, (9.31) says that the slope of the $U = U_0$ indifference curve at $(C_{0,t}, C_{0,t+1})$ is equal to the negative of the ratio of the marginal utilities of periods t and $t + 1$ consumption. Since both marginal utilities are positive, the slope of the indifference curve is negative. That the indifference curve is downward-sloping simply says that if the household increases period t consumption, it must decrease period $t + 1$ consumption if lifetime utility is to be held fixed. Given that we have assumed diminishing marginal utility, the indifference curve will have a “bowed in” shape, being steepest when C_t is small and flattest when C_t is big. If C_t is small, then the marginal utility of period t consumption is relatively high. Furthermore, if C_t is small and lifetime utility is held fixed, then C_{t+1} must be relatively big, so the marginal utility of period $t + 1$ consumption will be relatively small. Hence, the ratio of marginal utilities will be relatively large, so the the indifference curve will be steeply sloped. In contrast, if C_t is relatively big (and C_{t+1} small), then the marginal utility of period t consumption will be relatively small, while the marginal utility of period $t + 1$ consumption will be large. Hence, the ratio will be relatively small, and the indifference curve will be relatively flat.

Figure 9.3 plots some hypothetical indifference curves having this feature. Note that there is a different indifference curve for each conceivable level of lifetime utility. Higher levels of lifetime utility are associated with indifference curves that are to the northeast – hence, northeast is sometimes referred to as the “direction of increasing preference.” Indifference curves associated with different levels of lifetime utility cannot cross – this would represent a contradiction, since it would imply that the same bundle of periods t and $t + 1$ consumption yields two different levels of utility. Indifference curves need not necessarily be parallel to one another, however.

Figure 9.3: Indifference Curves

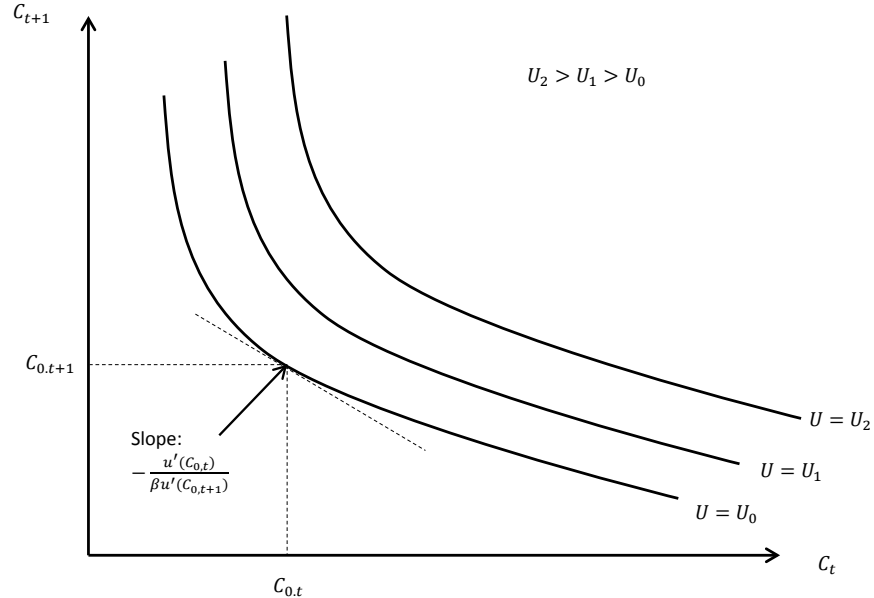

We can think about the household’s optimization problem as one of choosing C_t and C_{t+1} so as to locate on the “highest” possible indifference curve without violating the budget constraint. Figure 9.4 below shows how to think about this. There is a budget line and three different indifference curves, associated with utility levels $U_2 > U_1 > U_0$. Different possible consumption bundles are denoted with subscripts 0, 1, 2, or 3. Consider first the bundle labeled (0). This bundle is feasible (it is strictly inside the budget constraint), but the household could do better – it could increase C_t and C_{t+1} by a little bit, thereby locating on an indifference curve with a higher overall level of utility, while still remaining inside the budget constraint. Consumption bundle (1) lies on the same indifference curve as (0), and therefore yields the same overall lifetime utility. Consumption bundle (1) differs in that it lies on the budget constraint, and therefore exhausts available resources. Could consumption bundle (1) be the optimal consumption plan? No. (0) is also feasible and yields the same lifetime utility, but via the logic described above, the household could do better than (0) and hence better than bundle (1). The bundle labeled (2) is on the highest indifference curve shown, and is hence the preferred bundle by the household. But it is not feasible, as it lies completely outside of the budget line. If one were to continue iterating, what one finds is that consumption bundle (3) represents the highest possible indifference curve while not violating the budget constraint. This bundle occurs where the indifference curve just “kisses” the budget line – or, using formal terminology, it is tangent to it. Mathematically, at this point the indifference curve and the budget line are tangent, which means they have the same slope. Since the slope of the budget line is $-(1 + r_t)$, and the slope of the indifference curve

is $-\frac{u'(C_t)}{\beta u'(C_{t+1})}$, the tangency condition in this graph is no different than the Euler equation derived above.

Figure 9.4: An Optimal Consumption Bundle

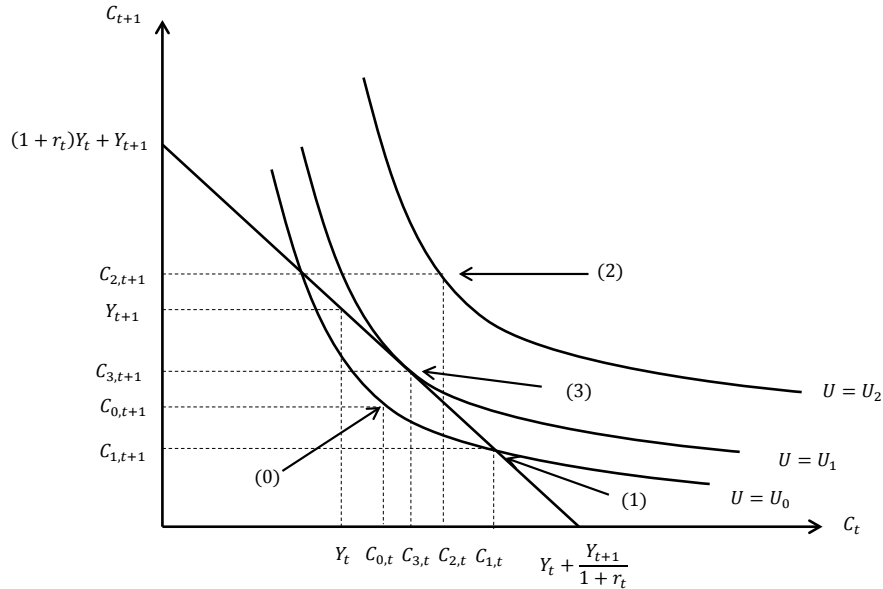

Having established that an optimal consumption bundle ought to occur where the indifference curve just kisses the budget line (i.e. the slopes are the same), we can use this to graphically analyze how the optimal consumption bundle ought to change in response to changes in things which the household takes as given. In particular, we will consider exogenous increases in Y_t , Y_{t+1} , or r_t . We will consider varying one of these variables at a time, holding the others fixed, although one could do exercises in which multiple variables exogenous to the household change simultaneously. In the text we will analyze the effects of increases in these variables; decreases will have similar effects but in the opposite direction.

Consider first an increase in current income, Y_t . Figure 9.5 analyzes this graphically. In the figure, we use a 0 subscript to denote the original situation and a 1 subscript to denote what happens after a change. In the figure, we suppose that the original consumption bundle features $C_{0,t} > Y_{0,t}$, so that the household is borrowing in the first period. Qualitatively, what happens to C_t and C_{t+1} is not affected by whether the household is saving or borrowing prior to the increase in current period income. Suppose that current income increases from $Y_{0,t}$ to $Y_{1,t}$. Nothing happens to future income or the real interest rate. With the endowment point on the budget line shifting out to the right, the entire budget line shifts out horizontally, with no change in the slope. This is shown with the blue line. The original consumption bundle, $(C_{0,t}, C_{0,t+1})$, now lies inside of the new budget line. This means that the household can locate on a higher indifference curve. In the new optimal consumption bundle, labeled

$(C_{1,t}, C_{1,t+1})$ and shown on the blue indifference curve, both current and future consumption are higher. We know that this must be the case because the slope of the indifference curve has to be the same at the new consumption bundle as at the original bundle, given that there has been no change in r_t and the indifference curve must be tangent to the budget line. If only C_t or only C_{t+1} increased in response to the increase in Y_t , the slope of the indifference curve would change. Similarly, if either C_t or C_{t+1} declined (rather than increased), the slope of the indifference curve would change.

Figure 9.5: Increase in Y_t

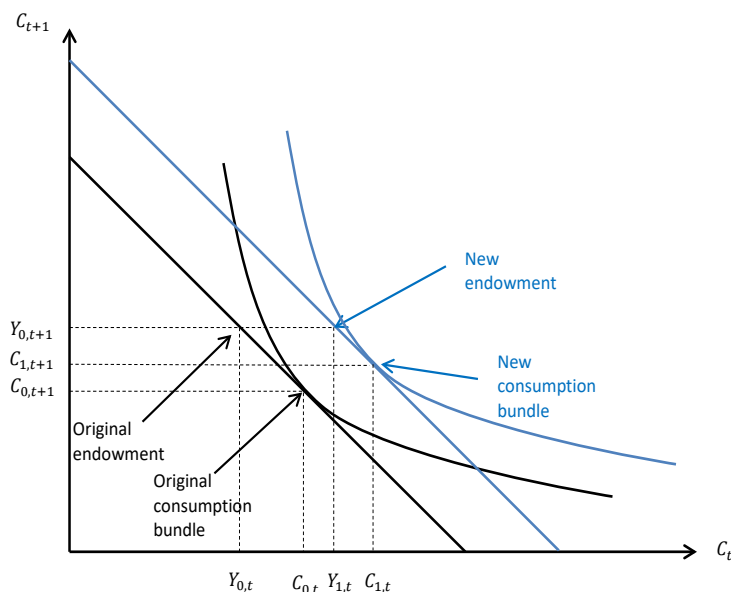

From this analysis we can conclude that C_t increases when Y_t increases. However, since C_{t+1} also increases, it must be the case that C_t increases by *less* than Y_t . Some of the extra income must be saved (equivalently, the household must decrease its borrowing) in order to finance more consumption in the future. This means that $0 < \frac{\partial C_t}{\partial Y_t} < 1$. An increase in Y_t , holding everything else fixed, results in a less than one-for-one increase in C_t . We often refer to the partial derivative of C_t with respect to current Y_t as the “marginal propensity to consume,” or MPC for short. This analysis tells us that the MPC ought to be positive but less than one.

In Figure 9.5 the household is originally borrowing, with $C_{0,t} > Y_{0,t}$, so $S_{0,t} < 0$. As we have drawn the figure, this is still the case in the new consumption bundle, so $S_{1,t} < 0$. However, graphically one can see that $S_{1,t} > S_{0,t}$ – the household is still borrowing, but is borrowing less. This is a natural consequence of the analysis above that shows that S_t must increase in response to an increase in Y_t – the household consumes some of the extra income and saves the rest, so saving goes up. If the increase in income is sufficiently big, the household could

switch from borrowing to saving, with $S_{1,t} > 0$. We have not drawn the figure this way, but it is a possibility.

Consider next an increase in Y_{t+1} , holding everything else fixed. The effects are shown in Figure 9.6. The increase in Y_{t+1} from $Y_{0,t+1}$ to $Y_{1,t+1}$ pushes the endowment point up. Since the new budget line must pass through this point, but there has been no change in r_t , the budget line shifts out horizontally in a way similar to what is shown in Figure 9.5.

Figure 9.6: Increase in Y_{t+1}

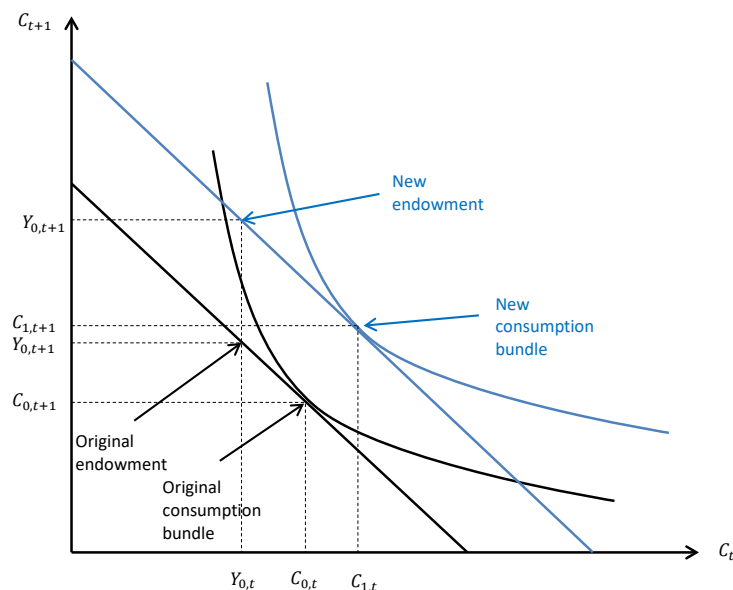

As in the case of an increase in Y_t , following an increase in Y_{t+1} the original consumption bundle now lies inside the new budget line. The household can do better by locating on an indifference curve like the one shown in blue. In this new consumption bundle, both current and future consumption increase. This means that saving, $S_t = Y_t - C_t$, decreases (equivalently, borrowing increases), because there is no change in current income.

The results derived graphically in Figures 9.5 and 9.6 reveal an important result. A household would like to *smooth* its consumption relative to its income. Whenever income increases (or is expected to increase), the household would like to increase consumption in *all periods*. The household can smooth its consumption by adjusting its saving behavior. In response to an increase in current income, the household saves more (or borrows less) to finance more consumption in the future. In response to an anticipated increase in future income, the household saves less (or borrows more), allowing it to increase consumption in the present. The household's desire to smooth consumption is hard-wired into our assumptions on preferences. It is a consequence of the assumption of diminishing marginal utility, mathematically characterized by the assumption that $u''(\cdot) < 0$. With $u''(\cdot) < 0$, the

household would prefer to increase consumption by a little bit in both periods in response to a change in income (regardless of the period in which that income increase occurs), as opposed to increasing consumption by a lot only in the period in which that increase in income occurs. The example below makes this clear.

Example

Suppose that the utility function is $u(C_t) = \sqrt{C_t}$. Suppose further that $\beta = 1$ and $r_t = 0$ (both of which substantially simplify the analysis). The Euler equation is then $0.5C_t^{-0.5} = 0.5C_{t+1}^{-0.5}$, which requires that $C_t = C_{t+1}$. Suppose that, originally, $Y_t = Y_{t+1} = 1$. Combining the Euler equation with the intertemporal budget constraint (with $\beta = 1$ and $r_t = 0$) then means that $C_t = 0.5$ and $C_{t+1} = 0.5$ is the optimal consumption bundle. Lifetime utility is 1.4142. Suppose that current income increases to 2. If the household chooses to spend all of the additional income in period t (so that $C_t = 1.5$ and $C_{t+1} = 0.5$), then lifetime utility increases to 1.9319. If the household chooses to save all of the additional income, spending it all in the next period (so that $C_t = 0.5$ and $C_{t+1} = 1.5$), then lifetime utility also increases to 1.9319. If, instead, the household increases consumption by 0.5 in both periods, saving 0.5 more in period t , then lifetime utility increases to 2. This is better than either of the outcomes where consumption only adjusts in one period or the other.

Next, consider the effects of an increase in the interest rate, r_t . Because this ends up being a bit messier than a change in Y_t or Y_{t+1} , it is easier to begin by focusing on just how the budget line changes in response to a change in r_t . Consider first the budget line associated with $r_{0,t}$, shown in black below. Next consider an increase in the interest rate to $r_{1,t}$. The budget line always must always pass through the endowment point, which is unchanged. A higher interest rate reduces the maximum period t consumption the household can do (because it can borrow less), while it increases the maximum period $t + 1$ consumption the household can do (because it can earn more on saving). These changes have the effect of “pivoting” the new budget line (shown in blue) through the endowment point, with the horizontal axis intercept smaller and the vertical axis bigger. The slope of the new budget line is steeper. Effectively, the budget line shifts inward in the region where $C_t > Y_t$ and outward in the region where $C_t < Y_t$.

Figure 9.7: Increase in r_t and Pivot of the Budget Line

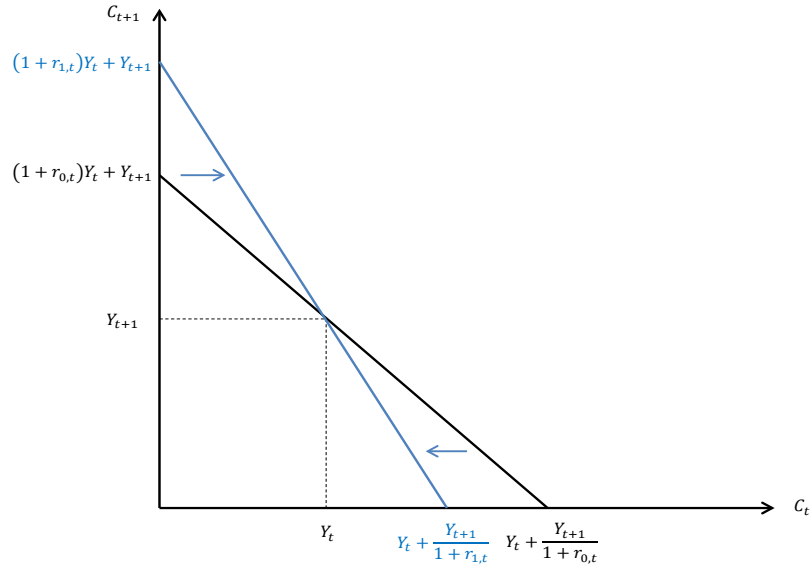

Now, let us consider how an increase in r_t affects the optimal consumption choices of a household. To do this, we need to use the tools of income and substitution effects, and it matters initially whether the household is borrowing (i.e. $C_t > Y_t$) or saving (i.e. $C_t < Y_t$). Consider first the case where the consumer is initially borrowing. This is shown below in Figure 9.8. The initial consumption bundle is $C_{0,t}$ and $C_{0,t+1}$, and the household locates on the black indifference curve.

Figure 9.8: Increase in r_t : Initially a Borrower

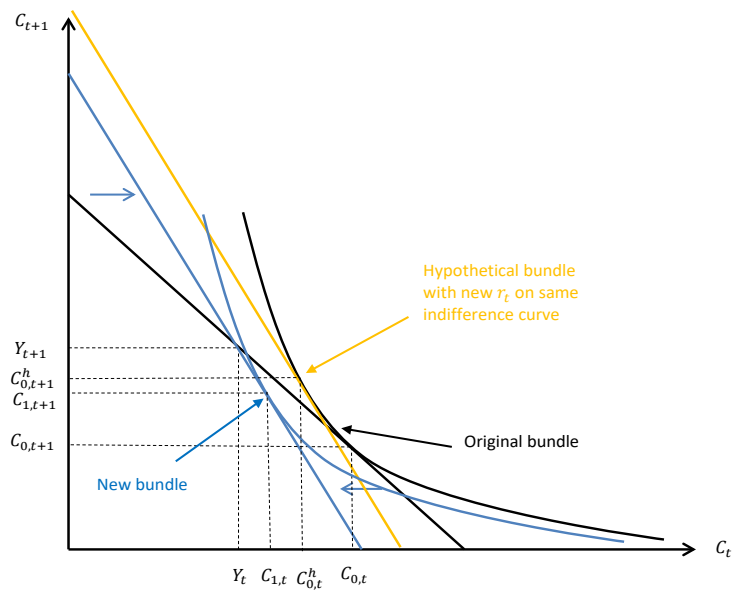

The increase in r_t causes the budget line to pivot through the endowment point, and is shown in the diagram in blue. To think about how this impacts the consumption bundle, it is useful to consider a hypothetical budget line which has the same slope as the new budget line (i.e. the slope given by the new, higher r_t), but is positioned in such a way that the household would choose to locate on the original indifference curve. The hypothetical budget line is shown in the diagram in orange. Since this hypothetical budget line is steeper, but allows the household to achieve the same lifetime utility, the household must choose a hypothetical consumption bundle with lower current consumption and higher future consumption. This hypothetical consumption bundle is labeled $C_{0,t}^h$ and $C_{0,t+1}^h$. The movement to this hypothetical budget line represents what we call the substitution effect – it shows how the consumption bundle would change after a change in the interest rate, where the household is compensated with sufficient income so as to leave lifetime utility unchanged. The substitution effect has the household substitute away from the relatively more expensive good (period t consumption) and into the relatively cheaper good (period $t + 1$ consumption).

This is not the only effect at play, however. This hypothetical budget line which allows the household to achieve the same lifetime utility level is unattainable – it lies everywhere outside of the actual new budget line, given in blue. The income effect is the movement from the hypothetical bundle with a higher r_t but unchanged lifetime utility to a new indifference curve tangent to the new budget line, both shown in blue. The income effect in this diagram looks similar to what was shown above for a change in Y_t or Y_{t+1} – the household reduces, relative to the hypothetical consumption bundle, consumption in both periods. The new consumption bundle is labeled $(C_{1,t}, C_{1,t+1})$. Since both the substitution and income effects go in the same direction for period t consumption (i.e. reduce it), C_t definitely falls when r_t increases. Though the picture is drawn where C_{t+1} rises, in principle this effect is ambiguous – the substitution effect says to increase C_{t+1} , whereas the income effect is to reduce it. Which dominates is unclear in general.

The intuitive way to think about the competing income and substitution effects is as follows. As noted earlier, we can think of r_t as the intertemporal price of consumption. When r_t goes up, current consumption becomes expensive relative to future consumption. Holding income fixed, the household would shift away from current consumption and into future consumption. But there is an income effect. Since the household is originally borrowing, an increase in r_t increases the cost of borrowing. This is like a reduction in its future income – for a given amount of current borrowing, the household will have less future income available after paying off its debt. A reduction in future income makes the household want to reduce consumption in both periods. Since income and substitution effects go in the same direction for period t consumption, we can conclude that C_t falls when r_t increases if the household is

originally borrowing. But we cannot say with certainty what the total effect is for a saver.

Let's now consider the case of a saver formally. Figure 9.9 shows the case graphically. Initially the household locates at $(C_{0,t}, C_{0,t+1})$, where $C_{0,t} < Y_t$. The increase in r_t causes the budget line to pivot through the endowment point, shown in blue.

Figure 9.9: Increase in r_t : Initially a Saver

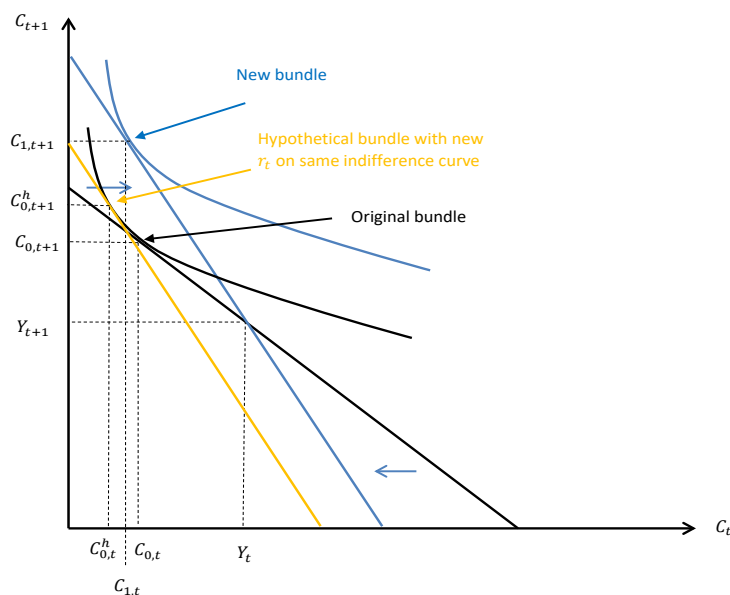

Let's again use a hypothetical budget line with the new slope given by the new higher r_t but shifted such that the household would locate on the original indifference curve. This is shown in orange. In this hypothetical situation, the household would reduce C_t but increase C_{t+1} . To determine the total effect on consumption, we need to think of how the household would move from the hypothetical budget line to the actual new budget line. The hypothetical orange budget line lies everywhere inside of the actual new budget line. This means that the both period t and period $t + 1$ consumption will increase, relative to the hypothetical case, when moving to the actual new budget line. This is the income effect. The income and substitution effects go in the same direction for period $t + 1$ consumption, meaning that we can determine that C_{t+1} definitely increases. The income effect has period t consumption increasing, in contrast to the substitution effect, which features C_t falling. Hence, the total effect on period t consumption is theoretically ambiguous.

The intuition for these effects is similar to above. If the household is originally saving, a higher r_t means that it will earn a higher return on that saving. For a given amount of current saving, a higher r_t would generate more available income to spend in period $t + 1$ after earning interest. This is like having more future income, which makes the household

want to consume more in both periods. This is the income effect, which for the case of period t consumption works opposite the substitution effect.

Table 9.1 summarizes the qualitative effects of an increase in r_t on C_t and C_{t+1} , broken down by income and substitution effects. “+” means that the variable in question goes up when r_t goes up, and “-” signs mean that the variable goes down. The substitution effect does not depend on whether the household is initially borrowing or saving – C_t decreases and C_{t+1} increases when r_t goes up. The income effect depends on whether the household is originally borrowing or saving. The total effect is the sum of the income and substitution effects.

Table 9.1: Income and Substitution Effects of Higher r_t

	Substitution Effect	Income Effect	Total Effect
C_t			
Borrower	-	-	-
Saver	-	+	?
C_{t+1}			
Borrower	+	-	?
Saver	+	+	+

From here on out, unless otherwise noted, we will *assume that the substitution effect dominates the income effect*. This means that the sign of the total effect of an increase in r_t is driven by the substitution effect. This seems to be the empirically relevant case. This means that we assume that, when r_t increases, C_t goes down while C_{t+1} goes up, regardless of whether the household is initially borrowing or saving.

From this graphical analysis, we can conclude that there exists a consumption function which maps the things which the household takes as given – Y_t , Y_{t+1} , and r_t – into the optimal level of current consumption, C_t . We will denote this consumption function by:

$$C_t = C^d(Y_t, Y_{t+1}, r_t). \quad (9.32)$$

Here $C^d(\cdot)$ is a function mapping current and future income and the real interest rate into the current level of consumption. In (9.32), the “+” and “-” signs under each argument of the consumption function denote the signs of the partial derivatives; e.g. $\frac{\partial C^d(\cdot)}{\partial Y_t} > 0$. The partial derivative with respect to r_t is negative under the assumption that the substitution effect dominates the income effect. As noted, we refer to the partial derivative with respect to current income as the marginal propensity to consume, or MPC.

(9.32) is qualitative. To get an explicit expression for the consumption function, we would

need to make a functional form on the utility function, $u(\cdot)$. We can think about the Euler equation as providing one equation in two unknowns (C_t and C_{t+1}). The intertemporal budget constraint is another equation in two unknowns. One can combine the Euler equation with the intertemporal budget constraint to solve for an analytic expression for the consumption function.

Suppose that the flow utility function is the natural log, so $u(C_t) = \ln C_t$. Then the Euler equation tells us that $C_{t+1} = \beta(1 + r_t)C_t$. Take this expression for C_{t+1} and plug it into the intertemporal budget constraint, which leaves just C_t on the left hand side. Simplifying, one gets:

$$C_t = \frac{1}{1 + \beta} \left[Y_t + \frac{Y_{t+1}}{1 + r_t} \right]. \quad (9.33)$$

(9.33) is the consumption function for log utility. We can calculate the partial derivatives of C_t with respect to each argument on the right hand side as follows:

$$\frac{\partial C_t}{\partial Y_t} = \frac{1}{1 + \beta} \quad (9.34)$$

$$\frac{\partial C_t}{\partial Y_{t+1}} = \frac{1}{1 + \beta} \frac{1}{1 + r_t} \quad (9.35)$$

$$\frac{\partial C_t}{\partial r_t} = -\frac{Y_{t+1}}{1 + \beta} (1 + r_t)^{-2}. \quad (9.36)$$

The MPC is equal to $\frac{1}{1 + \beta}$, which is between 0 and 1 since β is between 0 and 1. The closer β is to zero (i.e. the more impatient the household is), the closer is the MPC to 1. For this particular functional form, the MPC is just a number and is independent of the level of current income. This will not necessarily be true for other utility functions, though throughout the course we will often treat the MPC as a fixed number independent of the level of income for tractability. The partial derivative with respect to future income, (9.35), is positive, as predicted from our indifference curve / budget line analysis. Note that r_t could potentially be negative, but it can never be less than -1 . If it were less than this, saving a unit of goods would entail paying back more goods in the future, which no household would ever take. If the real interest rate is negative but greater than -1 , this would mean that saving a unit of goods would entail getting back less than one unit of goods in the future; the household may be willing to accept this if it cannot otherwise store its income across time. For the more likely case in which $r_t > 0$, the partial derivative of period t consumption with respect to future income is positive but less than the partial with respect to current income. Finally, the partial derivative with respect to the real interest rate is less than or equal to zero. It would be equal to zero in the case in which $Y_{t+1} = 0$. In this case, with no future income the household would choose to save in the first period, and for this particular specification of

preferences the income and substitution effects would exactly cancel out. Otherwise, as long as $Y_{t+1} > 0$, the substitution effect dominates, and current consumption is decreasing in the real interest rate.

With the log utility function, the consumption function takes a particularly simple form which has a very intuitive interpretation. In particular, looking at (9.33), one sees current consumption is simply proportional to the present discounted value of the stream of income. The present discounted value of the stream of income is $Y_t + \frac{Y_{t+1}}{1+r_t}$, while the proportionality constant is $\frac{1}{1+\beta}$. An increase in either Y_t or Y_{t+1} increases the present value of the stream of income, the increase in Y_t by more than the increase in Y_{t+1} if $r_t > 0$. An increase in r_t reduces the present discounted value of the stream of income so long as $Y_{t+1} > 0$, because future income flows get more heavily discounted. Thinking of current consumption as proportional to the present discounted value of the stream of income is a very useful way to think about consumption-saving behavior, even though the consumption function only works out explicitly like this for this particular log utility specification.

9.4 Extensions of the Two Period Consumption-Saving Model

9.4.1 Wealth

In our baseline analysis, we assumed two things: (i) the household begins period t with no stock of wealth and (ii) there is only one asset with which the household can transfer resources across time, the stock of which we denote with S_t . In this subsection we relax both of these assumptions.

In particular, suppose that the household begins life with with an exogenous stock of wealth, H_{t-1} . You could think about this as a quantity of housing or shares of stock. Suppose that the period t price of this asset (denominated in units of goods) is Q_t , which the household takes as given. The household can accumulate an additional stock of this wealth to take into period $t + 1$, which we denote with H_t . The period t budget constraint is:

$$C_t + S_t + Q_t H_t \leq Y_t + Q_t H_{t-1} \quad (9.37)$$

This budget constraint can equivalently be written:

$$C_t + S_t + Q_t (H_t - H_{t-1}) \leq Y_t \quad (9.38)$$

In (9.38), the household has some exogenous income in period t , Y_t . It can consume, C_t , buy bonds, S_t , or buy/sell some of the other asset at price Q_t , where $H_t - H_{t-1}$ is the change in the stock of this asset.

The period $t + 1$ budget constraint can be written:

$$C_{t+1} + S_{t+1} + Q_{t+1} (H_{t+1} - H_t) \leq Y_{t+1} + (1 + r_t)S_t \quad (9.39)$$

In (9.39), the household has exogenous income in period $t + 1$, Y_{t+1} , and gets interest plus principal on its savings it brought into period $t + 1$, $(1 + r_t)S_t$. It can consume, accumulate more savings, or accumulate more of the other asset, H_{t+1} . Since there is no period $t + 2$, the terminal conditions will be that $S_{t+1} = H_{t+1} = 0$ – the household will not want to leave any wealth (either in the form of S_{t+1} or H_{t+1}) over for a period in which it does not live. This means that the second period budget constraint can be re-written:

$$C_{t+1} \leq Y_{t+1} + (1 + r_t)S_t + Q_{t+1}H_t \quad (9.40)$$

If we assume that (9.40) holds with equality, we can solve for S_t as:

$$S_t = \frac{C_{t+1}}{1 + r_t} - \frac{Y_{t+1}}{1 + r_t} - \frac{Q_{t+1}H_t}{1 + r_t} \quad (9.41)$$

Now, plugging this into (9.38), where we also assume that it holds with equality, yields:

$$C_t + \frac{C_{t+1}}{1 + r_t} + Q_t H_t = Y_t + \frac{Y_{t+1}}{1 + r_t} + Q_t H_{t-1} + \frac{Q_{t+1}H_t}{1 + r_t} \quad (9.42)$$

This is the modified intertemporal budget constraint. It reduces to (9.7) in the special case that H_t and H_{t-1} are set to zero. The left hand side is the present discounted value of the stream of expenditure – $C_t + \frac{C_{t+1}}{1+r_t}$ is the present discounted value of the stream of consumption, while $Q_t H_t$ is the present discounted value expenditure on the asset, H_t (i.e. purchases in period t of the asset). On the right hand side, we have the present discounted value of the stream of income, $Y_t + \frac{Y_{t+1}}{1+r_t}$, plus the existing value of the asset, $Q_t H_{t-1}$, plus the present discounted value of the asset in period $t + 1$, $\frac{Q_{t+1}H_{t+1}}{1+r_t}$. Effectively, we can think about the situation like this. The household begins life with H_{t-1} of the asset, which it sells at price Q_t . It then decides how much of the asset to buy to take into the next period, which is also buys at Q_t . Hence, $Q_t H_{t-1}$ is income in period t and $Q_t H_t$ is expenditure on the asset in period t . Then, the household sells off whatever value of the asset it has left in period $t + 1$ at price Q_{t+1} . The present value of this is $\frac{Q_{t+1}H_t}{1+r_t}$.

In general, the household gets to optimally choose how much of the asset to take into period $t + 1$. In other words, it gets to choose H_t , and there would be a first order condition for this, in many ways similar to the Euler equation for consumption. Because we are focused on consumption here, to simplify matters let us assume that the household must choose $H_t = 0$ – in other words, the household simply sells off all of its asset in period t , and doesn't take

any of the asset into period $t + 1$. In this case, the modified intertemporal budget constraint reduces to:

$$C_t + \frac{C_{t+1}}{1 + r_t} = Y_t + \frac{Y_{t+1}}{1 + r_t} + Q_t H_{t-1} \quad (9.43)$$

In this case, we can think about $Q_t H_{t-1}$ as simply representing exogenous income for the household. The consumption Euler equation is unaffected by the presence of this term in the intertemporal budget constraint, but it does affect the budget line. In particular, we can think about the endowment point for the budget line as being $Y_t + Q_t H_{t-1}$ in period t , and Y_{t+1} in period $t + 1$. Let us analyze how an increase in Q_t ought to impact consumption and saving behavior using an indifference curve / budget line diagram.

Suppose that initially the consumer has income of $Y_{0,t}$ in period t and $Y_{0,t+1}$ in period $t + 1$. The consumer is endowed with H_{t-1} units of the asset and the original price of the asset is $Q_{0,t}$. Suppose that the consumer initially chooses a consumption bundle $C_{0,t}, C_{0,t+1}$, shown at the tangency of the black indifference curve with the black budget line in Figure 9.10.

Figure 9.10: Increase in Q_t

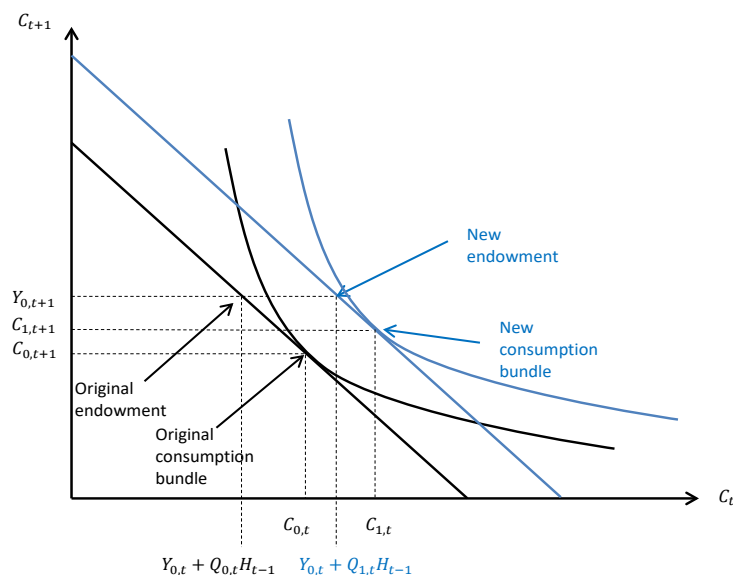

Suppose that there is an exogenous increase in Q_t to $Q_{1,t} > Q_{0,t}$. This has the effect of increasing the period t endowment point, which causes the entire budget line to shift to the right. The consumer will locate on the new, blue budget line at a consumption bundle $C_{1,t}, C_{1,t+1}$, where both period t and $t + 1$ consumption are higher. These effects are similar to what happens after an increase in current income. The household will increase its current saving, S_t .

Empirical Evidence

This situation is similar to the stock market boom of the 1990s.

There is an alternative way to think about this model. Suppose that the household enters period t with no stock of the asset, so $H_{t-1} = 0$. Suppose further that the household has to purchase an exogenous amount of the asset to take into the next period, H_t . One can think about this situation as the household being required to purchase a house to live in, which it will sell off after period $t + 1$. In this case, the intertemporal budget constraint becomes:

$$C_t + \frac{C_{t+1}}{1+r_t} + Q_t H_t = Y_t + \frac{Y_{t+1}}{1+r_t} + \frac{Q_{t+1} H_t}{1+r_t} \quad (9.44)$$

This can be re-written:

$$C_t + \frac{C_{t+1}}{1+r_t} = Y_t + \frac{Y_{t+1}}{1+r_t} + H_t \left(\frac{Q_{t+1}}{1+r_t} - Q_t \right) \quad (9.45)$$

We can think about the current endowment point as being given by $Y_t - Q_t H_t$, since $Q_t H_t$ is required, exogenous expenditure. The future endowment point is $Y_{t+1} + Q_{t+1} H_t$. Suppose that initially the household has income $Y_{0,t}$ and $Y_{0,t+1}$, and the future price of the asset is $Q_{0,t+1}$. This is shown in Figure 9.11. The household chooses an initial consumption bundle of $C_{0,t}, C_{0,t+1}$. Suppose that there is an anticipated increase in the future price of the asset, to $Q_{1,t+1} > Q_{0,t+1}$. This effectively raises the future endowment of income, which causes the budget line to shift outward, shown in blue. The household will choose a new consumption bundle, $C_{1,t}, C_{1,t+1}$, where both period t and period $t + 1$ consumption are higher. Graphically, the effects here are similar to what happens when there is an exogenous increase in future income. The household will reduce its current saving.

Figure 9.11: Increase in Q_{t+1}

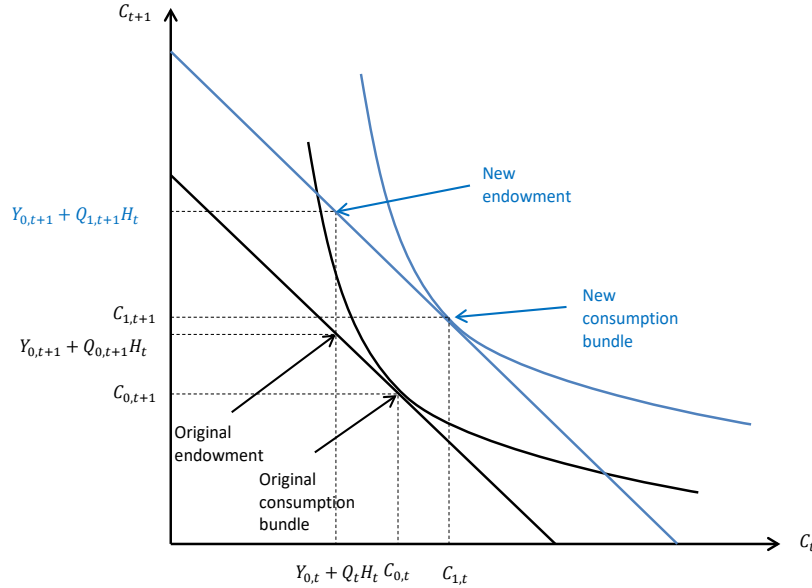

Empirical Evidence

This setup is similar to the housing boom of the mid-2000s. Households expected future increases in house prices. This caused them to expand consumption and reduce saving. When the future increase in house prices didn't materialize, consumption collapsed, which helped account for the Great Recession.

The analysis in this subsection is greatly simplified in that we have ignored the fact that the household can choose H_t in reality. When H_t can be chosen, the effects get more complicated. But the general gist is that *wealth*, broadly defined, is something which ought to impact consumption behavior. We have documented two recent examples where wealth, housing wealth or stock market wealth, have played an important role in driving consumption behavior.

9.4.2 Permanent and Transitory Income Changes

In the analysis above, we have examined the partial derivatives of consumption with respect to current and future income. Partial derivatives hold everything else fixed. So when we talk about the partial effect of an increase in Y_t on C_t , we are holding Y_{t+1} fixed. While this is a valid exercise in the context of the model, it does not necessarily correspond with what we know about changes in income in the data. In particular, changes in income empirically tend to be quite persistent in the sense that higher current income tends to be

positively correlated with higher future income. A bonus would be an example of a one time change in income. But when you get a raise, this is often factored into future salaries as well.

Consider the qualitative consumption function derived above, (9.32). Totally differentiate this about some point:

$$dC_t = \frac{\partial C^d(\cdot)}{\partial Y_t} dY_t + \frac{\partial C^d(\cdot)}{\partial Y_{t+1}} dY_{t+1} + \frac{\partial C^d(\cdot)}{\partial r_t} dr_t \quad (9.46)$$

In words, (9.46) says that the total change in consumption is (approximately) the sum of the partial derivatives times the change in each argument. Let's consider holding the real interest rate fixed, so $dr_t = 0$. Consider what we will call a transitory change in income, so that $dY_t > 0$ but $dY_{t+1} = 0$ – i.e., income only changes in the current period. Then the change in consumption divided by the change in income is just equal to the MPC, $\frac{\partial C(\cdot)}{\partial Y_t}$:

$$\frac{dC_t}{dY_t} = \frac{\partial C^d(\cdot)}{\partial Y_t} \quad (9.47)$$

Next, consider what we will call a permanent change in income, where $dY_t > 0$ and $dY_{t+1} = dY_t$ – i.e. income goes up by the same amount in both periods. The change in consumption divided by the change in income in this case is given by the sum of the partial derivatives of the consumption function with respect to the first two arguments:

$$\frac{dC_t}{dY_t} = \frac{\partial C^d(\cdot)}{\partial Y_t} + \frac{\partial C^d(\cdot)}{\partial Y_{t+1}} \quad (9.48)$$

Since both of these partial derivatives are positive, (9.48) reveals that consumption will react *more* to a permanent change in income than to a transitory change in income. This means that saving will increase by less to a permanent change in income than to a transitory change in income. This result is a natural consequence of the household's desire to smooth consumption relative to income. If the household gets a one time increase in income in period t , income is relatively non-smooth across time. To smooth consumption relative to income, the household needs to increase its saving in period t , so as to be able to increase consumption as well in the future. But if income goes up in both periods, the household doesn't need to adjust its saving as much, because it will have extra income in the future to support extra consumption. Hence, saving will go up by less, and consumption more, to a permanent change in income.

Example

Suppose that the utility function is log, so that the consumption function is given by (9.33). For simplicity, assume that $\beta = 1$ and $r_t = 0$. From the Euler equation, this means that the household wants $C_t = C_{t+1}$. The intertemporal

budget constraint with these restrictions just says that the sum of consumption is equal to the sum of income. Combining these two together, we get:

$$C_t = \frac{1}{2} (Y_t + Y_{t+1}) \quad (9.49)$$

In other words, with log utility, $\beta = 1$, and $r_t = 0$, consumption is just equal to average income across periods. The MPC for this consumption function is $\frac{1}{2}$. But if there is a permanent change in income, with Y_t and Y_{t+1} both going up by the same amount, then average income goes up by the same amount, and hence consumption will go up by the amount of the increase in income – i.e. $\frac{dC_t}{dY_t} = 1$. In other words, with this setup, a household will consume half and save half of a transitory change in income, but it will consume all of a permanent change in income, with no adjustment to its saving behavior.

These results about the differential effects of permanent and transitory changes in income on consumption have important implications for empirical work. For a variety of different reasons, the magnitude of the MPC is an object of interest to policy makers. One would be tempted to conclude that one could identify the MPC by looking at how consumption reacts to changes in income. This would deliver the correct value of the MPC, but only in the case that the change in income under consideration is transitory. If the change in income is persistent, consumption will react by more than the MPC. If one isn't careful, one could easily over-estimate the MPC.

9.4.3 Taxes

Let us augment the the basic model to include a situation where the household must pay taxes to a government. In particular, assume that the household has to pay T_t and T_{t+1} to the government in periods t and $t + 1$, respectively. The two flow budget constraints can be written:

$$C_t + S_t \leq Y_t - T_t \quad (9.50)$$

$$C_{t+1} + S_{t+1} \leq Y_{t+1} - T_{t+1} + (1 + r_t)S_t \quad (9.51)$$

Imposing the terminal condition that $S_{t+1} = 0$, and assuming that these constraints hold with equality, gives the modified intertemporal budget constraint:

$$C_t + \frac{C_{t+1}}{1+r_t} = Y_t - T_t + \frac{Y_{t+1} - T_{t+1}}{1+r_t} \quad (9.52)$$

(9.52) is similar to (9.7), except that income net of taxes, $Y_t - T_t$ and $Y_{t+1} - T_{t+1}$, appear on the right hand side. The Euler equation is identical. Functionally, changes in T_t or T_{t+1} operate exactly the same as changes in Y_t or Y_{t+1} . We can write a modified consumption function as:

$$C_t = C^d(Y_t - T_t, Y_{t+1} - T_{t+1}, r_t) \quad (9.53)$$

Consider two different tax changes, one transitory, $dT_t \neq 0$ and $dT_{t+1} = 0$, and one permanent, where $dT_t \neq 0$ and $dT_{t+1} = dT_t$. Using the total derivative terminology from Section 9.4.2, we can see that the effect of a transitory change in taxes is:

$$\frac{dC_t}{dT_t} = -\frac{\partial C^d(\cdot)}{\partial Y_t} \quad (9.54)$$

While the effect of a permanent tax change is:

$$\frac{dC_t}{dT_t} = -\left[\frac{\partial C^d(\cdot)}{\partial Y_t} + \frac{\partial C^d(\cdot)}{\partial Y_{t+1}} \right] \quad (9.55)$$

Here, $\frac{\partial C^d(\cdot)}{\partial Y_t}$ is understood to refer to the partial derivative of the consumption function with respect to the first argument, $Y_t - T_t$. Since T_t enters this negatively, this is why the negative signs appear in (9.54) and (9.55). The conclusion here is similar to our conclusion about the effects of permanent and transitory income changes. Consumption ought to react more to a permanent change in taxes than a transitory change in taxes.

Empirical Evidence

There are two well-known empirical papers on the consumption responses to tax changes. [Shapiro and Slemrod \(2003\)](#) study the responses of planned consumption expenditures to the Bush tax cuts in 2001. Most households received rebate checks of either \$300 or \$600, depending on filing status. These rebates were perceived to be nearly permanent, being the first installment of a ten year plan (which was later extended). Our theory suggests that households should have spent a significant fraction of these tax rebates, given their near permanent nature. [Shapiro and Slemrod \(2003\)](#) do not find this. In particular, in a survey only 22 percent of households said that they planned to spend their tax rebate checks. This is inconsistent with the basic predictions of the theory as laid out in this chapter.

The same authors conducted a follow up study using a similar methodology. [Shapiro and Slemrod \(2009\)](#) study the response of consumption to the tax rebates from 2008, which were part of the stimulus package aimed at combatting the Great Recession. They find that only about one-fifth of respondents planned to spend their tax cuts from this stimulus plan. In contrast to the 2001 tax cuts, the 2008 rebate was understood to only be a temporary, one year tax cut. Hence, the low fraction of respondents who planned to spend their rebate checks is broadly in line with the predictions of the theory, which says that a household should save a large chunk of a temporary change in net income.

9.4.4 Uncertainty

We have heretofore assumed that future income is known with certainty. In reality, while households may have a good guess of what future income is, future income is nevertheless uncertain from the perspective of period t – a household could get laid off in period $t + 1$ (income lower than expected) or it could win the lottery (income higher than expected). Our basic results that consumption ought to be forward-looking carry over into an environment with uncertainty – if a household expects an increase in future income, even if that increase is uncertain, the household will want to consume more and save less in the present. In this subsection, we explore the specific role that uncertainty might play for consumption and saving decisions.

Let's consider the simplest possible environment. Suppose that future income can take on two possible values: $Y_{t+1}^h > Y_{t+1}^l$, where the h and l superscripts stand for high and low. Let the probability that income is high be given by $0 \leq p \leq 1$, while the probability of getting low income is $1 - p$. The expected value of Y_{t+1} is the probability-weighted average of possible realizations:

$$E(Y_{t+1}) = pY_{t+1}^h + (1 - p)Y_{t+1}^l \quad (9.56)$$

Here, $E(\cdot)$ is the expectation operator. If $p = 1$ or $p = 0$, then there is no uncertainty and we are back in the standard case with which we have been working. The basic optimization problem of the household is the same as before, with the exception that it will want to maximize *expected* lifetime utility, where utility from future consumption is uncertain because future income is uncertain – if you end up with the low draw of future income, future consumption will be low, and vice-versa. In particular, future consumption will take on two values, given current consumption which is known with certainty:

$$C_{t+1}^h = Y_{t+1}^h + (1 + r_t)(Y_t - C_t) \quad (9.57)$$

$$C_{t+1}^l = Y_{t+1}^l + (1 + r_t)(Y_t - C_t) \quad (9.58)$$

The expected value of future consumption is $E(C_{t+1}) = pC_{t+1}^h + (1 - p)C_{t+1}^l$. The Euler equation characterizing optimal behavior looks similar, but on the right hand side there is *expected* marginal utility of future consumption:

$$u'(C_t) = \beta(1 + r_t)E[u'(C_{t+1})] \quad (9.59)$$

The key insight to understanding the effects of uncertainty is that *the expected value of a function is not in general equal to the function of the expected value*. Marginal utility, $u'(\cdot)$, is itself a function, and as such in general the expected value of the marginal utility of future consumption is not equal to the marginal utility of expected consumption. The example below makes this point clear:

Example

Suppose that the utility function is the natural log, $u(\cdot) = \ln(\cdot)$. Suppose that, given the choice of current C_t , future consumption can take on two values: $C_{t+1}^h = 2$ and $C_{t+1}^l = 1$. Assume that the probability of the high realization is $p = 0.5$. The expected value of consumption is:

$$E(C_{t+1}) = 0.5 \times 2 + 0.5 \times 1 = 1.5 \quad (9.60)$$

Given log utility, the marginal utility of future consumption, $u'(C_{t+1})$, can take on two values as well: $\frac{1}{2}$ and $\frac{1}{1}$. Expected marginal utility is:

$$E[u'(C_{t+1})] = 0.5 \times \frac{1}{2} + 0.5 \times \frac{1}{1} = 0.75 \quad (9.61)$$

Hence, in this particular example, the expected marginal utility of consumption is 0.75. What is the marginal utility of expected consumption? This is just the inverse of expected consumption, which is $\frac{1}{1.5} = \frac{2}{3}$. Note that this is less than the expected marginal utility of consumption.

Let us consider the case in which the *third derivative* of the flow utility function is strictly positive, $u'''(\cdot) > 0$. This is satisfied in the case of log utility used in the example above.

Figure 9.12 plots $u'(C_{t+1})$ as a function of C_{t+1} . The second derivative of the utility function being negative means that this plot is downward-sloping (i.e. the second derivative, $u''(\cdot)$, is the derivative of the first derivative, $u'(\cdot)$, and is hence the slope of $u'(\cdot)$ against C_{t+1}). The third derivative being positive means that the slope gets flatter (i.e. closer to zero, so less negative) the bigger is C_{t+1} . In other words, the plot of marginal utility has a “bowed-in” shape in a way similar to an indifference curve. On the horizontal axis, we draw in the low and high realizations of future consumption. We can evaluate marginal utility at these consumption values by reading off the curve on the vertical axis. Marginal utility will be high when consumption is low and low when consumption is high. The expected value of future consumption, $E[C_{t+1}]$, lies in between the high and low realizations of consumption. The marginal utility of expected consumption, $u'(E[C_{t+1}])$, can be determined by reading off the curve at this point on the vertical axis. The expected marginal utility of consumption can be determined by drawing a straight line between marginal utility evaluated in the low draw of consumption and marginal utility when consumption is high. We then determine expected marginal utility of consumption by reading off of the line (not the curve) at the expected value of future consumption. Given the bowed-in shape of the plot of marginal utility, the line lies everywhere above the curve (i.e. marginal utility is convex, given a positive third derivative). This means that $E[u'(C_{t+1})] > u'(E[C_{t+1}])$ – i.e. expected marginal utility is higher than the marginal utility of expected consumption. This is shown in the figure below and a formal proof follows.

Figure 9.12: Expected Marginal Utility and Marginal Utility of Expected Consumption

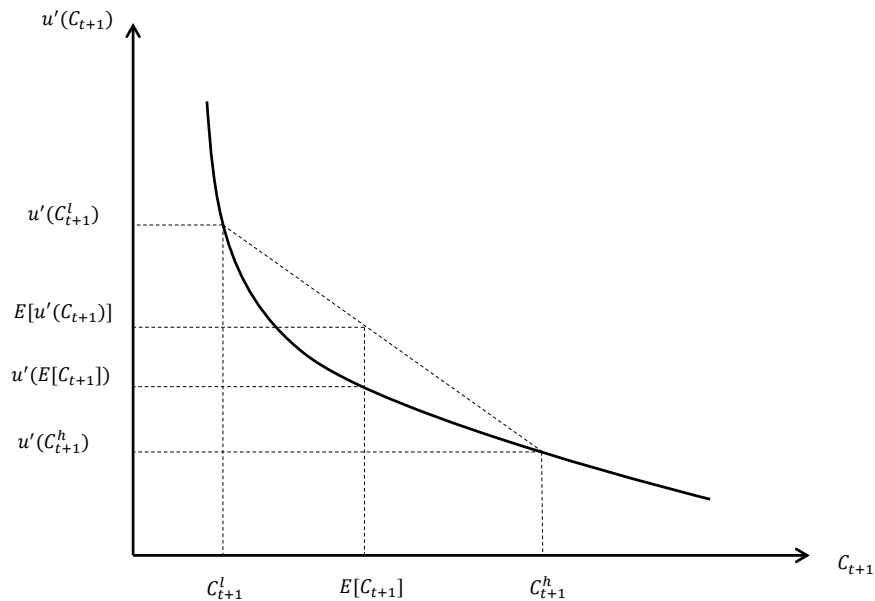

Mathematical Diversion

We want to prove that expected marginal utility of future consumption can be evaluated at the line connecting the marginal utilities of consumption in the low and high states. The slope of the line connecting these points is simply “rise over run,” or:

$$\text{slope} = \frac{u'(C_{t+1}^h) - u'(C_{t+1}^l)}{C_{t+1}^h - C_{t+1}^l} \quad (9.62)$$

Since we are dealing with a line, the slope at any point must be the same. Hence, the slope at the point $E[C_{t+1}]$ must be equal to the expression found above. Let’s treat the value of marginal utility of consumption evaluated at $E[C_{t+1}]$ as an unknown, call it x . The slope of the line at this point is equal to:

$$\text{slope} = \frac{x - u'(C_{t+1}^l)}{E[C_{t+1}] - C_{t+1}^l} \quad (9.63)$$

Because the slope is everywhere the same, we have:

$$\frac{x - u'(C_{t+1}^l)}{E[C_{t+1}] - C_{t+1}^l} = \frac{u'(C_{t+1}^h) - u'(C_{t+1}^l)}{C_{t+1}^h - C_{t+1}^l} \quad (9.64)$$

Note that $E[C_{t+1}] = pC_{t+1}^h + (1-p)C_{t+1}^l$, which can be written: $E[C_{t+1}] = p(C_{t+1}^h - C_{t+1}^l) + C_{t+1}^l$. Hence, we can write (9.64) as:

$$\frac{x - u'(C_{t+1}^l)}{p(C_{t+1}^h - C_{t+1}^l)} = \frac{u'(C_{t+1}^h) - u'(C_{t+1}^l)}{C_{t+1}^h - C_{t+1}^l} \quad (9.65)$$

Let’s work through this expression to solve for x . First:

$$x - u'(C_{t+1}^l) = p(C_{t+1}^h - C_{t+1}^l) \frac{u'(C_{t+1}^h) - u'(C_{t+1}^l)}{C_{t+1}^h - C_{t+1}^l} \quad (9.66)$$

This simplifies to:

$$x - u'(C_{t+1}^l) = pu'(C_{t+1}^h) - pu'(C_{t+1}^l) \quad (9.67)$$

Which further simplifies to:

$$x = pu'(C_{t+1}^h) + (1-p)u'(C_{t+1}^l) = E[u'(C_{t+1})] \quad (9.68)$$

In other words, the line evaluated at $E[C_{t+1}]$ is the expected marginal utility of consumption.

Having now shown how we can graphically determine the expected marginal utility of consumption, let us graphically analyze what happens to the expected marginal utility of consumption when there is an increase in uncertainty. To be precise, let us consider what is called a mean-preserving spread. In particular, suppose that the high realization of income gets bigger, $Y_{1,t+1}^h > Y_{0,t+1}^h$, and the low realization of income gets smaller, $Y_{1,t+1}^l < Y_{0,t+1}^l$, in such a way that there is no change in the expected realization of income (holding the probabilities fixed). In particular:

$$pY_{1,t+1}^h + (1-p)Y_{1,t+1}^l = pY_{0,t+1}^h + (1-p)Y_{0,t+1}^l \quad (9.69)$$

The higher and lower possible realizations of income in the next period translate into higher and lower possible realizations of future consumption without affecting the expected value of future consumption. We can graphically characterize how this increase in uncertainty impacts the expected marginal utility of consumption. This is shown below in Figure 9.13. We can see that the increase in uncertainty raises the expected marginal utility of consumption, even though expected consumption, and hence also the marginal utility of expected consumption, are both unaffected.

Figure 9.13: An Increase in Uncertainty

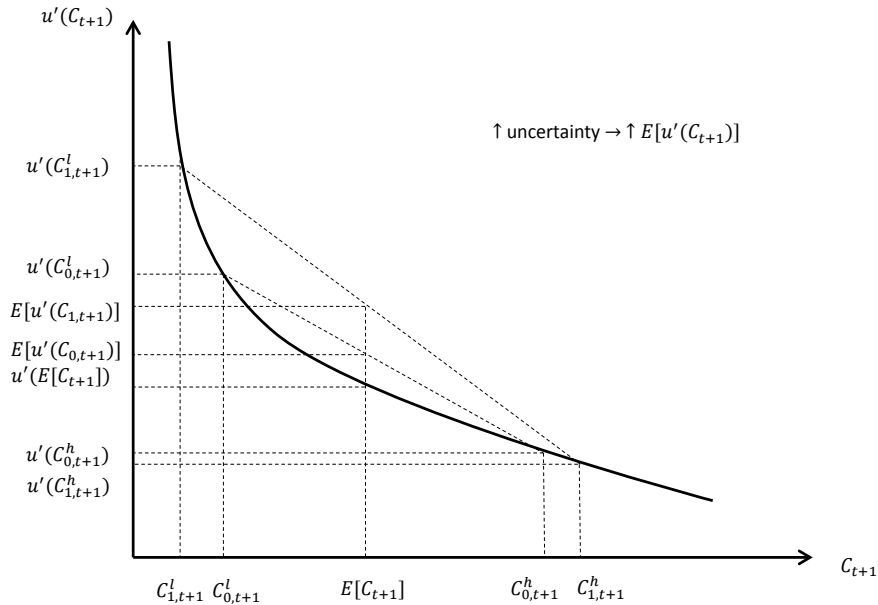

An intuitive way to think about this graph is as follows. If the third derivative of the utility function is positive, so that marginal utility is convex in consumption, the heightened

bad state raises marginal utility of consumption more than the improved good state lowers marginal utility, so on net expected marginal utility increases. This means that a mean-preserving increase in uncertainty will raise the expected marginal utility of consumption. How will this impact optimal consumer behavior? To be optimizing, a household must choose a consumption allocation such that (9.59) holds. If the increase in uncertainty drives up the expected marginal utility of consumption, the household must alter its behavior in such a way to as make the Euler equation hold. The household can do this by reducing C_t , which drives up $u'(C_t)$ and drives down $E[u'(C_{t+1})]$ (because reducing C_t raises expected future consumption via (9.57)). In other words, a household ought to react to an increase in uncertainty by increasing its saving. We call this *precautionary saving*.

The motive for saving in the work of most of this chapter is that saving allows a household to smooth its consumption relative to its income. Our discussion in this subsection highlights an additional motivation for saving behavior. In this uncertainty example, saving is essentially a form of self-insurance. When you purchase conventional insurance products, you are giving up some current consumption (i.e. paying a premium) so that, in the event that something bad happens to you in the future, you get a payout that keeps your consumption from falling too much. That's kind of what is going on in the precautionary saving example, although differently from an explicit insurance product the payout is not contingent on the realization of a bad state. You give up some consumption in the present (i.e. you save), which gives you more of a cushion in the future should you receive a low draw of income.

Empirical Evidence

9.4.5 Consumption and Predictable Changes in Income

Let us continue with the idea that the realization of future income is uncertain. While there is a degree of uncertainty in the realization of future income, some changes in income are predictable (e.g. you sign a contract to start a new job with a higher salary starting next year). Our analysis above shows that current consumption ought to react to anticipated changes in future income – i.e. $\frac{\partial C(\cdot)}{\partial E[Y_{t+1}]} > 0$.

Suppose, for simplicity, that $\beta(1 + r_t) = 1$. This means that the Euler equation under uncertainty reduces to:

$$u'(C_t) = E[u'(C_{t+1})] \tag{9.70}$$

In other words, an optimizing household will choose a consumption bundle so as to equate the marginal utility of consumption today with the expected marginal utility of consumption in the future. If there were no uncertainty, (9.70) would implies that $C_t = C_{t+1}$ – i.e. the

household would desire equal consumption across time. This will not in general be true if we assume that the future is uncertain via the arguments above that the marginal utility of expected future consumption does not in general equal the expected value of the marginal utility of future consumption. If we are willing to assume, however and in contrast to what we did above in discussing precautionary saving, that the third derivative of the utility function is zero, as would be the case with the quadratic utility function given above in (9.10), it would be the case that $C_t = E[C_{t+1}]$ even if there is uncertainty over the future. In other words, the household would expect consumption to be constant across time, even though it may not be after the fact given that the realization of future income is uncertain.

Hall (1978) assumes a utility function satisfying these properties and derives the implication that $C_t = E[C_{t+1}]$. He refers to this property of consumption as the “random walk.” It implies that expected future consumption equals current consumption, and that changes in consumption ought to be unpredictable. Hall (1978) and others refer to the theory underlying this implication as the “life cycle - permanent income hypothesis.” The permanent income hypothesis is often abbreviated as PIH. While this only strictly holds if (i) $\beta(1 + r_t) = 1$ and (ii) the third derivative of the utility function is zero, so that there is no precautionary saving, something close to the random walk implication that changes in consumption ought to be unpredictable holds more generally in an approximate sense.

There have been many empirical tests of the PIH. Suppose that a household becomes aware at time t that its income will go up in the future. From our earlier analysis, this ought to result in an increase in C_t and a reduction in S_t . If the random walk implication holds, then in expectation C_{t+1} should go up by the same amount as the increase in C_t . This has a stark implication: consumption ought not to change (relative to its period t value) in period $t + 1$ when income changes. This is because $E[C_{t+1}] - C_t = 0$ if the assumptions underlying the random walk model hold. In other words, consumption ought not to react in the period that income changes, because this anticipated change in income has already been worked into the consumption plan of an optimizing household. Below we describe two empirical studies of this prediction of the model.

Empirical Evidence

Social Security taxes are about seven percent of your gross income, and your employer withholds these payroll taxes from your paycheck and remits them directly to the government. However, there is a cap on the amount of income that is subject to Social Security taxes. In 2016, the maximum amount of taxable income subject to the Social Security tax was \$118,500. Suppose that a household earns double this amount per year, or \$237,000. Suppose this worker is paid

monthly. For each of the first six months of the year, about 7 percent of your monthly income is withheld. But starting in July, there is no 7 percent withheld, because you have exceeded the annual cap. Hence, a worker with this level of income will experience an increase in his/her take-home pay starting in the second half of the year. Since this increase in take-home pay is perfectly predictable from the beginning of the year, the household's consumption behavior should not change when its after-tax paycheck goes up in the second half of the year. In other words, consumption in the first half of the year ought to incorporate the knowledge that take-home pay will increase in the second half of the year, and there should be no change in consumption in the second half of the year relative to the first half of the year.

[Parker \(1999\)](#) studies the reaction of consumption of households who have withholding of Social Security phased out at some point in the calendar year. He finds that consumption increases when take-home pay predictably increases after the Social Security tax withholding phases out. This is inconsistent with the predictions of the theory.

As another example of an empirical test of the PIH, there is a well-known monthly mortality cycle. In particular, deaths tend to decline immediately before the first day of a new month but spike immediately thereafter. [Evans and Moore \(2012\)](#) provide a novel explanation for this mortality cycle. They argue, and provide evidence, that the mortality cycle is tied to physical activity, which is in turn tied to receipt of income. In particular, greater physical activity is correlated with higher (short run) mortality rates – e.g. you can't get in a car accident if you aren't driving, you can't die of an overdose if you are not taking drugs, etc.. They document that physical activity is correlated with receipt of paychecks. Many workers are paid on or around the first of the month. They argue that the receipt of a paycheck (which is predictable), leads to a consumption boom, which triggers higher mortality. That consumption would react to a predictable change in income (such as receipt of paycheck) is inconsistent with the predictions of the theory.

9.4.6 Borrowing Constraints

In our baseline analysis, we have assumed that a household can freely borrow or save at interest rate r_t . In reality, many households face imperfect (or no) access to credit markets. Households may not be able to borrow at all, or the interest rate on borrowing may exceed the

interest that can be earned on saving. We refer to such situations as borrowing constraints.

Consider first an extreme form of a borrowing constraint. In particular, it is required that $S_t \geq 0$. In other words, a household cannot borrow in period t , although it can freely save at r_t . This is depicted graphically below in Figure 9.14. The strict borrowing constraint introduces a vertical kink into the budget line at the endowment point. Points where $C_t > Y_t$ are no longer feasible. The hypothetical budget line absent the borrowing constraint is depicted in the dashed line.

Figure 9.14: Borrowing Constraint: $S_t \geq 0$

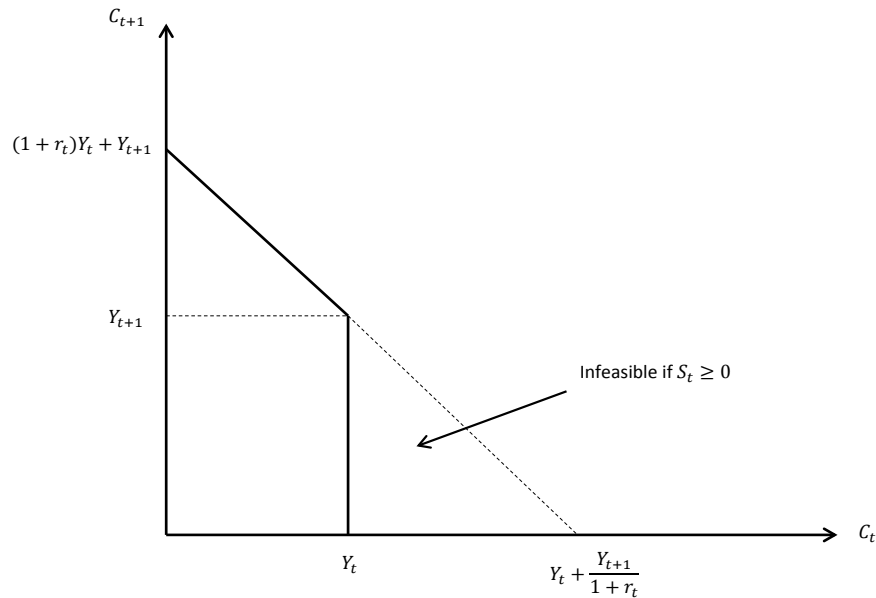

A less extreme version of a borrowing constraint is a situation in which the interest rate on borrowing exceeds the interest rate on saving, i.e. $r_t^b > r_t^s$, where r_t^b is the borrowing rate and r_t^s the saving rate. This introduces a kink in the budget constraint at the endowment point, but it is not a completely vertical kink – the budget line is simply steeper in the borrowing region in comparison to the saving region. The strict constraint with $S_t \geq 0$ is a special case of this, where $r_t^b = \infty$.

Figure 9.15: Borrowing Constraint: $r_t^b > r_t^s$

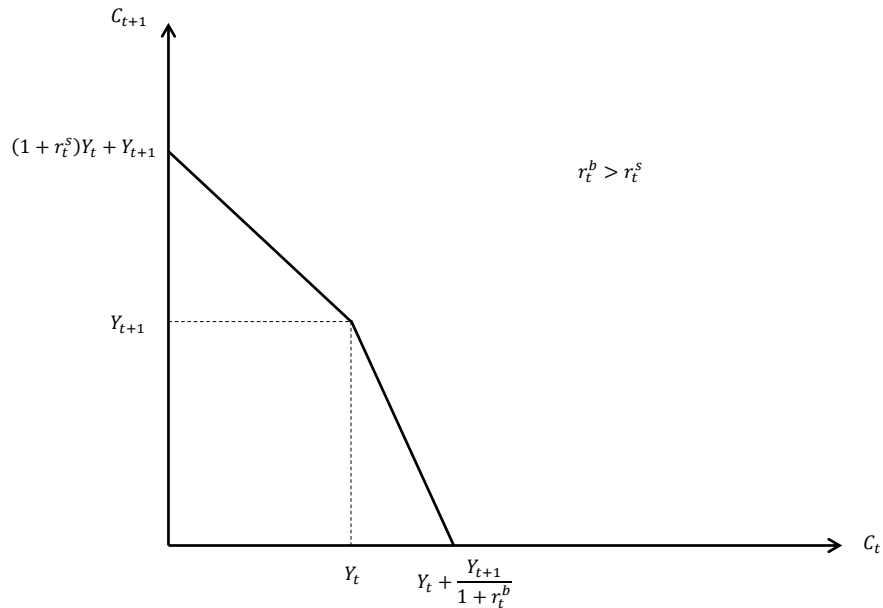

For the remainder of this subsection, let's continue with the strict borrowing constraint in which $S_t \geq 0$. Figure 9.16 shows a case where the borrowing constraint is *binding*: by this we mean a situation in which the household would like to choose a consumption bundle where it borrows in the first period (shown with the dashed indifference curve, and labeled $C_{0,d,t}, C_{0,d,t+1}$). Since this point is unattainable, the household will locate on the closest possible indifference curve, which is shown with the solid line. This point will occur at the kink in the budget constraint – in other words, if the household would like to borrow in the absence of the borrowing constraint, the best it can do is to consume its endowment each period, with $C_{0,t} = Y_{0,t}$ and $C_{0,t+1} = Y_{0,t+1}$. Note, because the budget line is kinked at this point, the Euler equation will *not* hold – the slope of the indifference curve is not tangent to the budget line at this point. The borrowing constraint would not bind if the household would prefer to save – if it prefers to save, the fact that it cannot borrow is irrelevant. We would say this is a non-binding borrowing constraint.

Figure 9.16: A Binding Borrowing Constraint

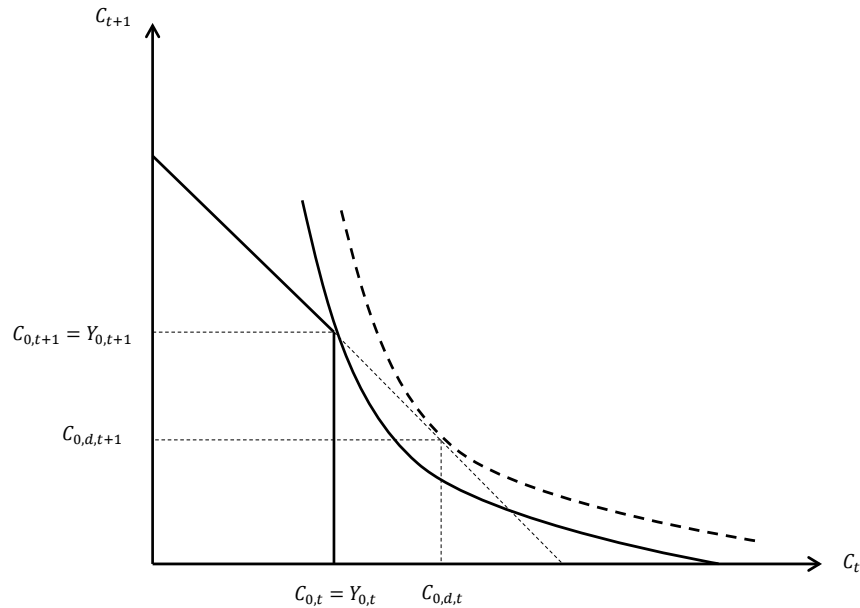

Let's examine what happens to consumption in response to changes in current and future income when a household faces a binding borrowing constraint. Suppose that there is an increase in current income, from $Y_{0,t}$ to $Y_{1,t}$. This shifts the endowment point (and hence the kink in the budget line) out to the right, as shown in Figure 9.17. In the absence of the borrowing constraint, the household would move from $C_{0,d,t}, C_{0,d,t+1}$ to $C_{1,d,t}, C_{1,d,t+1}$, shown with the blue dashed indifference curve. As long as the increase in current income is not so big that the borrowing constraint ceases to bind, this point remains unattainable to the household. The best the household will be able to do is to locate at the new kink, which occurs along the dashed orange indifference curve. Current consumption increases by the full amount of the increase in current income and there is no change in future consumption. Intuitively, if the household would like to consume more than its current income in the absence of the constraint, giving it some more income it just going to induce it to spend all of the additional income.

Figure 9.17: A Binding Borrowing Constraint, Increase in Y_t

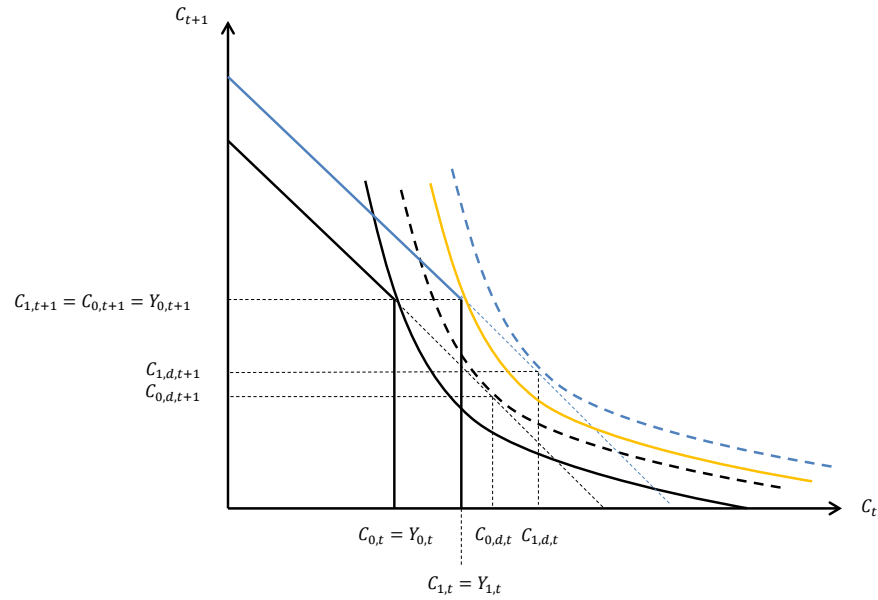

Next, consider a case in which the household anticipates an increase in future income, from $Y_{0,t+1}$ to $Y_{1,t+1}$. This causes the endowment point to shift up. Absent the borrowing constraint, the household would like to increase both current and future consumption to $C_{1,d,t}$ and $C_{1,d,t+1}$. This point is unattainable. The best the household can do is to locate at the new kink point, which puts it on the orange indifference curve. In this new bundle, current consumption is unchanged, and future consumption increases by the amount of the (anticipated) change in future income.

Figure 9.18: A Binding Borrowing Constraint, Increase in Y_{t+1}

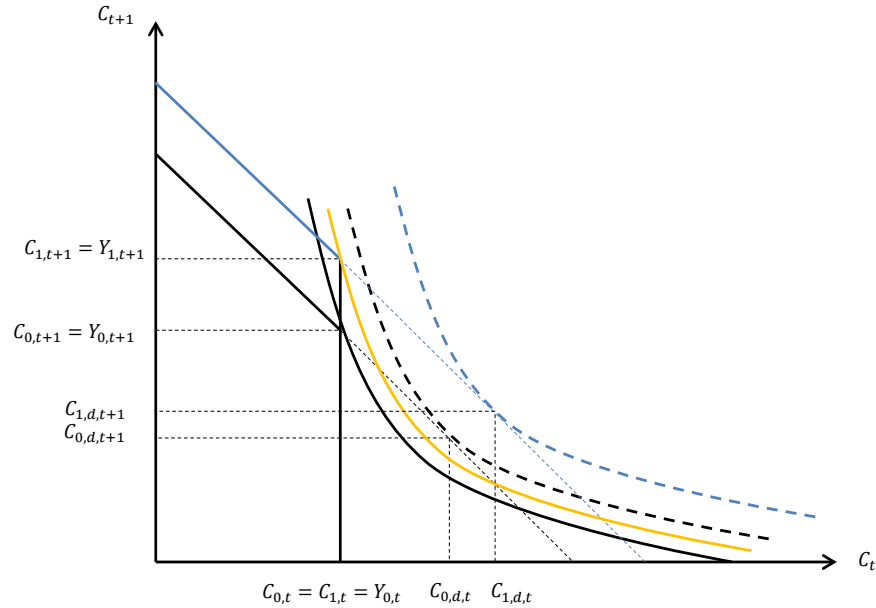

A binding borrowing constraint will significantly alter the implications of the basic two period consumption model. In particular, the MPC out of current income will be one, as opposed to less than one, and consumption will not be forward looking. There is an important implication of this result for policy. Above we argued that transitory tax cuts would have smaller effects than permanent tax cuts if the household is trying to smooth its consumption relative to its income. This will not be the case if the household is facing a binding borrowing constraint – the effect on consumption will be independent of the perceived persistence of the tax cut. For political reasons, very persistent tax cuts are often unpopular because of effects these might have on the national debt. If some fraction of the population is borrowing constrained, our analysis suggests that “targeted and temporary” tax cuts may nevertheless have a big stimulative effect on consumption even if they are temporary, so long as the tax cuts are targeted at those likely to be borrowing constrained (typically members of the population with little wealth and low income). Another implication of binding borrowing constraints is that it might help provide resolution to some of the documented empirical failures of the random walk model. Absent a borrowing constraint, consumption ought to be forward-looking, and anticipated future changes in income ought to already be incorporated into current consumption. But with a binding borrowing constraint, consumption ceases to be forward-looking, and consumption cannot react to an anticipated change in income until that change in income is realized.

9.5 Summary

- The consumption-savings problem is dynamic. Given its lifetime resources, the household chooses consumption and saving to maximize lifetime utility.
- The household faces a sequence of period budget constraints which can be combined into a lifetime budget constraint which says the present discounted value of consumption equals the present discounted value of income.
- The opportunity cost of one unit of current consumption is $1 + r_t$ future units of consumption. r_t must be greater than -1 because a consumer would never exchange one unit of consumption today for fewer than zero units of future consumption; r_t could be negative if income is otherwise non-storable.
- The key optimality condition coming out of the household's optimization problem is the Euler equation. The Euler equation equates the marginal rate of substitution of consumption today for consumption tomorrow equal to one plus the real interest rate.
- Graphically, the optimal consumption bundle is where the indifference curve just "kisses" the budget constraint.
- Current consumption increases with current income, but less than one for one. The reason is that diminishing marginal returns of consumption leads the household to smooth consumption.
- Similarly, current consumption increases with increases in future income. This implies that favorable news about future income should be reflected in today's consumption.
- An increase in the real interest rate makes current consumption more expensive which is known as the substitution effect. The increase in the real interest rate also has either a positive or negative income effect depending on if the consumer is a borrower or saver. When the income effect is negative, current consumption unambiguously falls in response to an increase in the real interest rate. When the income and substitution effects move in different directions, the response of consumption in period t to an increase in the real interest rate is theoretically ambiguous.
- Permanent changes in income ought to have larger effects on current consumption than temporary changes. A corollary of this is that a permanent tax cut will stimulate consumption more than a temporary tax cut.

- Fluctuations in asset prices and wealth can impact consumption in ways similar to changes in current or future income.
- If the future is uncertain, there may be an additional motivation saving other than smoothing consumption relative to income. This is known as precautionary saving and emerges if the third derivative of the utility function is positive. If that is the case, the expected value of the marginal utility of future consumption exceeds the marginal utility of the expected value of future consumption.
- If a household takes all information about current and future income into its current consumption choice, changes in future consumption should be unpredictable provided $\beta(1 + r_t) = 1$ and the third derivative of the utility function is zero. This is known as the random walk hypothesis.
- Binding borrowing constraints make consumption less forward-looking and less smooth relative to income.

Key Terms

- Marginal utility of consumption
- Diminishing marginal utility
- Euler equation
- Consumption function
- Substitution effect
- Income effect
- Marginal propensity to consume
- Permanent income hypothesis
- Borrowing constraints

Questions for Review

1. Explain why $S_{t+1} = 0$.
2. Starting with 9.4 and 9.5, mathematically derive the lifetime budget constraint.
3. Suppose you win a lottery and you are given the option between \$10 today and \$0 tomorrow or \$5 today and \$5 tomorrow. Which would you choose?

4. Write down the Euler equation in general terms and describe its economic intuition.
5. Graphically depict the solution to the consumption-saving problem. Clearly state why you know it is the solution.
6. Graphically show the effects of an increase in Y_t . Does consumption unambiguously go up in both periods? Why or why not?
7. Graphically show the effects of an increase in r_t . Does consumption unambiguously go up in both periods? Why or why not?
8. Suppose $\beta(1 + r_t) < 1$. Is the growth rate of consumption positive, negative, or zero?

Exercises

1. **Consumption-Savings** Consider a consumer with a lifetime utility function

$$U = u(C_t) + \beta u(C_{t+1})$$

that satisfies all the standard assumptions listed in the book. The period t and $t + 1$ budget constraints are

$$C_t + S_t = Y_t$$

$$C_{t+1} + S_{t+1} = Y_{t+1} + (1 + r)S_t$$

- (a) What is the optimal value of S_{t+1} ? Impose this optimal value and derive the lifetime budget constraint.
- (b) Derive the Euler equation. Explain the economic intuition of the equation.
- (c) Graphically depict the optimality condition. Carefully label the intercepts of the budget constraint. What is the slope of the indifference curve at the optimal consumption basket, (C_t^*, C_{t+1}^*) ?
- (d) Graphically depict the effects of an increase in Y_{t+1} . Carefully label the intercepts of the budget constraint. Is the slope of the indifference curve at the optimal consumption basket, (C_t^*, C_{t+1}^*) , different than in part c?
- (e) Now suppose C_t is taxed at rate τ so consumers pay $1 + \tau$ for one unit of period t consumption. Redo parts a-c under these new assumptions.

- (f) Suppose the tax rate increases from τ to τ' . Graphically depict this. Carefully label the intercepts of the budget constraint. Is the slope of the indifference curve at the optimal consumption basket, (C_t^*, C_{t+1}^*) , different than in part e? Intuitively describe the roles played by the substitution and income effects. Using this intuition, can you definitively prove the sign of $\frac{\partial C_t^*}{\partial \tau}$ and $\frac{\partial C_{t+1}^*}{\partial \tau}$? It is not necessary to use math for this. Describing it in words is fine.

2. **Consumption with Borrowing Constraints** Consider the following consumption-savings problem. The consumer maximizes

$$\max_{C_t, C_{t+1}, S_t} \ln C_t + \beta \ln C_{t+1}$$

subject to the lifetime budget constraint

$$C_t + \frac{C_{t+1}}{1+r_t} = Y_t + \frac{Y_{t+1}}{1+r_t}$$

and the borrowing constraint

$$C_t \leq Y_t.$$

This last constraint says that savings cannot be negative in the first period. Equivalently, this is saying consumers cannot borrow in the first period.

- Draw the budget constraint.
 - Assuming the constraint does not bind, what is the Euler equation?
 - Using the Euler equation, lifetime budget constraint and borrowing constraint, solve for the period t consumption function. Clearly state under what circumstances the borrowing constraint binds.
 - Suppose $Y_t = 3$, $Y_{t+1} = 10$, $\beta = 0.95$ and $r = 0.1$. Show the borrowing constraint binds.
 - Suppose there is a one time tax rebate that increases Y_t to 4. Leave $Y_{t+1} = 10$, $\beta = 0.95$ and $r = 0.1$. What is the marginal propensity to consume out of this tax rebate?
3. **[Excel Problem]** Suppose we have a household with the following lifetime utility function:

$$U = \ln C_t + \beta \ln C_{t+1}$$

- Create an Excel file to compute indifference curves numerically. Suppose

that $\beta = 0.95$. Create range of values of C_{t+1} from 0.5 to 1.5, with a space of 0.01 between (i.e. create a column of potential C_{t+1} values ranging from 0.5, 0.51, 0.52, and so on). For each value of C_{t+1} , solve for the value of C_t which would yield a lifetime utility level of $U = 0$. Plot this.

- (b) Re-do part (a), but for values of lifetime utility of $U = -0.5$ and $U = 0.5$.
- (c) Verify that “northeast” is the direction of increasing preference and that the indifference curves associated with different levels of utility do not cross.

4. Suppose we have a household with the following (non-differentiable) utility function:

$$U = \min(C_t, C_{t+1})$$

With this utility function, utility equals the minimum of period t and $t + 1$ consumption. For example, if $C_t = 3$ and $C_{t+1} = 4$, then $U = 3$. If $C_t = 3$ and $C_{t+1} = 6$, then $U = 3$. If $C_t = 5$ and $C_{t+1} = 4$, then $U = 4$.

- (a) Since this utility function is non-differentiable, you cannot use calculus to characterize optimal behavior. Instead, think about it a little bit without doing any math. What must be true about C_t and C_{t+1} if a household with this utility function is behaving optimally?
 - (b) The period t and $t + 1$ budget constraints are 9.4 and 9.5 respectively. Use the condition from (a) and the intertemporal budget constraint to derive the consumption function.
 - (c) Is the MPC between 0 and 1? Is consumption decreasing in the real interest rate?
5. **Some Numbers.** A consumer’s income in the current period is $Y_t = 250$ and income in the future period is $Y_{t+1} = 300$. The real interest rate r_t is 0.05, or 5%, per period. Assume there are no taxes.
- (a) Determine the consumer’s lifetime wealth (present discounted value of lifetime income).
 - (b) As in the previous problem, assume that the consumer’s preferences are such that the current and future consumption are perfect complements, so that he or she always wants to have equal consumption in the current and future periods. Draw the consumer’s indifference curves.
 - (c) Solve for the consumer’s optimal current-period and future-period con-

sumption, and for optimal saving as well. Is the consumer a lender or a borrower? Show this situation in a diagram with the consumer's budget constraint and indifference curves.

- (d) Now suppose that instead of $Y_t = 250$, the consumer has $Y_t = 320$. Again, determine optimal consumption in the current and future periods and optimal saving, and show this in a diagram. Is the consumer a lender or a borrower?
- (e) Explain the differences in your results between parts 5c and 5d.

Chapter 10

A Multi-Period Consumption-Saving Model

In this chapter we consider an extension of the two period consumption model from Chapter 9 to more than two periods. The basic intuition from the two period model carries over to the multi-period setting. The addition of more than two periods makes the distinction between permanent and transitory changes in income more stark. It also allows us to think about consumption-saving behavior over the life cycle.

10.1 Multi-Period Generalization

Suppose that the household lives for the current period, period t , and T subsequent periods, to period $t+T$. This means that the household lives for a total of $T+1$ periods – the current period plus T additional periods. For simplicity, assume that there is no uncertainty. The household begins its life with no wealth. Each period there is a potentially different interest rate, r_{t+j} , for $j = 0, \dots, T-1$, which determines the rate of return on saving taken from period $t+j$ to $t+j+1$.

The household faces a sequence of flow budget constraints (one in each period) as follows:

$$C_t + S_t \leq Y_t \quad (10.1)$$

$$C_{t+1} + S_{t+1} \leq Y_{t+1} + (1 + r_t)S_t \quad (10.2)$$

$$C_{t+2} + S_{t+2} \leq Y_{t+2} + (1 + r_{t+1})S_{t+1} \quad (10.3)$$

⋮

$$C_{t+T} + S_{t+T} \leq Y_{t+T} + (1 + r_{t+T-1})S_{t+T-1} \quad (10.4)$$

In the multi-period framework the distinction between the stock of savings and flow saving is starker than in the two period model. In the flow budget constraints, S_{t+j} , for $j = 0, \dots, T$, denotes the stock of savings (with an s at the end) that the household takes from period $t+j$ into period $t+j+1$. Flow saving in each period is the change in the stock of savings, or $S_{t+j} - S_{t+j-1}$ is flow saving in period $t+j$. Only when $j = 0$ (i.e. the first period) will flow saving and the stock of savings the household takes into the next period be the same.

As in the two period model, S_{t+T} denotes the stock of savings which the household takes from period $t+T$ into $t+T+1$. Since the household isn't around for period $t+T+1$, and since no lender will allow the household to die in debt, it must be the case that $S_{t+T} = 0$. This is a terminal condition, similar to the idea that $S_{t+1} = 0$ in the two period framework. So as to simplify matters, let us assume that $r_{t+j} = r$ for all $j = 0, \dots, T-1$. In other words, let us assume that the interest rate is constant across time. This simplifies the analysis when collapsing the sequence of flow budget constraints into one intertemporal budget constraint, but does not fundamentally affect the analysis.

Making use of our terminal condition, $S_{t+T} = 0$, plus the assumption that each period's budget constraint holds with equality, we can iteratively eliminate the savings terms from the flow budget constraints starting from the end of the household's life. This is conceptually similar to what we did in the two period model. For example, one can solve for $S_{t+T-1} = \frac{C_{t+T}}{1+r} - \frac{Y_{t+T}}{1+r}$ in the final period. Then one can plug this in to the $t+T-1$ budget constraint, and then solve for S_{t+T-2} . One can keep going. Doing so, one arrives at a generalized intertemporal budget constraint given by (10.5):

$$C_t + \frac{C_{t+1}}{1+r} + \frac{C_{t+2}}{(1+r)^2} + \dots + \frac{C_{t+T}}{(1+r)^T} = Y_t + \frac{Y_{t+1}}{1+r} + \frac{Y_{t+2}}{(1+r)^2} + \dots + \frac{Y_{t+T}}{(1+r)^T} \quad (10.5)$$

In words, this says that the present discounted value of the stream of consumption must equal the present discounted value of the stream of income. To discount a future value back to period t , you multiply by $\frac{1}{(1+r)^j}$ for a value j periods from now. This denotes how much current value you'd need to have an equivalent future value, given a fixed interest rate of r . Expression (10.5) is a straightforward generalization of the intertemporal budget constraint in the two period setup.

Household preferences are an extension of the two period case. In particular, lifetime utility is:

$$U = u(C_t) + \beta u(C_{t+1}) + \beta^2 u(C_{t+2}) + \beta^3 u(C_{t+3}) + \dots + \beta^T u(C_{t+T}) \quad (10.6)$$

This setup embeds what is called geometric discounting. In any given period, you discount the next period's utility flow by a fixed factor, $0 < \beta < 1$. Put differently, relative to period t , you value period $t+1$ utility at β . Relative to period $t+2$, you also value period $t+3$ utility at β . This means that, relative to period t , you value period $t+2$ utility at β^2 . And so on. Effectively, your discount factor between utility flows depends only on the number of periods away a future utility flow is. Since $\beta < 1$, if T is sufficiently big, then the relative weight on utility in the final period relative to the first period can be quite low.

The household problem can be cast as choosing a sequence of consumption, $C_t, C_{t+1}, C_{t+2}, \dots, C_{t+T}$ to maximize lifetime utility subject to the intertemporal budget constraint:

$$\max_{C_t, C_{t+1}, \dots, C_{t+T}} U = u(C_t) + \beta u(C_{t+1}) + \beta^2 u(C_{t+2}) + \beta^3 u(C_{t+3}) + \dots + \beta^T u(C_{t+T}) \quad (10.7)$$

s.t.

$$C_t + \frac{C_{t+1}}{1+r} + \frac{C_{t+2}}{(1+r)^2} + \dots + \frac{C_{t+T}}{(1+r)^T} = Y_t + \frac{Y_{t+1}}{1+r} + \frac{Y_{t+2}}{(1+r)^2} + \dots + \frac{Y_{t+T}}{(1+r)^T} \quad (10.8)$$

One can find the first order optimality conditions for this problem in an analogous way to the two period case – one solves for one of the consumption values from the intertemporal budget constraint in terms of the other consumption levels (e.g. solve for C_{t+T} in the intertemporal budget constraint), plugs this into the objective function, and this turns the problem into an unconstrained problem of choosing the other consumption values. Because this is somewhat laborious, we will not work through the optimization, although we do so in the example below for log utility with three total periods. The optimality conditions are a sequence of T Euler equations for each two adjacent periods of time. These can be written:

$$u'(C_t) = \beta(1+r)u'(C_{t+1}) \quad (10.9)$$

$$u'(C_{t+1}) = \beta(1+r)u'(C_{t+2}) \quad (10.10)$$

$$u'(C_{t+2}) = \beta(1+r)u'(C_{t+3}) \quad (10.11)$$

⋮

$$u'(C_{t+T-1}) = \beta(1+r)u'(C_{t+T}) \quad (10.12)$$

$$(10.13)$$

These Euler equations look *exactly* like the Euler equation for the two period problem. Since there are $T + 1$ total periods, there are T sets of adjacent periods, and hence T Euler equations. Note that one can write the Euler equations in different ways. For example, one could plug (10.10) into (10.9) to get: $u'(C_t) = \beta^2(1+r)^2u'(C_{t+2})$.

The intuition for why these Euler equations must hold at an optimum is exactly the same as in a two period model. Consider increasing C_{t+1} by a small amount. The marginal benefit of this is the marginal utility of period $t + 1$ consumption, which is $\beta u'(C_{t+1})$ (it is multiplied by β to discount this utility flow back to period t). The marginal cost of doing this is saving one fewer unit in period t , which means reducing consumption in the next period by $1 + r$ units. The marginal cost is thus $\beta^2(1+r)u'(C_{t+2})$. Equating marginal benefit to marginal

cost gives (10.10). One can think about there being a separate indifference curve / budget line diagram for each two adjacent periods of time.

The example below works all this out for a three period case (so $T = 2$) with log utility.

Example

Suppose that a household lives for a total of three periods, so $T = 2$ (two future periods plus the present period). Suppose that the flow utility function is the natural log, so that lifetime utility is:

$$U = \ln C_t + \beta \ln C_{t+1} + \beta^2 \ln C_{t+2} \quad (10.14)$$

Assume that the interest rate is constant across time at r . The sequence of flow budget constraints, assumed to hold with equality and imposing the terminal condition, are:

$$C_t + S_t = Y_t \quad (10.15)$$

$$C_{t+1} + S_{t+1} = Y_{t+1} + (1+r)S_t \quad (10.16)$$

$$C_{t+2} = Y_{t+2} + (1+r)S_{t+1} \quad (10.17)$$

In (10.17), solve for S_{t+1} :

$$S_{t+1} = \frac{C_{t+2}}{1+r} - \frac{Y_{t+2}}{1+r} \quad (10.18)$$

Now, plug (10.18) into (10.16):

$$C_{t+1} + \frac{C_{t+2}}{1+r} = Y_{t+1} + \frac{Y_{t+2}}{1+r} + (1+r)S_t \quad (10.19)$$

Now, solve for S_t in (10.19):

$$S_t = \frac{C_{t+1}}{1+r} + \frac{C_{t+2}}{(1+r)^2} - \frac{Y_{t+1}}{1+r} - \frac{Y_{t+2}}{(1+r)^2} \quad (10.20)$$

Now, plug (10.20) into the period t flow budget constraint for S_t . Re-arranging terms yields:

$$C_t + \frac{C_{t+1}}{1+r} + \frac{C_{t+2}}{(1+r)^2} = Y_t + \frac{Y_{t+1}}{1+r} + \frac{Y_{t+2}}{(1+r)^2} \quad (10.21)$$

This is the intertemporal budget constraint when $T = 2$, a special case of the more general case presented above, (10.5).

The household's problem is then:

$$\max_{C_t, C_{t+1}, C_{t+2}} U = \ln C_t + \beta \ln C_{t+1} + \beta^2 \ln C_{t+2} \quad (10.22)$$

s.t.

$$C_t + \frac{C_{t+1}}{1+r} + \frac{C_{t+2}}{(1+r)^2} = Y_t + \frac{Y_{t+1}}{1+r} + \frac{Y_{t+2}}{(1+r)^2} \quad (10.23)$$

To solve this constraint problem, solve the intertemporal budget constraint for one of the choice variables. In particular, let's solve for C_{t+2} :

$$C_{t+2} = (1+r)^2 Y_t + (1+r) Y_{t+1} + Y_{t+2} - (1+r)^2 C_t - (1+r) C_{t+1} \quad (10.24)$$

Now, we can plug this into (10.22), which transforms the problem into an unconstrained one of choosing C_t and C_{t+1} :

$$\begin{aligned} \max_{C_t, C_{t+1}} U = & \ln C_t + \beta \ln C_{t+1} + \dots \\ & + \beta^2 \ln \left[(1+r)^2 Y_t + (1+r) Y_{t+1} + Y_{t+2} - (1+r)^2 C_t - (1+r) C_{t+1} \right] \end{aligned}$$

The partial derivatives with respect to C_t and C_{t+1} are:

$$\frac{\partial U}{\partial C_t} = \frac{1}{C_t} - \beta^2 (1+r)^2 \frac{1}{C_{t+2}} \quad (10.25)$$

$$\frac{\partial U}{\partial C_{t+1}} = \beta \frac{1}{C_{t+1}} - \beta^2 (1+r) \frac{1}{C_{t+2}} \quad (10.26)$$

In these first order conditions, we have noted that the argument inside the third period flow utility function is just C_{t+2} . Setting each of these derivatives to zero and simplifying:

$$\frac{1}{C_t} = \beta^2(1+r)^2 \frac{1}{C_{t+2}} \quad (10.27)$$

$$\frac{1}{C_{t+1}} = \beta(1+r) \frac{1}{C_{t+2}} \quad (10.28)$$

From (10.28), we can see that $\frac{1}{C_{t+2}} = \frac{1}{\beta(1+r)} \frac{1}{C_{t+1}}$. Plugging this into (10.27) gives:

$$\frac{1}{C_t} = \beta(1+r) \frac{1}{C_{t+1}} \quad (10.29)$$

Expressions (10.29) and (10.28) are the two Euler equations for the two sets of adjacent periods. We can use these conditions to solve for C_{t+2} and C_{t+1} in terms of C_t . In particular, from (10.29), we have:

$$C_{t+1} = \beta(1+r)C_t \quad (10.30)$$

From (10.27), we have:

$$C_{t+2} = \beta^2(1+r)^2 C_t \quad (10.31)$$

Now, we can plug (10.31) and (10.30) into the intertemporal budget constraint, (10.23), leaving only C_t on the left hand side:

$$C_t + \frac{\beta(1+r)C_t}{1+r} + \frac{\beta^2(1+r)^2 C_t}{(1+r)^2} = Y_t + \frac{Y_{t+1}}{1+r} + \frac{Y_{t+2}}{(1+r)^2} \quad (10.32)$$

We can then solve for C_t as:

$$C_t = \frac{1}{1 + \beta + \beta^2} \left[Y_t + \frac{Y_{t+1}}{1+r} + \frac{Y_{t+2}}{(1+r)^2} \right] \quad (10.33)$$

Here, C_t is proportional to the present discounted value of lifetime income in a way that looks very similar to the consumption function with log utility in the two period case. What is different is that the MPC is smaller than in the two period case due to the addition of the extra β^2 term in the denominator of the proportionality constant.

To go from Euler equations to consumption function, one can combine the Euler equations with the intertemporal budget constraint to solve for C_t alone as a function of the stream

of income and the fixed interest rate. This is done in the case of log utility in the example above. To do this in the more general case, one either needs to make an assumption on the utility function, or an assumption on the relative magnitudes of β and $1 + r$. Let's go with the latter. In particular, let's assume that $\beta(1 + r) = 1$. If this is the case, this implies that the household wants to equate the marginal utilities of consumption across time. But if there is no uncertainty, this then implies equating consumption across time. In other words, if $\beta(1 + r) = 1$, then the household will desire constant consumption across time – it will want $C_t = C_{t+1} = C_{t+2} = \dots C_{t+T}$. Let's denote this fixed value of consumption by \bar{C} .

One can think about the intuition for the constant desired level of consumption under this restriction as follows. $\beta < 1$ incentivizes the household to consume in the present at the expense of the future – this would lead to declining consumption over time. $r > 0$ works in the opposite direction – it incentivizes the household to defer consumption to the future, because the return on saving is high. If $\beta(1 + r) > 1$, then the household will want the marginal utility of consumption to decline over time, which means that consumption will be increasing. In other words, with this restriction the benefit to deferring consumption (i.e. r) is smaller than the cost of deferring consumption, which is governed by β . In contrast, if $\beta(1 + r) < 1$, then the household will want the marginal utility of consumption to increase over time, which means that consumption will be declining. If $\beta(1 + r) > 1$, it means that the household is either sufficiently patient (β big) and/or the return to saving is sufficiently big (r high) that it pays to defer consumption to the future. If $\beta(1 + r) < 1$, then the household is either sufficiently impatient (β small) and/or the return to saving is sufficiently low (r low) that the household would prefer to frontload consumption. If $\beta(1 + r) = 1$, then the incentive to consume now at the expense of the present ($\beta < 1$) is offset by the incentive to defer consumption to the future ($r > 0$), and the household desires a constant level of consumption.

If consumption is constant across time, at \bar{C} , then the level of consumption can be factored out of the intertemporal budget constraint, (10.5) leaving:

$$\bar{C} \left[1 + \frac{1}{1+r} + \frac{1}{(1+r)^2} + \dots + \frac{1}{(1+r)^T} \right] = Y_t + \frac{Y_{t+1}}{1+r_t} + \frac{Y_{t+2}}{(1+r)^2} + \dots + \frac{Y_{t+T}}{(1+r)^T} \quad (10.34)$$

Since we have assumed that $\beta(1 + r) = 1$, then $\frac{1}{1+r} = \beta$. This means that we can write (10.34) as:

$$\bar{C} [1 + \beta + \beta^2 + \dots + \beta^T] = Y_t + \beta Y_{t+1} + \beta^2 Y_{t+2} + \dots + \beta^T Y_{t+T} \quad (10.35)$$

A useful mathematical fact, derived in the Mathematical Diversion below, is that:

$$1 + \beta + \beta^2 + \dots + \beta^T = \frac{1 - \beta^{T+1}}{1 - \beta} \quad (10.36)$$

If T is sufficiently big (or β sufficiently small), then β^{T+1} is approximately zero, and this works out to simply $\frac{1}{1-\beta}$. This means that we solve for the constant level of consumption as:

$$\bar{C} = \frac{1 - \beta}{1 - \beta^{T+1}} [Y_t + \beta Y_{t+1} + \beta^2 Y_{t+2} + \dots + \beta^T Y_{t+T}] \quad (10.37)$$

In this expression, consumption is constant across time and is proportional to the present discounted value of the stream of income, where the constant of proportionality is given by $\frac{1-\beta}{1-\beta^{T+1}}$.

Mathematical Diversion

Suppose you have a discounted sum, where $0 < \beta < 1$:

$$S = 1 + \beta + \beta^2 + \dots + \beta^T \quad (10.38)$$

Multiply both sides of (10.38) by β :

$$S\beta = \beta + \beta^2 + \beta^3 + \dots + \beta^{T+1} \quad (10.39)$$

Subtract (10.39) from (10.38):

$$S(1 - \beta) = 1 - \beta^{T+1} \quad (10.40)$$

In doing this subtraction, all but the first term of S and the negative of the last term of $S\beta$ cancel out. We can then solve for S as:

$$S = \frac{1 - \beta^{T+1}}{1 - \beta} \quad (10.41)$$

This is the same expression presented in the main text, (10.36).

10.2 The MPC and Permanent vs. Transitory Changes in Income

Suppose that $\beta(1+r) = 1$ so that the consumption function is given by (10.37). We can calculate the marginal propensity to consume, $\frac{\partial \bar{C}}{\partial Y_t}$, as:

$$\frac{\partial \bar{C}}{\partial Y_t} = \frac{1 - \beta}{1 - \beta^{T+1}} \quad (10.42)$$

This MPC is positive and less than one, because $\beta^{T+1} < \beta$. Only if $T = 0$ (i.e. the household only lives for one period) would the MPC be equal to one. Further, the MPC will be smaller the bigger is T – the bigger is T , the smaller is β^{T+1} , and hence the bigger is $1 - \beta^{T+1}$. In other words, the longer the household expects to live, the smaller ought to be its MPC. This has obvious policy implications in a world where you have households who are different ages (i.e. have more or less remaining periods of life). We sometimes call such setups overlapping generations models. We would expect younger people (i.e. people with bigger T) to have larger MPCs than older folks (i.e. people with smaller T).

The intuition for why the MPC is decreasing in T is straightforward. If the household desires constant consumption, it has to increase its saving in a period where income is high in order to increase consumption in other periods where income is not higher. The more periods where consumption needs to increase when income is not higher, the more the household has to increase its saving in the period where income increases. Hence, in response to a one period increase in income the household increases its consumption by less the bigger is T .

The partial derivative of the constant value of consumption with respect to income received j periods from now is:

$$\frac{\partial \bar{C}}{\partial Y_{t+j}} = \beta^j \frac{1 - \beta}{1 - \beta^{T+1}} \quad (10.43)$$

If $j = 0$, then this reduces to (10.42). The bigger is j , the smaller is β^j . In (10.37), consumption in each period is equal to a proportion of the present discounted value of flow utility. The further off in time extra income is going to accrue, the smaller the effect this has on the present discounted value of the stream of income, since $\beta < 1$. This means that the household adjusts its consumption less to an anticipated change in future income the further out into the future is that anticipated change in income.

If T is sufficiently large (i.e. the household lives for a sufficiently long period of time), then $\beta^{T+1} \approx 0$, and we can approximate the MPC with $1 - \beta$. If β is large (i.e. relatively close to 1), then the MPC can be quite small. For example, if $\beta = 0.95$ and T is sufficiently big, then the MPC is only 0.05. In other words, when the household lives for many periods, the MPC is not only less than 1, it ought to be quite close to 0. A household ought to save the majority of any extra income in period t , which is necessary to finance higher consumption in the future.

To think about the distinction between permanent and transitory changes in income, we can take the total derivative of the consumption function, (10.37). This is:

$$d\bar{C} = \frac{1 - \beta^{T+1}}{1 - \beta} [dY_t + \beta dY_{t+1} + \beta^2 dY_{t+2} + \dots + \beta^T dY_{t+T}] \quad (10.44)$$

For a transitory change in income, we have $dY_t > 0$ and $dY_{t+j} = 0$, for $j > 0$. Then the effect of a transitory change in income on the fixed level of consumption is just the MPC:

$$\frac{d\bar{C}}{dY_t} = \frac{1 - \beta^{T+1}}{1 - \beta} \quad (10.45)$$

Next, consider a permanent change in income, where $dY_t > 0$ and $dY_{t+j} = dY_t$ for $j > 0$. If income changes by the same amount in all future periods, then we can factor this out, which means we can write (10.44) as:

$$d\bar{C} = \frac{1 - \beta^{T+1}}{1 - \beta} dY_t [1 + \beta + \beta^2 + \dots + \beta^T] \quad (10.46)$$

From (10.36), we know that the term remaining in brackets in (10.46) is $\frac{1-\beta}{1-\beta^{T+1}}$. This then cancels with the first term, leaving:

$$\frac{d\bar{C}}{dY_t} = 1 \quad (10.47)$$

In other words, if $\beta(1+r) = 1$, then a household ought to spend all of a permanent change in income, with no adjustment in saving behavior. Intuitively, the household wants a constant level of consumption across time. If income increases by the same amount in all periods, the household can simply increase its consumption in all periods by the same amount without adjusting its saving behavior.

The analysis here makes the distinction between transitory and permanent changes in income from the two period model even starker. The MPC out of a transitory change in income ought to be very small, while consumption ought to react one-to-one to a permanent change in income.

One can see this distinction between transitory and permanent changes in income even more cleanly if, in addition to assuming that $\beta(1+r) = 1$, we further assume that $\beta = 1$ (and hence $r = 0$). In this case, the household still desires a constant level of consumption across time. But the intertemporal budget constraint just works out to the sum of consumption being equal to the sum of income. Hence, the consumption function becomes:¹

$$\bar{C} = \frac{1}{T+1} [Y_t + Y_{t+1} + Y_{t+2} + \dots + Y_{t+T}] \quad (10.48)$$

¹One would be tempted to look at (10.37), plug in $\beta = 1$, and conclude that it is undefined, since $1 - \beta = 0$ and $1 - \beta^{T+1} = 0$ if $\beta = 1$. $0/0$ is undefined, but one can use L'Hopital's rule to determine that $\lim_{\beta \rightarrow 1} \frac{1-\beta}{1-\beta^{T+1}} = \frac{1}{T+1}$.

In other words, in (10.48) consumption is simply equal to average lifetime income $- T + 1$ is the number of periods the household lives, and the term in brackets is the sum of income across time. If T is sufficiently large, then a transitory change in income has only a small effect on average lifetime income, and so consumption reacts little. If there is a permanent change in income, then average income increases by the increase in income, and so the household consumes all of the extra income.

Example

Suppose that the household lives for 100 periods, so $T = 99$. Suppose it initially has income of 1 in each period. This means that average lifetime income is 1, so consumption is equal to 1 and is constant across time. Suppose that income in period t goes up to 2. This raises average lifetime income to $\frac{101}{100}$, or 1.01. So consumption will increase by 0.01 in period t and all subsequent periods. The household increases its saving in period t by 0.99 ($2 - 1.01$). This extra saving is what allows the household to achieve higher consumption in the future.

In contrast, suppose that income goes up from 1 to 2 in each and every period of life. This raises average lifetime income to 2. Hence, consumption in each period goes up by 1, from 1 to 2. There is no change in saving behavior.

10.3 The Life Cycle

We can use our analysis based on the assumption that $\beta(1+r) = 1$, which gives rise to constant consumption across time given by (10.37), to think about consumption and saving behavior over the life-cycle.

In particular, suppose that a household enters adulthood in period t . It expects to retire after period $t + R$ (so R is the retirement date) and expects to die after period $t + T$ (so T is the death date). Suppose that it begins its working life with Y_t units of income. Up until the retirement date, it expects its income to grow each period by *gross growth rate* $G_Y \geq 0$. In terms of the net growth rate, we have $G_Y = 1 + g_Y$, so $G_Y = 1$ would correspond to the case of a flat income profile. After date $t + R$, it expects to earn income level Y^R , which we can think about as a retirement benefit. This benefit is expected to remain constant throughout retirement.

Under these assumptions, we can solve for the constant level of consumption across time, \bar{C} , as follows:

$$\bar{C} = \frac{1-\beta}{1-\beta^{T+1}} [Y_t + \beta G_Y Y_t + \beta^2 G_Y^2 Y_t + \dots + \beta^R G_Y^R Y_t + \beta^{R+1} Y^R + \beta^{R+2} Y^R + \dots + \beta^T Y^R] \quad (10.49)$$

(10.49) can be simplified as follows:

$$\bar{C} = \frac{1-\beta}{1-\beta^{T+1}} Y_t [1 + \beta G_Y + (\beta G_Y)^2 + \dots + (\beta G_Y)^R] + \frac{1-\beta}{1-\beta^{T+1}} \beta^{R+1} Y^R [1 + \beta + \dots + \beta^{T-R-1}] \quad (10.50)$$

This can be simplified further by noting that:

$$1 + \beta G_Y + (\beta G_Y)^2 + \dots + (\beta G_Y)^R = \frac{1 - (\beta G_Y)^{R+1}}{1 - \beta G_Y} \quad (10.51)$$

$$1 + \beta + \dots + \beta^{T-R-1} = \frac{1 - \beta^{T-R}}{1 - \beta} \quad (10.52)$$

We can these plug these expressions in to get:

$$\bar{C} = \frac{1-\beta}{1-\beta^{T+1}} \frac{1 - (\beta G_Y)^{R+1}}{1 - \beta G_Y} Y_t + \frac{1-\beta}{1-\beta^{T+1}} \beta^{R+1} \frac{1 - \beta^{T-R}}{1 - \beta} Y^R \quad (10.53)$$

(10.53) is the consumption function. Note that if $T = R$ (i.e. if the household retires the same period it dies, so that there is no retirement period), then $\beta^{T-R} = \beta^0 = 1$, so the last term drops out. We can see that consumption is clearly increasing in (i) initial income, Y_t , and (ii) the retirement benefit, Y^R . It is not as straightforward to see, but consumption is also increasing in the growth rate of income during working years, g_Y . As long as the retirement benefit is not too big relative to income during lifetime (i.e. Y^R isn't too large), consumption will be increasing in R (i.e. a household will consume more the longer it plans to work).

Figure 10.1 plots hypothetical time paths for consumption and income across the life cycle. We assume that income starts out low, but then grows steadily up until the retirement date. Income drops substantially at retirement to Y^R . The consumption profile is flat across time – this is a consequence of the assumption that $\beta(1+r) = 1$.

Figure 10.1: Consumption and Income: The Life Cycle

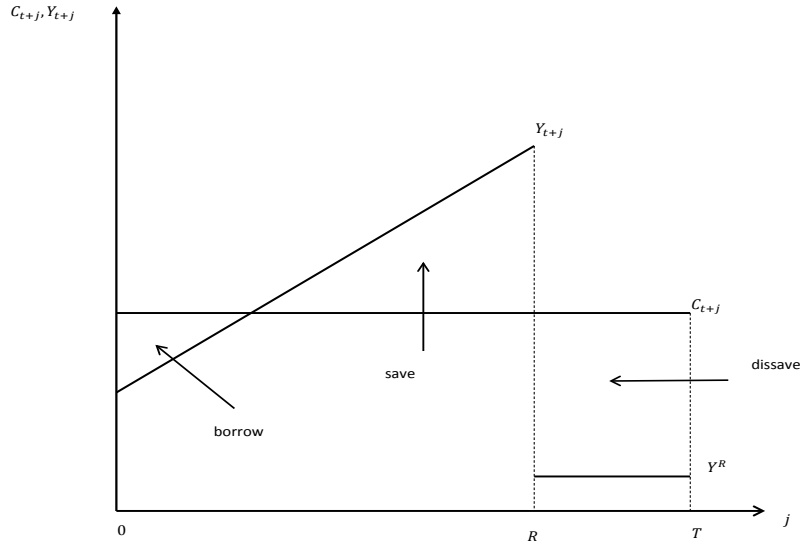

Within the figure, we indicate how the household’s saving behavior should look over the life cycle. Early in life, income is low relative to future income. Effectively, one can think that current income is less than average income. This means that consumption ought to be greater than income, which means that the household is borrowing. During “prime working years,” which occur during the middle of life when income is high, the household ought to be saving. At first, this saving pays off the accumulated debt from early in life. Then, this saving builds up a stock of savings, which will be used to finance consumption during retirement when income falls.

Figure 10.2 plots a hypothetical stock of savings over the life cycle which accords with the consumption and income profiles shown in Figure 10.1. The stock of savings begins at zero, by assumption that the household begins its life with no wealth. The stock of savings grows negative (i.e. the household goes into debt for a number of periods). Then the stock of savings starts to grow, but remains negative. During this period, the household is paying down its accumulated debt. During the middle of life, the stock of savings turns positive and grows, reaching a peak at the retirement date. The stock of savings then declines as the household draws down its savings during retirement years. The household dies with a zero stock of savings – this is simply a graphical representation of the terminal condition which we used to get the intertemporal budget constraint.

Figure 10.2: The Stock of Savings over The Life Cycle

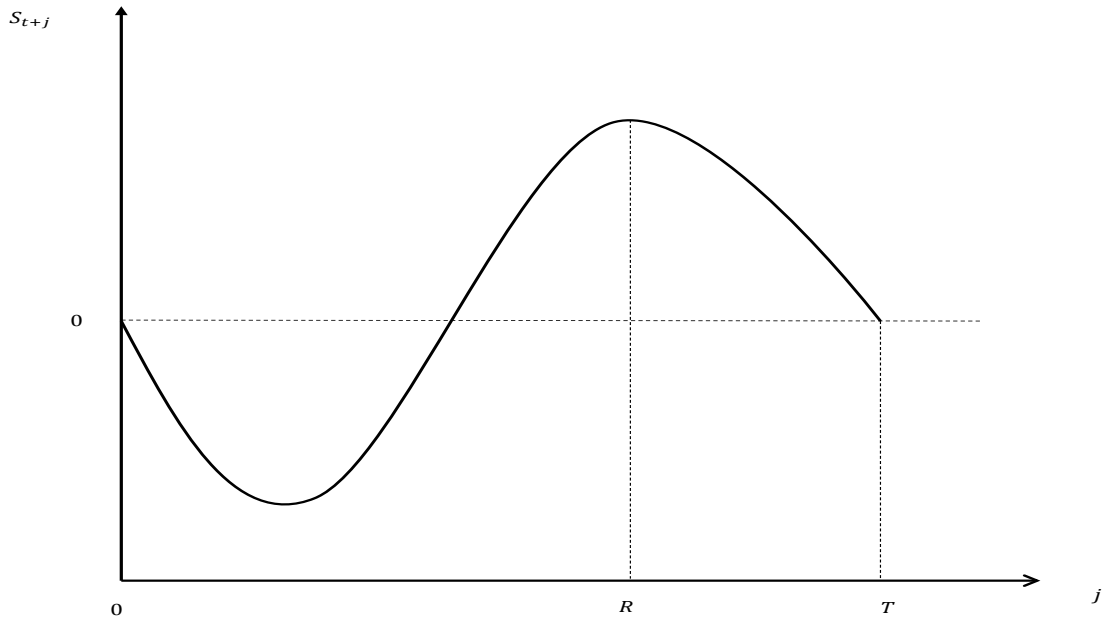

It is important to note that the time paths of income, consumption, and savings in Figures 10.1 and 10.2 are hypothetical. The only general conclusion is that the consumption profile ought to be flat (under the assumption that $\beta(1+r) = 1$). Whether the household ever borrows or not depends on the income profile – if income grows slowly enough, or if the retirement period is long enough, the household may immediately begin life by doing positive saving. The key points are that consumption ought to be flat and savings ought to peak at retirement.

Empirical Evidence

The basic life cycle model laid out above predicts that consumption ought not to drop at retirement. This is an implication of the PIH which we studied in Chapter 9. Retirement is (more or less) predictable, and therefore consumption plans ought to incorporate the predictable drop in income at retirement well in advance. This prediction does not depend on the assumption that $\beta(1+r) = 1$ and that the consumption profile is flat. One could have $\beta(1+r) > 1$, in which case consumption would be steadily growing over time, or $\beta(1+r) < 1$, in which case consumption would be declining over time. Relative to its trend (flat, increasing, or decreasing) consumption should not react to a predictable change in income like at retirement.

The so-called “retirement consumption puzzle” documents that consumption expenditure drops significantly at retirement. This is not consistent with the implications of the basic theory. [Aguiar and Hurst \(2005\)](#) note that there is a potentially important distinction between consumption and expenditure. In the data, we measure total dollar expenditure on goods. We typically call this consumption. But it seems plausible that people who are more efficient consumers (for example, they find better deals at stores) might have lower expenditure than a less efficient consumer, even if consumption is the same.

At retirement, the opportunity cost of one’s time goes down significantly. Relative to those actively working, retired persons spend more time shopping (e.g. clipping coupons, searching for better deals), cook more meals at home relative to eating out, etc.. All of these things suggest that their expenditure likely goes down relative to their actual consumption. [Aguiar and Hurst \(2005\)](#) use a novel data set to measure caloric intake for individuals, and find that there is no drop in caloric intake at retirement, though expenditure on food drops. They interpret this evidence as being consistent with the predictions of the life cycle model.

10.4 Summary

- In a multi-period context the difference between “savings” and “saving” becomes important. The former is a stock variable, whereas the latter is a flow variable. If the consumer’s current consumption is less than their current income, then saving is positive and adds to their savings.
- The lifetime budget constraint is derived by combining all the sequential budget constraints. Like the two-period case, the present discounted value of consumption equals the present discounted value of income.
- The marginal propensity to consume out of current income is decreasing the longer individuals are expected to live. This has the implication that the marginal propensity to consume out of tax cuts should be higher for older workers.
- The marginal propensity to consume out of future income is decreasing in the number of periods before the income gain is realized.
- The life cycle model predicts that consumers will borrow early in life when current earnings are below average lifetime earnings, save in midlife when current earnings are above average lifetime earnings, and dissave during retirement.

Key Terms

- Saving and savings

Questions for Review

1. What is the terminal condition in a multi-period model? Explain why this terminal condition makes sense.
2. Write down the Euler equation. What is the economic interpretation on this equation?
3. An old person and young person both win a lottery worth the same dollar value. According to the life cycle model, whose current consumption will increase by more? How do you know?
4. Describe why a permanent change in taxes has a larger effect on consumption than a one-time change in taxes.
5. Suppose the generosity of social security benefits increase. How would this affect the consumption of someone in their prime working years?

Exercises

1. Suppose that a household lives for three periods. Its lifetime utility is:

$$U = \ln C_t + \beta \ln C_{t+1} + \beta^2 \ln C_{t+2}$$

It faces the following sequence of flow budget constraints (which we assume hold with equality):

$$C_t + S_t = Y_t$$

$$C_{t+1} + S_{t+1} = Y_{t+1} + (1 + r_t)S_t$$

$$C_{t+2} + S_{t+2} = Y_{t+2} + (1 + r_{t+1})S_{t+1}$$

Note that we are not imposing that the interest rate on saving/borrowing between period t and $t + 1$ (i.e. r_t) is the same as the rate between $t + 1$ and $t + 2$ (i.e. r_{t+1}).

- (a) What will the terminal condition on savings be? In other words, what value should S_{t+2} take? Why?

- (b) Use this terminal condition to collapse the three flow budget constraints into one intertemporal budget constraint. Argue that the intertemporal budget constraint has the same intuitive interpretation as in the two period model.
- (c) Solve for C_{t+2} from the intertemporal budget constraint, transforming the problem into an unconstrained one. Derive two Euler equations, one relating C_t and C_{t+1} , and the other relating C_{t+1} and C_{t+2} .
- (d) Use these Euler equations in conjunction with the intertemporal budget constraint to solve for C_t as a function of Y_t, Y_{t+1}, Y_{t+2}, r .
- (e) Derive an expression for the marginal propensity to consume, i.e. $\frac{\partial C_t}{\partial Y_t}$. Is this larger or smaller than in the two period case with the same consumption function? What is the intuition for your answer?
- (f) Derive an expression for the effect of r on C_t – i.e. derive an expression $\frac{\partial C_t}{\partial r}$. Under what condition is this negative?

2. **Life Cycle / Permanent Income Consumption Model [Excel Problem]** Suppose that we have a household that lives for $T + 1$ periods, from period 0 to period T . Its lifetime utility is:

$$U = u(C_0) + \beta u(C_1) + \beta^2 u(C_2) + \dots + \beta^T u(C_T)$$

$$U = \sum_{t=0}^T \beta^t u(C_t)$$

The household has a sequence of income, Y_0, Y_1, \dots, Y_T , which it takes as given. The household can borrow or lend at constant real interest rate r , with $r > 0$. The household faces a sequence of period budget constraints:

$$\begin{aligned} C_0 + S_0 &= Y_0 \\ C_1 + S_1 &= Y_1 + (1+r)S_0 \\ C_2 + S_2 &= Y_2 + (1+r)S_1 \\ &\vdots \\ C_T &= Y_T + (1+r)S_{T-1} \end{aligned}$$

Here $S_t, t = 0, 1, \dots, T$ is the *stock* of savings that the household takes from period t to period $t+1$. The flow, saving, is defined as the change in the stock,

or $S_t - S_{t-1}$ (hence, in period 0, the flow and the stock are the same thing). The sequence of budget constraints can be combined into the intertemporal budget constraint:

$$C_0 + \frac{C_1}{1+r} + \frac{C_2}{(1+r)^2} + \cdots + \frac{C_T}{(1+r)^T} = Y_0 + \frac{Y_1}{1+r} + \frac{Y_2}{(1+r)^2} + \cdots + \frac{Y_T}{(1+r)^T}$$

$$\sum_{t=0}^T \frac{C_t}{(1+r)^t} = \sum_{t=0}^T \frac{Y_t}{(1+r)^t}$$

Once can show that there are T different optimality conditions, satisfying:

$$u'(C_t) = \beta(1+r)u'(C_{t+1}) \quad \text{for } t = 0, 1, \dots, T-1$$

- (a) Provide some intuition for this sequence of optimality conditions.
- (b) Assume that $\beta(1+r) = 1$. What does this imply about consumption across time? Explain.
- (c) Assume that $r = 0.05$. What must β be for the restriction in (b) to be satisfied?
- (d) Using your answer from (b), solve for an analytic expression for consumption as a function of r and the stream of income.
- (e) Now create an Excel file to numerically analyze this problem. Suppose that income grows over time. In particular, let $Y_t = (1+g_y)^t Y_0$ for $t = 0, 1, \dots, T$. Suppose that $g_y = 0.02$ and that $Y_0 = 10$. Assume that $T = 50$. Use this, in conjunction with the value of r from (c), to numerically solve for the time path of consumption. Create a graph plotting consumption and income against time.
- (f) Given your time series of consumption and income, create a time series of savings (stock) and saving (flow). In period t , $t = 0, 1, \dots, T$, your savings should be the stock of savings that the household leaves that period with (they enter period 0 with nothing, but leave with something, either positive or negative). Create a graph plotting the time series of

savings. What is true about the stock of savings that the household leaves over after period T ?

- (g) Are there periods in which your flow saving variable is negative/positive but consumption is less than/greater than income? If so, what accounts for this? Explain.

- (h) Now modify the basic problem such that the household retires at date $R < T$. In particular, assume that the income process is the same as before, but goes to zero at date $R + 1$: $Y_t = (1 + g_y)^t Y_0$ for $t = 0, 1, \dots, R$. Re-do the Excel exercise assuming that $R = 39$, so that income goes to 0 in period 40. Show the plot of consumption and income against time, and also plot the time series behavior of the stock of savings. Comment on how the life cycle of savings is affected by retirement.

- (i) One popular proposal floating around right now is to raise the retirement age in the hope of making Social Security solvent. Suppose that the retirement age were increased by five years, from $R = 39$ to $R = 44$. What effect would this have on consumption? Other things being equal, do you think this change would be good or bad for the economy in the short run?

Chapter 11

Equilibrium in an Endowment Economy

In Chapter 9, we studied optimal consumption-saving behavior in a two period framework. In this framework, the household takes the real interest rate as given. In this Chapter, we introduce an equilibrium concept in a world in which the household behaves optimally, but its income is exogenously given. We refer to this setup as equilibrium in an endowment economy. We call it an endowment economy to differentiate it from a production economy, where the total amount of income available for a household to consume and/or save is endogenously determined.

11.1 Model Setup

Suppose that there are many households in an economy. We index these households by j and suppose that the total number of households is L . For example, consumption in period t of the j^{th} household is denoted $C_t(j)$. We assume that L is sufficiently large that these households behave as price-takers. These households live for two periods, t (the present) and $t + 1$ (the future). Each period, they earn an exogenous amount of income, $Y_t(j)$ and $Y_{t+1}(j)$. For simplicity, assume that there is no uncertainty. They begin life with no wealth. They can save or borrow in period t at a common real interest rate, r_t . Because they behave as price-takers, they take r_t as given.

All households have the same preferences. Lifetime utility for household j is:

$$U(j) = u(C_t(j)) + \beta u(C_{t+1}(j)) \quad (11.1)$$

The period utility function has the same properties outlined in Chapter 9. Household j faces the sequence of period budget constraints:

$$C_t(j) + S_t(j) \leq Y_t(j) \quad (11.2)$$

$$C_{t+1}(j) + S_{t+1}(j) \leq Y_{t+1}(j) + (1 + r_t)S_t(j) \quad (11.3)$$

Imposing that these budget constraints both hold with equality, and imposing the terminal

condition that $S_{t+1}(j) = 0$, we arrive at the intertemporal budget constraint:

$$C_t(j) + \frac{C_{t+1}(j)}{1+r_t} = Y_t(j) + \frac{Y_{t+1}(j)}{1+r_t} \quad (11.4)$$

The household's problem is to choose $C_t(j)$ and $C_{t+1}(j)$ to maximize (11.1) subject to (11.4). Since this is the same setup encountered in Chapter 9, the optimality condition is the familiar Euler equation:

$$u'(C_t(j)) = \beta(1+r_t)u'(C_{t+1}(j)) \quad (11.5)$$

Since all agents in the economy face the same real interest rate, r_t , and the Euler equation must hold for all agents, it follows that $\frac{u'(C_t(j))}{\beta u'(C_{t+1}(j))}$ must be the same for all agents. Effectively, this means that all agents will have the same expected growth rate of consumption, but the levels of consumption need not necessarily be the same across agents. Qualitatively, the Euler equation can be combined with the intertemporal budget constraint to yield a qualitative consumption function of the sort:

$$C_t(j) = C^d(Y_t(j), Y_{t+1}(j), r_t) \quad (11.6)$$

Consumption is increasing in current and future income, and decreasing in the real interest rate. The partial derivative of the consumption function with respect to the first argument, $\frac{\partial C^d(\cdot)}{\partial Y_t}$, is positive but less than one. We continue to refer to this as the marginal propensity to consume, or MPC.

11.2 Competitive Equilibrium

Though each agent takes the real interest rate as given, in the aggregate the real interest rate is an endogenous variable determined as a consequence of equilibrium. We will define an important concept called a *competitive equilibrium* as follows: a competitive equilibrium is a set of prices and quantities for which all agents are behaving optimally and all markets simultaneously clear. The price in this economy is r_t , the real interest rate. We can interpret this as an intertemporal price of goods – r_t tells you how much future consumption one can acquire by foregoing some current consumption. The quantities are values of $C_t(j)$ and $C_{t+1}(j)$. One could also think of saving, $S_t(j)$, as an equilibrium outcome.

What does it mean for “markets to clear” in this context? Loosely speaking, you can think about markets clearing as supply equaling demand. The one market in this economy is the market for bonds – a household decides how much it wants to save, $S_t(j) > 0$, or borrow, $S_t(j) < 0$, given r_t . In the aggregate, saving must be zero in this economy. Mathematically,

the sum of $S_t(j)$ across households must equal zero:

$$\sum_{j=1}^L S_t(j) = 0 \quad (11.7)$$

Why must this be the case? Consider a world where $L = 2$. Suppose that one household wants to borrow, with $S_t(1) = -1$. Where are the funds for this loan to come from? They must come from the second household, who must have $S_t(2) = 1$. If $S_t(2) \neq 1$, then there would either be too much (or too little) saving for household 1 to borrow one unit. Hence, it must be the case that aggregate saving is equal to zero in this economy. This would not hold if the model featured capital (like in the Solow model), where it is possible to transfer resources across time through the accumulation of capital.

Suppose that the first period budget constraint holds with equality for all agents. Then, summing (11.2) across all L agents, we get:

$$\sum_{j=1}^L C_t(j) + \sum_{j=1}^L S_t(j) = \sum_{j=1}^L Y_t(j) \quad (11.8)$$

Now, define $C_t = \sum_{j=1}^L C_t(j)$ and $Y_t = \sum_{j=1}^L Y_t(j)$ as aggregate consumption and income, respectively. Imposing the market-clearing condition that aggregate saving equals zero yields the aggregate resource constraint:

$$C_t = Y_t \quad (11.9)$$

In other words, in the aggregate, consumption must equal income in this economy. This is again an artifact of the assumption that there is no production in this economy, and hence no way to transfer resources across time through investment (i.e. $I_t = 0$).

Effectively, one can think about equilibrium in this economy as follows. Given exogenous values of $Y_t(j)$ and $Y_{t+1}(j)$, and given an interest rate, r_t , each household determines its consumption via (11.6). The real interest rate, r_t , must adjust so that each household setting its consumption according to its consumption function is consistent with aggregate consumption equaling aggregate income.

11.3 Identical Agents and Graphical Analysis of the Equilibrium

We have already assumed that all agents have identical preferences (i.e. they all have the same β and same flow utility function). In addition, let us further assume that they all face the same income stream – i.e. $Y_t(j)$ and $Y_{t+1}(j)$ are the same for all j . To simplify matters even further, let us normalize the total number of households to $L = 1$. This means that

$Y_t(j) = Y_t$ and $C_t(j) = C_t$ for all agents. This may seem a little odd. If $L > 1$, consumption and income of each type of agent would equal *average* aggregate consumption and income. But since we have normalized $L = 1$, the average of the aggregates is equal to what each individual household does.

With all agents the same, optimality requires that:

$$C_t = C^d(Y_t, Y_{t+1}, r_t) \quad (11.10)$$

Market-clearing requires that $S_t = 0$. Since all agents are the same, this means that, in equilibrium, no household can borrow or save. Intuitively, the reason for this is straightforward. If one agent wanted to borrow, then all agents would want to borrow (since they are all the same). But this can't be, since one agent's borrowing must be another's saving. Hence, in equilibrium, agents cannot borrow or save. $S_t = 0$ implies the aggregate resource constraint:

$$C_t = Y_t \quad (11.11)$$

Expressions (11.10) and (11.11) are two equations in two unknowns (since Y_t and Y_{t+1} are taken to be exogenous). The two unknowns are C_t and r_t (the quantity and the price). Effectively, the competitive equilibrium is a value of r_t such that both of these equations hold (the first requires that agents behave optimally, while the second says that markets clear). Mathematically, combining these two equations yields one equation in one unknown:

$$Y_t = C^d(Y_t, Y_{t+1}, r_t) \quad (11.12)$$

In equilibrium, r_t must adjust to make this expression hold, given exogenous values of Y_t and Y_{t+1} .

We can analyze the equilibrium of this economy graphically using the familiar tools of supply and demand. Let us focus first on the demand side, which is more interesting since there is no production in this economy. Let us introduce an auxiliary term which we will call desired aggregate expenditure, Y_t^d . Desired aggregate expenditure is simply the consumption function:

$$Y_t^d = C^d(Y_t, Y_{t+1}, r_t) \quad (11.13)$$

Desired aggregate expenditure is a function of current income, Y_t , future income, Y_{t+1} , and the real interest rate, r_t . We can graph this in a plot with Y_t^d on the vertical axis and Y_t on the horizontal axis. This means that in drawing this graph we are taking the values of Y_{t+1} and r_t as given. We assume that desired expenditure is positive even with zero current

income; that is, $C^d(0, Y_{t+1}, r_t) > 0$. The level of desired expenditure for zero current income is often times called “autonomous expenditure” (the “autonomous” refers to the fact that this represents expenditure which is autonomous, i.e. independent, of current income). As current income rises, desired expenditure rises, but at a less than one-for-one rate (since the MPC is less than one). Hence, a graph of desired expenditure against current income starts with a positive vertical intercept and is upward-sloping with slope less than one. For simplicity, we will draw this “expenditure line” as a straight line (i.e. we assume a constant MPC), though it could have curvature more generally. The expenditure line is depicted in Figure 11.1 below.

Figure 11.1: Expenditure and Income

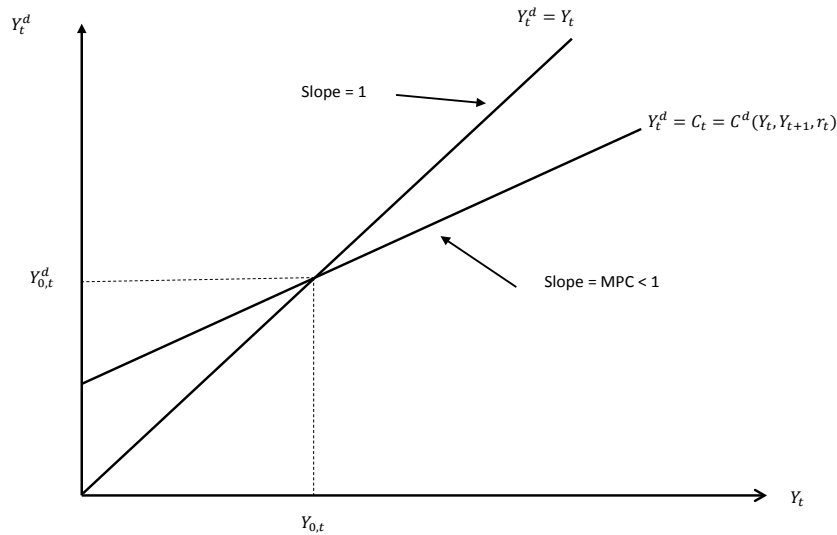

In Figure 11.1, we have drawn in a 45 degree line, which splits the plane in half, starts in the origin, has slope of 1, and shows all points where $Y_t^d = Y_t$. In equilibrium, total expenditure must equal total income. So, the equilibrium value of Y_t must be a point where the expenditure line crosses the 45 degree line. Given that we have assumed that autonomous expenditure is positive and that the MPC is less than 1, graphically one can easily see that the expenditure line must cross the 45 degree line exactly once. In the graph, this point is labeled $Y_{0,t}$.

The amount of autonomous expenditure depends on the expected amount of future income and the real interest rate, r_t . A higher value of r_t reduces autonomous expenditure, and therefore shifts the expenditure line down. This results in a lower level of Y_t where income equals expenditure. The converse is true for a lower real interest rate.

We define a curve called the IS curve as the set of (r_t, Y_t) pairs where income equals expenditure and the household behaves optimally. In words, the IS curve traces out the

combinations of r_t and Y_t for which the expenditure line crosses the 45 degree line. IS stands for investment equals saving. There is no investment and no saving in an endowment economy, so investment equaling saving is equivalent to consumption equaling income. We will also use a curve called the IS curve that looks very much like this in a more complicated economy with endogenous production and non-zero saving and investment later in the book.

We can derive the IS curve graphically as follows. Draw two graphs on top of one another, both with Y_t on the horizontal axis. The upper graph is the same as Figure 11.1, while the lower graph has r_t on the vertical axis. Start with some value of the real interest rate, call it $r_{0,t}$. Given a value of Y_{t+1} , this determines the level of autonomous expenditure (i.e. the vertical axis intercept of the expenditure line). Find the level of income where expenditure equals income, call this $Y_{0,t}$. “Bring this down” to the lower graph, giving you a pair, $(r_{0,t}, Y_{0,t})$. Then, consider a lower interest rate, $r_{1,t}$. This raises autonomous expenditure, shifting the expenditure line up. This results in a higher level of income where income equals expenditure, call it $Y_{1,t}$. Bring this point down, and you have another pair, $(r_{1,t}, Y_{1,t})$. Next, consider a higher value of the interest rate, $r_{2,t}$. This lowers autonomous expenditure, resulting in a lower value of current income where income equals expenditure. This gives you a pair $(r_{2,t}, Y_{2,t})$. In the lower graph with r_t on the vertical axis, if you connect these pairs, you get a downward-sloping curve which we call the IS curve. In general, it need not be a straight line, though that is how we have drawn it here. This is shown below in Figure 11.2.

Figure 11.2: Derivation of the IS Curve

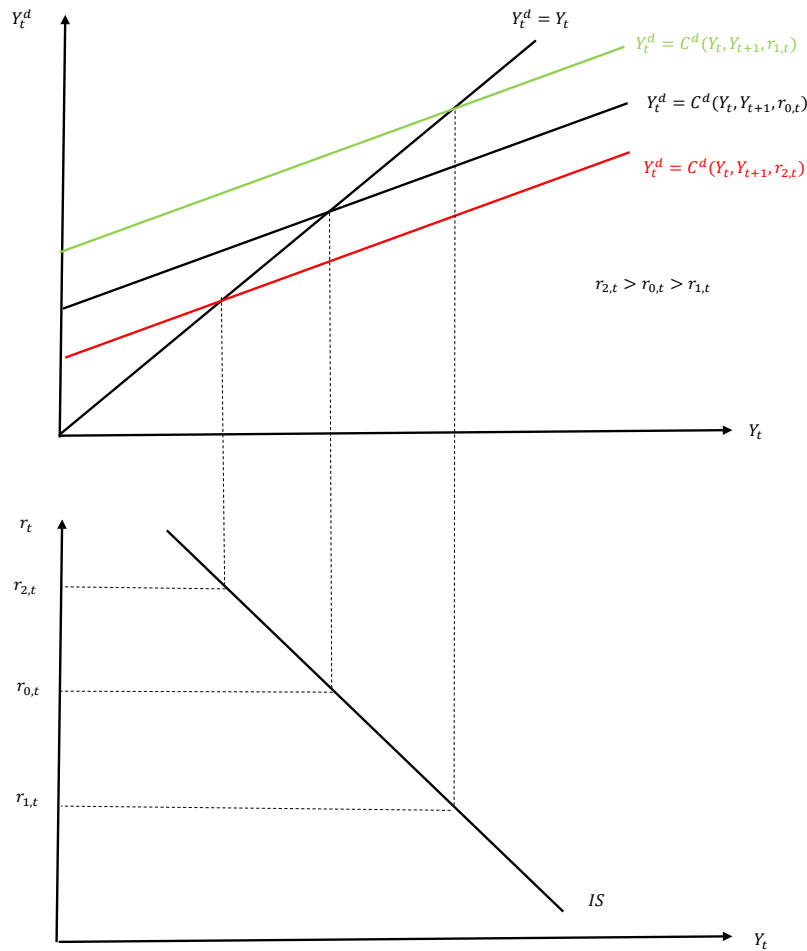

The IS curve is drawn holding Y_{t+1} fixed. Hence, changes in Y_{t+1} will cause the entire IS curve to shift to the right or to the left. Suppose that initially we have $Y_{0,t+1}$. Suppose that we are initially at a point $(r_{0,t}, Y_{0,t})$ where income equals expenditure. Suppose that future income increases to $Y_{1,t+1} > Y_{0,t+1}$. Holding the real interest rate fixed at $r_{0,t}$, the increase in future income raises autonomous expenditure, shifting the expenditure line up. This is shown in the upper panel of Figure 11.3. This upward shift of the expenditure line means that the level of current income where income equals expenditure is higher for a given real interest rate. Bringing this down to the lower graph, this means that the entire IS curve must shift to the right. A reduction in future income would have the opposite effect, with the IS curve shifting in.

Figure 11.3: IS Curve Shift: $\uparrow Y_{t+1}$

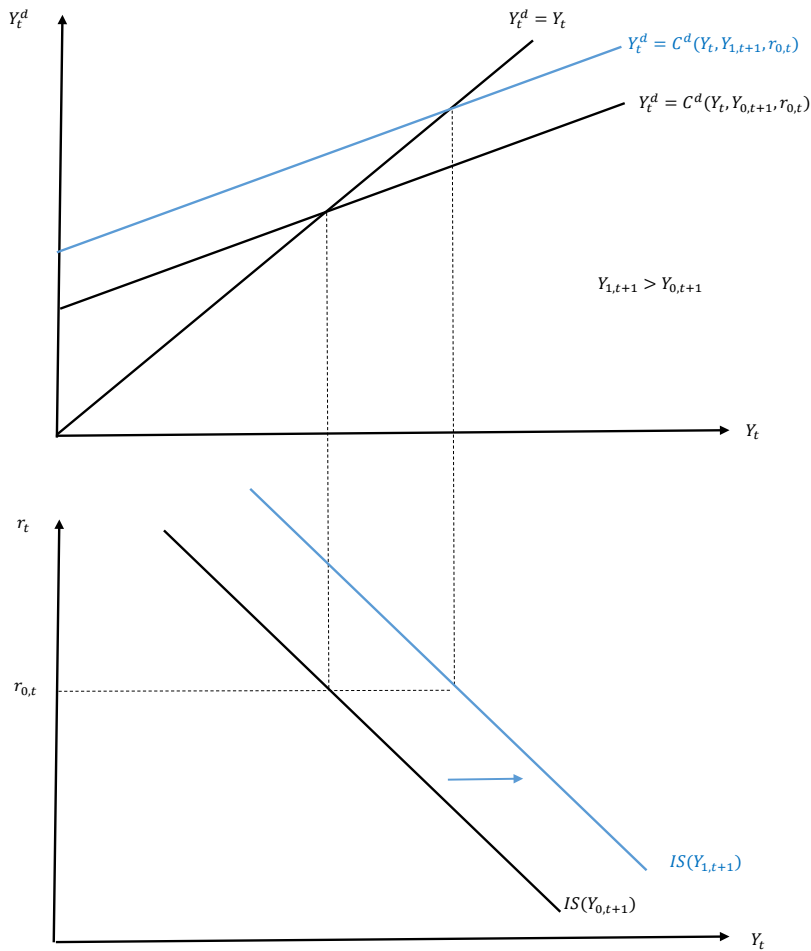

The IS curve summarizes the demand side of the economy, showing all (r_t, Y_t) points where income equals expenditure. The supply side of the economy summarizes production, which must equal both income and expenditure in equilibrium. Since we are dealing with an endowment economy where there is no production, this is particularly simple. Generically, define the Y^s curve as the set of (r_t, Y_t) pairs where agents are behaving optimally, consistent with the production technology in the economy. Since income is exogenous in an endowment economy, the Y^s curve is just a vertical line at the exogenously given level of current income, $Y_{0,t}$. This is shown below in Figure 11.4.

Figure 11.4: The Y^s Curve

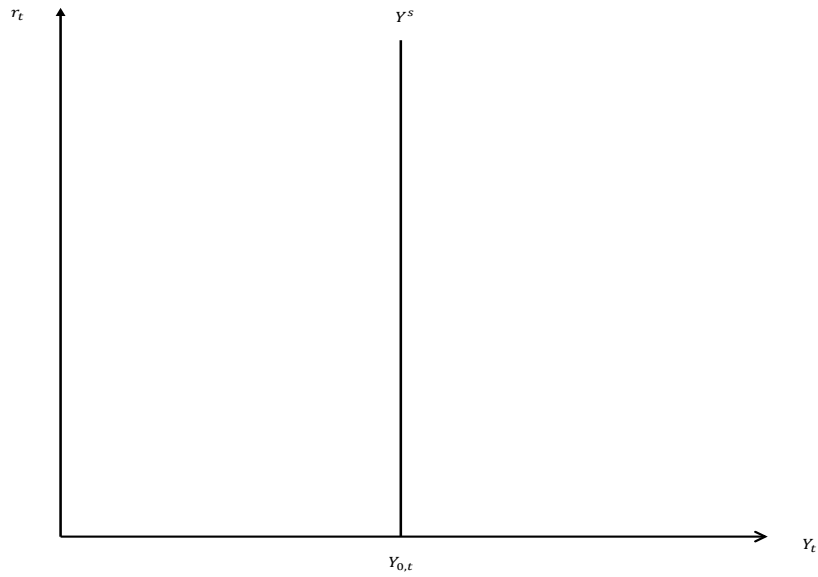

In equilibrium, the economy must be on both the Y^s and Y^d curves. This is shown in Figure 11.5 below.

Figure 11.5: Equilibrium

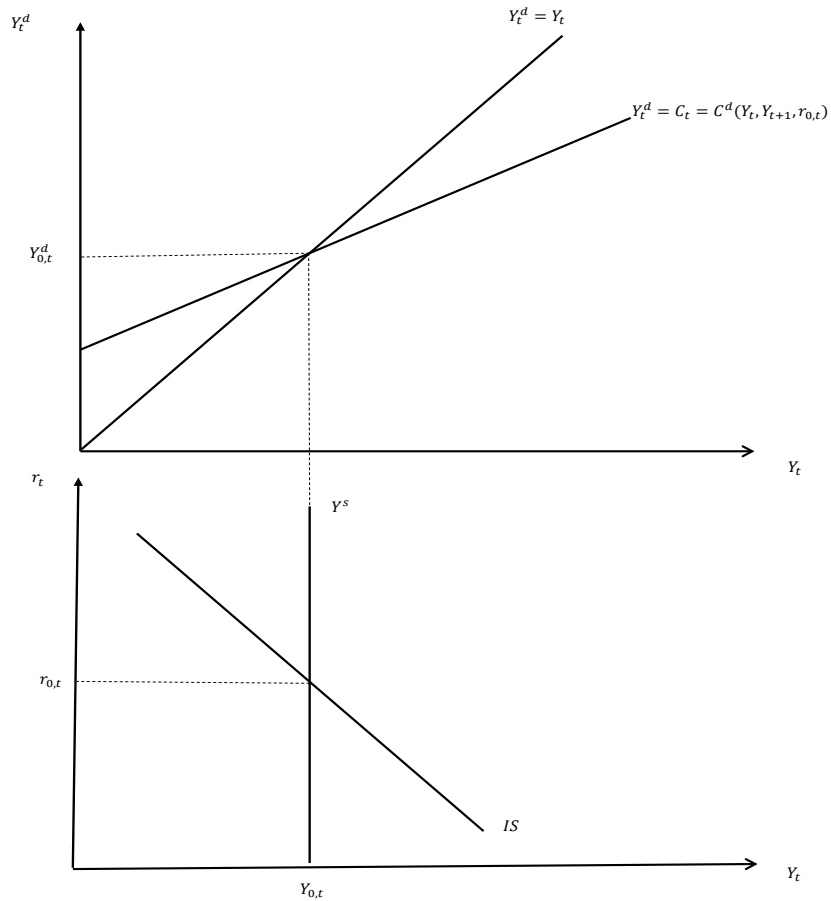

We can use the graphs in Figure 11.5 to analyze how r_t will react to changes in current and future income in equilibrium. We do so in the subsections below.

11.3.1 Supply Shock: Increase in Y_t

Suppose that there is an exogenous increase in current income, from $Y_{0,t}$ to $Y_{1,t}$. This results in the Y^s curve shifting out to the right. There is no shift of the IS curve since a change in Y_t does not affect autonomous expenditure. These effects are shown in Figure 11.6 below:

Figure 11.6: Supply Shock: Increase in Y_t

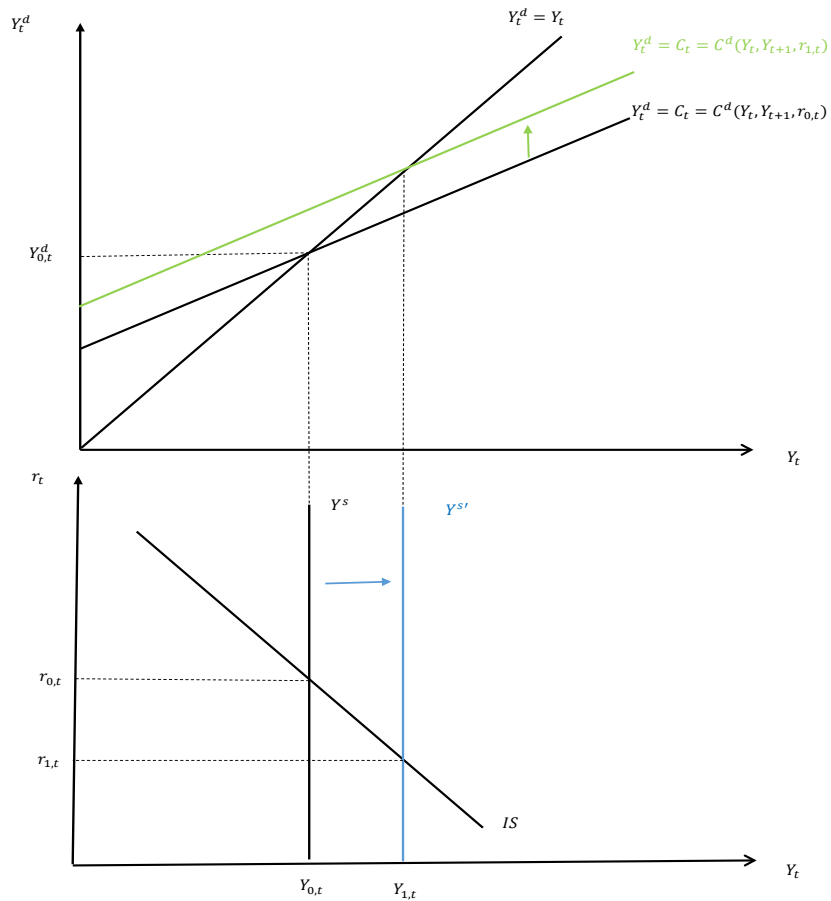

The rightward shift of the Y^s curve results in the real interest rate declining in equilibrium, to $r_{1,t}$. The lower real interest rate raises autonomous expenditure, so the expenditure line shifts up (shown in green) in such a way that income equals expenditure at the new level of Y_t . Intuitively, one can think about the change in the interest rate as working to “undo” the consumption smoothing which we highlighted in Chapter 9. When current income increases, the household (though there are many households, because they are all the same and we have normalized the total number to one, we can talk of there being one, representative household) would like to increase its current consumption but by less than the increase in current income. It would like to save what is leftover. But in equilibrium, this is impossible since there is no one who wants to borrow. Hence, the real interest rate must fall to dissuade the household from increasing its saving. The real interest rate has to fall sufficiently so that the household is behaving according to its consumption function, but where its consumption simply equals its income.

11.3.2 Demand Shock: Increase in Y_{t+1}

Next, suppose that agents anticipate an increase in future income, from $Y_{0,t+1}$ to $Y_{1,t+1}$. This affects the current demand for goods, not the current supply. As shown in Figure 11.3, a higher Y_{t+1} causes the IS curve to shift out to the right. This is shown in blue in Figure 11.7 below.

Figure 11.7: Demand Shock: Increase in Y_{t+1}

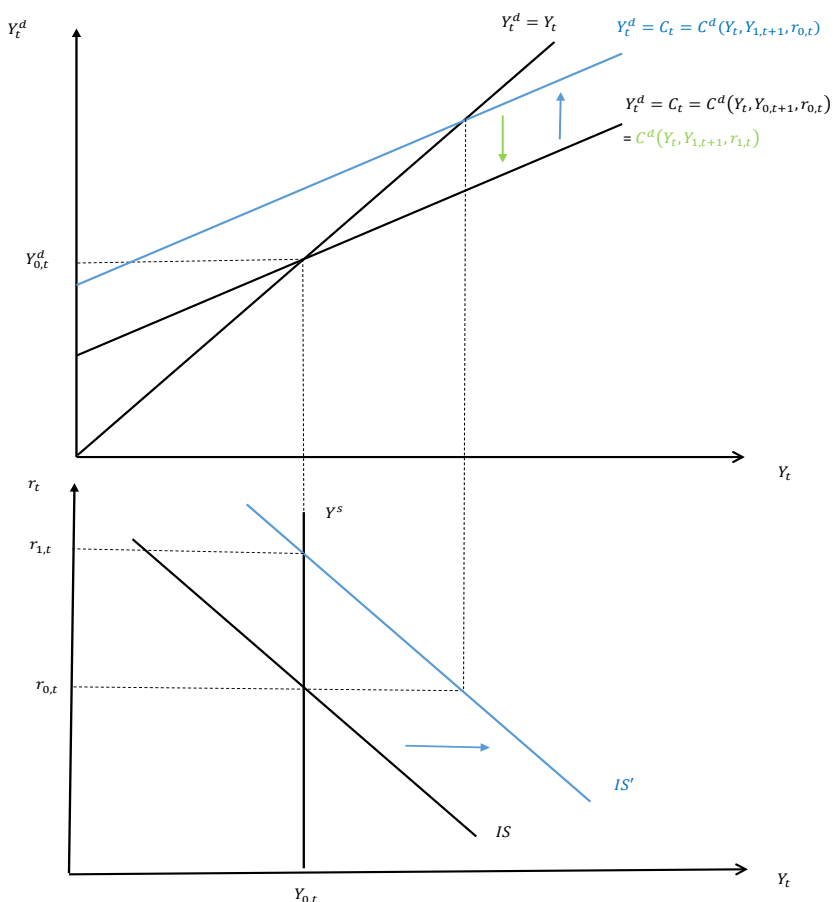

The rightward shift of the IS curve, combined with no shift in the Y^s curve, means that in equilibrium Y_t is unchanged while r_t rises. The higher r_t reduces autonomous expenditure back to its original level, so that the expenditure line shifts back down so as to intersect the 45 degree line at the fixed level of current income. Why does r_t rise when the household expects more future income? When future income is expected to increase, to smooth consumption the household would like to increase its current consumption by borrowing. But, in equilibrium, the household cannot increase its borrowing. Hence, r_t must rise so as to dissuade the

household from increasing its borrowing. In the new equilibrium, the consumption function must hold with the higher value of Y_{t+1} where C_t is unchanged. This necessitates an increase in r_t .

The exercises of examining how the real interest rate reacts to a change Y_t or a change in Y_{t+1} reveal a useful insight. In particular, in equilibrium the real interest rate is a measure of how plentiful the future is expected to be relative to the present. If Y_{t+1} is expected to rise relative to Y_t , then r_t rises. In contrast, if Y_t rises relative to Y_{t+1} , then r_t falls. As such, r_t is a measure of how plentiful the future is expected to be relative to the present. This is because r_t must adjust so as to undo the consumption smoothing that a household would like to do for a given r_t . While it is only true that $C_t = Y_t$ in equilibrium in an endowment economy, this insight will also carry over into a more complicated model with capital accumulation, saving, and investment.

Does the idea that the real interest rate conveys information about the plentifulness of the future relative to the present hold in the data? It does. In Figure 11.8, we show a scatter plot of the real interest rate (on the vertical axis) against a survey measure of expected real GDP growth in the US over the next ten years.¹ This is only based on twenty-five years of annual data but the relationship between the two series is clearly positive, with a correlation of about 0.3. The correlation is not as strong as might be predicted by our simple model, but the model is in fact too simple – the real world features a number of complicating factors, like capital accumulation and endogenous production. But nevertheless the simple insight that the equilibrium real interest rate tells you something about how good the future is expected to be relative to the present still seems to hold in the data.

¹The expected 10 year real GDP growth forecast is from the [Survey of Professional Forecasters](#). The real interest rate series is the 10 year Treasury interest rate less than the ten year expected CPI inflation rate, also from the [SPF](#).

Figure 11.8: Real Interest Rates and Expected Output Growth

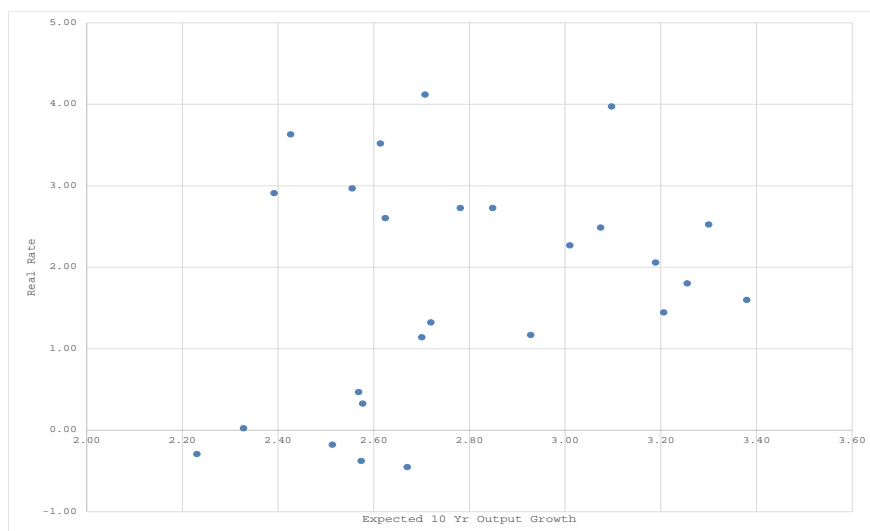

11.3.3 An Algebraic Example

Continue with the setup outlined in this section – agents are all identical and the total number of households is normalized to one. Suppose that the flow utility function is the natural log. This means that the Euler equation can be written:

$$\frac{C_{t+1}}{C_t} = \beta(1 + r_t) \quad (11.14)$$

The consumption function is:

$$C_t = \frac{1}{1 + \beta} Y_t + \frac{1}{1 + \beta} \frac{Y_{t+1}}{1 + r_t} \quad (11.15)$$

Total desired expenditure is:

$$Y_t^d = \frac{1}{1 + \beta} Y_t + \frac{1}{1 + \beta} \frac{Y_{t+1}}{1 + r_t} \quad (11.16)$$

Equating expenditure with income gives an expression for the IS curve:

$$Y_t = \frac{1}{\beta} \frac{Y_{t+1}}{1 + r_t} \quad (11.17)$$

(11.17) is a mathematical expression for the IS curve. It is decreasing in r_t and shifts out if Y_{t+1} increases. Given an exogenous amount of current output, the equilibrium real interest rate can then be solved for as:

$$1 + r_t = \frac{1}{\beta} \frac{Y_{t+1}}{Y_t} \quad (11.18)$$

In (11.18), we observe that the equilibrium real interest rate is simply proportional to the expected gross growth rate of output. This makes it very clear that the equilibrium real interest rate is a measure of how plentiful the future is expected to be relative to the present. Note that nothing prohibits the real interest rate from being negative – if Y_{t+1} is sufficiently small relative to Y_t , and β is sufficiently close to one, then we could have $r_t < 0$.

11.4 Agents with Different Endowments

Now, let us suppose that agents have identical preferences, but potentially have different endowments of income. Each type of agent has the Euler equation given by (11.5) and corresponding consumption function given by (11.6). The aggregate market-clearing condition is the same as in the setup where all households were identical.

For simplicity, suppose that there are two types of agents, 1 and 2. Households of the same type are identical. Assume that there are L_1 of type 1 agents, and L_2 of type 2 agents, with $L_1 + L_2 = L$ being the total number of households in the economy. Let's suppose that agents of type 1 receive income of $Y_t(1) = 1$ in the first period, but $Y_{t+1}(1) = 0$ in the second. Agents of type 2 have the reverse pattern: $Y_t(2) = 0$ and $Y_{t+1}(2) = 1$. Suppose that agents have log utility. This means that the generic consumption function for any agent of any type is given by:

$$C_t(j) = \frac{1}{1 + \beta} \left[Y_t(j) + \frac{Y_{t+1}(j)}{1 + r_t} \right] \quad \text{for } j = 1, 2 \quad (11.19)$$

Plugging in the specified endowment patterns for each type of agent yields the agent specific consumption functions:

$$C_t(1) = \frac{1}{1 + \beta} \quad (11.20)$$

$$C_t(2) = \frac{1}{1 + \beta} \frac{1}{1 + r_t} \quad (11.21)$$

The aggregate market-clearing condition is that aggregate consumption equals aggregate income, or $L_1 C_t(1) + L_2 C_t(2) = L_1$ (the aggregate endowment is L_1 because there are L_1 of type 1 agents who each receive one unit of the endowment). Plug in the consumption functions for each type of agent:

$$\frac{1}{1+\beta} \left[L_1 + \frac{L_2}{1+r_t} \right] = L_1 \quad (11.22)$$

Now, use this to solve for r_t :

$$1+r_t = \frac{1}{\beta} \frac{L_2}{L_1} \quad (11.23)$$

You will note that (11.23) is identical to (11.18) when all agents are identical, since $L_2 = Y_{t+1}$ (i.e. this is the aggregate level of future income) while $L_1 = Y_t$ (i.e. this is the aggregate level of current income). In other words, introducing income heterogeneity among households does not fundamentally alter the information conveyed by equilibrium real interest rate.

This setup is, however, more interesting in that there will be borrowing and saving going on at the micro level, even though in aggregate there is no borrowing or saving. We can plug in the expression for the equilibrium real interest rate into the consumption functions for each type, yielding:

$$C_t(1) = \frac{1}{1+\beta} \quad (11.24)$$

$$C_t(2) = \frac{\beta}{1+\beta} \frac{L_1}{L_2} \quad (11.25)$$

We can use this to see how much agents of each type borrow or save in equilibrium. The saving function for a generic household is $S_t(j) = Y_t(j) - C_t(j)$, or:

$$S_t(1) = 1 - \frac{1}{1+\beta} = \frac{\beta}{1+\beta} \quad (11.26)$$

$$S_t(2) = -\frac{\beta}{1+\beta} \frac{L_1}{L_2} \quad (11.27)$$

Here, we see that $S_t(1) > 0$ (households of type 1 save), while $S_t(2) < 0$ (households of type 2 borrow). It is straightforward to verify that aggregate saving is zero:

$$S_t = L_1 S_t(1) + L_2 S_t(2) \quad (11.28)$$

$$S_t = L_1 \frac{\beta}{1+\beta} - L_2 \frac{\beta}{1+\beta} \frac{L_1}{L_2} = 0 \quad (11.29)$$

In this setup, while aggregate saving is zero, individual saving and borrowing is not.

Agents of type 1 save, while agents of type 2 borrow. This makes sense – type 1 households have all their income in the first period, while type 2 agents have all their income in the second period. These households would like to smooth their consumption relative to their income – type 1 households are natural savers, while type 2 agents are natural borrowers. Since these agents are different, there is a mutually beneficial exchange available to them. These agents effectively engage in intertemporal trade, wherein type 1 households lend to type 2 households in the first period, and then type 2 households pay back some of their income to type 1 households in the second period. This mutually beneficial exchange arises from *differences* across agents. Nevertheless, these differences do not matter for the equilibrium value of r_t , which depends only on the aggregate endowment pattern.

Now let's change things up a bit. Continue to assume two types of agents with identical preferences. There are L_1 and L_2 of each type of agent, with $L = L_1 + L_2$ total agents. Let's change the endowment patterns a little bit. In particular, suppose that type 1 agents have $Y_t(1) = 0.75$ and $Y_{t+1}(1) = 0.25\frac{L_2}{L_1}$. The type 2 agents have $Y_t(2) = 0.25\frac{L_1}{L_2}$ and $Y_{t+1}(2) = 0.75$. Relative to the example worked out above, the aggregate endowments in each period here are the same:

$$Y_t = 0.75L_1 + 0.25L_2\frac{L_1}{L_2} = L_1 \quad (11.30)$$

$$Y_{t+1} = 0.25L_1\frac{L_2}{L_1} + 0.75L_2 = L_2 \quad (11.31)$$

Plug in these new endowment patterns to derive the consumption functions for each type of agent:

$$C_t(1) = \frac{0.75}{1 + \beta} + \frac{0.25\frac{L_2}{L_1}}{(1 + \beta)(1 + r_t)} \quad (11.32)$$

$$C_t(2) = \frac{0.25\frac{L_1}{L_2}}{1 + \beta} + \frac{0.75}{(1 + \beta)(1 + r_t)} \quad (11.33)$$

Aggregate consumption is:

$$C_t = L_1 C_t(1) + L_2 C_t(2) \quad (11.34)$$

$$C_t = \frac{0.75L_1}{1+\beta} + \frac{0.25L_2}{(1+\beta)(1+r_t)} + \frac{0.25L_1}{1+\beta} + \frac{0.75L_2}{(1+\beta)(1+r_t)} \quad (11.35)$$

$$C_t = \frac{L_1}{1+\beta} + \frac{L_2}{(1+\beta)(1+r_t)} \quad (11.36)$$

Now, equate aggregate consumption to the aggregate endowment (i.e. impose the market-clearing condition):

$$\frac{L_1}{1+\beta} + \frac{L_2}{(1+\beta)(1+r_t)} = L_1 \quad (11.37)$$

Now solve for r_t :

$$1+r_t = \frac{1}{\beta} \frac{L_2}{L_1} \quad (11.38)$$

Note that the expression for the equilibrium real interest rate here, (11.38), is *identical* to what we had earlier, (11.23). In particular, r_t depends only on the aggregate endowments across time, in both setups $Y_{t+1} = L_2$ and $Y_t = L_1$, not how those endowments are split across different types of households. Similarly, the aggregate level of consumption depends only on the aggregate endowments. We did this example with particular endowment patterns, but you can split up the endowment patterns however you like (so long as the aggregate endowments are the same) and you will keep getting the same expression for the equilibrium real interest rate.

These examples reveal a crucial point, a point which motivates the use of representative agents in macroeconomics. In particular, so long as agents can freely borrow and lend with one another (through a financial intermediary), the distribution of endowments is irrelevant for the equilibrium values of aggregate prices and quantities. It is often said that this is an example of *complete markets* – as long as agents can freely trade with one another, microeconomic distributions of income do not matter for the evolution of aggregate quantities and prices. Markets would not be complete if there were borrowing constraints, for example, because then agents could not freely trade with one another. In such a case, equilibrium quantities and prices would depend on the distribution of resources across agents.

11.5 Summary

- In this chapter the real interest rate is an endogenous object.

- Endogenizing prices and allocations requires an equilibrium concept. We use a competitive equilibrium which is defined as a set of prices and allocations such that all individuals optimize and markets clear.
- In equilibrium, some individuals can save and others can borrow, but in aggregate there is no saving.
- The IS curve is defined as the set of (r_t, Y_t) points where total desired expenditure equals income.
- The Y^s curve is defined as the set of all (r_t, Y_t) points such that individuals are behaving optimally and is consistent with the production technology of the economy. Since output is exogenously supplied in the endowment economy, the aggregate supply curve is a simple vertical line.
- An increase in the current endowment shifts the aggregate supply curve to the right and lowers the equilibrium real interest rate.
- An increase in the future endowment can be thought of as a “demand” shock. In this case the equilibrium real interest rate rises.
- Provided all individuals are free to borrow and lend, the aggregate real interest rate is invariant to the distribution of endowments.

Key Terms

- Market clearing
- Competitive equilibrium
- Desired aggregate expenditure
- Autonomous aggregate expenditure
- IS curve
- Y^s curve
- Complete markets

Questions for Review

1. Write down the equations for a competitive equilibrium in a representative agent economy and describe what each one represents.

2. How do changes in r_t provide information about the scarcity of resources today relative to tomorrow?
3. Graphically derive the IS curve.
4. Graphically depict the equilibrium in the IS - Y^s graph.
5. Show graphically the effect of an increase in Y_{t+1} on consumption and the interest rate. Clearly explain the intuition.
6. Under what circumstances does the distribution of endowments become irrelevant for determining aggregate quantities?

Exercises

1. **General Equilibrium in an Endowment Economy** Suppose the economy is populated by many identical agents. These agents act as price takers and take current and future income as given. They live for two periods: t and $t + 1$. They solve a standard consumption-savings problem which yields a consumption function

$$C_t = C(Y_t, Y_{t+1}, r_t).$$

- (a) What are the signs of the partial derivative of the consumption function? Explain the economic intuition.
- (b) Suppose there is an increase in Y_t holding Y_{t+1} and r_t fixed. How does the consumer want to adjust its consumption and saving? Explain the economic intuition.
- (c) Suppose there is an increase in Y_{t+1} holding Y_t and r_t fixed. How does the consumer want to adjust its consumption and saving? Explain the economic intuition.
- (d) Now let's go to equilibrium. What is the generic definition of a competitive equilibrium?
- (e) Define the IS curve and graphically derive it.
- (f) Graph the Y^s curve with the IS curve and show how you determine the real interest rate.
- (g) Suppose there is an increase in Y_t . Show how this affects the equilibrium real interest rate. Explain the economic intuition for this.
- (h) Now let's tell a story. Remember we are thinking about this one good as fruit. Let's say that meteorologists in period t anticipate a hurricane

in $t + 1$ that will wipe out most of the fruit in $t + 1$. How is this forecast going to be reflected in r_t ? Show this in your $IS - Y^s$ graph and explain the economic intuition.

- (i) Generalizing your answer from the last question, what might the equilibrium interest rate tell you about the expectations of Y_{t+1} relative to Y_t ?

2. **Equilibrium with linear utility:** Suppose that there exist many identical households in an economy. The representative household has the following lifetime utility function:

$$U = C_t + \beta C_{t+1}$$

It faces a sequence of period budget constraints which can be combined into one intertemporal budget constraint:

$$C_t + \frac{C_{t+1}}{1 + r_t} = Y_t + \frac{Y_{t+1}}{1 + r_t}$$

The endowment, Y_t and Y_{t+1} , is exogenous, and the household takes the real interest rate as given.

- (a) Derive the consumption function for the representative household (note that it will be piecewise).
- (b) Derive a saving function for this household, where saving is defined as $S_t = Y_t - C_t$ (plug in your consumption function and simplify).
- (c) Solve for expressions for the equilibrium values of r_t .
- (d) How does r_t react to changes in Y_t and Y_{t+1} . What is the economic intuition for this?
- (e) If j indexes the people in this economy, does $S_{j,t}$ have to equal 0 for all j ? How is this different from the more standard case?
3. **The Yield Curve** Suppose you have an economy with one type of agent, but that time lasts for three periods instead of two. Lifetime utility for the household is:

$$U = \ln C_t + \beta \ln C_{t+1} + \beta^2 \ln C_{t+2}$$

The intertemporal budget constraint is:

$$C_t + \frac{C_{t+1}}{1+r_t} + \frac{C_{t+2}}{(1+r_t)(1+r_{t+1})} = Y_t + \frac{Y_{t+1}}{1+r_t} + \frac{Y_{t+2}}{(1+r_t)(1+r_{t+1})}$$

r_t is the interest rate on saving / borrowing between t and $t+1$, while r_{t+1} is the interest rate on saving / borrowing between $t+1$ and $t+2$.

- (a) Solve for C_{t+2} in the intertemporal budget constraint, and plug this into lifetime utility. This transforms the problem into one of choosing C_t and C_{t+1} . Use calculus to derive two Euler equations – one relating C_t to C_{t+1} , and the other relating C_{t+1} to C_{t+2} .
- (b) In equilibrium, we must have $C_t = Y_t$, $C_{t+1} = Y_{t+1}$, and $C_{t+2} = Y_{t+2}$. Derive expressions for r_t and r_{t+1} in terms of the exogenous endowment path and β .
- (c) One could define the “long” interest rate as the product of one period interest rates. In particular, define $(1+r_{2,t})^2 = (1+r_t)(1+r_{t+1})$ (the squared term on $1+r_{2,t}$ reflects the fact that if you save for two periods you get some compounding). If there were a savings vehicle with a two period maturity, this condition would have to be satisfied (intuitively, because a household would be indifferent between saving twice in one period bonds or once in a two period bond). Derive an expression for $r_{2,t}$.
- (d) The yield curve plots interest rates as a function of time maturity. In this simple problem, one would plot r_t against 1 (there is a one period maturity) and $r_{2,t}$ against 2 (there is a two period maturity). If $Y_t = Y_{t+1} = Y_{t+2}$, what is the sign of slope of the yield curve (i.e. if $r_{2,t} > r_{1,t}$, then the yield curve is upward-sloping).
- (e) It is often claimed that an “[inverted yield curve](#)” is a predictor of a recession. If Y_{t+2} is sufficiently low relative to Y_t and Y_{t+1} , could the yield curve in this simple model be “inverted” (i.e. opposite sign) from what you found in the above part? Explain.

4. **Heterogeneity in an endowment economy** Suppose we have two types of households: A and B. The utility maximization problem for a consumer of type i is

$$\max_{C_t, C_{t+1}} \ln C_{i,t} + \beta \ln C_{i,t+1}$$

subject to

$$C_{i,t} + \frac{C_{i,t+1}}{1+r_t} = Y_{i,t} + \frac{Y_{i,t+1}}{1+r_t}$$

Note that the A and B households have the same discount rate and the same utility function. The only thing that is possibly different is their endowments.

- (a) Write down the Euler equation for households A and B.
- (b) Solve for the time t and $t + 1$ consumption functions for households A and B.
- (c) Suppose $(Y_{A,t}, Y_{A,t+1}) = (1, 2)$ and $(Y_{B,t}, Y_{B,t+1}) = (2, 1)$. Solve for the equilibrium interest rate.
- (d) Substitute this market clearing interest rate back into your consumption functions for type A and B households and solve for the equilibrium allocations. Which household is borrowing in the first period and which household is saving? What is the economic intuition for this?
- (e) Describe why borrowing and savings occur in this economy, but not the representative household economy. Why does household B have higher consumption in each period?
- (f) Assuming $\beta = 0.9$ compare the lifetime utility of each type of household when they consume their endowment versus when they consume their equilibrium allocation. That is calculate household A's utility when it consumes its endowment and compare it to when household A consumes its equilibrium allocation. Which utility is higher? Do the same thing for household B. What is the economic intuition for this result?

Chapter 12

Production, Labor Demand, Investment, and Labor Supply

In this chapter, we analyze the microeconomic underpinnings of the firm problem. In particular, we derive expressions for labor and investment demand. We also augment the household side of the model to include an endogenous labor choice. The work done in this chapter serves as the backbone of the neoclassical and Keynesian models to come.

12.1 Firm

We assume that there exists a representative firm. This representative firm produces output, Y_t , using capital, K_t , and labor, N_t , as inputs. There is an exogenous productivity term, A_t , which the firm takes as given. Inputs are turned into outputs via:

$$Y_t = A_t F(K_t, N_t) \tag{12.1}$$

This is the same production assumed throughout Part II. We do not model growth in labor augmenting technology. In the terminology of Chapter 6, one can think about fixing $Z_t = 1$. Somewhat differently than in the chapters studying the long run, we are going to keep the time subscript on A_t . We want to entertain the consequences of both *transitory* changes in productivity (i.e. A_t changes but A_{t+1} does not) as well as *anticipated* changes in productivity (i.e. A_{t+1} changes, and agents are aware of this in period t , but A_t is unaffected).

The production function has the same properties as assumed earlier. It is increasing in both arguments – $F_K > 0$ and $F_N > 0$, so that the marginal products of capital and labor are both positive. It is concave in both arguments – $F_{KK} < 0$ and $F_{NN} < 0$, so that there are diminishing marginal products of capital and labor. The cross-partial derivative between capital and labor is positive, $F_{KN} > 0$. This means that more capital raises the marginal product of labor (and vice-versa). We also assume that both inputs are necessary to produce anything, so $F(0, N_t) = F(K_t, 0) = 0$. Finally, we assume that the production function has constant returns to scale. This means $F(\gamma K_t, \gamma N_t) = \gamma F(K_t, N_t)$. In words, this means that if you double both capital and labor, you double output. The Cobb-Douglas production

function is a popular functional form satisfying these assumptions:

$$F(K_t, N_t) = K_t^\alpha N_t^{1-\alpha}, \quad 0 < \alpha < 1 \quad (12.2)$$

Figure 12.1 plots a hypothetical production function. In particular, we plot Y_t as a function of N_t , holding K_t and A_t fixed. The plot starts in the origin (labor is necessary to produce output), and is increasing, but at a decreasing rate. If either A_t or K_t were to increase, the production function would shift up (it would also become steeper at each value of N_t). This is shown with the hypothetical blue production function in the graph.

Figure 12.1: The Production Function

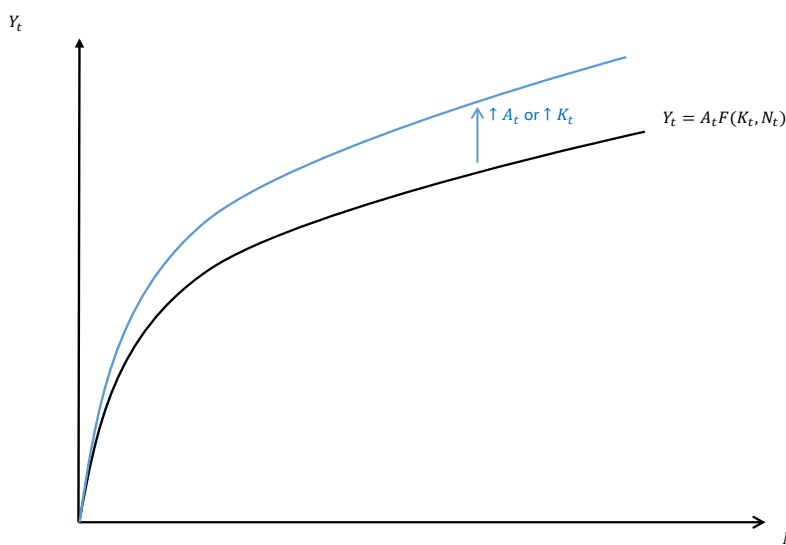

There is a representative household who owns the representative firm, but management is separated from ownership (i.e. the household and firm are separate decision-making entities). Both the household and firm live for two periods – period t (the present) and period $t + 1$ (the future). The firm is endowed with some existing capital, K_t , and hires labor, N_t , at real wage rate, w_t . Capital is predetermined (and hence exogenous) in period t – the only variable factor of production for the firm in period t is labor. Investment constitutes expenditure by the firm on new capital which will be available for production in the future. The capital accumulation equation is the same as in the Solow model in Chapter 5:

$$K_{t+1} = I_t + (1 - \delta)K_t \quad (12.3)$$

We assume that the firm must borrow funds from a financial intermediary to fund investment. The cost of borrowing is r_t , which is the same interest rate faced by the

household.¹ Let B_t^I denote borrowing by the firm to finance its investment. We assume that $B_t^I = I_t$, so that all of investment expenditure must be financed by borrowing.

In period t , the firm's profit is the difference between its revenue (equal to its output, Y_t) and its payments to labor, $w_t N_t$. This profit is returned to the household as a dividend, D_t :

$$D_t = Y_t - w_t N_t \quad (12.4)$$

In period $t + 1$, the firm faces the same capital accumulation equation (12.3), but will not want to leave any capital over for period $t + 2$ (since the firm ceases to exist after period $t + 1$). Since the firm desires $K_{t+2} = 0$, this implies that $I_{t+1} = -(1 - \delta)K_{t+1}$. This is analogous to the household not wanting to die with a positive stock of savings. In other words, in period $t + 1$ the firm does negative investment, which amounts to selling off its remaining capital in a sort of "liquidation sale." After production in $t + 1$ takes place, there are $(1 - \delta)K_{t+1}$ units of capital remaining (some of the capital brought into $t + 1$ is lost due to depreciation). This is sold off and is a component of firm revenue in period $t + 1$. Firm expenses in $t + 1$ include the labor bill, $w_{t+1}N_{t+1}$, as well as paying off the interest and principal on the loan taken out in period t to finance investment, $(1 + r_t)B_t^I$. The dividend returned to the household in $t + 1$ is then:

$$D_{t+1} = Y_{t+1} + (1 - \delta)K_{t+1} - w_{t+1}N_{t+1} - (1 + r_t)B_t^I \quad (12.5)$$

The value of the firm is the present discounted value of dividends:

$$V_t = D_t + \frac{1}{1 + r_t} D_{t+1} \quad (12.6)$$

Future dividends are discounted by $\frac{1}{1+r_t}$, where r_t is the interest rate relevant for household saving/borrowing decisions. Why is this the value of the firm? Ownership in the firm is a claim to its dividends. The amount of goods that a household would be willing to give up to purchase the firm is equal to the present discounted value of its dividends, where the present discounted value is calculated using the interest rate relevant to the household.

If we plug in the production function as well as the expressions for period t and $t + 1$ dividends, the value of the firm can be written:

¹In a previous edition of the book we introduced an exogenous credit spread into the model at this point, with $r_t^I = r_t + f_t$, where f_t is an exogenous spread and can be interpreted as a return to financial intermediation. We now omit the credit spread here but return it later in the book when discussing financial crises.

$$V_t = A_t F(K_t, N_t) - w_t N_t + \frac{1}{1+r_t} [A_{t+1} F(K_{t+1}, N_{t+1}) + (1-\delta)K_{t+1} - w_{t+1}N_{t+1} - (1+r_t)B_t^I] \quad (12.7)$$

From the perspective of period t , the firm's objective is to choose its labor input, N_t , and investment, I_t , to maximize its value, (12.7). This maximization problem is subject to two constraints – the capital accumulation restriction, (12.3), and the requirement that investment be financed by borrowing, $I_t = B_t^I$. The firm's constrained optimization problem can therefore be written:

$$\max_{N_t, I_t} V_t = A_t F(K_t, N_t) - w_t N_t + \frac{1}{1+r_t} [A_{t+1} F(K_{t+1}, N_{t+1}) + (1-\delta)K_{t+1} - w_{t+1}N_{t+1} - (1+r_t)B_t^I] \quad (12.8)$$

s.t.

$$K_{t+1} = I_t + (1-\delta)K_t \quad (12.9)$$

$$I_t = B_t^I \quad (12.10)$$

If we combine the two constraints with one another, we can write:

$$B_t^I = K_{t+1} - (1-\delta)K_t \quad (12.11)$$

Substituting (12.11) in to eliminate B_t^I , we can then re-write the optimization problem, (12.8), as an unconstrained problem of choosing N_t and K_{t+1} :

$$\max_{N_t, K_{t+1}} V_t = A_t F(K_t, N_t) - w_t N_t + \frac{1}{1+r_t} [A_{t+1} F(K_{t+1}, N_{t+1}) + (1-\delta)K_{t+1} - w_{t+1}N_{t+1} - (1+r_t)(K_{t+1} - (1-\delta)K_t)] \quad (12.12)$$

To find the value-maximizing levels of N_t and K_{t+1} , take the partial derivatives of V_t with respect to each:

$$\frac{\partial V_t}{\partial N_t} = A_t F_N(K_t, N_t) - w_t \quad (12.13)$$

$$\frac{\partial V_t}{\partial K_{t+1}} = \frac{1}{1+r_t} [A_{t+1}F_K(K_{t+1}, N_{t+1}) + (1-\delta) - (1+r_t)] \quad (12.14)$$

Setting these partial derivatives equal to zero and simplifying yields:

$$w_t = A_t F_N(K_t, N_t) \quad (12.15)$$

$$1+r_t = A_{t+1}F_K(K_{t+1}, N_{t+1}) + (1-\delta) \quad (12.16)$$

Expression (12.15) implicitly defines a demand for labor.² In particular, a firm wants to hire labor up until the point at which the marginal product of labor, $F_N(K_t, N_t)$, equals the real wage. The intuition for this condition is simply that the firm wants to hire labor up until the point at which marginal benefit equals marginal cost. The marginal benefit of an additional unit of labor is the marginal product of labor. The marginal cost of an additional unit of labor is the real wage. At an optimum, marginal benefit and cost must be equal. If $w_t > F_N(K_t, N_t)$, the firm could increase its value by hiring less labor; if $w_t < F_N(K_t, N_t)$, the firm could increase its value by hiring more labor.

Figure 12.2 plots a hypothetical labor demand function. Since $F_{NN} < 0$, the marginal product of labor is decreasing in N_t . Hence, the labor demand curve slopes down. It could be curved or a straight line depending on the nature of the production function; for simplicity we have here drawn it is a straight line. Labor demand will increase if either A_t or K_t increase. For a given wage, if A_t is higher, the firm needs a higher level of N_t for the wage to equal the marginal product. Similarly, since we assume that $F_{KN} > 0$, if K_t were higher, the firm would need more N_t for a given w_t to equate the marginal product of labor with the wage.

²Note that one could also find a first order condition with respect to future labor, N_{t+1} , and would arrive at the same first order condition, only dated $t+1$ instead of t .

Figure 12.2: Labor Demand

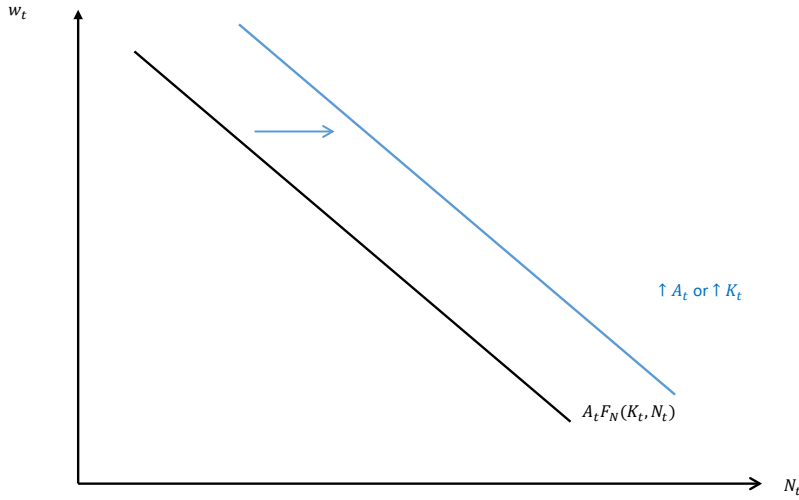

(12.15) implicitly defines the optimal N_t as a function of A_t and K_t . We will use the following to qualitatively denote the labor demand function:

$$N_t = N^d(w_t, \underset{-}{A_t}, \underset{+}{K_t}) \quad (12.17)$$

Labor demand is a function of the wage, productivity, and capital. The + and - signs denote the qualitative signs of the partial derivatives. Labor demand is decreasing in the real wage, increasing in A_t , and increasing in the capital stock.

Next, let us focus on the first order condition for the choice of K_{t+1} , (12.16). First, what is intuition for why this condition must hold? Suppose that the firm wants to do one additional unit of investment in period t . The marginal cost of doing an additional unit of investment is the interest plus principal that will be owed to the financial intermediary in period $t + 1$, $1 + r_t$. This represents the marginal cost of investment and it is not borne until period $t + 1$. What is the marginal benefit of doing additional investment in period t ? One additional unit of investment in period t generates one additional unit of capital in period $t + 1$. This raises future revenue by the marginal product of future capital, $A_{t+1}F_K(K_{t+1}, N_{t+1})$. In addition, more investment in t generates some additional liquidation of future capital of amount $(1 - \delta)$. Hence, $A_{t+1}F_K(K_{t+1}, N_{t+1}) + (1 - \delta)$ represents the marginal benefit of an additional unit of investment in period t . (12.16) simply says to invest up until the point at which the marginal benefit of investment equals the marginal cost. The marginal benefit and marginal cost are both received in the future, and hence the optimality condition needs no discounting.

We can re-write (12.16) as:

$$r_t + \delta = A_{t+1}F_K(K_{t+1}, N_{t+1}) \quad (12.18)$$

Let us now focus on (12.18) and walk through how changes in things which the firm takes as given will affect its optimal choice of K_{t+1} . Suppose that r_t increases. This makes the left hand side larger. For (12.18) to hold, the firm must adjust K_{t+1} in such a way to make the marginal product of future capital go up. Suppose that the firm anticipates an increase in future productivity, A_{t+1} . Since there would be no change in the left hand side, the firm would need to adjust K_{t+1} to keep the marginal product of future capital fixed. This requires increasing K_{t+1} . From these exercises, we can deduce that the period t demand for future capital is a function of the sort:

$$K_{t+1} = K^d(r_t, A_{t+1}) \quad (12.19)$$

In other words, the demand for future capital is decreasing in the real interest rate and increasing in future productivity. Importantly, relative to labor demand, capital demand is forward-looking – it depends not on current productivity, but rather future productivity.

Now, let us use (12.19) to think about the demand for investment. We can do this by combining (12.19) with the capital accumulation equation, (12.3). Taking K_t as given, if the firm wants more K_{t+1} , it needs to do more I_t . Hence, we can deduce that the demand for investment is decreasing in the real interest rate and increasing in the future level of productivity. We can also think about how the firm's exogenously given current level of capital, K_t , influences its desired investment. The current level of capital does not influence the desired future level of capital, which can be seen clearly in (12.18). But if K_t is relatively high, then the firm needs to do relatively little I_t to hit a given target level of K_{t+1} . Hence, the demand for investment ought to be decreasing in the current level of capital, K_t . Hence, we can deduce that investment demand is qualitatively characterized by:

$$I_t = I^d(r_t, A_{t+1}, K_t) \quad (12.20)$$

Figure 12.3 plots a hypothetical investment demand function. We have drawn it as a line for simplicity, but in principle this investment demand function would have some curvature. Investment demand is decreasing in the real interest rate, so the curve slopes down. It would shift out to the right if A_{t+1} increased, or if f_t or K_t decreased.

Figure 12.3: Investment Demand

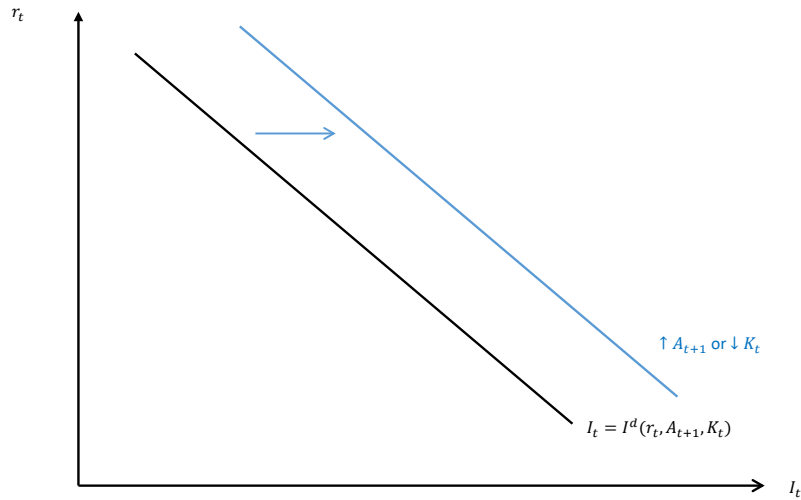

Expressions (12.1), (12.17), and (12.20) qualitatively summarize the solution to the firm problem.

12.1.1 Diversion on Debt vs. Equity Finance

In the setup currently employed, we have assumed that the firm finances its accumulation of capital via debt. By this, we mean that the firm finances purchases of new capital by borrowing from a financial intermediary. Bank loans constitute a substantial fraction of firm investment outlays in the US and other developed countries, particularly so for medium and small sized firms. An alternative assumption we could make is that the firm finances its purchases of new capital via equity. By equity we mean that the firm purchases new capital by reducing its current dividend, which is equivalent to issuing new shares of stock. In the setup we have described, it turns out that there is no difference between debt and equity finance – the resulting optimality conditions will be identical. This is a statement of the Modigliani-Miller theorem in economics/finance – see [Modigliani and Miller \(1958\)](#). Basically, the theorem states that under certain conditions, how the firm finances its investment is irrelevant, which is exactly what we see here. The theorem only holds in special cases and is unlikely to fully characterize reality. In particular, the theory assumes no taxes, no bankruptcy cost, and no asymmetric information between borrowers and lenders, none of which are likely hold in the real world. By focusing on the setup in which firms must borrow to finance investment, we are laying the groundwork for a later extension where we introduce time-varying credit spreads. Credit spreads can be interpreted as returns to

financial intermediation and emerge because of things like asymmetric information, to be discussed later.

Let $q \in [0, 1]$ denote the fraction of the firm's period t investment that is financed via equity, while $1 - q$ is the fraction of investment financed by debt. If a firm wants to raise one unit of new capital via equity, it reduces its period t dividend by this amount. Hence, the period t and $t + 1$ dividends for the firm are:

$$D_t = A_t F(K_t, N_t) - w_t N_t - q I_t \quad (12.21)$$

$$D_{t+1} = A_{t+1} F(K_{t+1}, N_{t+1}) + (1 - \delta) K_{t+1} - w_{t+1} N_{t+1} - (1 + r_t)(1 - q) I_t \quad (12.22)$$

In (12.21), the firm spends $q I_t$ to purchase new capital, which reduces the dividend payout. The firm borrows $B_t^I = (1 - q) I_t$. Hence it faces an expense of interest plus principal of $(1 + r_t)(1 - q) I_t$ in $t + 1$, which is reflected in (12.22). By re-writing the problem as one of choosing K_{t+1} instead of I_t from the capital accumulation equation, we can express the firm's optimization problem as an unconstrained maximization problem as before:

$$\begin{aligned} \max_{N_t, K_{t+1}} \quad & V_t = A_t F(K_t, N_t) - w_t N_t - q(K_{t+1} - (1 - \delta)K_t) + \\ & \frac{A_{t+1} F(K_{t+1}, N_{t+1}) + (1 - \delta)K_{t+1} - w_{t+1} N_{t+1} - (1 + r_t)(1 - q)(K_{t+1} - (1 - \delta)K_t)}{1 + r_t} \end{aligned} \quad (12.23)$$

Take the partial derivatives with respect to the remaining choice variables:

$$\frac{\partial V_t}{\partial N_t} = A_t F_N(K_t, N_t) - w_t \quad (12.24)$$

$$\frac{\partial V_t}{\partial K_{t+1}} = -q + \frac{1}{1 + r_t} [A_{t+1} F_K(K_{t+1}, N_{t+1}) + (1 - \delta) - (1 + r_t)(1 - q)] \quad (12.25)$$

Setting these derivatives equal to zero yields:

$$A_t F_N(K_t, N_t) = w_t \quad (12.26)$$

$$(1 + r_t)q + (1 + r_t)(1 - q) = A_{t+1} F_K(K_{t+1}, N_{t+1}) + (1 - \delta) \quad (12.27)$$

(12.26) is identical to (12.15). The left hand side of (12.27) reduces to $1 + r_t$ regardless of the value of q . This is the same as the optimality condition derived above, (12.16). This is

the Modigliani-Miller theorem in action – *it does not matter whether the firm finances itself via debt or equity; the implied investment demand function is the same.*

12.2 Household

Let us now think about the household problem. In many ways, this is identical to the setup from Chapter 9, with the main exception that we now endogenize the choice of labor supply.

Generically, let household flow utility now be a function of both consumption, C_t , as well as leisure, $L_t = 1 - N_t$. Here, we normalize the total endowment of time to 1; N_t denotes time spent working, so $1 - N_t$ is leisure time. Denote this utility function by $u(C_t, 1 - N_t)$. We assume that $u_C > 0$ and $u_{CC} < 0$. This means that the marginal utility of consumption is positive, but decreases as consumption gets higher. In addition, we assume that $U_L > 0$ and $U_{LL} < 0$, where U_L is the derivative with respect to the second argument, leisure. This means that more leisure increases utility, but at a diminishing rate. In other words, one can just think of leisure as another “good.” Since utility is increasing in leisure, and leisure is decreasing in labor, utility is decreasing in labor. Lifetime utility is the weighted sum of flow utility from periods t and $t + 1$, where period $t + 1$ flow utility gets discounted by $0 < \beta < 1$:

$$U = u(C_t, 1 - N_t) + \beta u(C_{t+1}, 1 - N_{t+1}) \quad (12.28)$$

Example

Let’s consider a couple of different potential specifications for the flow utility function. First, suppose that utility is given by:

$$u(C_t, 1 - N_t) = \ln C_t + \theta_t \ln(1 - N_t) \quad (12.29)$$

In (12.29), we say that utility is “additively separable” in consumption and leisure. Technically, this means that $U_{CL} = 0$ – i.e. the level of leisure (or labor) has no influence on the marginal utility of consumption, and vice versa. θ_t is an exogenous variable which we will refer to as a preference shock. An increase in θ_t means that the household values leisure more relative to consumption. For this utility function, utility is increasing and concave in both consumption and leisure. The partial derivatives of this utility function are:

$$u_C = \frac{1}{C_t} > 0 \quad (12.30)$$

$$u_L = \theta_t \frac{1}{1 - N_t} > 0 \quad (12.31)$$

$$u_{CC} = -\frac{1}{C_t^2} < 0 \quad (12.32)$$

$$u_{LL} = -\theta_t \frac{1}{(1 - N_t)^2} < 0 \quad (12.33)$$

$$u_{CL} = 0 \quad (12.34)$$

Next, consider another utility function that is not additively separable. In particular, suppose:

$$u(C_t, 1 - N_t) = \ln(C_t + \theta_t \ln(1 - N_t)) \quad (12.35)$$

Here, we need to assume that θ_t is such that $C_t + \theta_t \ln(1 - N_t)$ is always positive, so that the log of this term is always defined. Here, utility is non-separable in consumption and leisure in that the cross-partial derivative will not be zero. We can see this below:

$$u_C = \frac{1}{C_t + \theta_t \ln(1 - N_t)} > 0 \quad (12.36)$$

$$u_L = \frac{\theta_t}{1 - N_t} \frac{1}{C_t + \theta_t \ln(1 - N_t)} > 0 \quad (12.37)$$

$$u_{CC} = -\frac{1}{(C_t + \theta_t \ln(1 - N_t))^2} < 0 \quad (12.38)$$

$$u_{LL} = -\theta_t \frac{1}{(1 - N_t)^2} \frac{1}{C_t + \theta_t \ln(1 - N_t)} \left[\frac{\theta_t}{C_t + \theta_t \ln(1 - N_t)} + 1 \right] < 0 \quad (12.39)$$

$$u_{CL} = -\frac{\theta_t}{1 - N_t} \frac{1}{(C_t + \theta_t \ln(1 - N_t))^2} < 0 \quad (12.40)$$

With the flow utility function given by (12.35), we see that consumption and leisure are utility substitutes in the sense that $u_{CL} < 0$. In other words, this means that, when leisure is high (so labor is low), the marginal utility of consumption is relatively low. Conversely, when leisure is low (so labor is high), the marginal utility of consumption is high. Put another way, labor and consumption are utility

complements. Intuitively, if you're working a lot, the marginal utility of a beer (more consumption) is higher than if you're not working very much.

As before, the household begins life with no stock of wealth (for simplicity). It faces a sequence of two flow budget constraints. The only complication relative to Chapter 9 is that income is now endogenous rather than exogenous, since the household can decide how much it wants to work. The two flow budget constraints are:

$$C_t + S_t \leq w_t N_t + D_t \quad (12.41)$$

$$C_{t+1} + S_{t+1} \leq w_{t+1} N_{t+1} + D_{t+1} + D_{t+1}^I + (1 + r_t) S_t \quad (12.42)$$

In (12.41) the household earns income from two sources – labor income, $w_t N_t$, and dividend income from its ownership of the firm, D_t . In (12.42), the household has four distinct sources of income – labor income and dividend income as in period t , but also interest plus principal from savings brought from t to $t+1$, $(1 + r_t) S_t$, as well as a dividend payout from the financial intermediary. We label this dividend payout as D_{t+1}^I and discuss it further below. The financial intermediary earns nothing in period t , and hence there is no dividend from the intermediary in (12.41). As before, the household will not want to die with a positive stock of savings, and the financial intermediary will not allow the household to die in debt. Hence, $S_{t+1} = 0$. Imposing that each flow budget constraint hold with equality, one can derive an intertemporal budget constraint:

$$C_t + \frac{C_{t+1}}{1 + r_t} = w_t N_t + D_t + \frac{w_{t+1} N_{t+1} + D_{t+1} + D_{t+1}^I}{1 + r_t} \quad (12.43)$$

(12.43) has the same meaning as the intertemporal budget constraint encountered earlier – the present discounted value of the stream of consumption must equal the present discounted value of the stream of income. The income side is just a bit more complicated. Note that the household takes D_t , D_{t+1} , and D_{t+1}^I as given – it technically owns the firm and the financial intermediary, but ownership is distinct from management. The household's objective is to pick C_t , C_{t+1} , N_t , and N_{t+1} to maximize lifetime utility, (12.28), subject to the intertemporal budget constraint, (12.43):

$$\max_{C_t, C_{t+1}, N_t, N_{t+1}} U = u(C_t, 1 - N_t) + \beta u(C_{t+1}, 1 - N_{t+1}) \quad (12.44)$$

s. t.

$$C_t + \frac{C_{t+1}}{1 + r_t} = w_t N_t + D_t + \frac{w_{t+1} N_{t+1} + D_{t+1} + D_{t+1}^I}{1 + r_t} \quad (12.45)$$

We can handle this optimization problem by solving for one of the choice variables in terms of the others from the budget constraint. Let's solve for C_{t+1} :

$$C_{t+1} = (1 + r_t) [w_t N_t + D_t - C_t] + w_{t+1} N_{t+1} + D_{t+1} + D_{t+1}^I \quad (12.46)$$

Now, plug (12.46) into (12.44), which transforms this into an unconstrained optimization problem:

$$\max_{C_t, N_t, N_{t+1}} U = u(C_t, 1 - N_t) + \beta u((1 + r_t) [w_t N_t + D_t - C_t] + w_{t+1} N_{t+1} + D_{t+1} + D_{t+1}^I, 1 - N_{t+1}) \quad (12.47)$$

Now, find the partial derivatives with respect to the variables the household gets to choose:

$$\frac{\partial U}{\partial C_t} = u_C(C_t, 1 - N_t) - (1 + r_t) \beta u_C(C_{t+1}, 1 - N_{t+1}) \quad (12.48)$$

$$\frac{\partial U}{\partial N_t} = -u_L(C_t, 1 - N_t) + \beta(1 + r_t) w_t u_C(C_{t+1}, 1 - N_{t+1}) \quad (12.49)$$

$$\frac{\partial U}{\partial N_{t+1}} = -\beta u_L(C_{t+1}, 1 - N_{t+1}) + \beta w_{t+1} u_C(C_{t+1}, 1 - N_{t+1}) \quad (12.50)$$

In writing these derivatives, we have taken the liberty of noting that the argument in the flow utility function for period $t + 1$ is in fact C_{t+1} . Setting these derivatives equal to zero yields:

$$u_C(C_t, 1 - N_t) = \beta(1 + r_t) u_C(C_{t+1}, 1 - N_{t+1}) \quad (12.51)$$

$$u_L(C_t, 1 - N_t) = \beta(1 + r_t) w_t u_C(C_{t+1}, 1 - N_{t+1}) \quad (12.52)$$

$$u_L(C_{t+1}, 1 - N_{t+1}) = w_{t+1} u_C(C_{t+1}, 1 - N_{t+1}) \quad (12.53)$$

If one combines (12.51) with (12.52), (12.52) can be written in a way that looks identical to (12.53), only dated period t instead of period $t + 1$:

$$u_L(C_t, 1 - N_t) = w_t u_C(C_t, 1 - N_t) \quad (12.54)$$

Let us now stop to take stock of these optimality conditions and develop some intuition for why they must hold. First, note that (12.51) is the same Euler equation as we had in the two period model where income was taken to be exogenous. The marginal utility of current consumption ought to equal $1 + r_t$ times the marginal utility of future consumption. It only

looks more complicated in that the marginal utility of consumption could depend on the level of leisure (equivalently the amount of labor supplied). If the household decides to consume one additional unit of goods in period t , then the marginal benefit is $u_C(C_t, 1 - N_t)$ – i.e. this is by how much lifetime utility goes up. The cost of consuming an additional unit of goods in period t is saving one fewer unit, which leaves the household with $1 + r_t$ fewer units of available resources in the next period. This reduces lifetime utility by $\beta u_C(C_{t+1}, 1 - N_{t+1})(1 + r_t) - \beta u_C(C_{t+1}, 1 - N_{t+1})$ is the marginal utility of $t + 1$ consumption, while $1 + r_t$ is the drop in $t + 1$ consumption. At an optimum, the marginal benefit of consuming more must equal the marginal cost of doing so.

Next, turn to the first order conditions for labor supply. Suppose that the household takes an additional unit of leisure (i.e. works a little less). The marginal benefit of this is the marginal utility of leisure, $u_L(C_t, 1 - N_t)$. What is the marginal cost? Taking more leisure means working less, which means foregoing w_t units of income. This reduces available consumption by w_t units, which lowers utility by this times the marginal utility of consumption. Hence, $w_t u_C(C_t, 1 - N_t)$ is the marginal utility cost of additional leisure. At an optimum, the marginal utility benefit of leisure must equal the marginal utility cost. The first order condition for N_{t+1} looks exactly the same (and has the same interpretation) as the period t optimality condition. This is analogous to the firm's first order conditions for N_t and N_{t+1} – these conditions are static in the sense of only depending on current period values of variables.

Example

Consider the two flow utility functions described in the above example. For the separable case, the first order conditions work out to:

$$\frac{1}{C_t} = \beta(1 + r_t) \frac{1}{C_{t+1}} \quad (12.55)$$

$$\theta_t \frac{1}{1 - N_t} = w_t \frac{1}{C_t} \quad (12.56)$$

$$\theta_t \frac{1}{1 - N_{t+1}} = w_{t+1} \frac{1}{C_{t+1}} \quad (12.57)$$

Next, consider the non-separable utility specification. The first order conditions work out to:

$$\frac{1}{C_t + \theta_t \ln(1 - N_t)} = \beta(1 + r_t) \frac{1}{C_{t+1} + \theta_t \ln(1 - N_{t+1})} \quad (12.58)$$

$$\theta_t \frac{1}{1 - N_t} = w_t \quad (12.59)$$

$$\theta_t \frac{1}{1 - N_{t+1}} = w_{t+1} \quad (12.60)$$

For these utility specifications, the first order conditions for the choice of labor look similar to one another, with the exception that in the non-separable case C_t drops out altogether.

Having derived these optimality conditions, let us now think about how consumption and labor supply ought to react to changes in the things which the household takes as given. One can use an indifference curve-budget line diagram to think about the choice of consumption in period t and $t + 1$. Though income is now endogenous because of the choice of labor, treating income as given when thinking about how much to consume gives rise to exactly the same kind of indifference curve budget-line diagram which we encountered in Chapter 9. Consumption will increase if current income increases, but by less than the increase in current income. In other words, the MPC is positive but less than one. Consumption will also increase if the household anticipates an increase in future income. There are competing income and substitution effects at work with regard to the real interest rate. As before, we assume that the substitution effect dominates, so that consumption is decreasing in the real interest rate. Therefore, the qualitative consumption function which we will use is the same as in the earlier model:

$$C_t = C^d(Y_t, Y_{t+1}, r_t) \quad (12.61)$$

One might note some incongruity here. What appears in the household's intertemporal budget constraint is $w_t N_t + D_t$ as income each period, not Y_t . In equilibrium, as we discuss at the end of this chapter, we will see that $w_t N_t + D_t = Y_t - I_t$. So writing the consumption function in terms of Y_t is not quite correct. But doing so does not miss out on any important feature of the model, and is consistent with our previous work in Chapter 9. It is also very common to express the consumption function in terms of aggregate income.

Next, let us think about how N_t and C_t ought to react to a change in the wage. To do this, we need to build a new indifference curve - budget line diagram. To fix ideas, suppose that there is only one period (so that the household does not do any saving). The budget constraint facing the household would be:

$$C_t = w_t N_t + D_t \quad (12.62)$$

N_t is restricted to lie between 0 and 1. When $N_t = 0$ (so $L_t = 1$), then the household's consumption is simply the dividend it receives from the firm, $C_t = D_t$. If the household takes no leisure, so $N_t = 1$, then consumption is the wage plus the dividend. In a graph with C_t on the vertical axis and $L_t = 1 - N_t$ on the horizontal axis, we can plot the budget constraint. The vertical intercept (when $L_t = 0$) is $C_t = w_t + D_t$. The maximum value leisure can take on is 1, at which point $C_t = D_t$. Assume that $D_t > 0$. Between these two points, the budget line slopes down – as leisure goes up, consumption falls at rate w_t . Since leisure cannot go above 1 and we assume $D_t > 0$, this means that there is a kink in the budget constraint at this point. Figure 12.4 plots the hypothetical budget line below:

Figure 12.4: The Consumption-Leisure Budget Line

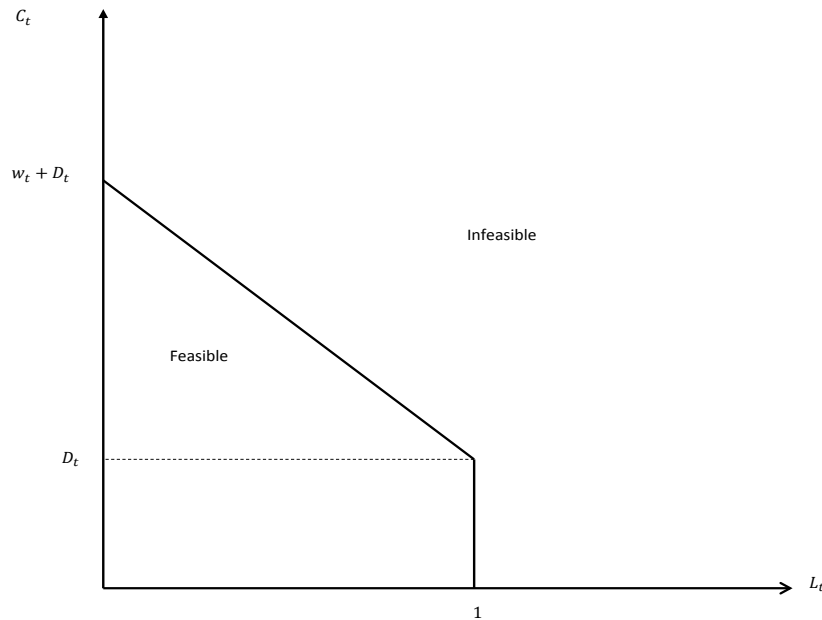

An indifference curve in this setup is a combination of C_t, L_t values which yield a fixed overall level of utility. The slope of the indifference is the ratio of the marginal utilities $-\frac{u_L}{u_C}$. Because of the assumed concavity of preferences, the indifference curve has a bowed-in shape, just like in the dynamic consumption-saving model. A higher indifference curve represents a higher overall level of utility. Hence, we can think about the household's problem as trying to pick C_t, L_t to get on the highest indifference curve possible which does not violate the budget constraint. For this exercise, we rule out the "corner" solutions in which the household would choose either no work or no leisure. As in the two period consumption model, getting on

the highest indifference curve possible subject to the budget line requires that the slope of the indifference curve equals the slope of budget line, or $\frac{u_L}{u_C} = w_t$, which is nothing more than restatement of (12.54). Figure 12.5 below shows a hypothetical situation in which the household chooses $C_{0,t}, L_{0,t}$ (equivalently, $N_{0,t}$) where the indifference curve is tangent to the budget line.

Figure 12.5: Optimal Consumption-Leisure Choice

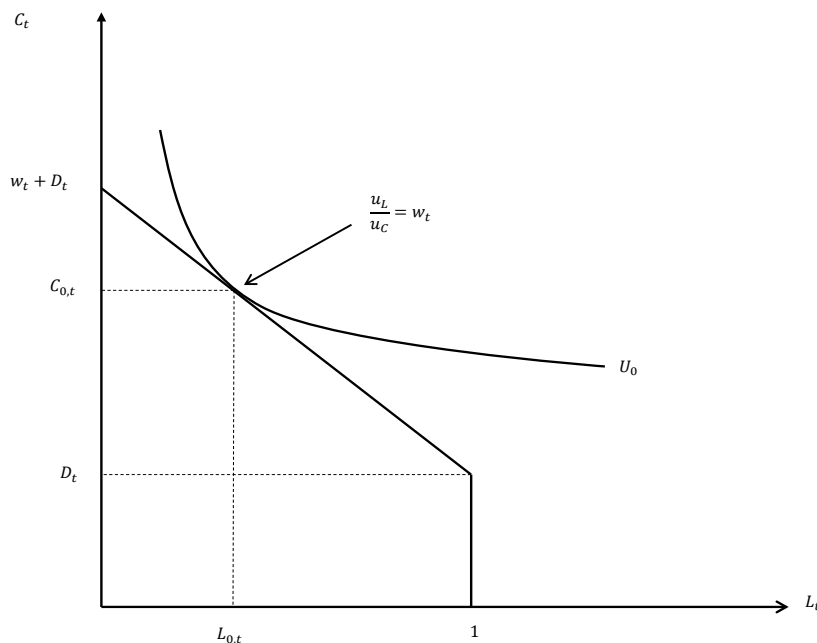

Now, let's consider graphically the effects of an increase in w_t . This has the effect of making the budget line steeper (and increasing the vertical axis intercept). This is shown with the blue line Figure 12.6. To think about how this impacts the choice of consumption and leisure, let's use the tool of isolating income and substitution effects as we did for the effects of a change in r_t in the two period consumption-saving model. In particular, draw in a hypothetical budget line, with slope given by the new w_t , where the household would optimally locate on the original indifference curve, labeled U_0 in the graph. The substitution effect is to substitute away from leisure and into consumption. When w_t goes up, leisure is relatively more expensive (you are foregoing more earnings), and so it seems natural that N_t should rise. But there is also an income effect, which is shown from the change from the hypothetical allocation where U_0 is tangent to the hypothetical budget line to the new indifference curve. Because the original bundle now lies inside the new budget line, there is an income effect wherein the household can get to a higher indifference curve. This income effect involves increasing both C_t and L_t , which means reducing N_t . Effectively, for a given

amount of labor input, a household earns more income, which leads it to desire more leisure and more consumption. The net effect is for consumption to increase, whereas the net effect on L_t (and hence N_t) is ambiguous because of the competing income and substitution effects. The picture has been drawn where the substitution effect dominates, so that L_t falls (and hence N_t rises). This is the empirically plausible case, and unless otherwise noted we shall assume that the substitution effect dominates, so that N_t is increasing in w_t .

Figure 12.6: Optimal Consumption-Leisure Choice, Increase in w_t

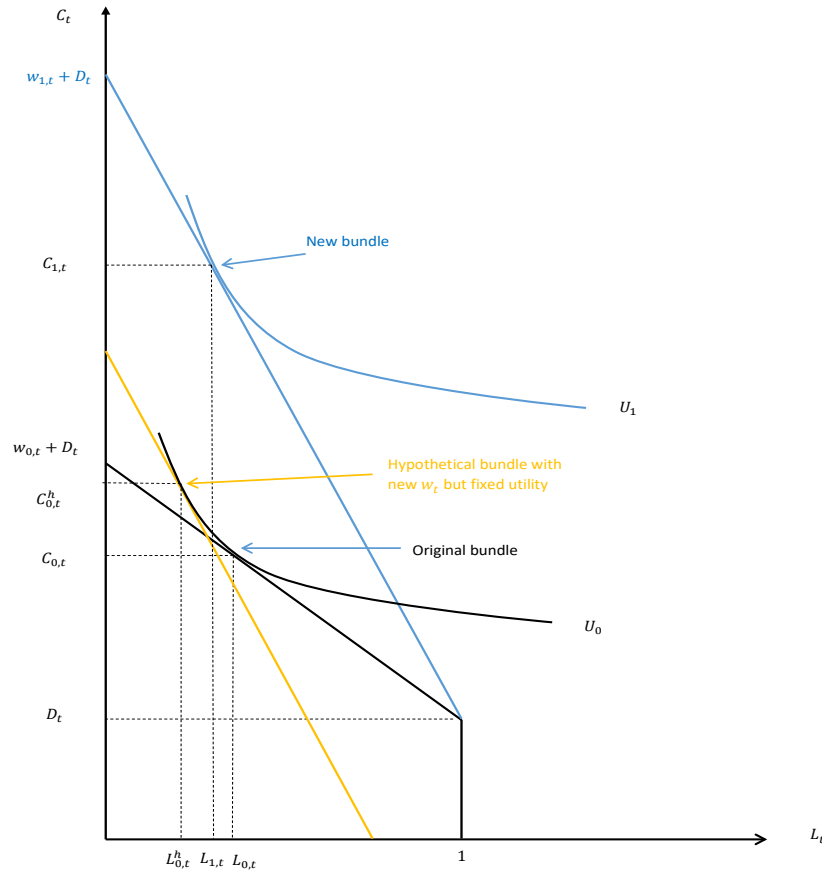

Mathematically, one can see the income and substitution effects at work by focusing on the first order condition for labor supply:

$$\frac{u_L(C_t, 1 - N_t)}{u_C(C_t, 1 - N_t)} = w_t \quad (12.63)$$

In (12.63), when w_t increases, the ratio of marginal utilities must increase. Since we know that consumption will increase, we know that u_C ought to go down, which on its own makes the ratio of the marginal utilities increase. Depending on how much u_C decreases, one could need N_t to increase (L_t to decrease, which would drive u_L up) or decrease (L_t to increase,

which would drive u_L down). We shall assume that the substitution effect always dominates, in a way analogous to how we assumed that the substitution effect of a change in the real interest rate dominates for consumption. By assuming that the substitution effect dominates, we are implicitly assuming that u_C falls by sufficiently little that u_L needs to increase, so L_t needs to fall and N_t needs to rise, whenever w_t goes up.

From looking at (12.63), it becomes clear that anything which might impact consumption (other than w_t) ought to also impact N_t . In terms of the graphs, these are things which would influence the point where the kink in the budget line occurs. In the static setup, this is solely governed by D_t (which one can think of as a stand-in for non-wage income). In a dynamic case, this point would also be influenced by r_t and expectations of future income and wages. We will assume that these other effects are sufficiently small so that they can be ignored. If we were to use the non-separable preference specification discussed in the two examples above, this assumption would be valid. In particular, with that preference specification, (12.63) becomes:

$$\theta_t \frac{1}{1 - N_t} = w_t \quad (12.64)$$

Under this preference specification, C_t drops out altogether, and N_t is solely a function of w_t . With these preferences, there is no income effect of a change in the wage. If w_t goes up, N_t must go up to make $\frac{1}{1 - N_t}$ go down. In the background, we can think of using this preference specification to motivate our assumptions of labor supply. In addition to the real wage, we will allow for an exogenous source of variation in labor. We will denote this via the exogenous variable θ_t , which appears in (12.64) as a parameter influencing the utility flow from leisure. More generally, one can think about θ_t as measuring anything other than the wage which might impact labor supply. We shall assume that when θ_t goes up, N_t goes down for a given wage. The strict interpretation of this is that a higher value of θ means that people value leisure more. Our generic labor supply specification can therefore be written:

$$N_t = N^s(w_t, \theta_t) \quad (12.65)$$

Figure 12.7 plots a hypothetical labor supply function. N_t is increasing in the wage. We have drawn this supply function as a straight line, but more generally it could be a curve. The labor supply curve would shift out to the right (i.e. the household would supply more N_t for a given w_t) if θ_t were to decline.

Figure 12.7: Labor Supply

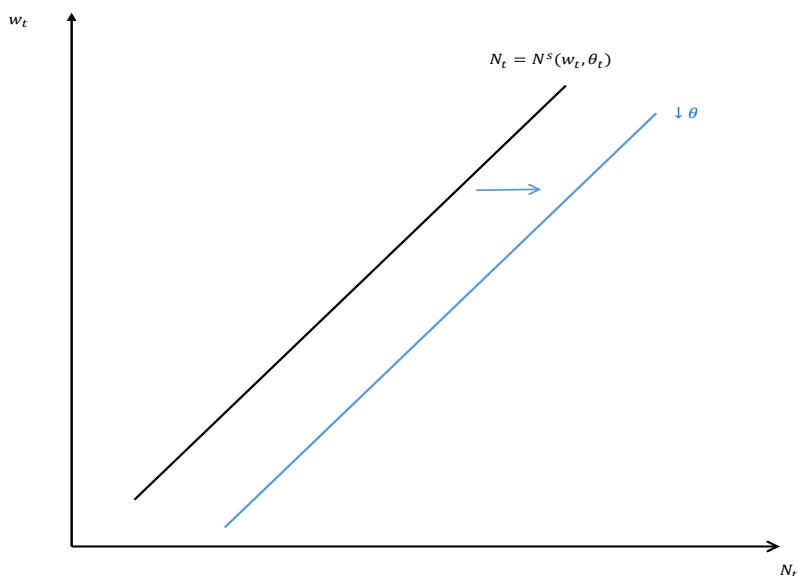

12.3 Financial Intermediary

In our model, there is a financial intermediary (e.g. a bank) operating in the background. The bank intermediates between households, who borrow/save via S_t , and the firm, which needs funding for its capital investment. The financial intermediary takes funds from the household, S_t , and lends them to the firm, B_t^I . The financial intermediary charges the same interest rate on borrowing and saving, r_t , so that the dividend it earns in $t + 1$ is:

$$D_{t+1}^I = r_t B_t^I - r_t S_t \quad (12.66)$$

The financial intermediary here is not very interesting – it does not get to choose anything here, and just passively earns a dividend that is remitted to the owner (the household). As we shall see below, in equilibrium this dividend is zero anyway. Later in the book, we will augment the model wherein the financial intermediary can earn a non-zero profit.

12.4 Equilibrium

As in the endowment economy discussed in Chapter 11, equilibrium is defined as a set of prices and allocations under which all agents are behaving optimally and all markets simultaneously clear. Let us be specific about what this means in the context of the model laid out in this chapter. Agents behaving optimally means that the household behaves according to its consumption function, (12.61), and its labor supply function, (12.65). The firm produces

output according to its production function, (12.1), and demands labor according to (12.17) and investment according to (12.20).

Market-clearing for labor follows naturally from being on both the labor supply and demand curves. Another market here which must clear is the market for savings and investment. In particular, we must have household savings, S_t , equal firm borrowing, B_t^I , which is in turn equal to investment:

$$S_t = B_t^I = I_t \quad (12.67)$$

If this is combined with the household's period t budget constraint and the definition of period t dividends, one gets an aggregate resource constraint, which looks similar to the NIPA expenditure definition of GDP (without government spending or the rest of the world):

$$Y_t = C_t + I_t \quad (12.68)$$

One can then show that the same aggregate resource constraint holds in the future as well. From the household's budget constraint, we have:

$$C_{t+1} = w_{t+1}N_{t+1} + (1 + r_t)S_t + D_{t+1} + D_{t+1}^I \quad (12.69)$$

Plugging in the definitions of dividends, this can be written:

$$C_{t+1} = w_{t+1}N_{t+1} + (1 + r_t)S_t + Y_{t+1} + (1 - \delta)K_{t+1} - w_{t+1}N_{t+1} - (1 + r_t)B_t^I + r_t B_t^I - r_t S_t \quad (12.70)$$

Imposing that $S_t = B_t^I$ and making some other simplifications, this becomes:

$$C_{t+1} - (1 - \delta)K_{t+1} = Y_{t+1} \quad (12.71)$$

Since the capital accumulation equation in $t + 1$ is $K_{t+2} = I_{t+1} + (1 - \delta)K_{t+1}$, and $K_{t+2} = 0$ is a terminal condition, we see that $I_{t+1} = -(1 - \delta)K_{t+1}$. Hence, (12.71) is:

$$Y_{t+1} = C_{t+1} + I_{t+1} \quad (12.72)$$

(12.72) is the same as (12.68), only dated $t + 1$ instead of t . From the perspective of period t , we can think of (12.68) as summarizing loan market clearing – we do not need to keep track of B_t^I or S_t separately. In summary, then, the equilibrium is characterized by the following equations holding:

$$C_t = C^d(Y_t, Y_{t+1}, r_t) \quad (12.73)$$

$$N_t = N^s(w_t, \theta_t) \quad (12.74)$$

$$N_t = N^d(w_t, A_t, K_t) \quad (12.75)$$

$$I_t = I^d(r_t, A_{t+1}, K_t) \quad (12.76)$$

$$Y_t = A_t F(K_t, N_t) \quad (12.77)$$

$$Y_t = C_t + I_t \quad (12.78)$$

Expressions (12.73)-(12.78) comprise six equations in six endogenous variables – w_t and r_t are endogenous prices, while C_t , I_t , N_t , and Y_t are endogenous quantities. A_t , A_{t+1} , θ_t , and K_t are exogenous variables. Y_{t+1} is a future endogenous variable; we will talk a bit more in terms of how to deal with that when we study the equilibrium of the economy graphically in Chapter 17.

12.5 Summary

- Firms choose labor and capital to maximize the present discounted value of dividends. These dividends are rebated to households.
- The firm's demand for labor is increasing in productivity and capital and decreasing in the real wage.
- The firm's demand for capital is forward looking. It depends positively on future productivity and negatively on the real interest rate and the current capital stock.
- The household chooses leisure and consumption to maximize utility. Labor supply may increase or decrease after a change in the real wage as there are offsetting income and substitution effects. Unless otherwise stated, we assume that the substitution effect dominates, and that labor supply is therefore increasing in the real wage.

Key Terms

- Modigliani-Miller theorem
- Dividends

Questions for Review

1. State the five assumptions on the production function we use in this chapter.

2. What is the terminal condition for the firm? Explain the economic logic.
3. Why is investment increasing in future productivity but not affected by current productivity?
4. Paraphrase the Modigliani-Miller theorem.
5. Explain how an increase in the real wage may actually lead the household to supply less labor.
6. Write down the definition of competitive equilibrium in this economy. What equations characterize the equilibrium?

Exercises

1. Suppose that the household only lives for one period. The household's optimization problem is:

$$\max_{C_t, N_t} U = \ln C_t + \theta_t \ln(1 - N_t)$$

s.t.

$$C_t = w_t N_t$$

In this problem, the household receives no dividend from the firm.

- (a) Solve for the optimality condition characterizing the household problem.
 - (b) From this optimality condition, what can you say about the effect of w_t on N_t ? What is your explanation for this finding?
2. **Excel Problem.** Suppose that you have a firm with a Cobb-Douglas production function for production in period t :

$$Y_t = A_t K_t^\alpha N_t^{1-\alpha}$$

The only twist relative to our setup in the main text is that the firm does not use labor to produce output in period $t + 1$. The production function in that period is:

$$Y_{t+1} = A_{t+1} K_{t+1}^\alpha$$

- (a) Write down the optimization problem for the firm in this setup. It has to pay labor in period t , w_t , and it discounts future dividends by $\frac{1}{1+r_t}$. It must borrow to finance its investment at r_t . The capital accumulation equation is standard.

- (b) Using this specification of production, derive the first order optimality conditions for the optimal choices of N_t and K_{t+1} .
- (c) Re-arrange the first order optimality conditions to derive explicit expression for the demand for N_t and the demand for K_{t+1} .
- (d) Re-arrange your answer from the previous part, making use of the capital accumulation equation, to solve for an expression for I_t .
- (e) Create an Excel file. Assume the following values for exogenous parameters: $\alpha = 1/3$, $\delta = 0.1$, $A_t = 1$, $A_{t+1} = 1$, and $K_t = 2$. Create column of possible values of w_t , ranging from a low of 1 to a high of 1.5, with a step of 0.01 between entries (i.e. create a column going from 1 to 1.01 to 1.02 all the way to 1.5). For each possible value of w_t , solve for a numeric value of N_t . Plot w_t against the optimal value of N_t . Does the resulting demand curve for labor qualitatively look like Figure 12.2?
- (f) Suppose that A_t increases to 1.1. Re-calculate the optimal value of N_t for each value of w_t . Plot the resulting N_t values against w_t in the same plot as what you did on the previous part. What does the increase in A_t do to the position of the labor demand curve?
- (g) Go back to assuming the parameter and exogenous values we started with. Create a grid of values of r_t ranging from a low 0.02 to a high of 0.1, with a space of 0.001 between (i.e. create a column going from 0.020, to 0.021, to 0.022, and so on). For each value of r_t , solve for the optimal level of I_t . Create a graph with r_t on the vertical axis and I_t on the horizontal axis. Plot this graph. Does it qualitatively look like Figure 12.3?
- (h) Suppose that A_{t+1} increases to 1.1. For each value of r_t , solve for the new optimal I_t . Plot this in the same figure as on the previous part. What does the increase in A_{t+1} do to the position of the investment demand curve?

Chapter 13

Fiscal Policy

In this chapter we augment the model from Chapter 12 to include a government. This government consumes some of the economy's output each period. We do not formally model the usefulness of this government expenditure. In reality, government spending is motivated for the provision of *public goods*. Public goods are goods which are non-exclusionary in nature, by which is meant that once the good has been produced, it is impossible (or nearly so) for the producer to exclude individuals from consuming it. An example is military defense. All citizens in a country benefit from the defense its military provides, whether they want to or not. A private military provider would be fraught with problems, because it would be difficult or impossible for the private provider to entice individuals to pay for military services. As such, military services would be under-provided left to the private market. Other examples of public goods include roads, bridges, schools, and parks.

We will assume that the government can finance its expenditure with a mix of taxes and debt. We will assume that taxes are lump sum, in the sense that the amount of tax an agent pays is independent of any actions taken by that agent. This is an unrealistic description of reality but nevertheless greatly simplifies the analysis and will provide some important insights.

13.1 The Government

The model is the same as in Chapter 12, with time lasting for two periods, t (the present) and $t + 1$ (the future). The government does an exogenous amount of expenditure in each period, G_t and G_{t+1} . As noted above, we do not model the usefulness of this expenditure, nor do we endogenize the government's choice of its expenditure. The government faces budget constraints each period in a similar way to the household. These are:

$$G_t \leq T_t + B_t^G \tag{13.1}$$

$$G_{t+1} + r_t B_t^G \leq T_{t+1} + B_{t+1}^G - B_t^G \tag{13.2}$$

In these budget constraints, T_t and T_{t+1} denote tax revenue raised by the government in each period. In the period t constraint, (13.1), B_t^G is the amount of debt which the government issues in period t . The sign convention is that $B_t^G > 0$ is debt, while $B_t^G < 0$ would correspond to a situation in which the government saves. In other words, in period t , the government can finance its expenditure, G_t , by raising taxes, T_t , or issuing debt, B_t^G . In period $t + 1$, the government has two sources of expenditure – its spending, G_{t+1} , and interest payments on its outstanding debt, $r_t B_t^G$. If $B_t^G < 0$, then this corresponds to interest revenue. The government can again finance its expenditure by raising taxes, T_{t+1} , or issuing more debt, $B_{t+1}^G - B_t^G$, where this term corresponds to the change in the quantity of outstanding debt.

As in the case of the household, we assume that the government cannot die in debt, which requires $B_{t+1}^G \leq 0$. The government would not want to die with a positive stock of savings, so $B_{t+1}^G \geq 0$. Put together, this gives us a terminal condition of $B_{t+1}^G = 0$. If we further assume that the government's budget constraints hold with equality each period, we can combine (13.1) and (13.2) to get an intertemporal budget constraint for the government:

$$G_t + \frac{G_{t+1}}{1 + r_t} = T_t + \frac{T_{t+1}}{1 + r_t} \quad (13.3)$$

The government's intertemporal budget constraint has exactly the same flavor as the household's intertemporal budget constraint. In words, it requires that the present discounted value of the stream of spending equals the present discount value of the stream of tax revenue. In other words, while the government's budget need not balance (i.e. $G_t = T_t$ or $G_{t+1} = T_{t+1}$) in any particular period, it must balance in a present value sense.

13.2 Fiscal Policy in an Endowment Economy

Let us first incorporate fiscal policy into the endowment economy framework explored in Chapter 11. We will later move on to a production economy. There exists a representative household with a standard lifetime utility function. The household faces a sequence of budget constraints given by:

$$C_t + S_t \leq Y_t - T_t \quad (13.4)$$

$$C_{t+1} + S_{t+1} \leq Y_{t+1} - T_{t+1} + (1 + r_t)S_t \quad (13.5)$$

These are the same flow budgets constraints we have already encountered, but include a tax payment to the government each period of T_t and T_{t+1} . These taxes are *lump sum* in the sense that they are additive in the budget constraint – the amount of tax that a household

pays is independent of its income or any other choices which it makes. We impose the terminal condition that $S_{t+1} = 0$, and assume that the flow budget constraints hold with equality in both periods. This gives rise to an intertemporal budget constraint for the household:

$$C_t + \frac{C_{t+1}}{1+r_t} = Y_t - T_t + \frac{Y_{t+1} - T_{t+1}}{1+r_t} \quad (13.6)$$

In words, (13.6) requires that the present discounted value of the stream of consumption equal the present discounted value of the stream of net income, where $Y_t - T_t$ denotes net income in period t (and similarly for period $t + 1$).

The household's lifetime utility optimization problem gives rise to the standard Euler equation:

$$u'(C_t) = \beta(1+r_t)u'(C_{t+1}) \quad (13.7)$$

We can again use an indifference curve - budget line setup to graphically think about what the consumption function will be. Before doing so, note that the household's intertemporal budget constraint can be written:

$$C_t + \frac{C_{t+1}}{1+r_t} = Y_t + \frac{Y_{t+1}}{1+r_t} - \left[T_t + \frac{T_{t+1}}{1+r_t} \right] \quad (13.8)$$

In other words, because the tax payments are additive (i.e. lump sum), we can split the income side of the intertemporal budget constraint into the present discounted value of the stream of income less the present discounted value of the stream of tax payments. But, since the household knows that the government's intertemporal budget constraint must hold, the household knows that the present discounted value of tax payments must equal the present discounted value of government spending:

$$C_t + \frac{C_{t+1}}{1+r_t} = Y_t + \frac{Y_{t+1}}{1+r_t} - \left[G_t + \frac{G_{t+1}}{1+r_t} \right] \quad (13.9)$$

(13.9) can be re-arranged to yield:

$$C_t + \frac{C_{t+1}}{1+r_t} = Y_t - G_t + \frac{Y_{t+1} - G_{t+1}}{1+r_t} \quad (13.10)$$

In other words, T_t and T_{t+1} do not appear in the intertemporal budget constraint. From the household's perspective, it is as if the government balances its budget each period, with $G_t = T_t$ and $G_{t+1} = T_{t+1}$. Figure 13.1 plots the budget line facing the household. It is simply a graphical depiction of (13.10). Points inside the budget line are feasible, points outside the budget line are infeasible. The slope of the budget line is $-(1+r_t)$.

Figure 13.1: Budget Line

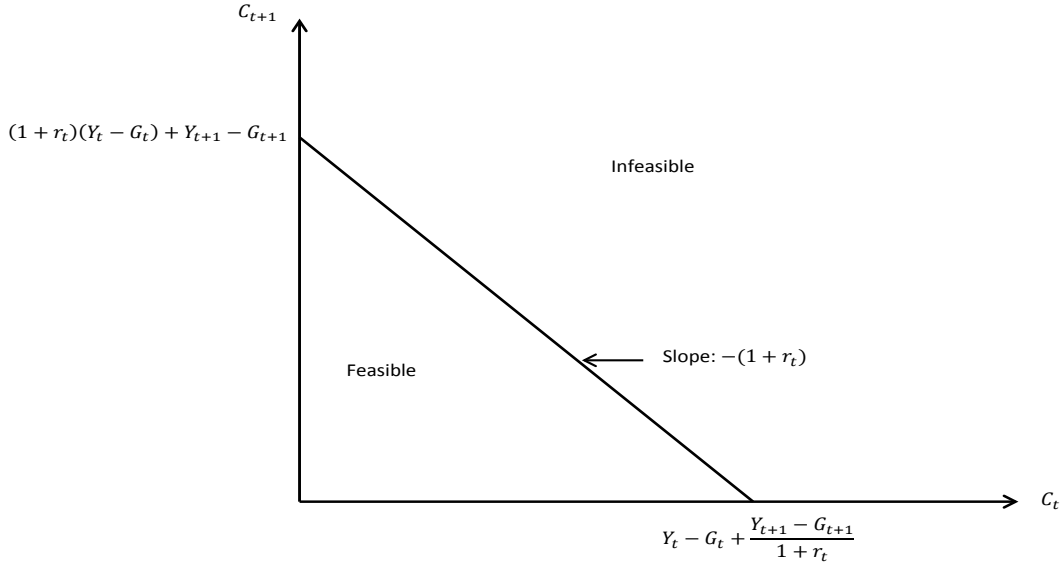

The household's objective is to choose a consumption bundle, (C_t, C_{t+1}) , so as to locate on the highest possible indifference curve which does not violate the budget constraint. This involves locating at a point where the indifference curve is just tangent to the budget line (i.e. where the Euler equation holds). This is qualitative identical to what was seen in Chapter 9. From the household's perspective, an increase in G_t is equivalent to a decrease in Y_t (there are fewer resources available for the household to consume) and similarly for G_{t+1} . T_t and T_{t+1} are irrelevant from the household's perspective. We can therefore intuit that the consumption function takes the form:

$$C_t = C(Y_t - G_t, Y_{t+1} - G_{t+1}, r_t) \quad (13.11)$$

Now that we understand household optimality, let us turn to market-clearing. Market-clearing requires that $B_t^G = S_t$. In other words, household saving must equal government borrowing (equivalently, household borrowing must equal government saving). From (13.1), we have that $B_t^G = G_t - T_t$. Inserting this for S_t into (13.4) yields:

$$Y_t = C_t + G_t \quad (13.12)$$

In other words, the aggregate market-clearing condition requires that total output equal the sum of private, C_t , and public, G_t , consumption. This is equivalent to imposing that aggregate saving is zero, where aggregate saving is $S_t - B_t^G$ (i.e. household saving plus public saving, where $-B_t^G$ is public saving).

Equations (13.12) and (13.11) characterize the equilibrium of the economy. This is two equations in two endogenous variables, C_t and r_t . Y_t , Y_{t+1} , G_t , and G_{t+1} are all exogenous and hence taken as given. Note that T_t , T_{t+1} , and B_t^G (government debt issuance) do not appear in the equilibrium conditions. This means that these variables are *irrelevant* for the determination of equilibrium prices and quantities. This does not mean that fiscal policy is irrelevant – G_t and G_{t+1} are going to be relevant for equilibrium quantities and prices. But the level of taxes and debt are irrelevant.

This discussion forms the basis of what is known as *Ricardian Equivalence*. Attributed to the famous early economist David Ricardo, this hypothesis was revived in its modern form by Robert Barro in a series of papers Barro (1974) and Barro (1979). The essential gist of Ricardian equivalence is that the method of government finance is irrelevant for understanding the effects of changes in government expenditure. Put differently, a change in G_t will have the same effect on the equilibrium of the economy whether it is financed by an increase in taxes, by increasing debt, or some combination of the two. Corollaries are that the level of government debt is irrelevant for understanding the equilibrium behavior of the economy and that changes in taxes, not met by changes in either current or future government spending, will have no effect on the equilibrium of the economy.

The intuition for Ricardian Equivalence can be understood as follows. Suppose that the government increases G_t by issuing debt, with no change in taxes. This issuance of debt necessitates an increase in future taxes in an amount equal in present value to the current increase in spending. Since all the household cares about is the present discounted value of tax obligations, the household is indifferent to whether the tax is paid in the present versus the future, so long as the present value of these payments are the same. In other words, from the household's perspective, it is as if the government increases the tax in the present by an amount equal to the change in spending. Furthermore, suppose that the government cuts taxes in the present, T_t , with no announced change in current or future spending. For the government's intertemporal budget constraint to hold, this will necessitate an increase in the future tax by an amount equal in present value to the decrease in current taxes. Since all the household cares about is the present discounted value of tax obligations, the cut in T_t is irrelevant for the household's behavior. Finally, government debt is irrelevant. Suppose that the government issues positive debt, $B_t^G > 0$. This is held by the household with $S_t > 0$. This stock of savings held by the household (i.e. its holdings of government debt) is *not* wealth for the household. Why not? The household will have to pay higher future taxes to pay off the debt – in essence, the household will pay itself principal plus interest on the outstanding debt in the future, through the government, in an amount equal in present value to the household's current stock of savings.

Ricardian Equivalence is a stark proposition. It means that the level of government debt is irrelevant, that tax-financed government spending changes have the same equilibrium effects as deficit-financed changes in spending, and that the level of outstanding government debt is irrelevant. Does Ricardian Equivalence hold in the real world? Likely not. Ricardian Equivalence only holds in special cases. First, taxes must be lump sum (i.e. additive). If the amount of tax that households pay depends on actions they take, then Ricardian Equivalence will not hold. Second, Ricardian Equivalence requires that there be no liquidity constraints – i.e. households must be able to freely borrow and save at the same rate as the government. Third, Ricardian Equivalence requires that households are forward-looking and believe that the government’s intertemporal budget constraint must hold. Fourth, Ricardian Equivalence requires that the government and household have the same lifespan. If the government “outlives” households (as would be the case in what are called overlapping generations models, where each period one generation of households dies and another is born), then the timing of tax collection will matter to consumption and saving decisions of households. None of these conditions are likely to hold in the real world. Nevertheless, the insights from the Ricardian Equivalence are useful to keep in mind when thinking about real world fiscal policy.

13.2.1 Graphical Effects of Changes in G_t and G_{t+1}

We can use the IS and Y^s curves from Chapter 11 to analyze the equilibrium consequences of changes in current or future government spending. The IS curve shows the set of (r_t, Y_t) pairs consistent with total income equaling total expenditure, where total expenditure is $C_t + G_t$, when the household is behaving optimally. The presence of government spending does not impact the derivation or qualitative shape of the IS curve. Since we are working in an endowment economy in which current production is exogenous, the Y^s curve is simply a vertical line at some exogenous value of output, $Y_{0,t}$. Total autonomous expenditure (i.e. desired expenditure independent of current income) is given by:

$$E_0 = C^d(-G_t, Y_{t+1} - G_{t+1}, r_t) + G_t \quad (13.13)$$

Changes in G_t or G_{t+1} will influence autonomous expenditure (i.e. the intercept of the desired expenditure line), and will therefore impact the position of the IS curve. Consider first an exogenous increase in G_t . This has two effects on autonomous expenditure, as can be seen in (13.13). There is a direct effect wherein an increase in G_t raises autonomous expenditure one-for-one. There is an indirect effect wherein the increase in G_t depresses consumption. Which effect dominates? It turns out that the direct effect dominates, because the MPC is less than one. The partial derivative of autonomous expenditure with respect to

government spending is:

$$\frac{\partial E_0}{\partial G_t} = -\frac{\partial C^d}{\partial G_t} + 1 \quad (13.14)$$

Since we denote $\frac{\partial C^d}{\partial G_t}$ by MPC, which is less than one, this derivative works out to $1 - MPC > 0$. Hence, autonomous expenditure increases when government spending increases, but by less than the increase in government spending. This shifts the vertical axis intercept of the expenditure line up, which in turn causes the IS curve to shift to the right – i.e. for a given real interest rate, $r_{0,t}$, the level of income at which income equals expenditure is now larger. This is shown in Figure 13.2 below with the blue lines:

Figure 13.2: Increase in G_t

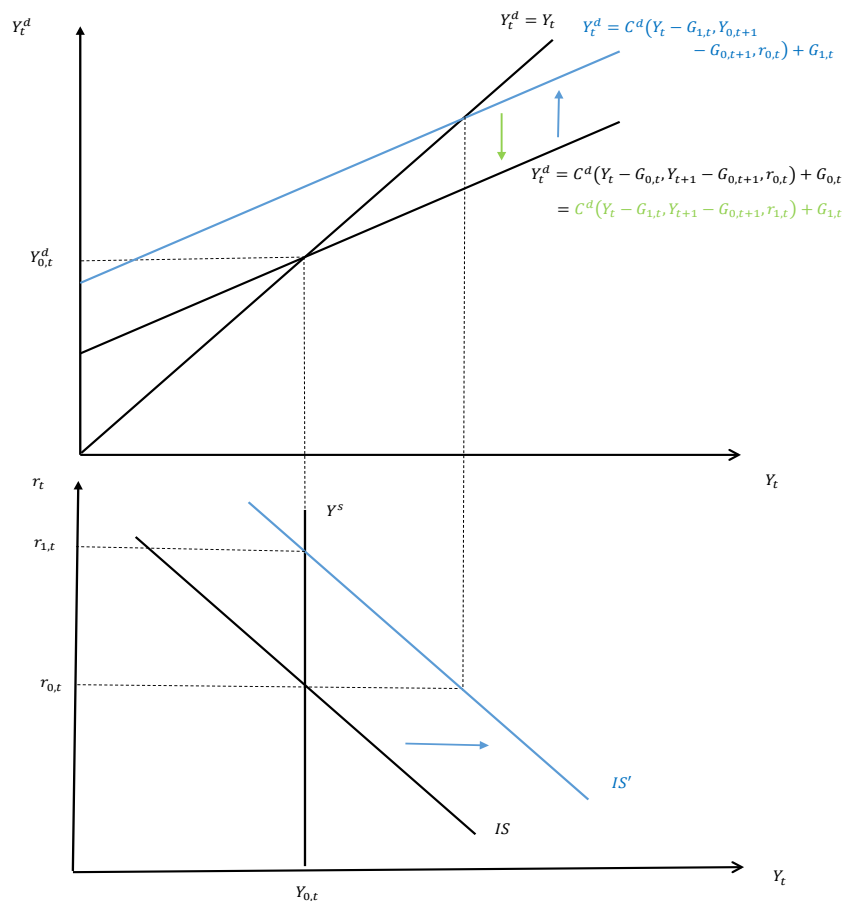

The rightward shift of the IS curve is shown in blue. There is no shift of the Y^s curve since current output is exogenous. The rightward shift of the IS curve along a fixed Y^s curve means that the real interest rate must rise from $r_{0,t}$ to $r_{1,t}$. The higher real interest rate

reduces autonomous expenditure through an effect on consumption, in such a way that the expenditure line shifts back down to where it started so as to be consistent with unchanged Y_t . This effect is shown in the figure with the green arrow.

Since output is unchanged in equilibrium, it must be the case that consumption falls by the amount of the increase in government spending. In other words, consumption is completely “crowded out” by the increase in G_t . The complete crowding out of consumption is *not* a consequence of Ricardian Equivalence, but rather emerges because of the fact that total output is fixed in this example. The intuition for this is the following. When G_t increases, the household feels poorer and acts as though its current tax obligations are higher. It would like to reduce its consumption some, but by less than the increase in G_t holding the interest rate fixed (i.e. the MPC is less than 1). But in equilibrium, market-clearing dictates that consumption falls by the full amount of the increase in G_t (since Y_t is fixed). Hence, r_t must rise to further discourage consumption, so that consumption falling by the full amount of the increase in G_t is consistent with the household’s consumption function.

Next, consider an anticipated increase in future government spending, from $G_{0,t+1}$ to $G_{1,t+1}$. This only affects current autonomous expenditure through an effect on consumption. This effect is negative. Hence, autonomous expenditure declines, so the expenditure line shifts down. This results in an inward shift of the IS curve. This is shown in blue in Figure 13.3.

Figure 13.3: Increase in G_{t+1}

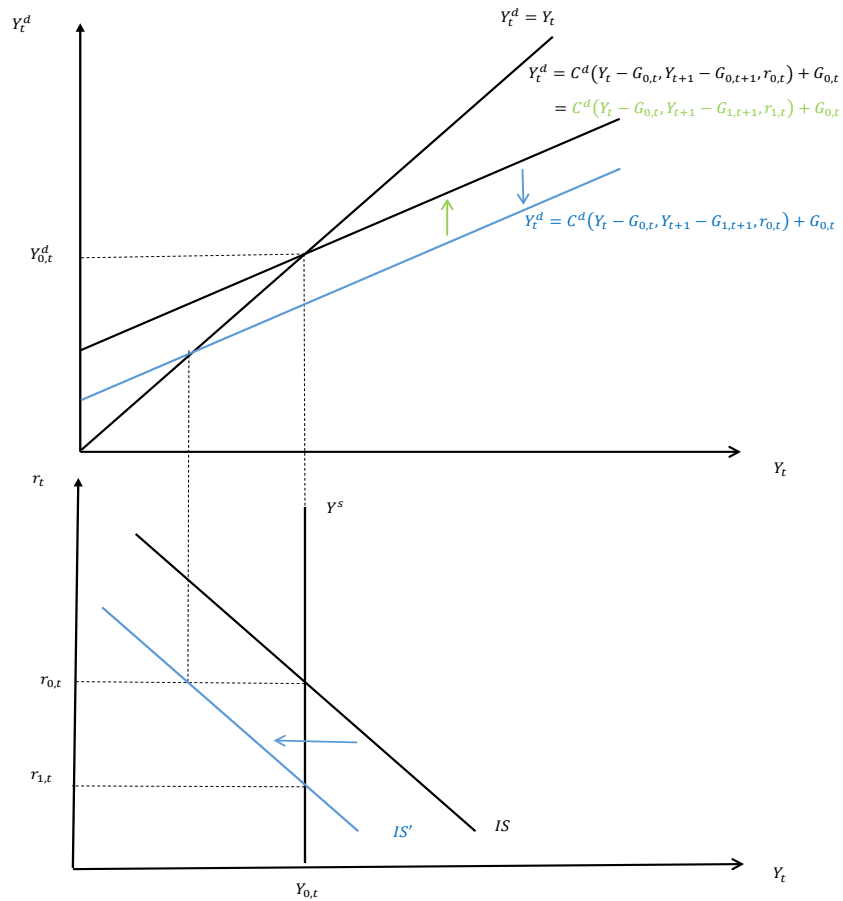

The inward shift of the IS curve, coupled with no shift of the Y^s curve, means that the real interest rate must fall in equilibrium, from $r_{0,t}$ to $r_{1,t}$. The lower real interest rate boosts autonomous expenditure to the point where the expenditure line shifts back to where it began. In equilibrium, there is no change in C_t (since there is no change in Y_t or current G_t). Effectively, the anticipated increase in G_{t+1} makes the household want to reduce its current consumption and therefore increase its saving. In equilibrium, this is not possible. So the real interest rate must fall to discourage the household from increasing its saving.

13.2.2 Algebraic Example

Suppose that the household has log utility over consumption. This means that the Euler equation is:

$$\frac{C_{t+1}}{C_t} = \beta(1 + r_t) \quad (13.15)$$

Solve the Euler equation for C_{t+1} , and plug back into the household's intertemporal budget constraint, (13.10). Solving for C_t gives the consumption function for this utility specification:

$$C_t = \frac{1}{1 + \beta}(Y_t - G_t) + \frac{1}{1 + \beta} \frac{Y_{t+1} - G_{t+1}}{1 + r_t} \quad (13.16)$$

Total desired expenditure is the sum of this plus current government spending:

$$Y_t^d = \frac{1}{1 + \beta}(Y_t - G_t) + \frac{1}{1 + \beta} \frac{Y_{t+1} - G_{t+1}}{1 + r_t} + G_t \quad (13.17)$$

Impose the equality between income and expenditure, and solve for Y_t , which gives an expression for the IS curve:

$$Y_t = G_t + \frac{1}{\beta} \frac{Y_{t+1} - G_{t+1}}{1 + r_t} \quad (13.18)$$

Now, solve for r_t :

$$1 + r_t = \frac{1}{\beta} \frac{Y_{t+1} - G_{t+1}}{Y_t - G_t} \quad (13.19)$$

From (13.19), it is clear that an increase in G_t raises r_t , while an increase in G_{t+1} lowers r_t .

13.3 Fiscal Policy in a Production Economy

Now, we shall incorporate fiscal policy into the production economy outlined in Chapter 12. The government's budget constraints are the same as outlined at the beginning of this chapter. There are now two types of private actors – the representative household and firm. We assume that only the household pays taxes, which are again assumed to be lump sum. It would not change the outcome of the model to instead assume that the firm paid taxes to the government so long as those taxes are also lump sum.

The household faces the following sequence of budget constraints:

$$C_t + S_t \leq w_t N_t - T_t + D_t \quad (13.20)$$

$$C_{t+1} + S_{t+1} \leq w_{t+1} N_{t+1} - T_{t+1} + D_{t+1} + D_{t+1}^I + (1 + r_t) S_t \quad (13.21)$$

This is the same as in Chapter 12, with the addition that the household pays taxes, T_t and

T_{t+1} , to the government in each period. w_t denotes the real wage received by the household, while D_t is a dividend paid out from the household's ownership of the firm. D_{t+1}^I is again the dividend the household receives from its ownership in the financial intermediary. Imposing the terminal condition that $S_{t+1} = 0$ and assuming that each constraint holds with equality yields the intertemporal budget constraint for the household, which says that the present discounted value of net income for the household must equal the present discounted value of the stream of consumption:

$$C_t + \frac{C_{t+1}}{1+r_t} = w_t N_t - T_t + D_t + \frac{w_{t+1} N_{t+1} - T_{t+1} + D_{t+1} + D_{t+1}^I}{1+r_t} \quad (13.22)$$

Because taxes paid in both periods t and $t+1$ are additive, (13.22) can be written:

$$C_t + \frac{C_{t+1}}{1+r_t} = w_t N_t + D_t + \frac{w_{t+1} N_{t+1} + D_{t+1} + D_{t+1}^I}{1+r_t} - \left[T_t + \frac{T_{t+1}}{1+r_t} \right] \quad (13.23)$$

Because the household will anticipate that the government's intertemporal budget constraint will hold with equality, (13.3), we can re-write the household's intertemporal budget constraint as:

$$C_t + \frac{C_{t+1}}{1+r_t} = w_t N_t - G_t + D_t + \frac{w_{t+1} N_{t+1} - G_{t+1} + D_{t+1} + D_{t+1}^I}{1+r_t} \quad (13.24)$$

In other words, just like in the endowment economy, the household's intertemporal budget constraint can be written as though the government balances its budget each period (with $T_t = G_t$ and $T_{t+1} = G_{t+1}$), whether the government does or does not in fact do this.

The first order conditions characterizing a solution to the household's problem are an Euler equation for consumption and a static labor supply first order condition for both periods t and $t+1$:

$$u_C(C_t, 1 - N_t) = \beta(1+r_t)u_C(C_{t+1}, 1 - N_{t+1}) \quad (13.25)$$

$$u_L(C_t, 1 - N_t) = w_t u_C(C_t, 1 - N_t) \quad (13.26)$$

$$u_L(C_{t+1}, 1 - N_{t+1}) = w_{t+1} u_C(C_{t+1}, 1 - N_{t+1}) \quad (13.27)$$

These conditions are exactly the same as we encountered before. Neither government spending, nor government debt, nor taxes appear in these conditions. Mathematically, this is a consequence of the fact that the fiscal terms enter only additively into the household's flow budget constraints. From these conditions we can intuit that there exists a consumption function wherein the household cares about income net of government spending each period

and the interest rate, and a labor supply condition wherein the quantity of labor supplied depends on the real wage and an exogenous term which we have labeled θ_t :

$$C_t = C^d(Y_t - G_t, Y_{t+1} - G_{t+1}, r_t) \quad (13.28)$$

$$N_t = N^s(w_t, \theta_t) \quad (13.29)$$

(13.28) is qualitatively the same as in the endowment economy – the household behaves as though the government balances its budget each period, whether this is in fact the case or not. We make the same assumptions on labor supply – labor supply is increasing in the real wage and decreasing in θ_t , which we take to be an exogenous source of fluctuations in labor supply such as a preference shock.¹

The firm side of the model is exactly the same as in Chapter 12. As such, the labor demand and investment demand curves are identical to what we had before:

$$N_t = N^d(w_t, A_t, K_t) \quad (13.30)$$

$$I_t = I^d(r_t, A_{t+1}, K_t) \quad (13.31)$$

Market-clearing requires that household saving plus government saving (less government borrowing) equal investment: $S_t - B_t^G = I_t$. In essence, $S_t - B_t^G$ is the total amount saved with the financial intermediary, which must in turn equal investment from the representative firm. Since $B_t^G = G_t - T_t$, plugging this into the household's first period budget constraint at equality yields:

$$C_t + I_t + G_t - T_t = w_t N_t - T_t + D_t \quad (13.32)$$

In (13.32), the T_t terms on both sides of the equality cancel out. The dividend paid out by the firm equals $Y_t - w_t N_t$. Plugging this into (13.32) yields the aggregate resource constraint:

$$Y_t = C_t + I_t + G_t \quad (13.33)$$

The full set of equilibrium conditions are given below:

¹As noted in Chapter 12, in general labor supply should be impacted by anything relevant for consumption. Since higher G_t results in lower C_t for given values of Y_t and r_t , it would seem plausible that higher G_t would encourage the household to work *more*. This would be true in a preference specification allowing for such wealth effects, but as noted in the introduction to the book, we are implicitly focusing attention on preferences of the sort emphasized by Greenwood, Hercowitz, and Huffman (1988) where there are no wealth effects and where (13.29) holds exactly.

$$C_t = C^d(Y_t - G_t, Y_{t+1} - G_{t+1}, r_t) \quad (13.34)$$

$$N_t = N^s(w_t, \theta_t) \quad (13.35)$$

$$N_t = N^d(w_t, A_t, K_t) \quad (13.36)$$

$$I_t = I^d(r_t, A_{t+1}, K_t) \quad (13.37)$$

$$Y_t = A_t F(K_t, N_t) \quad (13.38)$$

$$Y_t = C_t + I_t + G_t \quad (13.39)$$

These are identical to the equilibrium conditions presented in Chapter 12, save for the fact that G_t and G_{t+1} are arguments of the consumption function and that G_t appears in the aggregate resource constraint. These six equations feature six endogenous variables – Y_t , N_t , C_t , I_t , w_t , and r_t – with the following exogenous variables: G_t , G_{t+1} , A_t , A_{t+1} , θ_t , and K_t . As in the endowment economy setup, government taxes, T_t and T_{t+1} , as well as government debt, B_t^G , do not appear anywhere in these equilibrium conditions. Ricardian Equivalence still holds for the same intuitive reasons as in the endowment economy model. The level of government debt is again irrelevant.

13.4 Summary

- The government finances its spending by collecting lump sum taxes and issuing debt. Although we could model useful government expenditure, we assume it is strictly wasteful.
- Despite having no control over the time path of government expenditures, the household behaves as if the government balances its budget every period. That is, the household only cares about the present discounted value of its tax liability. Since the present discounted value of taxes equals the present discounted value of spending, the time path is irrelevant.
- An increase in current government spending raises autonomous expenditure, but less than one for one. In an endowment economy equilibrium, consumption drops one for one with a rise in current government spending and the real interest rate increases.
- Ricardian equivalence also holds in a production economy where output is endogenous.

Key Terms

- Lump sum taxes
- Ricardian equivalence theorem

Questions for Review

1. Explain the extent you agree with this statement: Ricardian equivalence shows that government deficits do not matter.
2. Explain the logical error in this statement: Government spending financed by issuing bonds will not decrease desired consumption because bonds are simply debt obligations we owe to ourselves.
3. Politicians often talk about how tax cuts will stimulate consumption. Discuss why this claim is incomplete.
4. List the assumptions of the Ricardian Equivalence theorem.
5. Graphically analyze an increase in G_t in an endowment economy. Clearly explain the economic intuition.
6. Graphically analyze an increase in G_{t+1} in an endowment economy. Clearly explain the economic intuition.

Exercises

1. Suppose that we have an economy with many identical households. There is a government that exogenously consumes some output and pays for it with lump sum taxes. Lifetime utility for a household is:

$$U = \ln C_t + \beta \ln C_{t+1}$$

The household faces two within period budget constraints given by:

$$C_t + S_t = Y_t - T_t$$

$$C_{t+1} = Y_{t+1} - T_{t+1} + (1 + r_t)S_t$$

- (a) Combine the two budget constraints into one intertemporal budget constraint.
- (b) Use this to find the Euler equation. Is the Euler equation at all affected by the presence of taxes, T_t and T_{t+1} ?

- (c) Use the Euler equation and intertemporal budget constraint to derive an expression for the consumption function.

The government faces two within period budget constraints:

$$G_t + S_t^G = T_t$$

$$G_{t+1} = T_{t+1} + (1 + r_t)S_t^G$$

- (d) In equilibrium, what must be true about S_t and S_t^G ?
- (e) Combine the two period budget constraints for the government into one intertemporal budget constraint.
- (f) Suppose that the representative household knows that the government's intertemporal budget constraint must hold. Combine this information with the household's consumption function you derived above. What happens to T_t and T_{t+1} ? What is your intuition for this?
- (g) Equilibrium requires that $Y_t = C_t + G_t$. Plug in your expression for the consumption function (assuming that the household knows the government's intertemporal budget constraint must hold) to derive an expression for Y_t .
- (h) Derive an expression for the “fixed interest rate multiplier,” i.e. $\frac{dY_t}{dG_t}|_{dr_t=0}$.
- (i) Assuming that Y_t is exogenous, what must happen to r_t after an increase in G_t ?
- (j) Now, assume the same setup but suppose that the household *does not* anticipate that the government's intertemporal budget constraint will hold – in other words, do not combine the government's intertemporal budget constraint with the household's consumption function as you did on part (f). Repeat part (h), deriving an expression for the “fixed interest rate multiplier” while not assuming that the household anticipates the government's budget constraint holding. Is it bigger or smaller than you found in (h)?
- (k) Since Y_t is exogenous, what must happen to r_t after an increase in G_t in this setup? Will the change in r_t be bigger or smaller here than what you found in part (i)?
- (l) For the setup in which the household does not anticipate that the government's intertemporal budget constraint must hold, what will be the “fixed interest rate tax multiplier”, i.e. $\frac{dY_t}{dT_t}|_{dr_t=0}$? Is this different

than what the tax multiplier would be if the household were to anticipate that the government's intertemporal budget constraint must bind? Is it smaller or larger than the fixed interest rate multiplier for government spending (assuming that the household does not anticipate that the government's intertemporal budget constraint will hold)?

2. Consider a representative agent with the utility function

$$U = \ln C_t + \frac{\theta}{2}(1 - N_t)^2$$

The budget constraint is

$$C_t = w_t N_t + D_t$$

where w_t is the wage and D_t is non-wage income (i.e. a dividend from ownership in the firm). The agent lives for only one period (period t), and hence its problem is static.

- (a) Derive an optimality condition characterizing optimal household behavior.
- (b) Solve for the optimal quantities of consumption and labor.
- (c) Suppose that the government implements a lump sum subsidy to all workers, T_t . It engages in no spending and has no budget constraint to worry about; hence it can choose T_t however it pleases. The household's budget constraint is now:

$$C_t = w_t N_t + D_t + T_t.$$

How are the optimal quantities of C_t and N_t affected by the introduction of the subsidy? Specifically, do people consume more or less leisure? What is the economic intuition for this?

- (d) Instead of a lump sum subsidy, suppose the government subsidizes work. With the subsidy, the workers receive an effective wage rate of $w_t(1 + \tau_t)$. The budget constraint is

$$C_t = w_t(1 + \tau_t)N_t + D_t.$$

How are the optimal quantities of C and N affected by the introduction of the subsidy? Specifically, do people consume more or less leisure? What is the economic intuition for this?

- (e) Suppose the government wants to help workers, but does not want to discourage work. Which of these subsidies will be more successful?
3. Consider a firm which operates for two periods. It produces output each period according to the following production function:

$$Y_t = A_t K_t^\alpha \quad 0 < \alpha < 1.$$

The current capital stock is exogenously given. The firm can influence its future capital stock through investment. The two capital accumulation equations are:

$$K_{t+1} = I_t + (1 - \delta)K_t.$$

$$K_{t+2} = I_{t+1} + (1 - \delta)K_{t+1}.$$

The firm liquidates itself (i.e. sells off the remaining capital that has not depreciated during the period) at the end of the second period. The firm borrows to finance any investment in period t at r_t . The firm's objective is to maximize its value, given by:

$$V = D_t + \frac{D_{t+1}}{1 + r_t}$$

where Π_t denotes profits, which are paid as dividends to its owners, and the firm takes the interest rate as given.

- (a) Write down the expressions for both current and future profits, D_t and D_{t+1} . What is the terminal condition on K_{t+2} ?
- (b) Write down the firm's optimization problem. What are its choice variables?
- (c) Algebraically solve for the firm's optimal choice of investment, I_t .
- (d) Now suppose that there is a proportional tax rate (i.e. not a lump sum tax) on firm profits, τ_t , which is the same in both periods (i.e. $\tau_t = \tau_{t+1}$). Re-do the above, solving for the optimal investment rule. What is the effect of the tax rate on investment?
- (e) Instead, suppose that the tax rate is on revenue, not profits. That is, after tax firm profits in the first period are now $(1 - \tau_t)Y_t - I_t$ instead of $(1 - \tau_t)(Y_t - I_t)$. In the second period output is again taxed, but the liquidated capital stock is not. In other words, after tax profits in the second period are: $(1 - \tau_{t+1})Y_{t+1} - I_{t+1}$. Redo the problem. What is the

effect of the tax rate on investment? How does your answer compare with your answer in Part d?

Chapter 14

Money

Up until this point, we have completely ignored money. Isn't economics all about money? In this chapter, we will define what economists mean by money and will incorporate it into our micro-founded model of the macroeconomy.

14.1 What is Money?

Defining what money is (or is not) is not such an easy task. Generically, money is an asset that can be used in exchange for goods and services. For most things, we define them according to intrinsic characteristics of those things. For example, apples are round and red. This is not really so with money. Physical currency (i.e. the dollar bills in your wallet) can be used in exchange for goods and services, as can the electronic entries in your checking account through the process of writing checks or using a debit card. Both currency and checking accounts are money in the sense that they can be used in exchange, but intrinsically they are very different things. When defining what is (and is not) money, we think about the *functions* played by money. These functions are:

1. It serves as a medium of exchange. This means that, rather than engaging in barter, one can trade money for goods and services.
2. It serves as a store of value. This means that money preserves at least some of its value across time, and is therefore a means by which a household can transfer resources across time. The store of value function of money means that money can serve a function like bonds – a way to shift resources across time.
3. It serves as a unit of account. This simplifies economic decision-making, as we denominate the value of goods and services in terms of units of money. This makes it easy to compare value across different types of goods. Suppose that an economy produces three goods – trucks, beer, and guns. Suppose a truck costs 10,000 units of money, a beer 1 unit of money, and a gun 10 units of money. We could equivalently say that a truck costs 10,000 cans of beer or 1000 guns, but there are other ways to compare value.

For example, we might say that a beer costs 0.0001 trucks or 0.1 guns. By serving as the unit of account, money serves as the numeraire, or the thing which we price all other goods according to.

Many different kinds of assets can serve these purposes. Being an asset implies that something is a store of value. Whether or not an asset is a good medium of exchange is a different story. We refer to an asset's *liquidity* as measuring how easy it is to use it in exchange. Currency is the most liquid asset – it is *the* medium of exchange. A house is not as liquid. You could in principle sell the house to raise cash and use that cash to buy some other good or service, but doing so quickly and at a fair price may not be easy. Checking accounts, or what are often called demand deposits, are virtually equivalent to currency, because you are allowed to exchange checking accounts for currency *on demand*. Because of this, in practice most measures of the money supply (see later sections of the book) count the value of checking accounts as money.

In principle, almost anything could serve the aforementioned three functions, and hence almost anything could serve as money. In fact, in the past, many different things have in fact served as money. For many years commodities served as money – things like cows, cigarettes, and precious metals (e.g. gold and silver). In more recent times, most economies have moved toward fiat money. Fiat money consists of pieces of paper (or electronic entries on a computer) which have no intrinsic value – they just have value because a government declares that they will serve as money, and they therefore have value to the extent to which they are accepted in exchange for goods and services.

It is not hard to see why commodity-based money can become problematic. First, commodities have value independent from their role as money. Fluctuating commodity prices (say there is a drought which kills off cows, increasing the value of cows, or a new discovery of gold, which decreases the market value of gold) will generate fluctuations in the price of all other goods, which can create confusion. This makes commodities which have value independent of their role in exchange problematic as a unit of account. Second, commodities may not store well, and hence may not be good stores of value. Third, commodities may not be easily divisible or transferable, and hence may not be very desirable as a medium of exchange. In the example listed above, it would not be easy to cut a cow up into 10,000 pieces in order to purchase a can of beer. Fiat money lacks these potential problems associated with commodity-based money. That being said, fiat money is prone to problems. Fiat money only has value because a government declares that it has value and people believe it. If people quit believing that money has value (i.e. quit accepting it in exchange), then the money would cease to have value. This makes fiat money quite precarious. Second, fiat money is subject to manipulation by governments – if fiat money has no intrinsic value, a government could

simply create more of that fiat money for example to pay off debts, which would decrease the value of that fiat money and implicitly serve as a tax of the holders of that money.

Most economists would agree that the medium of exchange role of money is the most important function played by money. In the real world, there are many potential stores of value – things like houses, stocks, bonds, etc. – so money is not really unique as a store of value. While it is convenient to adopt money as the numeraire, it would not be particularly problem to define some other good as the unit of account. Hence, in terms of a unit of account, nothing is all that unique about money. The crucial role that money serves is as a medium of exchange. Without money, we'd have to engage in barter, and this would be costly. For example, the professor teaching this course is providing educational services, and you (or your parents) are indirectly compensating that professor with your tuition money. Suppose there were no money, and we had to engage in barter instead. Suppose that your mother is a criminal defense attorney. To compensate the professor for educational services, she would like to trade criminal defense services in exchange for classroom instruction. But what if (hopefully) the professor is not currently in need of criminal defense? We refer to the potential mismatch between the resources a buyer of some good has available (in this case, criminal defense services) with the resources a seller has available (in this case, educational services) the double coincidence of wants problem. To successfully engage in barter, the buyer has to have something that the seller wants. With money, this is not so. The buyer can instead pay in money (e.g. money income from criminal services), and the seller can use that money to buy whatever he or she desires (e.g. a new house).

The existence of money, by eliminating the double coincidence of wants problem, facilitates more trade (not trade in an international sense, but trade in the form of exchange of different goods and services), which in turn leads to more specialization. Increased specialization results in productivity gains that ultimately make everyone better off. It is no exaggeration to say that well-functioning medium of exchange is the most important thing to have developed in economic history, and it is difficult to downplay the importance of money in a modern economy.

We have not studied money to this point because, as long as it exists and functions well, it should not matter too much. Money really only becomes interesting if it does not work well or if there is some other friction with which it interacts. In this Chapter, we will study how to incorporate money into a micro-founded equilibrium model of the business cycle. We defer a discussion of how the quantity of money is measured, or how it interacts with the rest of the economy, until Chapter 20.

14.2 Modeling Money in our Production Economy

It is not easy to incorporate money in a compelling way into the micro-founded equilibrium model of a production economy with which we have been working. Why is this? In our model, there is one representative household, one representative firm, and one kind of good (which one might think of as fruit). Because there is only one type of good and one type of household, exchange is pretty straightforward. Put a little differently, there is no double coincidence of wants problem for money to solve if there is only one kind of good in the economy. This means that the medium of exchange function of money, which in the real world is the most important role money plays, is not important in our model. With only one type of good in the economy, there is also not much compelling reason to use money as the numeraire – it is just as easy to price things in terms of units of goods (i.e. the real wage is five units of output per unit of time worked) as in money (i.e. the nominal wage is ten units of money per unit of time worked). One can use money as the unit of account in the model, but there is nothing special about it. What about money's role as a store of value? One can introduce money into the model in this way, but there are competing stores of value – the household has access to bonds, and the firm can transfer resources across time through investment in new physical capital.

We will introduce money into our model essentially as a store of value. Since things can be priced in terms of money, it also serves the unit of account role. With only one kind of good, there is no important medium of exchange role. Effectively, money is going to be an asset with which the household can transfer resources across time. In the revised version of the model, the household will be able to save through bonds (which pay interest) or money (which does not). If it helps to fix ideas, one can think of saving through bonds as putting money “in the bank,” in exchange for the principal plus interest back in the future, whereas saving through money is stuffing cash under one's mattress. If one puts a hundred dollars under one's mattress, one will have a hundred dollars when one wakes up the next period.

It is easy to see that it will be difficult to get a household to actually want to hold money in this setup. Why? Because money is dominated as a store of value to the extent to which bonds pay positive interest. If one could put a hundred dollars in the bank and get back one hundred and five dollars next period (so a five percent interest rate), why would one choose to put a hundred dollars under the mattress, when this will yield one hundred dollars in the future? What is the benefit of holding money?

To introduce a benefit of holding money, we will take a shortcut. In particular, we will assume that the household receives utility from holding money. To be specific, we will assume that the household receives utility from the quantity of real money balances which

the household holds, which is the number of goods a given stock of money could purchase. This shortcut can be motivated as a cheap way to model the beneficial aspect of money as a medium of exchange. The basic idea is as follows. The more purchasing power the money one holds has, the lower will be utility costs associated with exchange. This results in higher overall utility.

In the subsections below, we introduce money into our model and define a few important concepts. We conclude with a complete set of equilibrium decision rules, most of which look identical to what we previously encountered in Chapters 12 and 13. The new equations will be a money demand curve and an expression which relates the real interest rate to the nominal interest rate.

14.2.1 Household

Let us begin with a discussion of how the introduction of money as a store of value impacts the household's budget constraint. First, some notation. Let M_t denote the quantity of money that the household chooses to hold. This quantity of money is taken between period t and $t + 1$, in an analogous way to savings, S_t (i.e. it is a *stock*). Let P_t denote the price of goods measured in units of money (e.g. P_t would be two dollars per good). Let i_t be the nominal interest rate. If one puts one dollar in the bank in period t , one gets $1 + i_t$ dollars back in period $t + 1$. As we discussed in Chapter 1, real variables are measured in quantities of goods, whereas nominal variables are measured in units of money.

Let C_t be the number of units of consumption (this is “real” in the sense that it is denominated in units of goods). Let S_t be the number of units of goods that one chooses to save via bonds (this is again real in the sense that it is denominated in units of goods). w_t is the real wage (number of goods one gets in exchange for one unit of labor, N_t), T_t is the number of goods one has to pay to the government in the form of taxes, and D_t is the number of units of goods which the household receives in the form of a dividend from its ownership in the firm. All of these real quantities can be converted to nominal quantities by multiplying by P_t . So, for example, if $P_t = 2$ and $C_t = 2$, then the dollar value of consumption is 4.

The period t flow budget constraint for the household is given in (14.1):

$$P_t C_t + P_t S_t + M_t \leq P_t w_t N_t - P_t T_t + P_t D_t \quad (14.1)$$

(14.1) says that the dollar value of consumption, $P_t C_t$, plus the dollar value of saving in bonds, $P_t S_t$, plus the dollar value of saving in money, M_t , cannot exceed the dollar value of net income. Net income is the dollar value of labor income, $P_t w_t N_t$, less the dollar value of

tax obligations, $P_t T_t$, plus the dollar value of dividends received, $P_t D_t$.

The period $t + 1$ budget constraint is given in (14.2):

$$P_{t+1} C_{t+1} \leq P_{t+1} w_{t+1} N_{t+1} - P_{t+1} T_{t+1} + (1 + i_t) P_t S_t + P_{t+1} D_{t+1} + P_{t+1} D_{t+1}^I + M_t \quad (14.2)$$

(14.2) says that dollar value of period $t + 1$ consumption, $P_{t+1} C_{t+1}$, cannot exceed the dollar value of net income, $P_{t+1} w_{t+1} N_{t+1} - P_{t+1} T_{t+1}$, plus the dollar value of dividends received, $P_{t+1} D_{t+1} + P_{t+1} D_{t+1}^I$, plus return on saving from bonds, which is $(1 + i_t) P_t S_t$ (one puts $P_t S_t$ dollars in the bank in period t , and gets back principal plus interest), plus the money one saved in period t , which is simply M_t . When looking at (14.1) and (14.2), it is important to note that $P_t S_t$ (the dollar value of saving in bonds) and M_t (the dollar value of saving in money) enter the budget constraints in exactly the same way. The only difference is that bonds pay interest, i_t , whereas the effective interest rate on money is zero. In writing the second period constraint, we have gone ahead and imposed the terminal conditions that the household not die with any positive or negative savings (i.e. $S_{t+1} = 0$) and that the household not carry any money over into period $t + 2$ (i.e. $M_{t+1} = 0$), since the household does not exist in period $t + 2$.

Let's re-write these budget constraints in real terms. Start by dividing (14.1) by P_t . Simplifying yields:

$$C_t + S_t + \frac{M_t}{P_t} \leq w_t N_t - T_t + D_t \quad (14.3)$$

For the period $t + 1$ budget constraint, divide both sides of (14.2) by P_{t+1} . One gets:

$$C_{t+1} \leq w_{t+1} N_{t+1} - T_{t+1} + (1 + i_t) \frac{P_t}{P_{t+1}} S_t + D_{t+1} + D_{t+1}^I + \frac{M_t}{P_{t+1}} \quad (14.4)$$

Both the period t and $t + 1$ budget constraints are now expressed in real terms – the units of all entries are units of goods, not units of money. The period t constraint says that the household has real income from labor and distributed dividends, and pays taxes to a government. With this income, the household can consume, C_t , save in bonds, S_t , or save via money, $\frac{M_t}{P_t}$. The term $\frac{M_t}{P_t}$ is referred to as real money balances (or real balances for short). $\frac{M_t}{P_t}$ equals the number of goods that the stock of money could purchase. For example, if $M_t = 10$ and $P_t = 2$, then the 10 units of money could purchase $10/2 = 5$ units of goods. In period $t + 1$ the household has income from labor, income from its ownership of the firm, income from ownership of the financial intermediary, interest income from its saving in bonds, and the real purchasing power of the money it brought between t and $t + 1$, equal to $\frac{M_t}{P_{t+1}}$. To be

concrete, the household brings M_t units of money into $t + 1$, which is the equivalent of $\frac{M_t}{P_{t+1}}$ units of goods in period $t + 1$.

In the period $t + 1$ constraint written in real terms, the term $(1 + i_t)\frac{P_t}{P_{t+1}}$ multiplies the term S_t . $(1 + i_t)\frac{P_t}{P_{t+1}}$ represents the (gross) real return on saving through bonds. As such we will define:

$$1 + r_t = (1 + i_t)\frac{P_t}{P_{t+1}} \quad (14.5)$$

The expression in (14.5) is known as the Fisher relationship, after famous economist Irving Fisher. It relates the real interest rate, r_t (which we have already encountered), to the nominal interest. The gross nominal interest rate is multiplied by $\frac{P_t}{P_{t+1}}$. Suppose that you put want to put one unit of goods into a saving bond in period t . This requires putting P_t units of money into the bond. This will generate $(1 + i_t)P_t$ units of money in period $t + 1$. This will purchase $(1 + i_t)\frac{P_t}{P_{t+1}}$ goods in period $t + 1$. Define $1 + \pi_{t+1}^e = \frac{P_{t+1}}{P_t}$ as the expected gross inflation rate between periods t and $t + 1$.¹ This means that the Fisher relationship can equivalently be written:

$$1 + r_t = \frac{1 + i_t}{1 + \pi_{t+1}^e} \quad (14.6)$$

Taking logs of (14.6) and using the approximation that the log of one plus a small number is the small number, the Fisher relationship can be approximated:

$$r_t = i_t - \pi_{t+1}^e \quad (14.7)$$

Using the Fisher relationship, the period $t + 1$ budget constraint in real terms, (14.4) can equivalently be written:

$$C_{t+1} \leq w_{t+1}N_{t+1} - T_{t+1} + (1 + r_t)S_t + D_{t+1} + D_{t+1}^I + \frac{1 + r_t}{1 + i_t} \frac{M_t}{P_t} \quad (14.8)$$

Looking at (14.3) and (14.8), one sees that these are identical budget constraints to what we encountered Chapter 13, with the only addition that the $\frac{M_t}{P_t}$ term shows up in both the constraints. Let's assume that (14.8) holds with equality. Solve for S_t from (14.8):

¹Here and for most of the remainder of the book, we will take expected inflation to be exogenous. A thorny issue here concerns the equilibrium determination of P_{t+1} . As we will later see, P_t will be determined in equilibrium given M_t . But since the household would not want to hold any M_{t+1} (i.e. money to take from $t + 1$ to $t + 2$), since the household ceases to exist after period $t + 1$, money will not have any value in period $t + 1$ and $P_{t+1} = 0$. This is a generic problem with finite horizon models where money enters the utility function. We will ignore this, appealing to the fact that we are treating the two period model as an approximation to a multi-period model, and treat expected future inflation as exogenous.

$$S_t = \frac{C_{t+1}}{1+r_t} - \frac{w_{t+1}N_{t+1} - T_{t+1} + D_{t+1} + D_{t+1}^I}{1+r_t} - \frac{1}{1+i_t} \frac{M_t}{P_t} \quad (14.9)$$

Now plug (14.9) into (14.3), assuming that it holds with equality. Doing so and simplifying yields:

$$C_t + \frac{C_{t+1}}{1+r_t} = w_t N_t - T_t + D_t + \frac{w_{t+1}N_{t+1} - T_{t+1} + D_{t+1} + D_{t+1}^I}{1+r_t} - \frac{i_t}{1+i_t} \frac{M_t}{P_t} \quad (14.10)$$

This is the intertemporal budget constraint for the household. It is identical to the real intertemporal budget constraint we encountered previously, with the addition of the term $-\frac{i_t}{1+i_t} \frac{M_t}{P_t}$ appearing on the right hand side.

As noted earlier, we assume that the household receives utility from holding money, in particular the real purchasing power of money, $\frac{M_t}{P_t}$. A slight complication is that the way in which we have written the problem, money is held “across” periods (i.e. between t and $t+1$), so it is not obvious whether the household should receive utility from holding money in period t or period $t+1$. We will assume that this utility flow accrues in period t and that the utility flow from holdings of real money balances is additively separable from utility from consumption and leisure. Lifetime utility for the household is given by:

$$U = u(C_t, 1 - N_t) + v\left(\frac{M_t}{P_t}\right) + \beta u(C_{t+1}, 1 - N_{t+1}) \quad (14.11)$$

Here, $v(\cdot)$ is a function which is increasing and concave which maps real money balances into utils. An example function is the natural log. The objective of the household will be to pick C_t , C_{t+1} , N_t , N_{t+1} , and now also M_t to maximize U , subject to the intertemporal budget constraint, (14.10). The household is a price taker and treats r_t , w_t , i_t , and P_t and P_{t+1} (equivalently π_{t+1}^e) as given. Formally, the problem of the household is:

$$\max_{C_t, C_{t+1}, N_t, N_{t+1}, M_t} U = u(C_t, 1 - N_t) + v\left(\frac{M_t}{P_t}\right) + \beta u(C_{t+1}, 1 - N_{t+1}) \quad (14.12)$$

s.t.

$$C_t + \frac{C_{t+1}}{1+r_t} = w_t N_t - T_t + D_t + \frac{w_{t+1}N_{t+1} - T_{t+1} + D_{t+1} + D_{t+1}^I}{1+r_t} - \frac{i_t}{1+i_t} \frac{M_t}{P_t} \quad (14.13)$$

To find the optimality conditions, solve for one of the choice variables in (14.13). We will solve for C_{t+1} . We get:

$$C_{t+1} = (1+r_t) [w_t N_t - T_t + D_t - C_t] + w_{t+1} N_{t+1} - T_{t+1} + D_{t+1} + D_{t+1}^I - (1+r_t) \frac{i_t}{1+i_t} \frac{M_t}{P_t} \quad (14.14)$$

Now plug this into the objective function, which transforms the problem into an unconstrained one:

$$\begin{aligned} \max_{C_t, N_t, N_{t+1}, M_t} \quad & U = u(C_t, 1 - N_t) + v\left(\frac{M_t}{P_t}\right) + \dots \\ \dots \beta u\left(\left(1 + r_t\right) [w_t N_t - T_t + D_t - C_t] + w_{t+1} N_{t+1} - T_{t+1} + D_{t+1} + D_{t+1}^I + (1 + r_t) \frac{i_t}{1 + i_t} \frac{M_t}{P_t}, 1 - N_{t+1}\right) \end{aligned} \quad (14.15)$$

Take the derivatives of lifetime utility with respect to the choice variables. In doing so, we make use of the chain rule, but abbreviate the argument in the second period utility function as C_{t+1} (the expression for which is given in (14.14)).

$$\frac{\partial U}{\partial C_t} = u_C(C_t, 1 - N_t) - \beta u_C(C_{t+1}, 1 - N_{t+1})(1 + r_t) = 0 \quad (14.16)$$

$$\frac{\partial U}{\partial N_t} = -u_L(C_t, 1 - N_t) + \beta u_C(C_{t+1}, 1 - N_{t+1})(1 + r_t)w_t = 0 \quad (14.17)$$

$$\frac{\partial U}{\partial N_{t+1}} = -u_L(C_{t+1}, 1 - N_{t+1}) + u_C(C_{t+1}, 1 - N_{t+1})w_{t+1} = 0 \quad (14.18)$$

$$\frac{\partial U}{\partial M_t} = v'\left(\frac{M_t}{P_t}\right) \frac{1}{P_t} - \beta u_C(C_{t+1}, 1 - N_{t+1})(1 + r_t) \frac{i_t}{1 + i_t} \frac{1}{P_t} = 0 \quad (14.19)$$

The first three equations can be re-arranged to yield:

$$u_C(C_t, 1 - N_t) = \beta(1 + r_t)u_C(C_{t+1}, 1 - N_{t+1}) \quad (14.20)$$

$$u_L(C_t, 1 - N_t) = u_C(C_t, 1 - N_t)w_t \quad (14.21)$$

$$u_L(C_{t+1}, 1 - N_{t+1}) = u_C(C_{t+1}, 1 - N_{t+1})w_{t+1} \quad (14.22)$$

These are exactly the same first order conditions we derived in Chapter 12 for the choices of consumption and labor. Each of these has the familiar “marginal benefit = marginal cost” interpretation. The new first order conditions relates to the choice of how much money to hold across periods. We can re-write (14.19) as:

$$v'\left(\frac{M_t}{P_t}\right) = \frac{i_t}{1 + i_t} u_C(C_t, 1 - N_t) \quad (14.23)$$

This condition also has the interpretation of “marginal benefit = marginal cost,” though it takes a bit of work to see this. The left hand side is the marginal benefit of holding an

additional unit of real money balances. This is the marginal utility of holding more money. What is the marginal cost of holding money? This is an opportunity cost. In the model, there are two savings vehicles – money and bonds, with the difference being that bonds pay interest, whereas money does not. If a household saves an additional unit of goods in money (i.e. chooses to hold an additional unit of real money balances), it is foregoing saving one unit in bonds. Saving one unit of goods in bonds would entail saving P_t units of money, which would yield $(1 + i_t)P_t$ additional units of money in period $t + 1$. Saving one unit of goods in money entails saving P_t dollars, which yields P_t dollars in period $t + 1$. You can think about money and bonds as being identical, except bonds pay i_t whereas the interest rate on money is 0. The opportunity cost of saving in money is the difference between how much money you'd have in $t + 1$ from saving in bonds versus saving via money, or $i_t P_t$. This additional money in period $t + 1$ will purchase $\frac{i_t P_t}{P_{t+1}}$ goods in period $t + 1$, which increases lifetime utility by the discounted marginal utility of future consumption, or $\beta u_C(C_{t+1}, 1 - N_{t+1}) \frac{i_t P_t}{P_{t+1}}$. Combining the Euler equation with the Fisher relationship, one can write $u_C(C_{t+1}, 1 - N_{t+1}) = \frac{1}{\beta} \frac{1}{1+i_t} \frac{P_{t+1}}{P_t} u_C(C_t, 1 - N_t)$. Substituting this in yields the marginal cost of holding money as $\frac{i_t}{1+i_t} u_C(C_t, 1 - N_t)$. Hence, (14.23) has the familiar marginal benefit = marginal cost interpretation. At an optimum, a household will hold money up until the point where the marginal benefit of doing so equals the marginal cost.

Before proceeding, it is useful to conclude our analysis with a discussion of why it is important to assume that the household receives utility from holding money. Suppose that $v'(\cdot) = 0$. This would mean that holding more (or fewer) real balances would not affect a household's lifetime utility. If this were the case, (14.23) could not hold, unless $i_t = 0$. If $i_t > 0$, then the marginal cost of holding money would always be positive, whereas the marginal benefit of holding money would be zero. Put slightly differently, since bonds pay interest whereas money does not, if there is no marginal benefit from money and the interest rate is positive, the household would choose to hold no money (i.e. we would be at a corner solution). If $i_t = 0$, then bonds and money would be perfect substitutes, and the household would be indifferent between saving through bonds or saving through money. Hence, for the more general case in which the nominal interest rate is positive, to get the household to be willing to hold money we must have there be some benefit of doing so, which we have built in to the model via real balances in the lifetime utility function.

The first two optimality conditions, (14.20) and (14.22), are identical to what we had before, and as such imply the same consumption and labor supply functions:

$$C_t = C^d(Y_t - T_t, Y_{t+1} - T_{t+1}, r_t) \quad (14.24)$$

$$N_t = N^s(w_t, \theta_t) \quad (14.25)$$

In (14.24) consumption demand is increasing in current and future net income and decreasing in the real interest rate (via the assumption that the substitution effect of changes in the real interest rate dominates the income effect). In (14.25), labor supply is increasing in the real wage and decreasing in θ_t , which we take to be an exogenous labor supply shifter.

We can use (14.23) to think about how changes in different variables impact the desired quantity of M_t a household would like to hold. First, we can see that the demand for M_t is proportional to P_t . If P_t goes up, this does not impact the amount of $\frac{M_t}{P_t}$ the household would like to hold, and hence M_t is increasing in P_t . This is fairly intuitive – the more goods cost in terms of money, the more money a household would like to hold. Second, note that a higher i_t makes $\frac{i_t}{1+i_t}$ bigger. This means that the household needs to adjust its money holdings so as to make $v'(\frac{M_t}{P_t})$ bigger. Since we assume $v''(\cdot) < 0$, this requires reducing M_t . This is again fairly intuitive. The nominal interest rate represents the opportunity cost of holding money – the higher is i_t , the less money a household would like to hold. Finally, suppose that the household increases its consumption. This would make $u_C(\cdot)$ decrease, which means that the household needs to adjust M_t in such a way as to generate a decrease in $v'(\frac{M_t}{P_t})$. Again, since we have assumed that $v(\cdot)$ is a concave function, this would entail increasing M_t . Hence, M_t is increasing in consumption. This again is fairly intuitive – the more stuff a household is buying, the more money it is going to want to hold. Hence, we conclude that money demand ought to be increasing in P_t , decreasing in i_t , and increasing in consumption, C_t .

Based on this qualitative analysis of the FOC for money, we will write a money demand function as follows:

$$M_t = P_t M^d \underset{-}{i_t}, \underset{+}{Y_t} \quad (14.26)$$

In writing (14.26), we have written money demand as a function of Y_t rather than C_t . Since C_t depends on Y_t , this is not such a bad simplification. We are, however, abstracting from things other than Y_t which would impact C_t , and hence money demand. We make this abstraction for simplicity and to facilitate comparison with money demand specifications used in empirical work, which typically are specified as depending on Y_t , rather than C_t . Money demand is decreasing in the nominal interest rate and increasing in income. It is proportional (and hence increasing) in P_t .

Money demand depends on the nominal interest rate (whereas consumption demand depends on the real interest rate). We can, however, specify money demand in terms of the real interest rate using the approximate version of the Fisher relationship, where $i_t = r_t + \pi_{t+1}^e$.

To the extent to which expected inflation is close to constant, the real and nominal interest rates will move together:

$$M_t = P_t M^d(r_t + \pi_{t+1}^e, Y_t) \quad (14.27)$$

Example

Suppose that we have an endowment economy in which labor is fixed. Suppose that lifetime utility is given by:

$$U = \ln C_t + \psi_t \ln \left(\frac{M_t}{P_t} \right) \quad (14.28)$$

Then the first order optimality conditions work out to:

$$\frac{1}{C_t} = \beta(1 + r_t) \frac{1}{C_{t+1}} \quad (14.29)$$

$$\psi_t \frac{P_t}{M_t} = \frac{i_t}{1 + i_t} \frac{1}{C_t} \quad (14.30)$$

(14.30) can be re-arranged to yield:

$$M_t = P_t \psi_t \frac{1 + i_t}{i_t} C_t \quad (14.31)$$

In (14.31), desired M_t is increasing in P_t , decreasing in i_t , and increasing in C_t .

14.2.2 Firm

In our model, the firm does not use money as a means to transfer resources across time. In other words, the firm does not hold money. As such, its problem is identical to what we previously encountered. The problem can be written in nominal or real terms. Using the Fisher relationship, the first order conditions for the firm's problem are exactly the same as we had previously encountered. These are repeated below for convenience.

$$w_t = A_t F_N(K_t, N_t) \quad (14.32)$$

$$w_{t+1} = A_{t+1} F_N(K_{t+1}, N_{t+1}) \quad (14.33)$$

$$1 + r_t = A_{t+1} F_K(K_{t+1}, N_{t+1}) + (1 - \delta) \quad (14.34)$$

These first order conditions implicitly define labor and investment demand functions of the sort (where underscores denote the sign of the partial derivatives):

$$N_t = N^d(w_t, A_t, K_t) \quad (14.35)$$

$$I_t = I^d(r_t, A_{t+1}, K_t) \quad (14.36)$$

14.2.3 Government

The third actor in our model economy is the government. As in Chapter 13, this government chooses an exogenous amount of spending each period, G_t and G_{t+1} . It uses lump sum taxes levied on the household, T_t and T_{t+1} , to finance this expenditure. In addition to its fiscal responsibility, we assume that the government can set the money supply. One can think about this as “printing” money, though in reality most money these days is simply electronic. The amount of money supplied by the government is assumed to be exogenous, $M_t^s = M_t$.

There is no cost of the government of “printing” money. Hence, “printing” money is essentially a form of revenue for a government. This form of revenue is referred to as seignorage. The government’s period t and $t + 1$ budget constraints, expressed in nominal terms, are:

$$P_t G_t \leq P_t T_t + P_t B_t + M_t \quad (14.37)$$

$$P_{t+1} G_{t+1} + (1 + i_t) P_t B_t + M_t \leq P_{t+1} T_{t+1} \quad (14.38)$$

In (14.37), B_t is the amount of real debt issued by the government; multiplication by P_t puts it in nominal terms. As one can see, the inclusion of M_t on the right hand side means that M_t is a source of nominal revenue for the government. We have imposed that the government not issue any debt in period $t + 1$ (i.e. $B_{t+1} = 0$) and also that it not issue any money in period $t + 1$ (i.e. $M_{t+1} = 0$). In the second period, the government can purchase goods (expenditure of $P_{t+1} G_{t+1}$) but must pay off its debt. It brings $P_t B_t$ dollars of debt into period $t + 1$, and pays back the principal plus nominal interest, so $(1 + i_t) P_t B_t$ is its nominal interest expense in period $t + 1$. In addition, we can think about the government “buying back” the money it printed in period t , so M_t is an expense for the government in period t . One can think about the government creating money and selling it in period t , and then buying it back (or “retiring it”) in period $t + 1$. It raises nominal revenue $P_{t+1} T_{t+1}$.

Each of these constraints can be written in real terms by dividing each budget constraint by the price level in that period:

$$G_t \leq T_t + B_t + \frac{M_t}{P_t} \quad (14.39)$$

$$G_{t+1} + (1+i_t) \frac{P_t}{P_{t+1}} B_t + \frac{M_t}{P_{t+1}} \leq T_{t+1} \quad (14.40)$$

(14.39) is the same real budget constraint we encountered for the government in Chapter 13, but $\frac{M_t}{P_t}$ appears on the right hand side as real seignorage revenue. Since $(1+i_t) \frac{P_t}{P_{t+1}} = (1+r_t)$, (14.40) is the same as we encountered previously, but $\frac{M_t}{P_{t+1}}$ appears on the left hand side.

We can combine these constraints into an intertemporal budget constraint for the government. Solve for B_t in the period $t+1$ constraint:

$$B_t = \frac{T_{t+1} - G_{t+1}}{1+r_t} - \frac{1}{1+r_t} \frac{M_t}{P_{t+1}} \quad (14.41)$$

Plugging this in to (14.39), we get:

$$G_t + \frac{G_{t+1}}{1+r_t} = T_t + \frac{T_{t+1}}{1+r_t} + \frac{M_t}{P_t} - \frac{1}{1+r_t} \frac{M_t}{P_{t+1}} \quad (14.42)$$

Since $\frac{1}{1+r_t} = \frac{1}{1+i_t} \frac{P_{t+1}}{P_t}$, the term involving money can be re-written, yielding:

$$G_t + \frac{G_{t+1}}{1+r_t} = T_t + \frac{T_{t+1}}{1+r_t} + \frac{i_t}{1+i_t} \frac{M_t}{P_t} \quad (14.43)$$

(14.43) is the government's intertemporal budget constraint, and is analogous to the household's intertemporal budget constraint, (14.10). The real present discounted value of government spending (consumption for the household) must equal the real present discounted value of revenue (income for the household), plus a term related to real balances for each. This term is the same for both the government and household, $\frac{i_t}{1+i_t} \frac{M_t}{P_t}$, though it enters with a positive sign in the government's IBC and a negative sign in the household's IBC.

14.2.4 Equilibrium

The equilibrium is a set of prices and allocations for which all agents are behaving optimally and all markets simultaneously clear. Household optimization requires that the consumption and labor supply functions, (14.24) and (14.25) hold. Firm optimization requires that the labor demand and investment demand functions, (14.35) and (14.36), both hold. There is an additional optimality condition related to the household's demand for money, given by (14.26). The Fisher relationship, written in its approximate form, (14.7), relates the nominal and real interest rates with the rate of expected inflation, which we take as

exogenous to the model.

Market-clearing requires that all budget constraints hold with equality. In real terms, the household's period t budget constraint is:

$$C_t + S_t + \frac{M_t}{P_t} \leq w_t N_t - T_t + D_t \quad (14.44)$$

Market-clearing in the market for bonds requires that:

$$S_t - B_t = I_t \quad (14.45)$$

Real firm profit is:

$$D_t = Y_t - w_t N_t \quad (14.46)$$

Combining these yields:

$$C_t + I_t + B_t + \frac{M_t}{P_t} = Y_t - T_t \quad (14.47)$$

From the government's period t budget constraint, we have:

$$T_t = G_t - B_t - \frac{M_t}{P_t} \quad (14.48)$$

Combining (14.48) with (14.47), we have:

$$Y_t = C_t + I_t + G_t \quad (14.49)$$

This is a standard aggregate resource constraint. Note that money does not appear.

Recall the household's intertemporal budget constraint, repeated here for convenience:

$$C_t + \frac{C_{t+1}}{1+r_t} = w_t N_t - T_t + D_t + \frac{w_{t+1} N_{t+1} - T_{t+1} + D_{t+1} + D_{t+1}^I}{1+r_t} - \frac{i_t}{1+i_t} \frac{M_t}{P_t} \quad (14.50)$$

Because taxes are lump sum, this can equivalently be written:

$$C_t + \frac{C_{t+1}}{1+r_t} = w_t N_t + D_t + \frac{w_{t+1} N_{t+1} + D_{t+1} + D_{t+1}^I}{1+r_t} - \left(T_t + \frac{T_{t+1}}{1+r_t} \right) - \frac{i_t}{1+i_t} \frac{M_t}{P_t} \quad (14.51)$$

From the government's intertemporal budget constraint, (14.43), we have:

$$T_t + \frac{T_{t+1}}{1+r_t} = G_t + \frac{G_{t+1}}{1+r_t} - \frac{i_t}{1+i_t} \frac{M_t}{P_t} \quad (14.52)$$

Combining (14.52) with (14.51), we get:

$$C_t + \frac{C_{t+1}}{1+r_t} = w_t N_t + D_t + \frac{w_{t+1} N_{t+1} + D_{t+1} + D_{t+1}^I}{1+r_t} - \left(G_t + \frac{G_{t+1}}{1+r_t} \right) \quad (14.53)$$

There are two things worth noting. First, the real balance term, $\frac{M_t}{P_t}$, drops out. Second, taxes disappear, leaving only the present discounted value of government expenditures on the right hand side. These terms can be re-arranged to yield:

$$C_t + \frac{C_{t+1}}{1+r_t} = w_t N_t - G_t + D_t + \frac{w_{t+1} N_{t+1} - G_{t+1} + D_{t+1} + D_{t+1}^I}{1+r_t} \quad (14.54)$$

Just as we saw in Chapter 13, both government and household budget constraints holding, along with taxes being lump sum (i.e. additive), means that, from the household's perspective, it is as though $T_t = G_t$. In other words, Ricardian Equivalence continues to hold – the household behaves as though the government balances its budget each period, whether the government does so or not. This means that the consumption function, (14.24), can instead be written:

$$C_t = C^d(Y_t - G_t, Y_{t+1} - G_{t+1}, r_t) \quad (14.55)$$

The full set of equilibrium conditions can be written:

$$C_t = C^d(Y_t - G_t, Y_{t+1} - G_t, r_t) \quad (14.56)$$

$$N_t = N^s(w_t, \theta_t) \quad (14.57)$$

$$N_t = N^d(w_t, A_t, K_t) \quad (14.58)$$

$$I_t = I^d(r_t, A_{t+1}, K_t) \quad (14.59)$$

$$Y_t = A_t F(K_t, N_t) \quad (14.60)$$

$$Y_t = C_t + I_t + G_t \quad (14.61)$$

$$M_t = P_t M^d(i_t, Y_t) \quad (14.62)$$

$$r_t = i_t - \pi_{t+1}^e \quad (14.63)$$

The first six of these expressions are identical to what we encountered in Chapter 13. There are two new equations – the money demand specification (14.62), and the Fisher relationship relating the real and nominal interest rates to one another, (14.63). There are eight endogenous variables – Y_t , C_t , I_t , N_t , w_t , r_t , P_t , and i_t . The first six of these are the same as we had before, with the two new endogenous nominal variables, P_t and i_t . The

exogenous variables are A_t , A_{t+1} , G_t , G_{t+1} , K_t , M_t , and π_{t+1}^e . The first six of these are the same as we previously encountered, with the addition of the two new exogenous nominal variables, M_t and π_{t+1}^e .

14.3 Summary

- Money is a store of value, unit of account, and medium exchange. The medium of exchange is the primary reason money is valuable as it allows people to avoid the double coincidence of wants problem. That is, one can exchange money for a good or service rather than bartering.
- The medium of exchange motive is difficult to model since we only have one good and a representative agent. As a shortcut, we assume the representative agent receives utility from holding real money balances.
- The Fisher relationship says that the real interest rate is approximately equal to the nominal interest rate minus expected inflation.
- A higher nominal interest rate increases the opportunity cost of holding money. Hence, money demand is decreasing in the nominal interest rate. Conversely, as income goes up, the household wants to make more exchanges which means the demand for money increases.
- The government sells money to the household in period t and buys it back in $t + 1$. The rest of government and the entire firm optimization problem are exactly the same as in previous chapters.

Key Terms

- Store of value
- Unit of account
- Medium of exchange
- Double coincidence of wants problem
- Commodity-based money
- Fiat money
- Fisher relationship

Questions for Review

1. Explain why bartering is inefficient.
2. Explain some of the problems associated with commodity-based money.
3. Can the real interest rate be negative? Why?
4. Can the nominal interest rate be negative? Why?
5. In our model, households can save through bonds or money. If households do not receive utility from holding real money balances, how much will they save in money?
6. Write down the demand function for real money balances. How is it affected by income and the nominal interest rate?
7. Derive the government's intertemporal budget constraint. How is it different than the intertemporal constraint in Chapter 13.

Exercises

1. In our basic model with money, the money demand curve is implicitly defined by:

$$\phi' \left(\frac{M_t}{P_t} \right) = \frac{i_t}{1 + i_t} u'(C_t)$$

- (a) Suppose that the functional forms are as follows: $\phi \left(\frac{M_t}{P_t} \right) = \theta \ln \frac{M_t}{P_t}$ and $u(C_t) = \ln C_t$. The parameter θ is a positive constant. Write the money demand curve using these functional forms.

The “quantity equation” is a celebrated identity in economics that says that the money supply times a term called “velocity” must equal nominal GDP:

$$M_t V_t = P_t Y_t$$

Velocity, V_t is defined as the number of times the average unit of money is used. Here's the basic idea. Suppose that nominal GDP is 100 dollars, and that the money supply is ten dollars. If money must be used for all transactions, then it must be the case that velocity equals 10: $V_t = \frac{P_t Y_t}{M_t} = \frac{100}{10}$. The quantity equation is an *identity* because it is defined to hold. We do not measure V_t in the data, but can back it out of the data given measurement on nominal GDP and the money supply.

- (b) Take your money demand expression you derived in part (a). Assume that $C_t = Y_t$. Use this expression to derive the quantity equation. In terms of the model, what must V_t equal?
- (c) What is the relationship between the nominal interest rate, i_t , and your model-implied expression for velocity, V_t (i.e. take the derivative of V_t with respect to i_t and determine whether it is positive, zero, or negative). Given the way velocity is defined conceptually (the number of times the average unit of money is used), explain why the sign of the derivative of V_t with respect to i_t does or does not make sense.
2. **[Excel Problem]** Assuming log utility, the basic consumption Euler equation can be written:

$$\frac{C_{t+1}}{C_t} = \beta(1 + r_t)$$

If we take logs of this, and use the approximation that the natural log of one plus a small number is approximately the small number, then we can write this as:

$$r_t = g_{t+1}^C - \ln \beta$$

In other words, the real interest rate ought to equal the expected growth rate of consumption minus the log of the discount factor.

- (a) For the period 1947 through 2015, download annual data on the GDP price deflator ([here](#)), annual data on real consumption growth ([here](#)), and data on the the 3-Month Treasury Bill rate ([here](#), this series is available at a higher frequency than annual, so to get it in annual terms, click “edit graph” and modify frequency to annual using the average method). The approximate real interest rate is $r_t = i_t - \pi_{t+1}^e$. Measure i_t by the 3-Month T-Bill rate and assume expected inflation equals realized inflation one period ahead (i.e. the interest rate observation in 1947 will be the 3-Month T-Bill in 1947, while you will use realized inflation in 1948 for expected inflation in 1947). Compute a series for the real interest rate. Plot this series. What is the average real interest rate? How often has it been negative? Has it been negative or positive recently?
- (b) What is the correlation between the real interest rate series you create

and expected consumption growth (i.e. compute the correlation between consumption growth in 1948:2015 and the real interest rate between 1947:2014)? Is the sign of this correlation qualitatively in line with the predictions of the Euler equation? Is this correlation strong?

3. [**Excel Problem**] In this problem, we will investigate the velocity of money in the data.

- (a) Download quarterly data on the money supply and nominal GDP. Do this for the period 1960-2015. Define the money supply as M2. You can get this from the St. Louis Fed Fred website. Simply go to the website, type “M2” into the search box, and it’ll be the first hit. You’ll want to click on “Monthly, seasonally adjusted.” Then it’ll take you to a page and you can click “Download data” in the upper left part of the screen. There will be a box on that page labeled “Frequency.” You will want to click down to go to “quarterly” using “average” as the “aggregation method” (this is the default). To get the GDP data just type “GDP” into the search box. “Gross Domestic Product” will be the first hit. You’ll want to make sure that you’re downloaded “Gross Domestic Product” *not* “Real Gross Domestic Product.” After you have downloaded these series, define log velocity as log nominal GDP minus the log money supply. Produce a plot of log velocity over time.
- (b) The so-called “Monetarists” were a group of economists who advocated using the quantity equation to think about aggregate economy policy. A central tenet of monetarism was the belief that velocity was roughly constant, and that we could therefore think about changes in the money supply as mapping one-to-one into nominal GDP. Does velocity look roughly constant in your time series graph? Are there any sub-periods where velocity looks roughly constant? What has been happening to velocity recently?
- (c) Download data on the three month treasury bill rate as a measure of the nominal interest. To get this, go to FRED and type “treasury bill” into the search box. The first hit will be the “Three Month Treasury Bill, Secondary Market Rate.” Click on the “monthly” series, and then on the next page click “Download Data.” You will again need to change

the frequency to quarterly in the relevant box as you did above. Interest rates are quoted as percentages at an annualized frequency. To make the concept consistent with what is in the model, you will need to divide the interest rate series by 400 (dividing by 4 puts it into quarterly units, as opposed to annualized, and dividing by 100 gets it out of percentage units, so you are dividing by $4 \times 100 = 400$). Now, use your model implied money demand function from part (b) to derive a model-implied time series for velocity. Use the M2 series and the nominal GDP series, along with your downloaded measure of the interest rate, to create a velocity series. Assume that the parameter $\theta = 0.005$. Produce a plot of the model-implied log velocity series. Does it look kind of like the velocity series you backed out in the data? What is the correlation between the model-implied log velocity series and the actual log velocity series you created in part (d)? Is the model roughly consistent with the data?

Chapter 15

Equilibrium Efficiency

The conditions of the equilibrium model of production which we have been developing through Part III, expressed as supply and demand decision rules, are repeated below for convenience:

$$C_t = C^d(Y_t - G_t, Y_{t+1} - G_{t+1}, r_t) \quad (15.1)$$

$$N_t = N^s(w_t, \theta_t) \quad (15.2)$$

$$N_t = N^d(w_t, A_t, K_t) \quad (15.3)$$

$$I_t = I^d(r_t, A_{t+1}, K_t) \quad (15.4)$$

$$Y_t = A_t F(K_t, N_t) \quad (15.5)$$

$$Y_t = C_t + I_t + G_t \quad (15.6)$$

$$M_t = P_t M^d(r_t + \pi_{t+1}^e, Y_t) \quad (15.7)$$

$$r_t = i_t - \pi_{t+1}^e \quad (15.8)$$

These decision rules come from first order optimality conditions from the household and firm problems. These first order conditions implicitly define the above decision rules. The first order optimality conditions for the household are given below:

$$u_C(C_t, 1 - N_t) = \beta(1 + r_t)u_C(C_{t+1}, 1 - N_{t+1}) \quad (15.9)$$

$$u_L(C_t, 1 - N_t) = u_C(C_t, 1 - N_t)w_t \quad (15.10)$$

$$v' \left(\frac{M_t}{P_t} \right) = \frac{i_t}{1 + i_t} u_C(C_t, 1 - N_t) \quad (15.11)$$

Equation (15.9) is the consumption Euler equation. It says that, when behaving optimally, the household ought to equate the current marginal utility of consumption, $u_C(C_t, 1 - N_t)$, to the discounted marginal utility of next period's consumption, $\beta u_C(C_{t+1}, 1 - N_{t+1})$, times the gross real interest rate. This first order condition, when combined with the household's budget

constraint, implicitly defines the consumption function, (15.1), which says that consumption is an increasing function of current and future perceived net income and a decreasing function of the real interest rate. (15.10) is the first order conditions for optimal labor supply, which would look the same (only with $t+1$ subscripts) in the future. This says to equate the marginal rate of substitution between leisure and consumption (the ratio of u_L/u_C) to the relative price of leisure in terms of consumption, which is the real wage. This condition implicitly defines labor supply. Labor supply is increasing in the real wage (under the assumption that the substitution effect dominates) and decreasing in an exogenous variable θ_t , which can be interpreted as a parameter of the utility function governing how much utility the household gets from leisure. (15.11) is the first order condition for money holdings, and implicitly defines the money demand function, (15.7).

The first order optimality conditions coming out of the firm's profit maximization problem are:

$$w_t = A_t F_N(K_t, N_t) \quad (15.12)$$

$$w_{t+1} = A_{t+1} F_N(K_{t+1}, N_{t+1}) \quad (15.13)$$

$$r_t + \delta = A_{t+1} F_K(K_{t+1}, N_{t+1}) \quad (15.14)$$

Expressions (15.12)-(15.13) are the firm's optimality conditions for the choice of labor. These say to hire labor up until the point at which the real wage equals the marginal product of labor. These expressions are identical for period t and $t+1$. These implicitly define the labor demand function, (15.3). Labor demand is decreasing in the real wage, increasing in current productivity, and increasing in the current capital stock. Expression (15.14) is the first order optimality condition for the choice of next period's capital stock. This implicitly defines the investment demand function, (15.4). Investment demand is decreasing in the real interest rate, increasing in future productivity, and decreasing in K_t .

In the equilibrium, the household and firm take r_t , w_t , i_t , and P_t as given – i.e. they behave as price-takers, and their decision rules are defined as functions of these prices. In equilibrium, these price adjust so that markets clear when agents are behaving according to their decision rules.

15.1 The Social Planner's Problem

In a market economy, prices adjust to equilibrate markets. Does this price adjustment bring about socially desirable outcomes? We explore this question in this section.

Let us suppose that there exists a hypothetical social planner. This social planner is

benevolent and chooses allocations to maximize the lifetime utility of the representative household, subject to the constraints that aggregate expenditure not exceed aggregate production each period. The social planner's problem is also constrained by the capital accumulation equation. The question we want to examine is the following. Would this benevolent social planner choose different allocations than the ones which emerge as the equilibrium outcome of a market economy?

The objective of the social planner is to maximize the lifetime utility of the representative household. Lifetime utility is:

$$U = u(C_t, 1 - N_t) + v\left(\frac{M_t}{P_t}\right) + \beta u(C_{t+1}, 1 - N_{t+1}) \quad (15.15)$$

The planner faces a sequence of two resource constraints. Noting that $K_{t+1} = I_t + (1 - \delta)K_t$, and that $I_{t+1} = -(1 - \delta)K_{t+1}$ to impose zero left over capital, these resource constraints can be written:

$$C_t + K_{t+1} - (1 - \delta)K_t + G_t \leq A_t F(K_t, N_t) \quad (15.16)$$

$$C_{t+1} - (1 - \delta)K_{t+1} + G_{t+1} \leq A_{t+1} F(K_{t+1}, N_{t+1}) \quad (15.17)$$

The social planner's problem consists of choosing quantities to maximize (15.15) subject to (15.16)-(15.17). Note that there are no prices in the social planner's problem (other than the presence of P_t , to which we shall return more below). The hypothetical planner directly chooses quantities, unlike the market economy which relies on prices to equilibrate markets.

We will consider a couple of different versions of the social planner's problem. In the first, we will treat M_t , G_t , and G_{t+1} as given and not things which the planner can control. In this scenario, the planner gets to choose C_t , C_{t+1} , N_t , N_{t+1} , and K_{t+1} (which in turn determines I_t), taking the money supply, the sequence of government spending, and other exogenous variables as given. Then we will do a version wherein the planner can also choose the money supply. This will permit a discussion of the optimal supply of money (at least in a model with no other frictions). Finally, we will discuss ways in which to modify the problem so that government spending is beneficial.

15.1.1 The Basic Planner's Problem

The social planner's problem, taking M_t , G_t , and G_{t+1} as given, is:

$$\begin{aligned} \max_{C_t, C_{t+1}, N_t, N_{t+1}, K_{t+1}} \quad & U = u(C_t, 1 - N_t) + v\left(\frac{M_t}{P_t}\right) + \beta u(C_{t+1}, 1 - N_{t+1}) \\ \text{s.t.} \quad & \end{aligned} \quad (15.18)$$

$$C_t + K_{t+1} - (1 - \delta)K_t + G_t \leq A_t F(K_t, N_t) \quad (15.19)$$

$$C_{t+1} - (1 - \delta)K_{t+1} + G_{t+1} \leq A_{t+1} F(K_{t+1}, N_{t+1}) \quad (15.20)$$

This is a constrained optimization problem with two constraints. Assume that each constraint holds with equality, and solve for C_t and C_{t+1} in terms of other variables in each constraint:

$$C_t = A_t F(K_t, N_t) - K_{t+1} + (1 - \delta)K_t - G_t \quad (15.21)$$

$$C_{t+1} = A_{t+1} F(K_{t+1}, N_{t+1}) + (1 - \delta)K_{t+1} - G_{t+1} \quad (15.22)$$

Now plug (15.21) and (15.22) into (15.18), turning the problem into an unconstrained one:

$$\begin{aligned} \max_{N_t, N_{t+1}, K_{t+1}} U = & u(A_t F(K_t, N_t) - K_{t+1} + (1 - \delta)K_t - G_t, 1 - N_t) + v\left(\frac{M_t}{P_t}\right) + \dots \\ & \dots + \beta u(A_{t+1} F(K_{t+1}, N_{t+1}) + (1 - \delta)K_{t+1} - G_{t+1}, 1 - N_{t+1}) \end{aligned} \quad (15.23)$$

Take the derivatives with respect to the remaining choice variables. When doing so, we will abbreviate the partial derivatives with respect to C_t and C_{t+1} using just C_t or C_{t+1} , but one must use the chain rule when taking these derivatives, in the process making use of (15.21)-(15.22).

$$\frac{\partial U}{\partial N_t} = u_C(C_t, 1 - N_t) A_t F_N(K_t, N_t) - u_L(C_t, 1 - N_t) \quad (15.24)$$

$$\frac{\partial U}{\partial N_{t+1}} = \beta u_C(C_{t+1}, 1 - N_{t+1}) A_{t+1} F_N(K_{t+1}, N_{t+1}) - \beta u_L(C_{t+1}, 1 - N_{t+1}) \quad (15.25)$$

$$\frac{\partial U}{\partial K_{t+1}} = -u_C(C_t, 1 - N_t) + \beta u_C(C_{t+1}, 1 - N_{t+1}) (A_{t+1} F_K(K_{t+1}, N_{t+1}) + (1 - \delta)) \quad (15.26)$$

Setting these derivatives equal to zero and simplifying yields:

$$u_L(C_t, 1 - N_t) = u_C(C_t, 1 - N_t) A_t F_N(K_t, N_t) \quad (15.27)$$

$$u_L(C_{t+1}, 1 - N_{t+1}) = u_C(C_{t+1}, 1 - N_{t+1}) A_{t+1} F_N(K_{t+1}, N_{t+1}) \quad (15.28)$$

$$1 = \frac{\beta u_C(C_{t+1}, 1 - N_{t+1})}{u_C(C_t, 1 - N_t)} [A_{t+1} F_K(K_{t+1}, N_{t+1}) + (1 - \delta)] \quad (15.29)$$

Expressions (15.27)-(15.29) implicitly characterize the optimal allocations of the planner's problem. How do these compare to what obtains as the outcome of the decentralized

equilibrium? To see this, combine the first order conditions for the household, (15.9)-(15.10), with the first order conditions for the firm, (15.12)-(15.14). Do this in such a way as to eliminate r_t , w_t , and w_{t+1} (i.e. solve for w_t from the firm's first order condition, and then plug that in to the household's first order condition wherever w_t shows up). Doing so yields:

$$u_L(C_t, 1 - N_t) = u_C(C_t, 1 - N_t)A_tF_N(K_t, N_t) \quad (15.30)$$

$$u_L(C_{t+1}, 1 - N_{t+1}) = u_C(C_{t+1}, 1 - N_{t+1})A_{t+1}F_N(K_{t+1}, N_{t+1}) \quad (15.31)$$

$$u_C(C_t, 1 - N_t) = \beta u_C(C_{t+1}, 1 - N_{t+1}) [A_{t+1}F_K(K_{t+1}, N_{t+1}) + (1 - \delta)] \quad (15.32)$$

This emerges because $w_t = A_tF_N(K_t, N_t)$ and $w_{t+1} = A_{t+1}F_N(K_{t+1}, N_{t+1})$ from the firm's problem, and $\frac{1}{1+r_t} = \frac{\beta u_C(C_{t+1}, 1 - N_{t+1})}{u_C(C_t, 1 - N_t)}$ from the household's problem. One ought to notice that (15.27)-(15.29) are *identical* to (15.30)-(15.32).

The fact that the optimality conditions of the benevolent planner's problem are *identical* to those of the decentralized competitive equilibrium once prices are eliminated means that a benevolent social planner can do no better than the private economy left to its own device. In a sense this is a formalization of Adam Smith's *laissez fair* idea – a private economy left to its own devices achieves a Pareto efficient allocation, by which is meant that it would not be possible to improve upon the equilibrium allocations, taking as given the scarcity embodied in the resource constraints and the exogenous variables. In modern economics this result is formalized in the **First Welfare Theorem**. The First Welfare theorem holds that, under some conditions, a competitive decentralized equilibrium is efficient (in the sense of coinciding with the solution to a benevolent planner's problem). These conditions include price-taking behavior (i.e. no monopoly), no distortionary taxation (the taxes in our model are lump sum in the sense of being independent of any actions taken by agents, whereas a distortionary tax is a tax whose value is a function of actions taken by an agent, such as a labor income tax), and perfect financial markets. These conditions are satisfied in the model with which we have been working.

The result that the First Welfare Theorem holds in our model has a very important implication. It means that there is no role for economic policy to improve upon the decentralized equilibrium. Activists policies can only make things worse. There is no justification for government policies (either monetary or fiscal). This was (and is) a controversial idea. We will discuss in more depth these implications and some critiques of these conclusions in Chapter 21.

15.1.2 Planner Gets to Choose M_t

Now, let us consider a version of the hypothetical social planner's problem in which the planner gets to choose M_t , in addition to C_t , C_{t+1} , N_t , N_{t+1} , and K_{t+1} . We continue to consider G_t and G_{t+1} as being exogenously fixed. The revised version of the problem can be written:

$$\max_{C_t, C_{t+1}, N_t, N_{t+1}, K_{t+1}, M_t} U = u(C_t, 1 - N_t) + v\left(\frac{M_t}{P_t}\right) + \beta u(C_{t+1}, 1 - N_{t+1}) \quad (15.33)$$

s.t.

$$C_t + K_{t+1} - (1 - \delta)K_t + G_t \leq A_t F(K_t, N_t) \quad (15.34)$$

$$C_{t+1} - (1 - \delta)K_{t+1} + G_{t+1} \leq A_{t+1} F(K_{t+1}, N_{t+1}) \quad (15.35)$$

This is the same as we had before, except now M_t is a choice variable. We can proceed in characterizing the optimum in the same way. Solve for C_t and C_{t+1} in the constraints and transform the problem into an unconstrained one:

$$\begin{aligned} \max_{N_t, N_{t+1}, K_{t+1}, M_t} U = & u(A_t F(K_t, N_t) - K_{t+1} + (1 - \delta)K_t - G_t, 1 - N_t) + v\left(\frac{M_t}{P_t}\right) + \dots \\ & \dots + \beta u(A_{t+1} F(K_{t+1}, N_{t+1}) + (1 - \delta)K_{t+1} - G_{t+1}, 1 - N_{t+1}) \end{aligned} \quad (15.36)$$

Because M_t enters utility in an additive way from C_t and N_t , and because it does not appear in the constraints, the first order conditions with respect to N_t , N_{t+1} , and K_{t+1} are the same as above, (15.27)-(15.29). The remaining first order condition is with respect to money. It is:

$$\frac{\partial U}{\partial M_t} = v'\left(\frac{M_t}{P_t}\right) \frac{1}{P_t} \quad (15.37)$$

Setting this derivative equal to zero implies, for a finite price level, that:

$$v'\left(\frac{M_t}{P_t}\right) = 0 \quad (15.38)$$

In other words, the social planner would like to set the marginal utility of real balances equal to zero. While this condition may look a little odd, it is just a marginal benefit equals marginal cost condition. $v'\left(\frac{M_t}{P_t}\right)$ is the marginal benefit of holding money. What is the marginal cost? From the planner's perspective, there is no marginal cost of money – money is

literally costless to “print.” This differs from the household’s perspective, where the marginal cost of money is foregone interest on bonds. To get the marginal utility of real balances to go to zero, the quantity of real balances must go to infinity. Again, in a sense this is quite intuitive. If it is costless to create real balances but they provide some benefit, why not create an infinite amount of real balances?

When we compare (15.38) with (15.11), we see that in general the planner’s solution and the equilibrium outcome will not coincide. So while the equilibrium allocations of consumption, labor, and investment will be efficient, in general there will be an inefficient amount of money in the economy. There is one special circumstance in which these solutions will coincide, however. This is when $i_t = 0$ – i.e. the nominal interest rate is zero. If $i_t = 0$, then (15.11) holding requires that $v' \left(\frac{M_t}{P_t} \right) = 0$, which then coincides with the planner’s solution.

What real world implication does this have? It suggests that if a government (or more specifically a central bank) wants to maximize household welfare, it should conduct monetary policy to be consistent with a nominal interest rate of *zero*. This kind of policy is called the “Friedman Rule” after Nobel Prize winning economist [Milton Friedman](#). Friedman’s essential argument was that a positive nominal interest rate means that the private cost of holding money exceeds the public cost of creating additional money. At an optimum, the private cost should be brought in line with the public cost, which necessitates an interest rate of zero. Since the approximate Fisher relationship is given by $r_t = i_t - \pi_{t+1}^e$, if i_t is negative and r_t is positive, it must be that expected inflation is negative. While we have taken expected inflation as given, over long periods of time one might expect the expected rate of inflation to equal average realized inflation. If the real interest rate is positive on average over long periods of time, implementation of the Friedman rule therefore requires deflation (continuous decreases in the price level).

One might ask an obvious question: if the Friedman rule is optimal, then why don’t we observe central banks implementing it? For most of the last 60 or 70 years, nominal interest rates in the US and other developed economies have been positive, as have inflation rates. Only recently have nominal interest rates gone down toward zero, and this has been considered a problem to be avoided by central bankers and other policymakers.

As we will discuss later in Part V, in particular Chapter 28, in the short run the central bank may want to adjust the money supply (and hence the nominal interest rate) to stabilize the short run economy. Doing so requires the flexibility to lower interest rates. For reasons we will discuss further in Chapter 28, nominal interest rates cannot go negative (or at least cannot go very negative). Implementation of the Friedman rule would give a central bank no “wobble room” to temporarily cut interest rates in the short run. For this reason, most central banks have decided that the Friedman rule is too strong a prescription for a modern economy.

However, one can nevertheless observe that central banks do evidently find it desirable to not veer too far from the Friedman rule. Most central banks prefer low inflation rates and low nominal interest rates; countries with very high inflation rates tend to have poor economic performance. That most central banks prefer low inflation and nominal interest rates suggest that there is some real-world logic in the Friedman rule, although in its strict form it is too strong.

15.1.3 Planner Gets to Choose G_t and G_{t+1}

Let us now take our analysis of a hypothetical social planner's problem a step further. Whereas we have heretofore taken G_t and G_{t+1} as given, let us now think about how a planner would optimally choose government expenditure.

As written, the planner's problem of choosing G_t and G_{t+1} ends up being trivial – the planner would seek out a corner solution in which $G_t = 0$ and $G_{t+1} = 0$. Why? As we have written down the model, there is no benefit from government spending. Government spending in the model is completely wasteful in the sense that higher G_t reduces C_t and I_t , without any benefit. As such, the planner would want to have $G_t = 0$.

This is obviously not a good description of reality. While one can argue about the optimal size of government spending, it is surely the case that there are at least some benefits to government expenditure. From a micro perspective, government expenditure is useful to the extent to which it resolves “public good” problems. Public goods are goods which are both non-excludable and non-rivalrous. Non-excludability means that it is difficult or impossible to exclude people from using a good once it has been produced. Non-rivalrous means that use of a good by one person does not prohibit another from using the good. A classic example of a public good is military defense. If there is a town with 100 people in it protected by an army, it is difficult to use the army to defend the 50 people in the town who are paying for the army while not defending the 50 people who are not paying. Rather, if the army provides defense, it provides defense to all the people in the town, whether they pay for it or not. Likewise, 50 of the people in the town enjoying the defense provided by the army does not exclude the other 50 people in the town from also enjoying that defense. Other examples of public goods are things like roads, bridges, and parks. While it may be possible to exclude people from using these (one can charge a toll for a road or an entry fee for a park), and while these goods may not be strictly non-rivalrous (a ton of people on the road may make it difficult for someone else to drive onto the road), in practice goods like these have characteristics similar to a strict public good like military defense. Public goods will be under-provided if left to private market forces. Because of the non-excludability, private

firms will not find it optimal to produce public goods – why produce something if you can't make people pay for it? Governments can step in and provide public goods and therefore increase private welfare.

As with our discussion of money, it is not an easy task to model in a compelling yet tractable way the public good provision problem in a macroeconomic model. As with money, it is common to take short cuts. In particular, it is common to assume that the household receives utility from government spending. In particular, let $h(\cdot)$ be a function mapping the quantity of government expenditure into the utility of a household, where it is assumed that $h'(\cdot) > 0$ and $h''(\cdot) < 0$. Let household lifetime utility be given by:

$$U = u(C_t, 1 - N_t) + v\left(\frac{M_t}{P_t}\right) + h(G_t) + \beta u(C_{t+1}, 1 - N_{t+1}) + \beta h(G_{t+1}) \quad (15.39)$$

In (15.39), in each period the household receives a utility flow from government spending. The future utility flow is discounted by β . The exact form of the function $h(\cdot)$ is not particularly important (other than that it is increasing and concave), though it is important that utility from government spending is additively separable with respect to utility from other things. Additive separability means that the solution to the household's optimization problem (or the planner's optimization problem) with respect to non-government spending variables is the same whether the household gets utility from government spending or not. What this means is that ignoring utility from government spending, as we have done to this point, does not affect the optimality conditions for other variables.

The budget constraints faced by the planner are unaffected by the inclusion of utility from government spending in the specification of lifetime utility. We can write the modified unconstrained version of the optimization problem (after substituting out the constraints) as:

$$\begin{aligned} \max_{N_t, N_{t+1}, K_{t+1}, M_t} \quad & U = u(A_t F(K_t, N_t) - K_{t+1} + (1 - \delta)K_t - G_t, 1 - N_t) + v\left(\frac{M_t}{P_t}\right) + h(G_t) + \dots \\ & \dots + \beta u(A_{t+1} F(K_{t+1}, N_{t+1}) + (1 - \delta)K_{t+1} - G_{t+1}, 1 - N_{t+1}) + \beta h(G_{t+1}) \end{aligned} \quad (15.40)$$

The optimality conditions for the planner with respect to N_t , N_{t+1} , K_{t+1} , and M_t are the same as above. The new optimality conditions with respect to the choices of G_t and G_{t+1} are:

$$\frac{\partial U}{\partial G_t} = -u_C(C_t, 1 - N_t) + h'(G_t) \quad (15.41)$$

$$\frac{\partial U}{\partial G_{t+1}} = -\beta u_C(C_{t+1}, 1 - N_{t+1}) + \beta h'(G_{t+1}) \quad (15.42)$$

Setting these equal to zero and simplifying yields:

$$h'(G_t) = u_C(C_t, 1 - N_t) \quad (15.43)$$

$$h'(G_{t+1}) = u_C(C_{t+1}, 1 - N_{t+1}) \quad (15.44)$$

Expressions (15.43)-(15.44) say that, an optimum, government spending should be chosen so as to equate the marginal utility of government spending with the marginal utility of private consumption. We can think about these optimality conditions as also representing marginal benefit equals marginal cost conditions. $h'(G_t)$ is the marginal benefit of extra government expenditure. What is the marginal cost? From the resource constraint, holding everything else fixed, an increase in G_t requires a reduction in C_t . Hence, the marginal utility of consumption is the marginal cost of extra government spending. At an optimum, the marginal benefit ought to equal the marginal cost. The optimality condition looks the same in both period t and $t + 1$.

Let us relate these optimality conditions back to the simpler case where the benevolent planner takes G_t and G_{t+1} as given. In that case, the planner would choose the same allocations that emerge as the outcome of a decentralized equilibrium. As such, the equilibrium outcome is efficient and there is no role for changing G_t or G_{t+1} in response to changing exogenous variables. That is not going to be the case when G_t and G_{t+1} can be optimally chosen by the planner. In particular, (15.43)-(15.44) indicate that government spending ought to move in the same direction as consumption. In periods when consumption is high, the marginal utility of consumption is low. Provided $h''(\cdot) < 0$, this means that government spending ought to be adjusted in such a way as to make the marginal utility of government spending low, which requires increasing G_t . The opposite would occur in periods in which C_t is low. Put another way, procyclical fiscal policy is optimal (by procyclical we mean moving government expenditure in the same direction as consumption) when the benefits of government expenditure are modeled in this way. Note that this runs counter to conventional wisdom, which holds that government spending ought to be high in periods where the economy is doing poorly (i.e. periods in which consumption is low).

15.2 Summary

- In the production economy, prices adjust to simultaneously equilibrate all markets. As it turns out, this equilibrium is efficient in the sense that the allocations correspond to the allocations a social planner would decide if his or her goal was to maximize the

representative household's present discounted value of lifetime utility.

- The result that the competitive equilibrium is efficient implies that a social planner cannot do a superior job relative to the market economy in allocating resources. We say that the competitive equilibrium is Pareto efficient which means the allocations cannot be reallocated by a social planner to improve welfare.
- This is an example of the First Welfare Theorem which says under conditions of perfect competition, no distortionary taxation, and perfect financial markets, all competitive equilibrium are efficient. An implication is that activist policy, whether monetary or fiscal, can only reduce welfare.
- The marginal benefit to holding real money balances is positive and the marginal cost to printing money is zero. Therefore, the social planner would like expand real money balances as much as possible. This condition can be implemented by setting the nominal interest rate equal to 0. Provided the long-run real interest rate is positive, this implies the long-run rate of inflation should be negative. This is called the Friedman rule.
- Until this chapter, we have assumed government spending is neither productive nor provides people utility. These assumptions imply the optimal level of government spending is zero. On the other hand, if people receive utility from government spending then the social planner would equate the marginal utility of consumption and the marginal utility of government spending. Somewhat paradoxically, this implies that government spending should be procyclical. That is, the social planner would raise government spending in booms and decrease spending during recessions.

Key Terms

- Pareto efficient allocation
- First Welfare Theorem
- Friedman rule
- Public goods

Questions for Review

1. What does it mean for allocations to be Pareto efficient? What are the policy implications?
2. Explain the economic logic of the Friedman rule. What does the Friedman rule imply about the time path of prices?

3. What assumptions imbedded in the Neoclassical model are essential for the Pareto optimality of the allocations?
4. If the representative household receives utility from government expenditures, should a benevolent government increase or decrease expenditures during recessions?

Exercises

1. In the text we have assumed the representative agent does not derive utility from government expenditures. Instead, consider the one period problem where the representative agent derives utility from consumption and government spending

$$U = u(C) + v(G)$$

Both $u(C)$ and $v(G)$ are increasing and concave. The household is exogenously endowed with Y . Since this is a one period model, the government balances its budget in every period. Once the government chooses a level of expenditure, the representative agent consumes whatever remains of the endowment. Hence, we can think about this problem as one where the government chooses the level of government spending and consumption to maximize the representative agent's utility function. Formally, the problem is

$$\max_{C,G} u(C) + v(G)$$

$$\text{s.t. } C + G = Y.$$

- (a) Write this as an unconstrained problem where the government chooses G .
 - (b) Derive the first order condition.
 - (c) Suppose $u(C) + v(G) = \ln C + \ln G$. Solve for the optimal levels of G and C .
 - (d) If the economy is in a recession (i.e. low Y), should a benevolent government increase or decrease government expenditures? What is the economic intuition for this?
2. One of the assumptions that goes into the Neoclassical model is that there are no externalities. Here we discard that assumption. Suppose that the process for turning output into productive capital entails damage to the environment of $D_t = \phi(I_t)$ where $\phi(I_t) > 0$ provided $I_t > 0$ and $\phi' > 0$, $\phi'' > 0$.

We assume this cost provides disutility to the consumer so that the present discounted value of utility is

$$U = u(C_t) - D_t + \beta u(C_{t+1})$$

where we have assumed labor is not a factor of production. Note that the household only receives disutility in the first period since investment is negative in the second period (we also assume a parameter restriction such that $I_t > 0$ is optimal in period t). The production function is $Y_t = A_t F(K_t)$. The capital accumulation equations are

$$K_{t+1} = I_t + (1 - \delta)K_t$$

$$K_{t+2} = I_{t+1} + (1 - \delta)K_{t+1}$$

The terminal condition continues to be $K_{t+2} = 0$. The market clearing condition is $Y_t = C_t + I_t$.

- (a) Formulate this as a social planner's problem in which the only choice variable is K_{t+1} .
- (b) Derive the first order condition on K_{t+1} .
- (c) If firms do not account for the environmental damage will there be too much or too little investment? Prove this by finding the first order condition of the firm's profit maximization problem.
- (d) How might an activist government restore the Pareto optimal allocation? Be as specific as possible.

Chapter 16

Search, Matching, and Unemployment

An individual is classified as unemployed if she is not working but actively searching for work. In the microeconomically-founded model we have considered in this section of the book, there is no unemployment. In equilibrium, the real wage adjusts so that the quantity of labor supplied equals the quantity of labor demanded. There is no such thing as an individual who would like to work at the prevailing market wage but cannot find work. Indeed, the most common macroeconomic models (both the neoclassical and New Keynesian models, as described and studied in Parts IV and V) used among academics and policymakers have this feature that there is no unemployment as it is defined in the data. While these models can speak to labor market variables like wages and total hours worked, they are silent on the issue of unemployment. This is a potentially important omission, for at least two reasons. First, the financial and business press, as well as non-academic policymakers, are quite focused on unemployment statistics. Second, as documented in Chapter 1, the majority of variation in total hours worked comes from individuals transitioning into and out of work as opposed to already employed workers varying the intensity of their work.

Part of the reason that macroeconomic models often abstract from unemployment is that it is not trivial to incorporate unemployment, as it is defined into the data, into relatively simple modeling frameworks. In particular, thinking about unemployment requires moving away from the representative agent assumption and allowing for heterogeneity among both workers and firms. In this chapter, we build a model in which there are a continuum of workers and firms.¹ In equilibrium, some workers are unmatched with firms and some firms are unmatched with workers – i.e. there exists unemployment. We can use the model to think about issues related to the level of unemployment and why it changes over time. Before introducing the model, we start with some stylized facts about the labor market.

¹“Continuum” is a fancy word that roughly means “a lot.” Formally, assuming a continuum of agents allows for there to be many agents, but there are so many agents that each individual agent behaves as a price-taker.

16.1 Stylized Facts

We have already defined the unemployment rate and showed how it varies over time (see, e.g., Figure 1.6 in Chapter 1). Here we focus on the determinants of the unemployment rate – job creation, job destruction, and separations.

Before 2000, there was very little high frequency data available on the demand side of the labor market. The Job Openings and Labor Turnover Survey (JOLTS), conducted by the Bureau of Labor Statistics changed that. JOLTS is a monthly establishment level survey that collects data on job postings, new hires, and separations at the private sector. A separation occurs when an employer and a worker end their relationship. The other data set we use comes from the Current Population Survey (CPS) which is a monthly survey that keeps track of labor market outcomes across individuals. The monthly CPS started in 1979. The data displayed below can be downloaded from the Federal Reserve Bank of St. Louis [FRED](#).

1. **There are an enormous number of jobs are created and destroyed each month.**

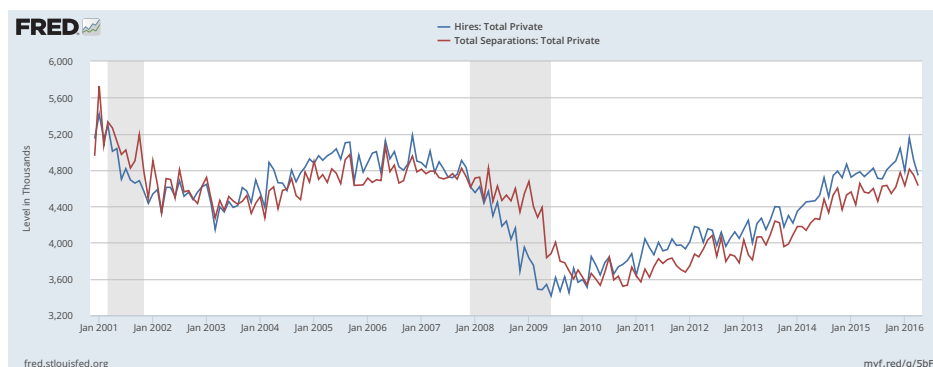

Figure 16.1: Total Hires and separations in the US 2000-2016

Take a careful look at Figure 16.1. Note that the vertical axis is in *thousands*. That means over five million jobs were created and five million jobs were destroyed in the first month of 2001. Even during the depths of the Great Recession, more than three million jobs were created each month, which may be counterintuitive given how much discussion there was about the underperformance of the job market. However, as our next item shows, the fact that many jobs were created during the Great Recession does not mean the labor market was healthy.

2. **Net job creation is procyclical**

When the number of hires exceed the number of separations, employment expands. Another way of saying this is that there is positive net job creation. The reverse is

true if separations exceed new hires. Figure 16.2 plots net job creation, which is the difference between total hires and total separations in Figure 16.1. We observe that net job creation is clearly countercyclical. For example, at the height of the Great Recession there were close to one million net jobs destroyed. This more closely jives with our basic intuition about the labor market. However, as we have just seen, these net creation numbers mask the large amount of jobs created and destroyed each month.

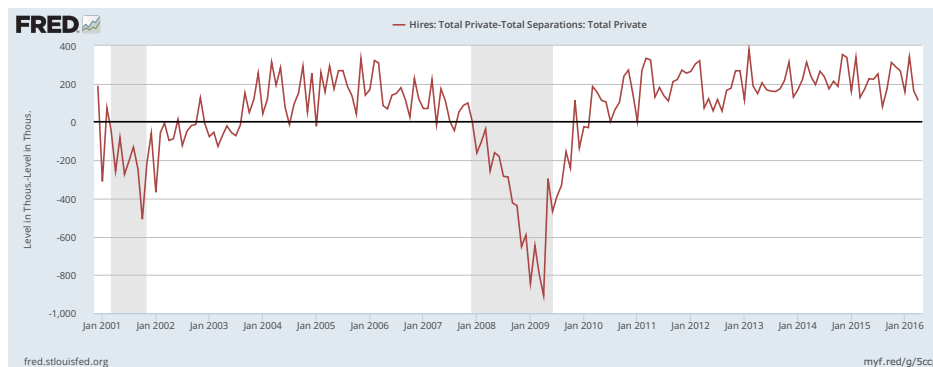

Figure 16.2: Net job creation in the US 2000-2016.

3. During recessions, the number of quits fall and the number of layoffs rise.

Separations can be divided into two categories: quits and layoffs/discharges. A separation is classified as a quit when an employee departs voluntarily. Layoffs and discharges occur when the employee leaves involuntarily. In other words, when the employer decides to end the relationship, the separation is called a layoff or discharge; when the employee ends the relationship, the separation is called a quit. Sometimes separations do not clearly fall into either of these categories. For instance, if an employee is forced to resign, would that show up as a quit or a layoff? All of these ambiguous cases are classified as “other separations.” Retirements also go into the “other separations” category.

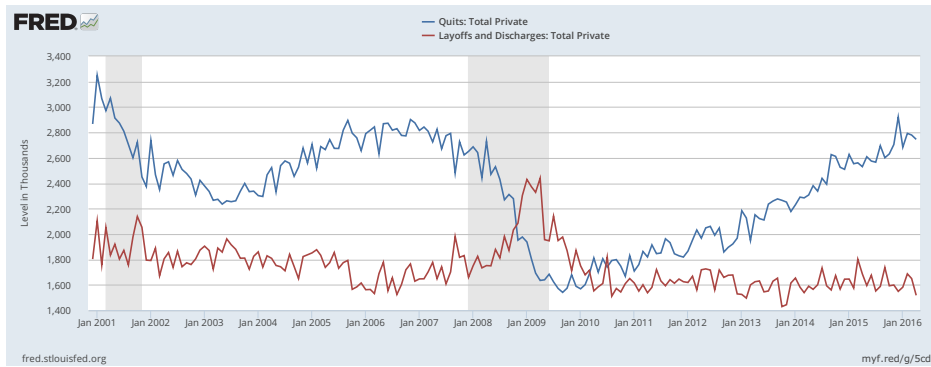

Figure 16.3: Separations in the US 2000-2016.

Figure 16.3 shows that the number of quits usually exceeds the number of layoffs and discharges. In other words, most of the time the majority of job separations are *voluntary*. An exception is the latter half of the Great Recession, when discharges exceeded quits by a sizeable amount. We observe that quits fall during recessions and layoffs rise. One reason for this is that workers are less likely to quit their job and search for greener pastures when the job market is poor. At the same time, during recessions firms tend to demand less labor. One way in which this lower demand for labor is manifested is through the termination of existing employment relationships.

4. Not all people looking for work find a job

This may be obvious (especially for those of you who have looked for a summer employment), but not everyone looking for a job is immediately successful. Mechanically, the *job finding rate* equals the number of working-age people transitioning from unemployment to employment divided by the number of working-age unemployed people. During expansions the job finding rate rises and during recessions it falls. Figure 16.4 plots the job finding rate over time in the US. In addition to being procyclical, another interesting feature of 16.4 is that the job finding rate has generally been declining over time. This is important for several reasons. First, the longer a person remains unemployed the more their skill depreciates. If a carpenter is unemployed for one month, he is unlikely to forget how to install wood floors. However, if the same carpenter is unemployed for one year, he is likely to be more rusty when he starts installing floors again. Second, less output can be produced if it takes longer for firms and workers to meet each other. Finally, if the unemployed person is receiving unemployment benefits, a lower job finding rate implies a longer unemployment duration. Therefore, there are higher fiscal costs when the job finding rate is low. The job creation rate reached a nadir in the Great Recession and has subsequently recovered although not to all the

way to its high in 2000.

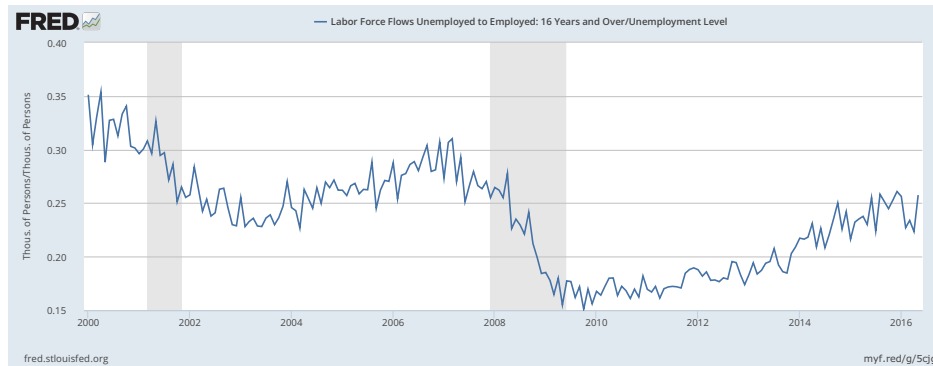

Figure 16.4: Job finding rate in the US 2000-2016.

5. There is a negative relationship between the vacancy and unemployment rates

Recall that the unemployment rate is the number of unemployed individuals divided by the labor force. The vacancy rate is the number of job postings divided by the sum of the number of job postings and employment. If employment is low and the number of job postings are high, the vacancy rate is also high. Figure 16.5 shows that there is a negative relationship between the unemployment rate and the vacancy rate in the data. When the vacancy rate is high and the unemployment rate is low, the prospects for individuals looking for work are good. When the reverse is true, prospects are bad. The negative relationship between vacancies and unemployment is called the [Beveridge curve](#) after the British economist William Beveridge.

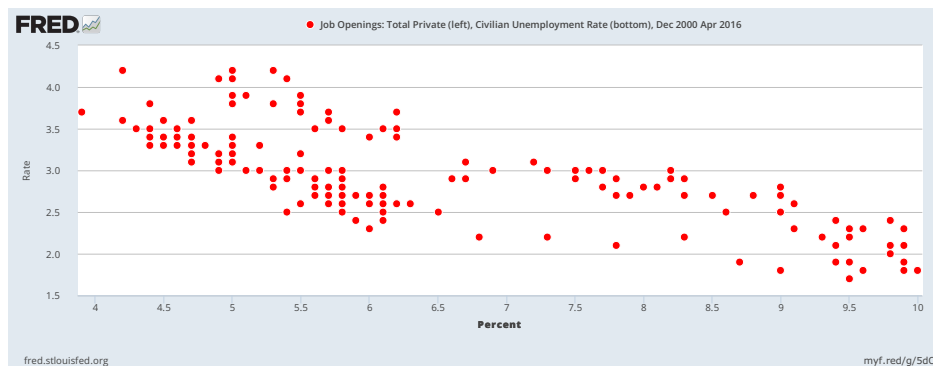

Figure 16.5: Job finding rate in the US 2000-2016.

A final note about the Beveridge curve is that it gives us some insight into the efficiency of the labor market. Points to the northeast are in some sense less efficient than points

closer to the origin. Why is this? At the origin no firms are posting jobs and no one is unemployed. Consequently, everyone in the economy who wants to work and every firm that wants to employ a worker are in fact matched together and are producing output. Moving farther away from the origin means that there are more unmatched workers and firms so less output is being produced. One caveat is that just because workers and firms are matched does not imply that those matches are productive. For example, workers could be stuck in a low productivity job because they do not have the resources to migrate to more productive localities.

16.2 The Bathtub Model of Unemployment

Before launching into an equilibrium model of unemployment with optimizing agents, we can put a little more structure on how we think about the relationship between the unemployment rate, separation rate, and the job finding rate. Imagine a bathtub that is partially full with water. The faucet is turned on putting more water in the tub, but the drain is also unplugged allowing water to escape. If more water is coming through the faucet than leaving, the tub deepens. If more water is going down the drain, the tub gets more shallow. Job creation is like water coming from the faucet and increases total employment. Separations are like water going down the drain as they subtract from the water in the tub. The water in the tub is akin to the level of employment. It only changes to the extent jobs are created or destroyed.²

This is conceptually similar to the process of capital accumulation studied in Part II. In other words, we ought to think about there being a *stock* of employed workers. Separations and matches represents *flows*. Compared to long run models of capital accumulation, employment plays the role of the capital stock, new job matches the role of investment, and separations the role of depreciation. The unemployed are those who have been involuntarily separated from a job match or have been searching and unable to find a match.

Let us now be more formal in describing the evolution of the stock of unemployed workers. Let u_t denote the number of unemployed workers in period t . This is predetermined and cannot change within period t . Denote the job separation rate by s and the job finding rate by f . Think of these as time invariant parameters. Unemployment evolves over time according to the following law of motion:

$$u_{t+1} - u_t = -fu_t + s(1 - u_t). \quad (16.1)$$

²It is not quite clear whether quits should be analogized to water leaving the tub since presumably many of these workers are moving to other jobs.

(16.1) says that the change in unemployment between t and $t + 1$, i.e. $u_{t+1} - u_t$, depends negatively on matches, $f u_t$, and positively on separations, where $s(1 - u_t)$ denotes the number of separated workers in period t . If matches exceed separations, the unemployment rate declines. If separations exceed job finding, the unemployment rate increases. Similarly to the growth models considered in Part II, there exists a steady state in which the unemployment rate is constant, which means $u_{t+1} = u_t = u^*$. Imposing this condition yields

$$0 = -f u^* + s(1 - u^*) \Leftrightarrow u^* = \frac{s}{s + f} \quad (16.2)$$

Equation 16.2 shows that the steady state unemployment rate is higher when the separation rate is higher or the finding rate is lower. Similar to models of long run growth, if $u_t < u^*$ then the economy will transition to a higher unemployment rate and vice-versa. Let's consider some numbers based on real-world data. The job finding rate for the first few months of 2016 hovered around 25 percent. The layoffs and discharges rate was around 1.2 percent and the quit rate was around 2 percent. Since many people who quit are transferring to another job rather than entering unemployment, it would not be correct to count them as separations in this model. Suppose one quarter of quits transition to unemployment. Then, the separation rate is $0.25(2) + 1.2 = 1.7$ percent. If the separation and job finding rate remain the same going forward in time, the long run unemployment rate would be:

$$u^* = \frac{0.017}{0.017 + 0.25} = 0.064$$

Hence, the long run unemployment rate is around 6.4 percent. At the beginning of 2016 the unemployment rate was 4.7 percent. If our numbers for the separation and job finding rates are correct and constant, we would have expected the unemployment rate to rise from that time. This is in fact not what has happened, where the unemployment rate has continued to decline into 2018.

16.2.1 Transition Dynamics: A Quantitative Experiment

As above, suppose that our initial value of unemployment is 4.7 percent and the steady-state value is 6.4. Assume that the separation and job finding rates are constant. Similarly to growth models, we can compute the transition dynamics sequentially.

$$\begin{aligned} u_1 &= u_0 - f u_0 + s(1 - u_0) \\ \Leftrightarrow u_1 &= 0.047 - 0.25(0.047) + 0.017(1 - 0.047) = 0.0515 \end{aligned}$$

If the current unemployment rate is 4.7 percent, our simple descriptive model would

predict it should rise to 5.15 percent a month later. Going two months into the future, we would have:

$$u_2 = u_1 - fu_1 + s(1 - u_1)$$
$$\Leftrightarrow u_2 = 0.0515 - 0.25(0.0515) + 0.017(1 - 0.0515) = 0.0547.$$

Note that the change between u_2 and u_1 is smaller than the difference between u_1 and u_0 and with each change the unemployment rate comes closer and closer to the steady-state unemployment rate. Formally, one can show that this difference equation converges to a unique steady state. However, we will leave the details to the more mathematically inclined reader.

The transition dynamics can be plotted in Excel or some other software as we do below. The top panel of Figure 16.6 shows that the unemployment rate converges monotonically to its steady state. Within about a year, the unemployment rate almost completely converges.

Now consider the following counterfactual experiment. Suppose that after ten months, the separation rate drops to 0.01 and is expected to forever remain that this lower level. Then, the unemployment rate in month 11 is computed by

$$u_{11} = u_{10} - 0.25u_{10} + 0.01u_{10}$$

We can then iterate forward in time using this new separation rate. The results are displayed in the bottom panel of Figure 16.6. In the first ten periods, the unemployment rate is exactly the same because the parameters are identical. In period 11, the counterfactual separation rate drops to 0.01. This results in the unemployment rate falling and continuing to fall as it transitions to a new steady state. The new transition dynamics are outlined with a dotted line while the solid line traces out the transition dynamics when the separation rate stays the same. The solid line simply converges to the old steady state of 6.4 percent, but the dashed line converges to 3.9 percent reflecting the lower separation rate.

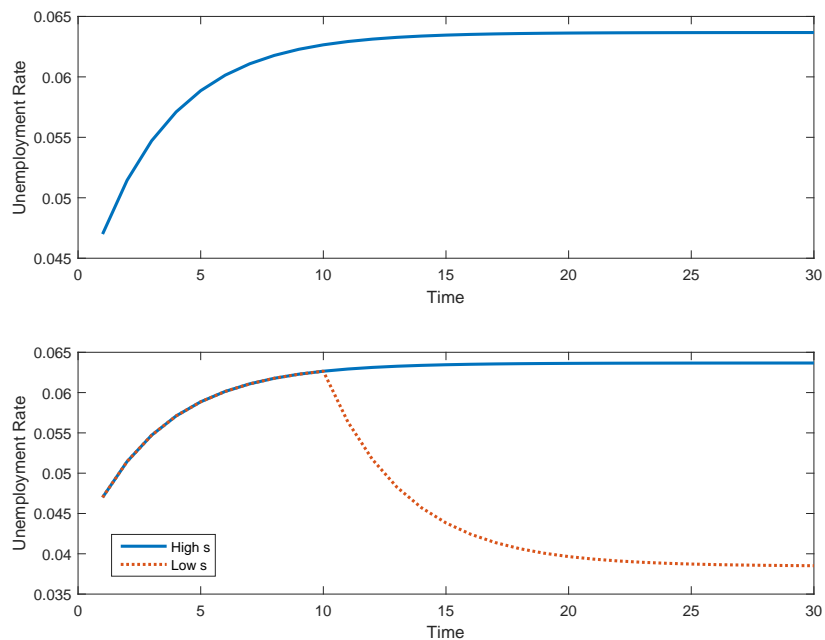

Figure 16.6: The top panel shows the transition dynamics starting at $u_0 = 0.047$. The bottom panel shows the transition dynamics associated with moving to a lower separation rate.

The bathtub model gives us a way to account for movements between employment and unemployment and dynamic behavior over time. However, it is atheoretical – there is no optimization that results in *endogenous* values of the job finding and separation rates. In the next section, we go over a theory of unemployment and how the job finding rate is endogenously determined in equilibrium. For simplicity, we will continue to assume a constant separation rate.

16.3 Two Sided Matching: The Diamond-Mortensen-Pissarides Model

Hiring employees is not costless. A business must recruit qualified applicants, interview them, and ultimately decide whom to hire. Creating a job consumes resources. Also, even when the business posts a vacancy, it does not always fill the job. Sometimes they just do not meet the right person or the right person accepts a better job offer. Similarly, sometimes a prospective employee just does not find the right place to work. The models we have considered to this point ignore these features of reality.

Two sided matching models were developed by Peter Diamond, Dale Mortensen, and Christopher Pissarides to address these attributes that characterize labor markets.³ These models make the assumption that vacancy creation is costly and that there are frictions impeding how prospective employees and employers meet each other. These frictions are embodied in something called the matching function.

16.3.1 The Matching Function

Recall that the production function takes capital and labor as inputs to create some output. Higher productivity increases the efficiency with which inputs are transformed into output. Much in the same way, we assume the existence of a matching function that takes the number of unemployed individuals and vacancy postings as inputs and creates new hires as an output. Formally, the matching function we assume is:

$$H_t = \psi_t M(u_t, V_t) \tag{16.3}$$

H_t , u_t , and V_t are the number of new hires, the existing stock of unemployed workers, and vacancies posted by firms, respectively. ψ_t measures the efficiency of the matching function. The higher is ψ_t the more matches are created for a given number vacancies and unemployment. We assume the following properties of the matching function.

1. The matching function is bounded below by 0.

$$0 \leq \psi_t M(u_t, V_t)$$

2. If there are no vacancies or no unemployment, there are no hires.

$$\psi_t M(0, V_t) = \psi_t M(u_t, 0) = 0$$

³See [Diamond \(1982\)](#), [Pissarides \(1985\)](#), and [Pissarides and Mortenson \(1994\)](#).

3. The number of matches cannot exceed the minimum of the number of vacancies and unemployment.

$$H_t \leq \min [u_t, V_t]$$

4. The matching function is increasing at a decreasing rate in vacancies and unemployment.

$$\psi_t M_u(u_t, V_t) > 0, \psi_t M_v(u_t, V_t) > 0$$

$$\psi_t M_{uu}(u_t, V_t) < 0, \psi_t M_{vv}(u_t, V_t) < 0$$

5. The matching function has constant returns to scale in unemployment and vacancies. Hence, for $\lambda > 0$

$$\psi_t M(\lambda u_t, \lambda V_t) = \lambda \psi_t M(u_t, V_t)$$

The first point says that the number of matches cannot be negative. Point two says that if there are no unemployed people or no vacancies, there are no matches. Point three says that the number of hires cannot exceed the number of unemployed or the number of vacancies. Note that if there were no frictions in the labor market, the number of matches would equal the lesser of the number of vacancies and unemployed. Given matching frictions, this will generally not be true. The fourth point says that the matching function is increasing in both inputs at a decreasing rate. The final point says that the matching function is constant returns to scale. If you double the number of vacancies and double the number of unemployed you exactly double the number of matches.

The matching function quite obviously looks similar to the production function we have used to map labor and capital inputs into output. Similar to a production function, the matching function can be a bit of a black box. Reality is complex. We do not know how exactly firms combine inputs into making output just like we do not know what precise frictions cause unemployment. However, much like the production function, the matching function is a useful abstraction as a reduced form way to model the frictions giving rise to unemployment. Given this abstraction we can consider the effects of various exogenous changes to the labor market.

As above, we can define the job finding rate as the ratio of new hires to the initial stock of unemployed, or $f_t = \frac{H_t}{u_t}$. Formally:

$$f_t = \frac{\psi_t M(u_t, V_t)}{u_t} = \psi_t M\left(1, \frac{V_t}{u_t}\right). \quad (16.4)$$

The second equality in (16.4) follows from the constant returns to scale assumption. Note that the job finding rate is increasing in the ratio of vacancies to unemployment. This makes

sense: the more jobs postings there are relative to people looking for work, the easier it is to find a job. We can also define a new term which we shall call the job filling rate. We will denote this with q_t . It is equal to the fraction of news hires relative to total vacancies. Formally:

$$q_t = \frac{\psi_t M(u_t, V_t)}{V_t} = \psi_t M\left(\frac{u_t}{V_t}, 1\right). \quad (16.5)$$

The job filling rate is decreasing in the vacancy to unemployment ratio. The more vacancies there are relative to unemployment, the more difficult it will be to fill any one vacancy. The ratio of vacancies to unemployment, or $\frac{V_t}{u_t}$, is often referred to as “labor market tightness.” When the labor market is “tight” it is relatively easy for workers to find a job (i.e. f_t is high). Conversely, when the labor market is “slack” it is easy for firms to fill a job, but difficult for workers to find a job (i.e. q_t is high but f_t is low).

16.3.2 Household and Firm Behavior

While the more general version of this model is cast in an infinite horizon context, we consider a one-period version of the model. A one-period version of the model generalizes to the multi-period version if the separation rate is $s = 1$. In other words, at the beginning of each period *all* households are unemployed. During a period, some households find jobs and others do not. At the end of the period, those households who did find jobs separate. Then, the next period begins exactly as the first period began, with all households unemployed. With a separation rate of 1, nothing a household does in t affects its choice set in $t + 1$, so the model can effectively be thought of as static. Much of the logic we develop in the simple one-period model nevertheless generalizes to a multi-period framework with a separation rate less than one.

There exists a continuum of households. Technically, these households are indexed by j along the unit interval, $[0, 1]$. The continuum assumption along the unit interval technically means that (i) there are an infinite number of households, so that each household is “small” relative to the total population and consequently takes prices as given; and (ii) the total “number” of households is nevertheless normalized to one. This is convenient because if the total number of households is normalized to one, then there is no distinction between the level of unemployment and the unemployment rate. Because of the implicit assumption of a separation of one each period, all households begin a period as unemployed. They are therefore ex-ante identical and we need not keep track of the household index j . This also means that $u_t = 1$, so that $\frac{V_t}{u_t} = V_t$.

For simplicity assume that a household’s utility function is simply linear in its consumption

(i.e. we are not modeling disutility from work or utility from leisure), which in a static context simply equals total income. If the household searches for a job, it finds a job with probability f_t and this job pays it w_t units of income. The household does not find a job with probability $1 - f_t$. If it doesn't find a job, a household receives $b \geq 0$ in unemployment benefits. Therefore, a household's utility is:

$$\mathbb{U} = f_t w_t + (1 - f_t) b = b + f_t (w_t - b) \quad (16.6)$$

There similarly exist a continuum of firms with total size normalized to one. Firms can be indexed by k . Each firm decides at the beginning of the period whether or not to enter the labor market. Upon entering the market, they post a vacancy at a cost of κ . With probability q_t , they fill the vacancy and produce z_t units of output. z_t is exogenous.⁴ In the case of a match, the firm earns a profit of $z_t - w_t - \kappa$. With probability $1 - q_t$, the firm fails to match with a worker and produces nothing, thereby earning profit of $-\kappa$. Because none of the payoffs depend on firm-specific characteristics, the expected profit for a firm choosing to post a vacancy is therefore:

$$\Pi = -\kappa + q_t (z_t - w_t) + (1 - q_t) 0. \quad (16.7)$$

In other words, firms that enter the market make an investment of κ for the potential to earn $z_t - w_t$ with probability q_t .

16.3.3 Equilibrium

The unemployment rate (equivalent to the level of unemployed) at the beginning of a period is $u_t = 1$. Let u'_t denote the unemployment level/rate at the *end* of a period. We use a ' superscript rather than a $t + 1$ because all of the action in this model occurs *within* a period. The endogenous variables of interest are V_t , u'_t , and w_t . To determine the values of these variables in equilibrium, we must take a stand on how firms enter the labor market (i.e. decide whether or not to post a vacancy). We shall assume what is called a free-entry condition. This free-entry condition requires that, in equilibrium, the profit of any firm posting a vacancy is $\Pi = 0$. If this were not the case, all firms would want to post a vacancy (if $\Pi > 0$) or no firms would want to post a vacancy (if $\Pi < 0$). $\Pi = 0$ means that firms are indifferent between trying to hire in a period or not. Making use of this free-entry condition, we can solve (16.7) for the job filling rate, q_t :

⁴Technically, we can think about a firm's production as being linear in labor input, i.e. $y_t(k) = z_t n_t(k)$. If a firm gets a match, it has $n_t(k) = 1$ and produces z_t . If the firm does not find a match, it produces 0.

$$q_t = \frac{\kappa}{z_t - w_t}. \quad (16.8)$$

Remember that q_t is decreasing in the number of vacancies. If wages go up, the right hand side of equation 16.8 goes up. Firms post fewer vacancies, increasing q_t . The logic is reversed if z_t increases. However, since wages are an equilibrium object, we have not solved the model yet.

How should wages be determined? In your principles of economics classes (and indeed throughout much of this book) the wage is equal to the marginal product of labor. This relies on some notion of perfect competition in the labor market. In a model like this, however, with random search and matching, the assumption of perfect competition is untenable. A worker randomly matches with a firm. If they cannot agree over a wage, the match dissolves. The firm earns zero profit and the worker earns an outside option of b . No one gets an opportunity to “rematch.” Consequently, we need a rule for how the workers and firms split the surplus of successful matches. We follow the most common approach for dividing the surplus, which is called Nash Bargaining.⁵ In the Nash Bargaining problem, a matched worker and firm choose the w_t to maximize the joint product of their individual payoffs to producing minus their “outside options.” An outside option is whatever the best alternative to not engaging in the match is. Since the firm produces nothing if it does not match with a worker, its outside option is zero.⁶ Hence, a firm’s payoff from a successful match is $z_t - w_t$. This is the same across all firms. If a worker does not match with a firm, it receives unemployment benefits of b . If it does match, it receives w_t . So the worker’s payoff to the match minus its outside option is $w_t - b$. Like for the firm, this payoff is identical for all households and we needn’t keep track of j or k indexes.

Formally, the Nash bargaining problem can be written:

$$\max_{w_t} (z_t - w_t)^\chi (w_t - b)^{1-\chi}. \quad (16.9)$$

χ is a parameter between zero and one. It represents the relative bargaining weights of households and firms. The closer χ is to one, the greater the bargaining weight of the firm. Conversely, as χ approaches zero, the household has all the bargaining power. The first order optimality condition can be found by taking the derivative with respect to w_t and equating it to zero. Doing so, we obtain:

$$-\chi(z_t - w_t)^{\chi-1}(w_t - b)^{1-\chi} + (1 - \chi)(z_t - w_t)^\chi(w_t - b)^{-\chi} = 0$$

⁵See Nash (1950).

⁶It is true that a firm pays a fixed cost to post a vacancy, but this cost is sunk once the decision to post a vacancy has been made and is therefore not relevant for a firm’s outside option.

Simplifying, one obtains:

$$\begin{aligned}\chi(w_t - b) &= (1 - \chi)(z_t - w_t) \\ \Leftrightarrow w_t &= (1 - \chi)z_t + \chi b.\end{aligned}\tag{16.10}$$

(16.10) has an intuitive interpretation – the equilibrium wage is a linear combination of the output from a match, z_t , and the household’s outside option, b . As χ goes to zero, we get $w_t = z_t$. In this case, workers capture all the surplus of a match. In contrast, as $\chi \rightarrow 1$, the firm has all the bargaining power, so workers are paid the minimum required to get them to search, which equals their outside option of b . The wage outcome can be substituted into the free entry condition to find an expression for the job filling rate, q_t :

$$q_t = \frac{\kappa}{\chi(z_t - b)}.\tag{16.11}$$

(16.11) pins down the job-filling rate. Note two things. First, we require that $z_t > b$. If $b > z_t$, it would never make sense for households to search – the maximum wage they can earn is z_t , and if their outside option is greater than this, they would never choose to work. Second, as $\chi \rightarrow 0$ we have $q_t \rightarrow \infty$. As $\chi \rightarrow 0$, a firm has no bargaining power, and the equilibrium wage is $w_t = z_t$. But if this is the wage, the firm makes a negative profit of κ by posting a vacancy. Hence, no firms would choose to post any vacancies. If total vacancies are zero, then the vacancy filling rate is undefined/infinite.

(16.11) implicitly determines the number of vacancies posted, V_t . How can we see this? First, note that $u_t = 1$ – i.e. all households begin the period unemployed. Second, combine (16.11) with (16.5). Doing so, we get:

$$\frac{\kappa}{\chi(z_t - b)} = \psi_t M\left(\frac{1}{V_t}, 1\right)\tag{16.12}$$

(16.12) is now one equation in one unknown, V_t . To explicitly solve for V_t we need to make a functional form assumption on the matching function, $M(\cdot)$. But once we have V_t , we can determine the job finding rate, f_t , from (16.4):

$$f_t = \psi_t M(1, V_t)\tag{16.13}$$

Once we have the job finding rate, we can determine the end of period unemployment level, u'_t . Since all households begin as unemployed, the end of period unemployment is simply one minus the job finding rate, or:

$$u_t' = 1 - f_t \tag{16.14}$$

To gain some additional insights, in the next subsection we specify a particular functional form for $M(\cdot)$ which allows us to clearly elucidate several results.

16.3.4 Example

We assume that the matching function is Cobb Douglas, similar to our preferred production function specification throughout the rest of the book. In particular, with $0 < \rho < 1$, let:

$$H_t = \psi_t u_t^{1-\rho} v_t^\rho \tag{16.15}$$

With this functional form, $M\left(\frac{1}{V_t}, 1\right) = \psi_t V_t^{\rho-1}$. From (16.12), the total number of vacancies is therefore implicitly given by:

$$\frac{\kappa}{\chi(z_t - b)} = \psi_t V_t^{\rho-1} \tag{16.16}$$

Or:

$$V_t = \left(\frac{\psi_t \chi(z_t - b)}{\kappa} \right)^{\frac{1}{1-\rho}} \tag{16.17}$$

(16.17) provides a number of intuitive results. First, V_t is increasing in z_t . This makes sense – the larger is z_t , the bigger the potential gains to a firm from posting a vacancy. Second, V_t is also increasing in ψ_t . The bigger is ψ_t , the more efficient vacancy-posting is at generating matches, and therefore the more vacancies firms ought to want to post. Third, vacancy posting is increasing in χ , which represents a firm's bargaining weight. The bigger is χ , the more a firm stands to gain from successfully finding a match. Fourth, V_t is decreasing in the household's outside option, b . The bigger is b , the higher must be the equilibrium wage, and the lower are the gains to a firm from posting a vacancy. Finally, the number of vacancies is naturally decreasing in the fixed cost of posting a vacancy, κ .

Once we have derived an expression for the equilibrium number of vacancies, we can derive an expression for the job finding rate. In particular, we have:

$$f_t = \psi_t \left(\frac{\psi_t \chi(z_t - b)}{\kappa} \right)^{\frac{\rho}{1-\rho}} \tag{16.18}$$

The job finding rate, (16.18), is increasing in V_t , and hence depends on exogenous variables and parameters in qualitatively the same way that V_t does. In particular, the job finding

rate is greater the higher is match efficiency, ψ_t ; the higher is productivity, z_t ; the higher is the firm's bargaining weight, χ ; and the lower are the household's outside option, b , and the fixed cost of posting a vacancy, κ .

As noted above, the end of period unemployment level, u'_t , is simply one minus the job finding rate, or:

$$u'_t = 1 - f_t = 1 - \psi_t \left(\frac{\psi_t \chi (z_t - b)}{\kappa} \right)^{\frac{\rho}{1-\rho}} \quad (16.19)$$

(16.19) gives an expression for the equilibrium (end of period) unemployment level (also equivalent to the rate). It is quite intuitive. For example, the more productive is the economy (i.e. z_t is bigger), the lower will be the unemployment rate. The bigger ψ_t (i.e. the more efficient is the matching process), the lower will be the unemployment rate. The greater is the cost of posting a vacancy, the higher will be the unemployment rate.

One can use (16.19) to draw a number of useful inferences as pertains economic policy. Policies which increase unemployment benefits, modeled here as b , ought to increase the unemployment rate. This could help explain why, for example, European countries, which typically have fairly generous unemployment benefits, have higher unemployment rates on average than does the US. Similarly, policies which make the matching process less efficient result in smaller values of ψ_t and higher unemployment. Otherwise well-intentioned policies, such as the well-known [Ban the Box](#) initiative, could have unintended consequences that could result in higher unemployment. “Ban the Box” prohibits employers from asking potential employees about criminal history. The motivation behind such a policy is to prevent discrimination against those who have a criminal history. But if a firm cannot access such information, it might be wary to hire at all. The lack of information could reduce matching efficiency and actually result in higher unemployment, particularly among the groups such initiatives are intended to help. Indeed, this is in fact what some recent [research](#) suggests.⁷

16.3.5 Efficiency

Is the equilibrium of the search and matching model laid out in the previous sections efficient? To answer this question, we need to consider a social planner's problem like we did in Chapter 15 and examine whether the equilibrium allocations coincide with what a benevolent planner would choose.

We can define the planner's objective as the total output from consummated matches, which will be $z_t M(V_t, 1)$; plus the unemployment benefits accruing to unmatched households, $(1 - M(V_t, 1))b$; minus the total cost of posting vacancies, κV_t . This problem can be written

⁷See [Doleac and Hansen \(2016\)](#).

as one in which the planner simply chooses how many vacancies to post. Once V_t is known, all other allocations follow. Formally, the planner's problem is:

$$\mathcal{U} = \max_{V_t} M(V_t, 1)z_t + (1 - M(V_t, 1))b - \kappa V_t.$$

The first-order condition is

$$\frac{\partial \mathcal{U}}{\partial V_t} = 0 \Leftrightarrow M_v(V_t, 1)z_t - M_v(V_t, 1)b = \kappa. \quad (16.20)$$

This can be rearranged as

$$M_v(V_t, 1) = \frac{\kappa}{z_t - b}. \quad (16.21)$$

Recall, the free-entry condition in equilibrium is

$$q_t = \frac{\kappa}{\chi(z_t - b)}. \quad (16.22)$$

For the equilibrium allocation to be efficient, from (16.21) and (16.22) it evidently must be the case that $M_v(V_t, 1) = \chi q_t$. To make better sense of this, let us return to the Cobb-Douglas matching function example. With this matching function, we would have:

$$M_v(V_t, 1) = \rho \psi_t V_t^{\rho-1} \quad (16.23)$$

From (16.5), we have:

$$q_t = \psi_t V_t^{\rho-1} \quad (16.24)$$

Comparing (16.23)-(16.24), we can only have $M_v(V_t, 1) = \chi q_t$ if $\chi = \rho$. In other words, for the equilibrium to be efficient it must be the case that the bargaining weight of firms, χ , equals the elasticity of the matching function with respect to vacancies, ρ . In general there is no reason to expect this to be the case. If the number of vacancies increases by one percent, the number of matches increases by ρ percent. χ represents firms' bargaining power. If firms have too much bargaining power (i.e. χ is higher than ρ), they post "too many" vacancies in equilibrium. If firms do not have enough bargaining power, they post "too few" vacancies relative to the efficient benchmark. The reason why the equilibrium often fails to be optimal is because of an externality and, in particular, a congestion externality. The congestion externality here is that firms do not take into account how entering the market reduces the job filling rate for all the other firms. If their bargaining power is high, too many firms enter the market. If their bargaining power is too low, not enough firms enter into the

market relative to what a benevolent social planner would desire.

16.4 Summary

- Until this point in the book all fluctuations in the labor market were at the intensive margin, that is through the representative agent substituting work for leisure. In the data, there are enormous variations in the extensive margin, i.e. the number of people working.
- There are millions of jobs created and destroyed each month, but in recessions, net job creation is negative. Not every worker looking for a match is successful although this success rate falls in recessions. The negative relationship between unemployment and vacancies is called the Beveridge curve.
- The bathtub model shows the relationship between unemployment and the job finding and separation rates. A higher job finding rate lowers unemployment and a higher separation rate raises unemployment.
- The matching function describes how a number of vacancies and unemployed are turned into new hires. The matching function is a reduced form way of modeling frictions in the labor market.
- In the two sided matching model unemployed workers are randomly matched with firms posting vacancies. The wage is set so that the worker and firm end up splitting the surplus. In equilibrium, there is free entry of firms which drives the value of posting a vacancy to zero. This model gives us a way to understand how changes in the cost of posting vacancies, matching efficiency, worker productivity, and the separation rate affect the labor market.

Key Terms

- Beveridge curve
- Job finding rate
- Separation rate
- Labor market tightness
- Bargaining power
- Congestion externality

Questions for Review

1. What happens to net job creation during recessions? What about gross job creations?
2. List the various types of separations. How do their magnitudes change over the business cycle?
3. In a two-sided search model, why aren't wages set equal to their marginal products?

Exercises

1. In a recession, state governments often extend the length of time unemployed people can qualify for unemployment benefits. Do you think this extension of unemployment benefits would shorten or lengthen the recession? Justify your answer.
2. Suppose the matching function takes the form

$$H_t = \frac{u_t V_t}{(u_t^\phi + V_t^\phi)^{\frac{1}{\phi}}}.$$

- (a) Assuming wages are Nash bargained, solve for the equilibrium number of vacancies.
 - (b) Derive a condition under which the equilibrium number of vacancies is Pareto Optimal (i.e. efficient in the sense of being the solution to a social planner's problem).
3. Now consider the matching function

$$H_t = V_t^\rho (u_t e_t)^{1-\rho}$$

where e_t is defined as search intensity. Search intensity is how hard the households are looking for work. Looking for work carries a disutility cost of $g(e_t) = \theta e_t^\gamma$ where $\gamma > 1$.

- (a) If all households start out the period unemployed, compute the job finding and job filling rates.
- (b) Each household chooses how much effort to put into search, taking the amount of aggregate effort in the economy and the job finding rate as

given. Therefore, the objective of household i is

$$\max_{e_i} \mathbb{U} = \max_{e_i} b - \theta e_{i,t}^\gamma + \frac{e_{i,t}}{e_t} f(V_t, e_t)(w_t - b).$$

The harder household i searches relative to the amount of the average (or aggregate) search intensity, the higher its probability of finding a job. Solve for the optimal $e_{i,t}$ as a function of e_t, f_t, w_t and b .

- (c) Observe that your optimal $e_{i,t}$ is only a function of economy-wide variables (nothing involving household i). From this we can infer that all households choose the same level of intensity. So $e_{i,t} = e_t$. Solve for the economy-wide e_t taking f_t and w_t as exogenous. How does the optimal e_t respond to changes in f_t, w_t , and θ . Describe the economic intuition for all of these.
- (d) Derive the free-entry condition.
- (e) Derive the Nash bargained wage.
- (f) Solve for the equilibrium number of vacancies as a function of only exogenous variables and parameters.
- (g) How does the number of vacancies change with productivity? Does endogenous intensity amplify or dampen the response of vacancies to a change in productivity?

Part IV

The Medium Run

The long run analysis carried out in Part II focuses on capital accumulation and growth. One can think about the long run as referencing frequencies of time measured in decades. In the medium run, we think about frequencies of time measured in periods of several years, not decades. Over this time horizon, investment is an important component of fluctuations in output, but the capital stock can be treated as approximately fixed. Prices and wages are assumed to be completely flexible.

Our main model for conducting medium run analysis is the neoclassical model. The building blocks of the neoclassical model are the microeconomic decision rules discussed in Part III. In this section we take these decision rules as given and focus on a graphical analysis of the model. This part ought to be self-contained, and can be studied without having worked through Part III.

Chapter 17 lays out the decision rules which characterize the equilibrium of the neoclassical model. Some intuition for these decision rules is presented, and some references are made to the microeconomic analysis from Part III. In Chapter 17 we define several curves and that will be used to analyze the model. In Chapter 18 we graphically analyze how changes in the different exogenous variables of the model impact the endogenous variables of the model. Chapter 19 looks at the data on fluctuations in the endogenous variables of the model and analyzes whether the neoclassical model can qualitatively make sense of the data, and, if so, which exogenous variable must be the main driving force in the model. The neoclassical model as presented here is sometimes called the real business cycle model, or RBC model for short. In Chapter 21 we discuss policy implications of the model. In the neoclassical model the equilibrium is efficient, which means that there is no justification for activist economic policies. In this chapter we also include a discussion of some criticisms of the neoclassical / real business cycle paradigm, particularly as it relates to economic policy. Chapter 22 considers an open economy version of the neoclassical model.

Chapter 17

The Neoclassical Model

The principal actors in the neoclassical model are households, firms, and a government. As is common in macroeconomics, we use the representative agent assumption and posit the existence of one representative household and one representative firm. The household and firm are price-takers in the sense that they take prices as given. A strict interpretation of this assumption is that all households and firms are identical, and that there are a large number of them. A weaker interpretation permits some heterogeneity but assumes a micro-level asset market structure that ensures that households and firms behave the same way in response to changes in exogenous variables, even if they have differing levels of consumption, production, etc. We assume that there are two periods – period t is the present and period $t + 1$ is the future. It is straightforward to extend the model to include multiple periods.

The sections below discuss the decision rules of each actor and the concept of equilibrium. The microeconomic underpinning of the decision rules are derived in Part III. After presenting the decision rules and market-clearing conditions, we develop a set of graphs that allows one to analyze the effects of changes in exogenous variables on the endogenous variables of the model.

17.1 Household

There is a representative household who consumes, saves, holds money, and supplies labor. The household supplies labor to the representative firm at some nominal wage W_t , and buys back goods to consume at a price of P_t dollars. The household can save some of its income through the purchase of bonds. One dollar saved in a bond pays out $1 + i_t$ dollars in the future.

What is relevant for household decision-making are real prices, not nominal prices. Let $w_t = W_t/P_t$ be the real wage. The real price of consumption is simply 1 (i.e. P_t/P_t). The real interest rate is $r_t = i_t - \pi_{t+1}^e$, where π_{t+1}^e is the expected growth rate of the price level between t and $t + 1$. We assume that expected inflation is exogenous. This expression for the real interest rate in terms of the nominal rate is known as the Fisher relationship. C_t is the amount of consumption the household does in period t . Y_t is aggregate income. Assume that

the household pays T_t units of real income to the government in the form of a tax each period. N_t is the labor supplied by the household. M_t is the quantity of money that the household holds. The household's saving is $S_t = Y_t - T_t - C_t$, i.e. its non-consumed income net of taxes.

The decision rules for the household are a consumption function, a labor supply function, and a money demand function. One could also define a saving supply function, but this is redundant with the consumption function. These decision rules are given below:

$$C_t = C^d(Y_t - T_t, Y_{t+1} - T_{t+1}, r_t) \quad (17.1)$$

$$N_t = N^s(w_t, \theta_t) \quad (17.2)$$

$$M_t = P_t M^d(i_t, Y_t) \quad (17.3)$$

The consumption function is given by (17.1). $C^d(\cdot)$ is a function which relates current net income, $Y_t - T_t$; future net income, $Y_{t+1} - T_{t+1}$, and the real interest rate, r_t , into the current level of desired consumption. Why does consumption depend on both current and future net income? The household has a desire to smooth its consumption across time, which is driven by the assumption that the marginal utility of consumption is decreasing in consumption. If the household expects a lot of future income relative to current income, it will want to borrow to finance higher consumption in the present. Likewise, if the household has a lot of current income relative to what it expects about the future, it will want to save in the present (and hence consume less) to provide itself some resources in the future.

Hence, we would expect consumption to be increasing in both current and future net income – i.e. the partial derivatives of the consumption function with respect to the first two arguments, $\frac{\partial C^d(\cdot)}{\partial Y_t}$ and $\frac{\partial C^d(\cdot)}{\partial Y_{t+1}}$, ought to both be positive. While we would expect these partial derivatives to be positive, our discussion above also indicates that we would expect these partial derivatives to always be bound between 0 and 1. If the household gets some extra income in period t , it will want to save part of that extra income so as to finance some extra consumption in the future, which requires increasing its saving (equivalently increasing its period t consumption by less than its income). Likewise, if the household expects some more income in the future, it will want to increase its consumption in the present, but by less than the expected increase in future income – if the household increased its current consumption by more than the increase in future income through borrowing, it would have more than the extra future income to pay back in interest in period $t + 1$, which would mean it could not increase its consumption in period $t + 1$. We will refer to the partial derivative of the consumption function with respect to period t income as the marginal propensity to consume, or MPC for short. It is bound between 0 and 1: $0 < MPC < 1$. While in general a partial derivative is itself a function, we will treat the MPC as a fixed number. The marginal

propensity to save is simply equal to $1 - MPC$: this denotes the fraction of an additional unit of income in period t that a household would choose to save. In terms of the analysis from the Solow model, the MPC would be $1 - s$.

The consumption function depends negatively on the real interest rate, i.e. $\frac{\partial C^d(\cdot)}{\partial r_t} < 0$. Why is this? The real interest rate is the real return on saving – if you forego one unit of consumption in period t , you get back $1 + r_t$ units of consumption in period $t + 1$. The higher is r_t , the more expensive current consumption is in terms of future consumption. We assume that the household's desired saving is increasing in the return on its saving, which means consumption is decreasing in r_t .¹

The labor supply function is given by (17.2). It is assumed that the amount of labor supplied by the household is an increasing function of w_t , i.e. $\frac{\partial N^s(\cdot)}{\partial w_t} > 0$; and an decreasing function of an exogenous variable, θ_t , i.e. $\frac{\partial N^s(\cdot)}{\partial \theta_t} < 0$.² The exogenous variable θ_t represents a labor supply shock, which is meant to capture features which impact labor supply other than the real wage. Real world features which might be picked up by θ_t include unemployment benefits, taxes, demographic changes, or preference changes.

The money demand function is given by (17.3). The amount of money that a household wants to hold, M_t , is proportional to the price level, P_t . Since money is used to purchase goods, the more expensive goods are in terms of money, the more money the household will want to hold. The demand for money is assumed to be decreasing in the nominal interest, i.e. $\frac{\partial M^d(\cdot)}{\partial i_t}$; and increasing in the level of income, $\frac{\partial M^d(\cdot)}{\partial Y_t}$. Money is increasing in income because the more income a household has, the more consumption it wants to do, and therefore it needs more money. Money demand depends on the nominal interest rate because holding money means not holding bonds, which pay nominal interest of i_t . The higher is this interest rate, the less attractive it is to hold money – you'd rather keep it in an interest-bearing account. Money demand depends on the nominal interest rate, rather than the real interest rate, because the relevant tradeoff is holding a dollar worth of money or putting a dollar in an interest-bearing account (whereas the real interest rate conveys information about the tradeoff between giving up a unit of consumption in the present for consumption in the future). Using the Fisher relationship between nominal and real interest rates, $r_t = i_t - \pi_{t+1}^e$, however, the money demand function can be written in terms of the real interest rate and expected inflation:

$$M_t = P_t M^d(r_t + \pi_{t+1}^e, Y_t) \quad (17.4)$$

¹Technically, the assumption here is that the substitution effect of a higher r_t dominates the income effect, as discussed in Chapter 9.

²Technically, that labor supply is increasing in the real wage requires that the substitution effect of a higher wage be stronger than the income effect, as discussed in Chapter 12.

17.2 Firm

There is a representative firm that produces output using capital and labor. We abstract from exogenous labor augmenting productivity, but there is a neutral productivity shifter which is exogenous. The production function is:

$$Y_t = A_t F(K_t, N_t) \quad (17.5)$$

Y_t denotes the output produced by the firm in period t . K_t is the capital stock, which is predetermined and hence exogenous within a period. N_t is the amount of labor used in production. A_t is the exogenous productivity shock which measures the efficiency with which inputs are turned into output. $F(\cdot)$ is an increasing and concave function in capital in labor. Mathematically, this means that $F_K(\cdot) > 0$ and $F_N(\cdot) > 0$ (i.e. the marginal products of capital and labor are both positive, so more of either input leads to more output); $F_{KK}(\cdot) < 0$ and $F_{NN}(\cdot) < 0$ (the second derivatives being negative means that there are diminishing marginal returns – having more K_t or N_t increases output but at a decreasing rate). We also assume that $F_{NK} > 0$. The cross-partial derivative being positive means that the marginal product of capital is higher the more labor input there is (equivalently the marginal product of labor is higher the more capital there is). This just means that one factor of production is more productive the more of the other factor a firm has. The Cobb-Douglas production function used in Part II has these properties.

The firm hires labor on a period-by-period basis at real wage w_t (equivalently at nominal wage W_t , which when divided by the price of goods is the real wage). The firm inherits the current capital stock from past investment decisions; hence K_t is exogenous within period t . It can do investment, I_t , so as to influence its future capital stock. The stock of capital evolves according to:

$$K_{t+1} = I_t + (1 - \delta)K_t \quad (17.6)$$

Equation (17.6) says that the firm's capital stock in the next period depends on (i) its non-depreciated current capital stock, $(1 - \delta)K_t$, where δ is the depreciation rate, and (ii) its investment, I_t . The firm must borrow from a financial intermediary to finance its investment in period t . The real interest rate it faces is r_t , which is the same interest rate at which the household saves.

The decision rules for the firm are a labor demand function and an investment demand function. These are given below:

$$N_t = N^d(w_t, A_t, K_t) \quad (17.7)$$

$$I_t = I^d(r_t, A_{t+1}, K_t) \quad (17.8)$$

The labor demand curve is given by (17.7). Labor demand is decreasing in the real wage, $\frac{\partial N^d(\cdot)}{\partial w_t} < 0$; increasing in current productivity, $\frac{\partial N^d(\cdot)}{\partial A_t} > 0$; and increasing in the current capital stock, $\frac{\partial N^d(\cdot)}{\partial K_t} > 0$. What is the intuition for the signs of these partial derivatives? As discussed in depth in Chapter 12, a profit-maximizing firm wants to hire labor up until the point at which the real wage equals the marginal product of labor. If the real wage is higher, the firm needs to adjust labor input so as to equalize the marginal product with the higher wage. Since the marginal product of labor is decreasing in N_t (i.e. $F_{NN}(\cdot) < 0$), this necessitates reducing N_t when w_t goes up. An increase in A_t makes the firm want to hire more labor. The higher A_t raises the marginal product of labor. For a given real wage, N_t must be adjusted so as to equalize the marginal product of labor with the same real wage. Given $F_{NN}(\cdot) < 0$, this necessitates increasing N_t . The logic for why N_t is increasing in K_t is similar. If K_t is higher, then the marginal product of labor is bigger given our assumption that $F_{KN} > 0$. To equalize a higher marginal product of labor with an unchanged real wage, N_t must increase when K_t goes up.

The investment demand function is given by (17.8). The demand for investment is decreasing in the real interest rate, $\frac{\partial I^d(\cdot)}{\partial r_t} < 0$; increasing in the *future* level of productivity, $\frac{\partial I^d(\cdot)}{\partial A_{t+1}} > 0$; and decreasing in the current capital stock, $\frac{\partial I^d(\cdot)}{\partial K_t} < 0$. To understand why investment depends on these variables in the way that it does, it is critical to understand that investment is *forward-looking*. The benefit of investment in period t is more capital in period $t + 1$. The cost of investment is interest which must be paid back in the future. Hence, investment (like saving for a household) is about giving something up in exchange for something in the future. Investment depends negatively on r_t because the real interest rate is the cost of borrowing by the firm. The higher is r_t , the higher is the cost of current investment. Hence, the demand for investment is decreasing in r_t . Investment demand depends on the future level of productivity, A_{t+1} . Investment demand does not directly depend on current productivity, A_t . The reason for this is that investment influences the *future* level of capital, and hence the *future* level of productivity is what is relevant when choosing current investment. Finally, investment demand is decreasing in its current capital stock. As discussed in Chapter 12, a firm has an optimal target level of K_{t+1} which is independent of its current K_t . This means that the amount of current K_t it has will influence how much investment it must do to reach this target level of future capital. So, for example, if a hurricane comes and wipes out some of a

firm's existing capital, it will want to do more investment – the hurricane doesn't affect the firm's target level of future capital, but it means that the firm needs to do more investment to reach this target capital stock.

17.3 Government

There exists a government that consumes some private output (what we call “government spending”) in both period t and $t + 1$, G_t and G_{t+1} . The government finances its spending with a mix of taxes, T_t and T_{t+1} , and by issuing debt. The amount of spending that the government does in period t , and the amount it expects to do in the future, are both exogenous to the model.³ Though we do not explicitly model any benefit from government spending, we could do so by assuming that the representative household gets a utility flow from government spending.

As discussed in Chapter 13, we assume that something called *Ricardian Equivalence* holds in the model. Ricardian Equivalence states that all that matters for the equilibrium behavior in the economy are the current and future values of government spending, G_t and G_{t+1} . Conditional on current and expected spending, the timing and amounts of taxes, T_t and T_{t+1} , are irrelevant for decision-making, as is the level of debt issued by the government. The basic intuition for Ricardian equivalence is straightforward. If the government runs a deficit in period t (i.e. $G_t > T_t$, so that its expenses are more than its revenue, which could occur because spending is high, taxes are low, or transfer payments are high), it will have to run a surplus in period $t + 1$ to pay off the debt carried over from period t . The household is forward-looking and cares only about the present value of its net income. The timing of tax collection has no impact on the present value of net income, given that taxes are lump sum (i.e. do not affect prices relevant to the household and firm).

The implication of Ricardian Equivalence is that we can act as though the government balances its budget each period, with $G_t = T_t$ and $G_{t+1} = T_{t+1}$. Agents will behave this way whether the government does in fact balance its budget or not. This greatly simplifies the model, as we do not need to worry about T_t , T_{t+1} , or the amount of debt issued by the government. We can re-write the household's consumption function, (17.1), by replacing the tax terms with government spending:

³In practice, the term “government expenditure” means something different than “government spending.” Government spending refers to expenditure on *goods and services* (i.e. roads, police, fire departments, military, etc.). A significant fraction of government expenditure in developed economies also includes *transfer payments* – things like Social Security payments, Medicare, etc.. These transfer payments are not direct expenses on new goods and services – they are transfers to households who then use the income to purchase goods and services. Therefore, in the context of our model transfer payments show up as negative taxes, not positive spending.

$$C_t = C^d(Y_t - G_t, Y_{t+1} - G_{t+1}, r_t) \quad (17.9)$$

The government also decides how much money to supply, M_t . We assume that money supply is exogenous and therefore abstract from the fact that a significant fraction of the money supply in reality is privately created.

17.4 Equilibrium

Equilibrium is defined as a set of prices and quantities where (i) all agents are behaving optimally, taking prices as given, and (ii) all markets simultaneously clear. Markets clearing means that total income is equal to total expenditure which equals production. In our model, this means that: $Y_t = C_t + I_t + G_t$ (income equals expenditure) and $Y_t = A_t F(K_t, N_t)$ (income equals production).

$$C_t = C^d(Y_t - G_t, Y_{t+1} - G_{t+1}, r_t) \quad (17.10)$$

$$N_t = N^s(w_t, \theta_t) \quad (17.11)$$

$$N_t = N^d(w_t, A_t, K_t) \quad (17.12)$$

$$I_t = I^d(r_t, A_{t+1}, K_t) \quad (17.13)$$

$$Y_t = A_t F(K_t, N_t) \quad (17.14)$$

$$Y_t = C_t + I_t + G_t \quad (17.15)$$

$$M_t = P_t M^d(r_t + \pi_{t+1}^e, Y_t) \quad (17.16)$$

$$r_t = i_t - \pi_{t+1}^e \quad (17.17)$$

Expressions (17.10)-(17.17) mathematically summarize the neoclassical model. There are eight equations and eight endogenous variables. The endogenous variables are $Y_t, C_t, I_t, N_t, r_t, w_t, P_t$, and i_t . The exogenous variables are $A_t, A_{t+1}, G_t, G_{t+1}, \theta_t, M_t$, and π_{t+1}^e .

A useful insight is that the first six equations hold independently of any reference to nominal variables (M_t, P_t, i_t , or π_{t+1}^e). We will refer to these six equations as the “real block” of the model. There are also six endogenous variables in this block of equations – Y_t, C_t, I_t, N_t, w_t , and r_t – four quantities and two real prices. That the real variables of the model can be determined without reference to the nominal variables is known as the *classical dichotomy*. We will refer to the last two equations (the money demand function and the Fisher relationship relating real to nominal variables) as the “nominal block” of the model.

These expressions do depend on real variables – r_t and Y_t – but also feature two nominal endogenous variables (P_t and i_t).

17.5 Graphing the Equilibrium

We would like to graphically analyze equations (17.10)-(17.17). In doing so, we will split the equations up into the real and nominal block, focusing first on the real block of equations, (17.10)-(17.15).

17.5.1 The Demand Side

Focus first on the consumption function, (17.10), the investment demand function, (17.13), and the aggregate resource constraint, (17.15). These equations summarize the demand side of the model, since the sum of demand by different actors (the household, the firm, and the government) must equal total demand (the aggregate resource constraint).

We will graphically summarize these equations with what is known as the “IS Curve.” “IS” stands for “investment=saving,” and is simply an alternative way to represent the aggregate resource constraint. To see this, add and subtract T_t from the right hand side of (17.15):

$$Y_t = C_t + T_t + I_t + G_t - T_t \quad (17.18)$$

This can be re-arranged as follows:

$$Y_t - T_t - C_t + T_t - G_t = I_t \quad (17.19)$$

The term $Y_t - T_t - C_t$ is the saving of the household, or S_t^{pp} . The term $T_t - G_t$ is the saving of the of the government, or S_t^g . The sum of their saving is aggregate saving, which must equal investment.

The IS curve summarizes the combinations of (r_t, Y_t) for which the aggregate resource constraint holds where the household and firm choose consumption and investment optimally. Mathematically, the IS curve is given by:

$$Y_t = C^d(Y_t - G_t, Y_{t+1} - G_{t+1}, r_t) + I^d(r_t, A_{t+1}, K_t) + G_t \quad (17.20)$$

Taking the relevant exogenous variables ($G_t, G_{t+1}, A_t, A_{t+1}$, and K_t) as given, and treating Y_{t+1} as given as well (we will return to this issue in the next chapter), this is one equation in two unknowns – r_t and Y_t . The IS curve simply summarizes the different values of r_t and Y_t where (17.20) holds.

To graph the IS curve, let us define an intermediate variable, denoted Y_t^d . This stands for aggregate desired expenditure. Aggregate desired expenditure is the sum of desired expenditure by each agent in the economy:

$$Y_t^d = C^d(Y_t - G_t, Y_{t+1} - G_{t+1}, r_t) + I^d(r_t, A_{t+1}, K_t) + G_t \quad (17.21)$$

Aggregate desired expenditure, Y_t^d , is a function of aggregate income, Y_t . We can plot this as a graph as follows. We assume that when current income is zero, i.e. $Y_t = 0$, aggregate desired expenditure is nevertheless positive, $Y_t^d > 0$. As income increases, aggregate desired expenditure increases because consumption is increasing in income. Because we assume that the MPC is less than one, then a plot of aggregate desired expenditure against aggregate income is just an upward-sloping line, with a positive intercept and a slope less than one. This can be seen in Figure 17.1 below. We will refer to the plot of desired aggregate expenditure against aggregate income as the “expenditure line.”

Figure 17.1: Desired Expenditure and Income

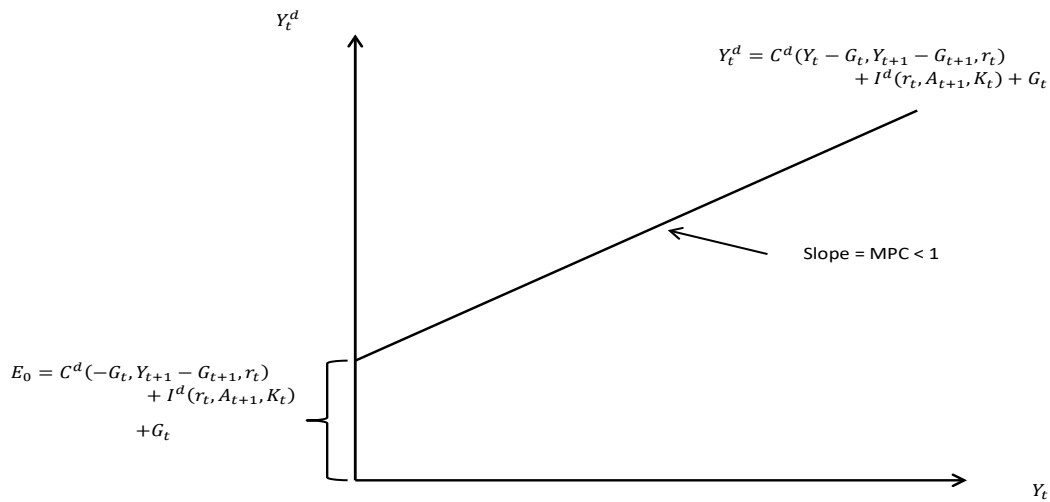

The vertical axis intercept, which is what desired expenditure would be with no current income, i.e. $Y_t = 0$, is assumed to be positive. The level of desired expenditure which is independent of current income is sometimes called “autonomous expenditure.” Denote this:

$$E_0 = C^d(-G_t, Y_{t+1} - G_{t+1}, r_t) + I^d(r_t, A_{t+1}, K_t) + G_t \quad (17.22)$$

Autonomous expenditure, E_0 , is simply the consumption function evaluated at $Y_t = 0$, plus desired investment plus government spending. The level of autonomous expenditure depends on several variables. First, it depends on the real interest rate, r_t . If r_t goes down,

consumption and investment will both increase for a given level of income. This has the effect of increasing the vertical axis intercept and shifting the desired expenditure line up. This is shown in Figure 17.2 below. The exogenous variables which impact desired consumption and investment also will cause the expenditure line to shift. We will discuss these effects below.

Figure 17.2: Desired Expenditure and Income

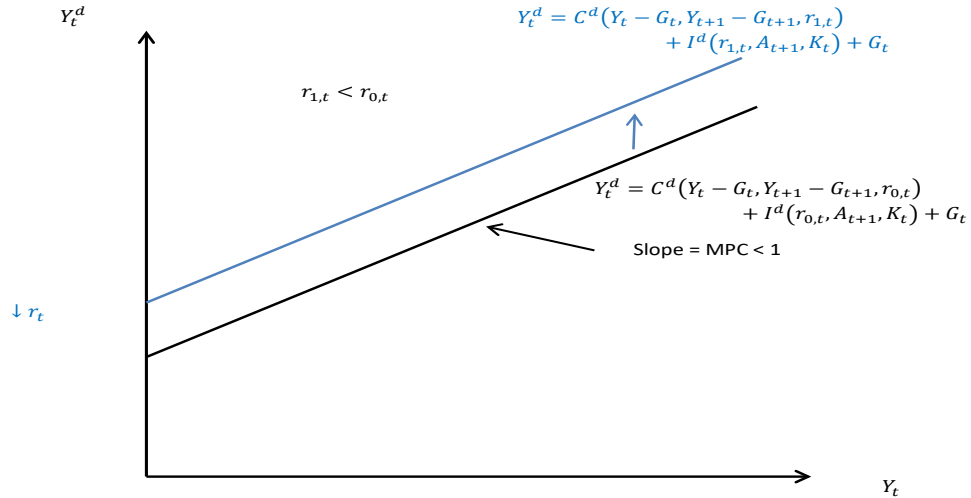

In equilibrium, expenditure must equal income, $Y_t^d = Y_t$. We can graphically find the equilibrium level of Y_t by drawing a 45 degree line, showing all points where $Y_t^d = Y_t$, and finding the Y_t where the expenditure line crosses the 45 degree line. This is shown in Figure 17.3 below. The 45 degree line starts “below” the expenditure line, since it begins in the origin and we assume that the expenditure line has a positive vertical intercept. Since the 45 degree line has a slope of 1, while the expenditure line has a slope less than 1 (since $MPC < 1$), graphically these lines must cross exactly once. At this point, labeled $Y_{0,t}$, income is equal to expenditure.

Figure 17.3: Desired Expenditure and Income: Expenditure Equals Income

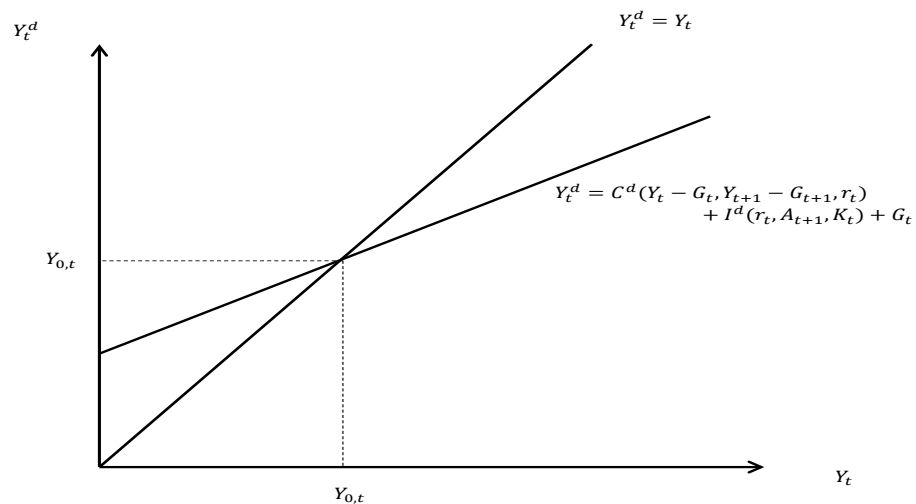

We can derive the IS curve graphically as follows. Draw two graphs on top of the other – the upper graph is the graph of the expenditure line, while the bottom graph has r_t on the vertical axis and Y_t on the horizontal axis. Thus, the horizontal axes are the same in the upper and lower graphs. This is shown in Figure 17.4. Start with some arbitrary real interest rate, $r_{0,t}$, holding all other exogenous variables fixed. This determines a value of autonomous spending (i.e. the vertical intercept of the expenditure line). Find the value of income where the expenditure line crosses the 45 degree line. Call this $Y_{0,t}$. Hence, $(r_{0,t}, Y_{0,t})$ is an (r_t, Y_t) pair where income equals expenditure, taking the exogenous variables as given. Next, consider a lower value of the interest rate, call it $r_{1,t}$. This leads the household and firm to desire more consumption and investment, respectively. This results in the expenditure line shifting up, shown in green in Figure 17.4. This expenditure line crosses the 45 degree line at a higher value of income, call it $Y_{1,t}$. Hence, $(r_{1,t}, Y_{1,t})$ is an (r_t, Y_t) pair where income equals expenditure. Next, consider a higher interest rate, $r_{2,t}$. This reduces desired consumption and investment for any level of Y_t , therefore shifting the expenditure line down, shown in red in Figure 17.4. This expenditure line crosses the 45 degree line at a lower level of income, call it $Y_{2,t}$. Hence, $(r_{2,t}, Y_{2,t})$ is an (r_t, Y_t) pair where income equals expenditure. If we connect the (r_t, Y_t) pairs in the lower graph, we have the IS curve.

Figure 17.4: The IS Curve: Derivation

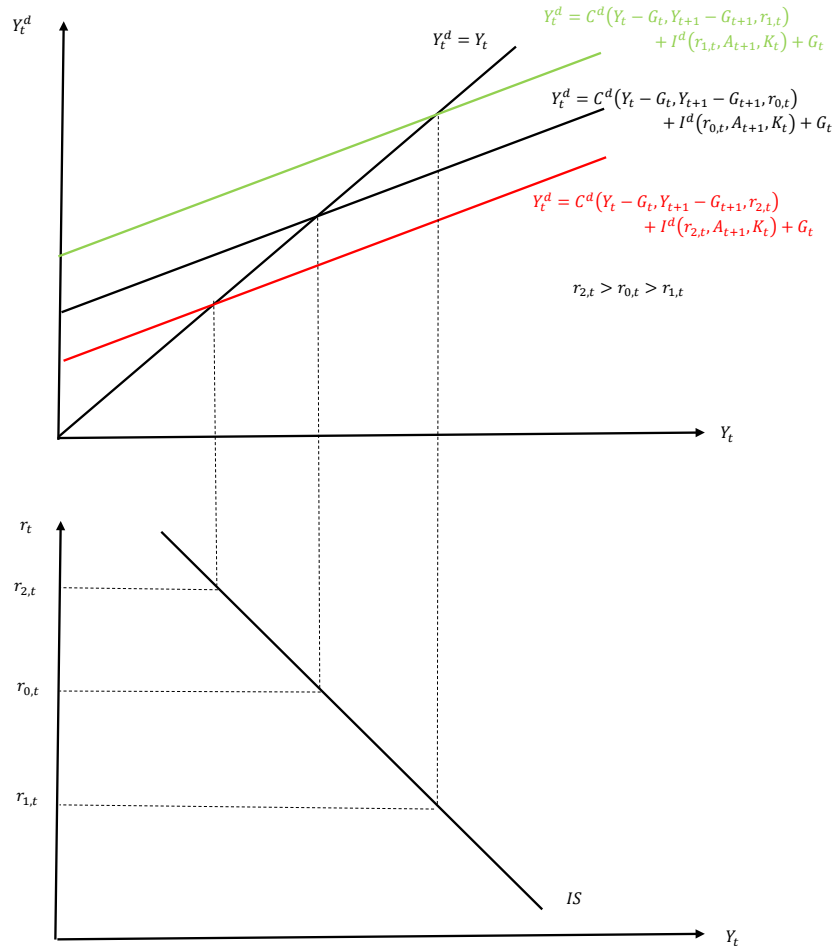

The IS curve is drawn holding the values of exogenous variables fixed. The exogenous variables which are relevant are G_t , G_{t+1} , A_{t+1} , and K_t . Changes in these exogenous variables will cause the IS curve to shift, as we will see in the next chapter.

17.5.2 The Supply Side

The supply side of the economy is governed by the aggregate production function, (17.14), the labor supply curve, (17.11), and the labor demand curve, (17.12). Taking the exogenous variables A_t , K_t , and θ_t as given, equations (17.11)-(17.12) both holding determines a value of N_t . Given a value of N_t , along with exogenous values of A_t and K_t , the value of Y_t is determined from the production function, (17.15).

We will define the Y^s curve (or “output supply”) as the set of (r_t, Y_t) pairs where all three of these equations hold. Since r_t does not enter the production function directly, and since it affects neither labor demand nor supply under our assumptions, the value of Y_t consistent

with these three equations holding is independent of r_t . In other words, the Y^s curve will be a vertical line in a graph with r_t on the vertical axis and Y_t on the horizontal axis.

To derive this formally, let's use a four part graph. This is shown in Figure 17.5. In the upper left part, we have a graph with w_t on the vertical axis and N_t on the horizontal axis. In this graph we plot labor supply, (17.11), which is upward-sloping in w_t , and labor demand, (17.12), which is downward-sloping in w_t . The intersection of these two curves determines the wage and employment, which we denote $w_{0,t}$ and $N_{0,t}$.

Figure 17.5: The Y^s Curve: Derivation

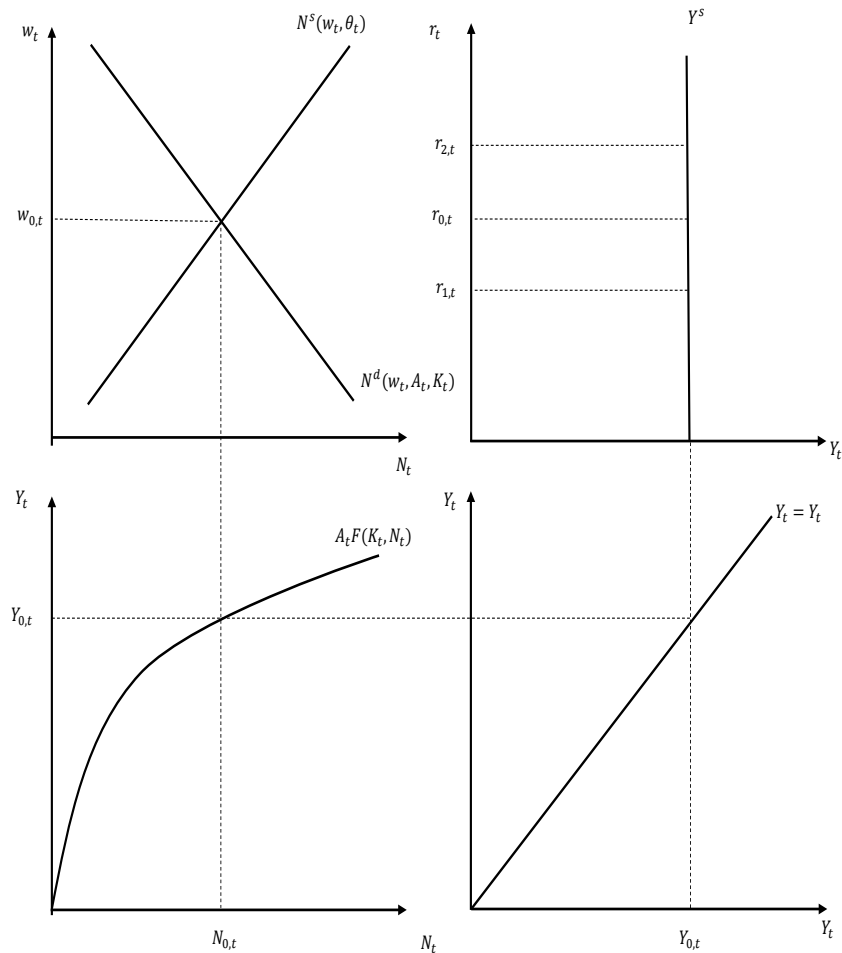

Immediately below the labor market equilibrium graph, we plot the production function, with Y_t against N_t , where N_t is on the horizontal axis. This graph is in the lower left quadrant. The production function is plotted holding A_t and K_t fixed. It starts in the origin and is upward-sloping, but at a diminishing rate, reflecting our assumptions about the production function. Given the value of $N_{0,t}$ where we are on both the labor demand and supply curves, we “bring this down” and evaluate the production function at this value, $N_{0,t}$. This gives us

a value of output, $Y_{0,t}$.

In the lower right quadrant of Figure 17.5, we simply plot a 45 degree line with Y_t on both the horizontal and vertical axes. This is simply a tool to “reflect” the vertical axis onto the horizontal axis. So we “bring over” the value $Y_{0,t}$ from the production function evaluated at $N_{0,t}$, and “reflect” this off of the 45 degree line. We then “bring this up” to the graph in the upper right quadrant, which is a graph with Y_t on the horizontal axis and r_t on the vertical axis. Since r_t affects neither the production function nor the labor market, the value of Y_t is independent of r_t . The Y^s curve is simply a vertical line.

17.5.3 Bringing it all Together

The real block of the economy is summarized by the six equations, (17.10)-(17.11). The IS curve is the set of (r_t, Y_t) pairs where (17.10), (17.13), and (17.15) all hold. The Y^s curve is the set of (r_t, Y_t) pairs where (17.11), (17.12), and (17.14) all hold. All six of the equations holding requires that the economy is simultaneously on both the IS and Y^s curves. Graphically, we can see this below in 17.6.

Figure 17.6: $IS - Y^s$ Equilibrium

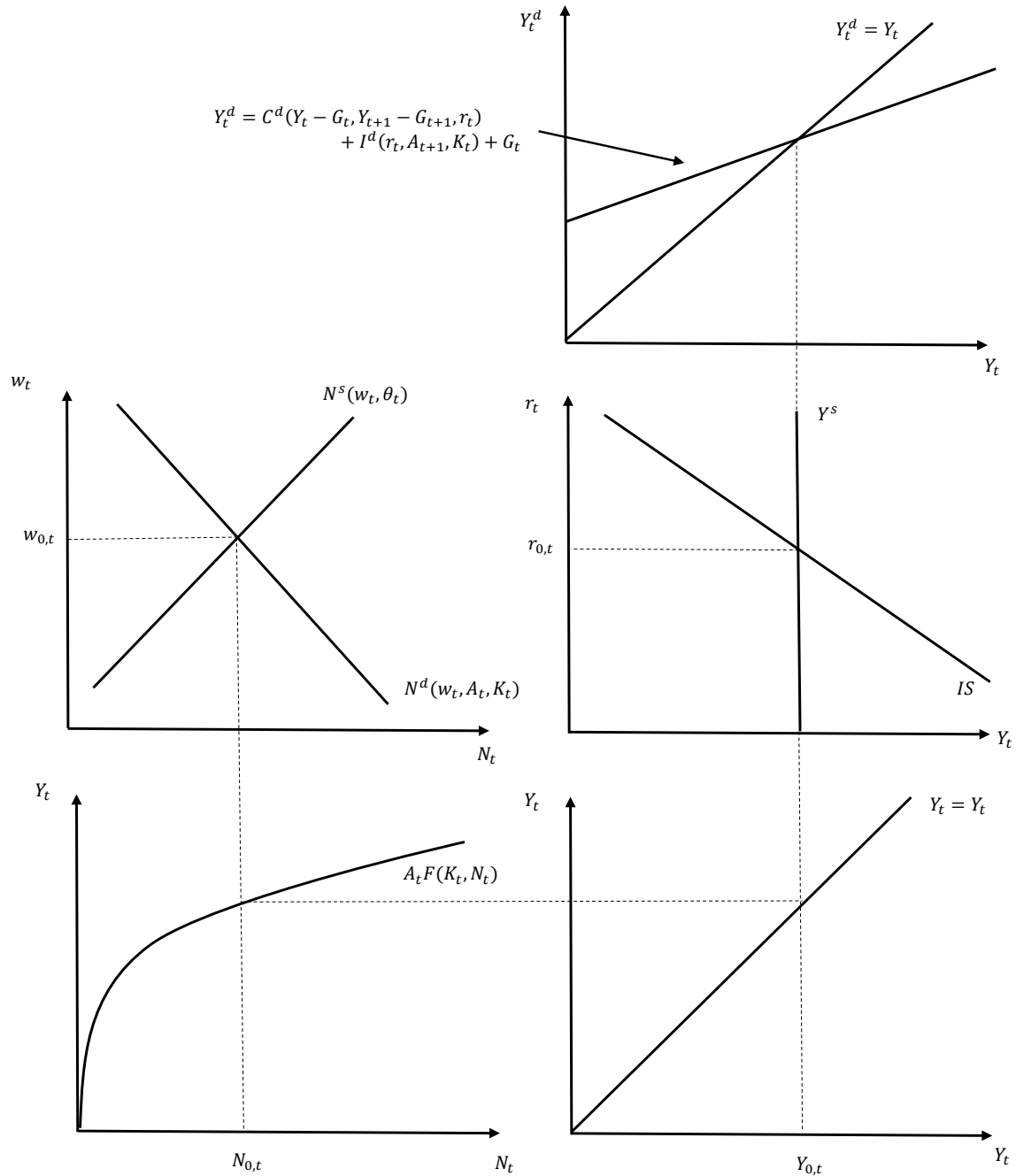

We can use this five part graph to determine the equilibrium values of the real wage, $w_{0,t}$, employment, $N_{0,t}$, output, $Y_{0,t}$, and the real interest rate, $r_{0,t}$. The components of output, in particular consumption and investment, are implicitly determined from the economy being on the IS curve.

17.5.4 The Nominal Side

Once we know the equilibrium values of real endogenous variables, determined graphically in Figure 17.6, we can then turn to the nominal block of the model.

Money demand is summarized by (17.16). The amount of money that a household wants to hold is proportional to the price of goods, P_t , and is a function of the nominal interest rate, which can be written using the Fisher relationship as $r_t + \pi_{t+1}^e$, and the level of current income, Y_t . If we graph this with M_t on the horizontal axis and P_t on the vertical axis, it is an upward-sloping line starting in the origin (intuitively, it starts in the origin because of $P_t = 0$, there is no reason to hold any money). This is shown in Figure 17.7.

Figure 17.7: Money Demand

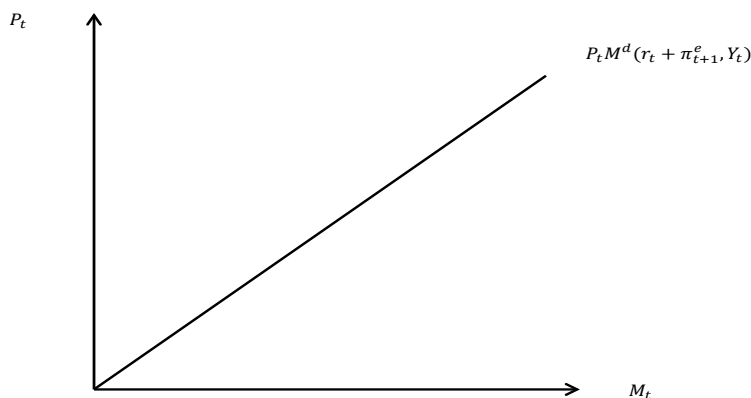

It may strike one as odd to talk about a demand curve that is upward-sloping, as is shown in Figure 17.7. This is because P_t is the price of goods measured in units of money. The price of money, measured in units of goods, is $\frac{1}{P_t}$. If we were to plot money demand as a function of $\frac{1}{P_t}$, as in the left panel of Figure 17.8 below, the demand curve would have its usual, downward slope. Alternatively, sometimes money demand is plotted as a function of the real interest rate. This is shown in the right panel of Figure 17.8. Any of these representations are fine, but we will work with the one shown in Figure 17.7, where the demand curve appears upward-sloping.

Figure 17.8: Money Demand, Alternative Graphical Representations

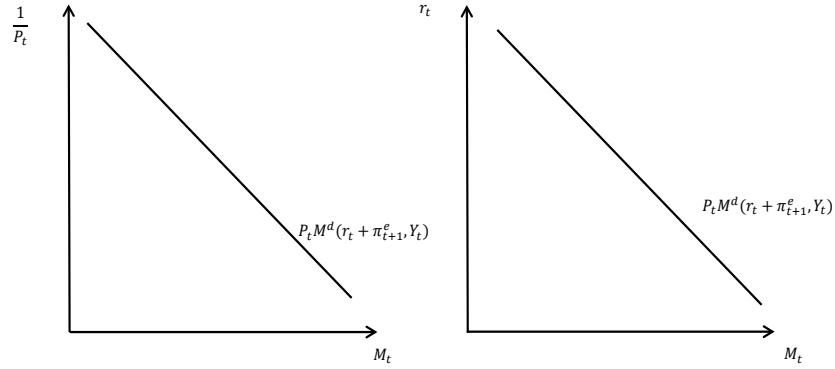

The money supply is set exogenously by the government. Denote this quantity by $M_{0,t}$. In a graph with P_t on the vertical axis and M_t on the horizontal axis, the money supply curve, M^s , is just a vertical line at $M_{0,t}$. This is shown in Figure 17.9.

Figure 17.9: Money Supply

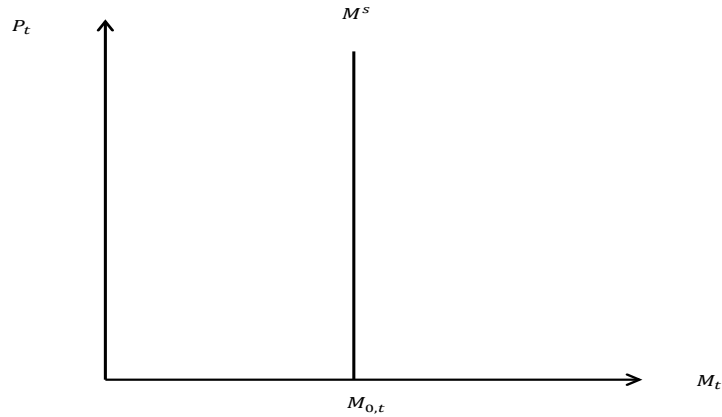

In equilibrium, money demand must equal money supply. The position of the money demand curve depends on the values of the real interest rate and output. These are determined by the intersection of the IS and Y^s curves at $(r_{0,t}, Y_{0,t})$. Given these values, knowing the position of the money demand curve, the equilibrium price level can be determined at the intersection of the money demand and supply curves. This is shown in Figure 17.10 below.

Figure 17.10: Equilibrium in the Money Market

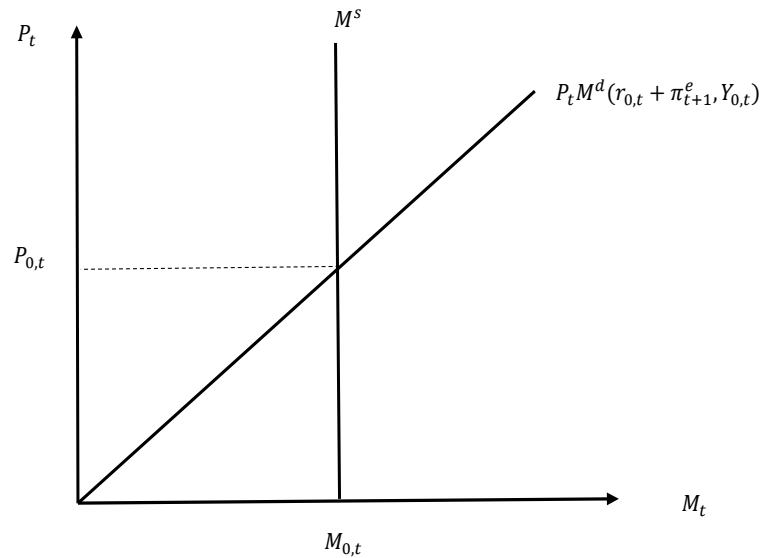

The nominal interest rate is determined given the real interest rate, determined by the intersection of the IS and Y^s curves, and the exogenously given expected rate of inflation.

17.6 Summary

- There are three principal actors in the Neoclassical model: the household, firms, and the government. We assume that there exists a representative household and firm both of which behave as price takers.
- The household's optimization conditions are summarized by a consumption function which relates current consumption to current and future disposable income and the real interest rate; a labor supply function which says that the quantity of hours supplied is increasing in the real wage; and a demand for real money balances.
- The firm's optimization problem is summarized by a labor demand curve and an investment demand curve. Labor demand is positively related to the level of technology and the current capital stock and negatively related to the real wage. Investment demand depends negatively on the real interest rate and current capital stock, but positively on the level of future productivity.
- The government finances itself through lump sum taxes and we assume there are sufficient conditions for Ricardian Equivalence to hold. Consequently, the time path of taxes is irrelevant.

- The IS curve is all the real interest rate / desired spending combinations such that desired spending equals total income.
- The aggregate supply curve is all the real interest rate / output combinations such that households and firms are optimizing and the firm operates on their production function.
- The money demand function is upward sloping in the price level since it is the inverse of the price of money. Money supply is exogenous.

Key Terms

- Marginal propensity to consume
- Ricardian equivalence
- Autonomous expenditure

Questions for Review

1. In words, define the Y^s curve.
2. In words, define the IS curve.
3. Evaluate the following sentence: “Demand curves should slope down. We must have made a mistake in drawing an upward-sloping demand curve for money.”

Exercises

1. This exercise will ask you to work through the derivation of the IS curve under various different scenarios.
 - (a) Graphically derive the IS curve for a generic specification of the consumption function and the investment demand function.
 - (b) Suppose that investment demand is relatively more sensitive to the real interest rate than in (a). Relative to (a), how will this impact the shape of the IS curve?
 - (c) Suppose that the MPC is larger than in (a). How will this affect the shape of the IS curve?
2. Suppose that labor supply were a function of the real interest rate. In particular, suppose that $N_t = N^s(w_t, \theta_t, r_t)$, where $\frac{\partial N^s}{\partial r_t} > 0$.

- (a) Can you provide any intuition for why labor supply might positively depend on the real interest rate?
 - (b) Suppose that labor supply is increasing in the real interest rate. Derive the Y^s curve graphically.
3. **[Excel Problem]** Suppose that we assume specific functional forms for the consumption function and the investment demand function. These are:

$$C_t = c_1(Y_t - G_t) + c_2(Y_{t+1} - G_{t+1}) - c_3r_t \quad (17.23)$$

$$I_t = -d_1r_t + d_2A_{t+1} + d_3K_t \quad (17.24)$$

Here, c_1 through c_4 and d_1 through d_3 are fixed parameters governing the sensitivity of consumption and investment to different factors relevant for those decisions.

- (a) We must have $Y_t = C_t + I_t + G_t$. Use the given function forms for the consumption and investment with the resource constraint to derive an algebraic expression for the IS curve.
- (b) Use this to derive an expression for the slope of the IS curve (i.e. $\frac{\partial Y_t}{\partial r_t}$).
- (c) Suppose that the parameters are as follows: $c_1 = 0.6$, $c_2 = 0.5$, $c_3 = 10$, $d_1 = 20$, $d_2 = 1$, and $d_3 = 0.5$. Suppose that $Y_{t+1} = 15$, $G_t = 10$, $G_{t+1} = 10$, $A_{t+1} = 5$, and $K_t = 15$. Suppose that $r_t = 0.1$. Create an Excel file to numerically solve for Y_t .
- (d) Suppose instead that $r_t = 0.15$. Solve for Y_t in your Excel file.
- (e) Create a range of values of r_t , ranging from 0.01 to 0.2, with a gap of 0.001 between values. Solve for Y_t for each value of r_t . Create a plot with r_t on the vertical axis and Y_t on the horizontal axis (i.e. create a plot of the IS curve). Is it downward-sloping, as you would expect?
- (f) Create another version of your IS curve when $A_{t+1} = 7$ instead of 5. Plot this along with the IS curve with $A_{t+1} = 5$. Explain how the higher value of A_{t+1} impacts the position of the IS curve.

Chapter 18

Effects of Shocks in the Neoclassical Model

In Chapter 17 we laid out and discussed the decision rules characterizing optimal behavior by the household and firm in the neoclassical model. We also derived a graphical apparatus to characterize the equilibrium. In this chapter, we use this graphical apparatus to analyze the effects of changes in exogenous variables on the endogenous variables of the model.

18.1 Equilibrium

The neoclassical model is characterized by the following equations all simultaneously holding:

$$C_t = C^d(Y_t - G_t, Y_{t+1} - G_{t+1}, r_t) \quad (18.1)$$

$$N_t = N^s(w_t, \theta_t) \quad (18.2)$$

$$N_t = N^d(w_t, A_t, K_t) \quad (18.3)$$

$$I_t = I^d(r_t, A_{t+1}, K_t) \quad (18.4)$$

$$Y_t = A_t F(K_t, N_t) \quad (18.5)$$

$$Y_t = C_t + I_t + G_t \quad (18.6)$$

$$M_t = P_t M^d(r_t + \pi_{t+1}^e, Y_t) \quad (18.7)$$

$$r_t = i_t - \pi_{t+1}^e \quad (18.8)$$

Equations (18.1)-(18.6) comprise the “real block” of the model, while equations (18.7)-(18.8) comprise the “nominal block” of the model. The IS curve summarizes (18.1), (18.4), and (18.6), while the Y^s curve summarizes (18.2), (18.3), and (18.5). Graphically:

Figure 18.1: $IS - Y^s$ Equilibrium

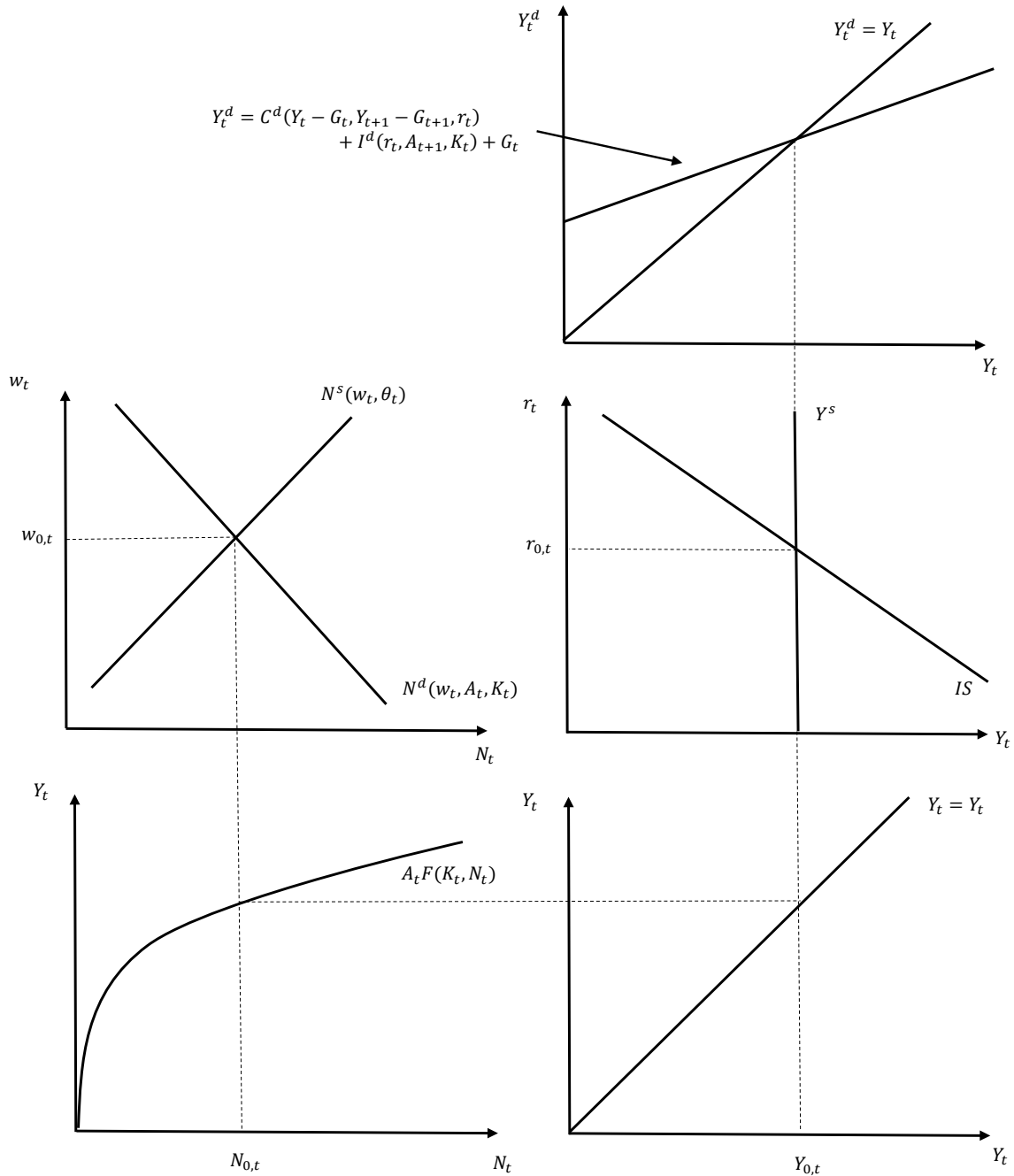

The equilibrium real interest rate and level of output, $r_{0,t}$ and $Y_{0,t}$, are determined at the intersection of the IS and Y^s curves. Once these are known, the position of the money demand curve, which is given by (18.7), is known, and the equilibrium price level can be determined by the intersection of this demand curve with the exogenous quantity of money supplied. This is shown in Figure 18.2.

Figure 18.2: Equilibrium in the Money Market

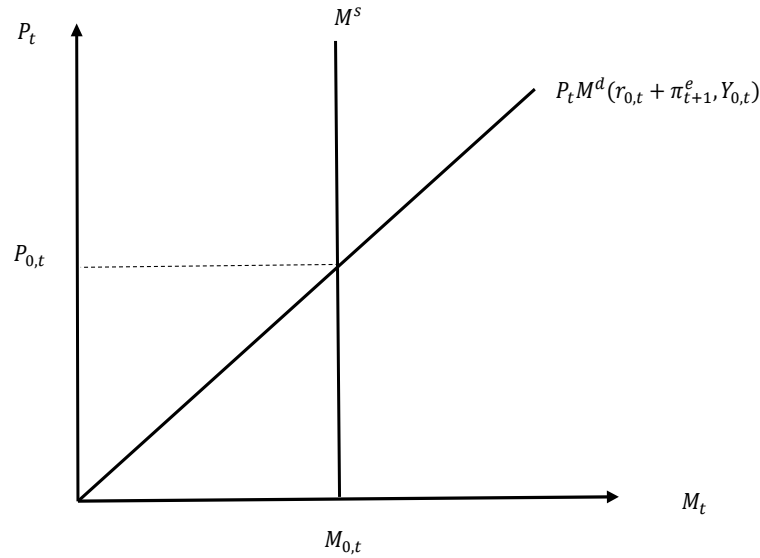

18.2 The Effects of Changes in Exogenous Variables on the Endogenous Variables

The exogenous variables of the model include the current and future levels of productivity, A_t and A_{t+1} ; the current and future levels of government spending, G_t and G_{t+1} ; the current capital stock, K_t ; the value of the labor supply shifter, θ_t ; the quantity of money supplied, M_t ; and the rate of expected inflation, π_{t+1}^e . We will refer to changes in an exogenous variable as “shocks.” Our objective is to understand how the endogenous variables of the model react to different shocks. Some of these shocks will be analyzed in the text that follows, while the remainder are left as exercises.

Focusing on the equations underlying the curves, we can split the shocks into three different categories. A_t and θ_t are supply shocks in that they appear only in the equations underlying the Y^s curve; G_t , G_{t+1} , and A_{t+1} are demand shocks in that they only appear in the equations underlying the IS curve; M_t and π_{t+1}^e are nominal shocks that do not appear in the equations underlying the Y^s or IS curves. K_t is both a demand shock (it influences the amount of desired investment, and hence the IS curve) as well as a supply shock (it influences the amount of output that can be produced given labor). We will not focus on fluctuations in K_t here. While K_t can exogenously decrease (say, due to a hurricane that wipes out some of a country’s capital), it cannot exogenously increase (capital must itself be produced). Thus, fluctuations in K_t are not a candidate source for business cycle fluctuations (defined as increases and decreases in output relative to trend).

There is one potentially thorny issue that bears mentioning here. Current consumption demand depends on expectations of future income, Y_{t+1} . Future income is an endogenous variable. The complication arises because changes in all of the exogenous variables will induce changes in current investment, which would affect the future stock of capital, and hence future output. We will ignore these effects. As noted at the onset of this part of the book, when thinking about the medium run we think about the capital stock as effectively being fixed. While investment will fluctuate in response to shocks, the fluctuations in investment relative to the size of the capital stock will be small, and we can therefore safely ignore the effects of changes in current investment on future capital over a short enough period of time (say a few years). Concretely, our assumption means that we will treat Y_{t+1} as invariant to changes in period t exogenous variables – i.e. we will treat Y_{t+1} as fixed when A_t , G_t , θ_t , or M_t change. We will not treat Y_{t+1} as fixed when expected future exogenous variables change – i.e. we will permit changes in A_{t+1} or G_{t+1} , anticipated in period t , to affect expectations of Y_{t+1} . Change in these variables will impact Y_{t+1} in exactly the same way that changes in the period t versions of these exogenous variables would affect Y_t . As we shall see, changes in π_{t+1}^e will not have any effect on real variables, and so we can treat Y_{t+1} as fixed with respect to π_{t+1}^e as well, even though this variable is dated $t + 1$.

In the subsections below, we work through the effects on the endogenous variables of shocks to each of the exogenous variables. In doing so, we assume that the economy is initially in an equilibrium characterized by a 0 subscript (i.e. the initial equilibrium level of output is $Y_{0,t}$). The new equilibrium, taking into account a change in an exogenous variable, will be denoted by a 1 subscript (i.e. the new equilibrium level of output will be $Y_{1,t}$). We will consider exogenous increases in a subset of exogenous variables; the exercises would be similar, with reversed signs, for decreases.

18.2.1 Productivity Shock: Increase in A_t :

Consider first an exogenous increase in A_t , from $A_{0,t}$ to $A_{1,t}$, where $A_{1,t} > A_{0,t}$. This is a supply side shock, so let's focus on the curves underlying the supply side of the model. An increase in A_t shifts the labor demand curve to the right. This results in a higher level of N_t and a higher w_t , which we denote $w_{1,t}$ and $N_{1,t}$. The higher A_t also shifts the production function up – for a given N_t , the firm produces more Y_t when A_t is higher for given levels of N_t and K_t . If you combine the higher N_t from the labor market with the production function that has shifted up, you get a higher level of Y_t , call it $Y_{1,t}$. Output on the supply side rises for two reasons – the exogenous increase in A_t , and the endogenous increase in N_t . Since the value of Y_t from the supply side is independent of the level of r_t under our assumptions, the

vertical Y^s curve shifts to the right. These effects are shown with the blue lines in Figure 18.3 below.

Figure 18.3: Increase in A_t

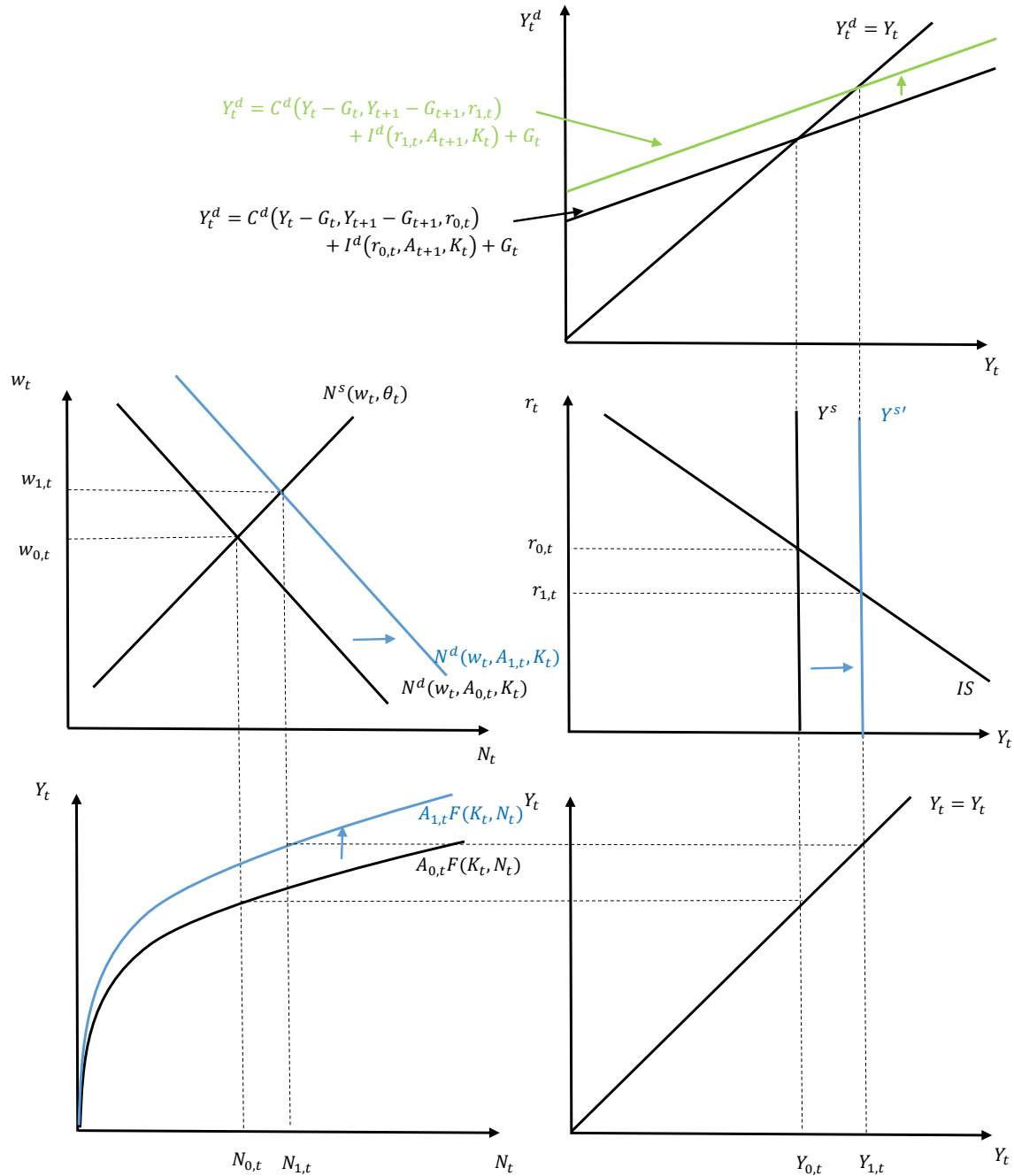

There is no shift of the IS curve. The rightward shift of the Y^s curve, combined with no shift in the IS curve, means that r_t must fall, to $r_{1,t}$. The lower r_t causes the expenditure line to shift up in such a way that income equals expenditure at the new higher level of Y_t .

This is an “indirect” effect of the lower real interest rate, and is hence shown in green in the diagram. Effectively, when A_t goes up, firms produce more output. Since the higher level of output must translate into higher expenditure in equilibrium, the real interest rate must fall, which induces the household to consume more and the firm to invest more. Hence, C_t and I_t both rise. We can think about general equilibrium in the model as being characterized by r_t falling as the economy “moves down” along the IS curve until the point where the economy is on both IS and Y^s curves.

Now, let us examine the effects on nominal endogenous variables. Since π_{t+1}^e is taken to be exogenous, a lower real interest rate translates into a lower nominal interest rate. The lower interest rate leads to an increase in money demand, as does the higher level of income. Hence, the money demand curve shifts out to the right, which is shown in Figure 18.4. With no change in money supply, the price level must fall so that the money market is in equilibrium. Hence, a higher A_t causes P_t and i_t to both fall.

Figure 18.4: Increase in A_t : The Money Market

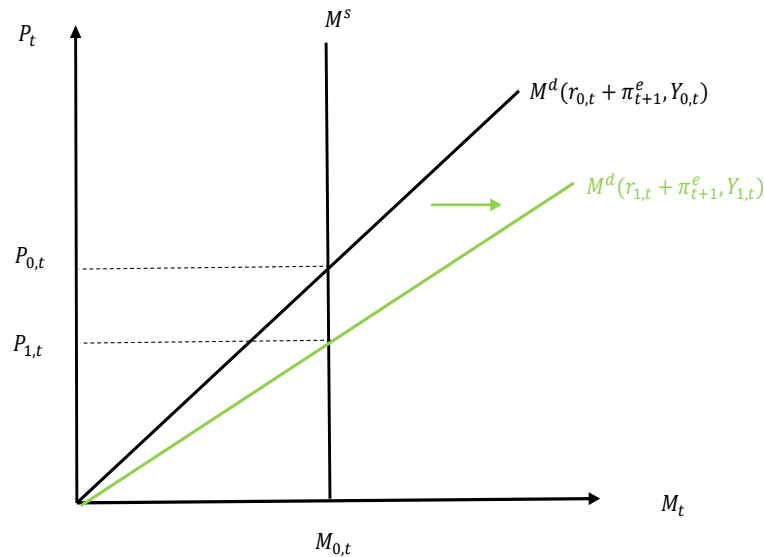

18.2.2 Expected Future Productivity Shock: Increase in A_{t+1}

Suppose that agents in the economy expect the future level of productivity, A_{t+1} , to increase. In the recent academic literature, a shock such as this has come to be called a “news shock.” More generally, we could think about expectations of higher future productivity as representing a wave of optimism or “animal spirits” as Keynes originally coined the term.

A change in A_{t+1} affects the demand side of the model. The supply side in period t only depends on the current level of productivity. There is both a direct and an indirect effect on

current demand. First, higher A_{t+1} makes the firm want to do more investment. Second, an increase in A_{t+1} is like an increase in current productivity from the perspective of period $t + 1$. Hence, Y_{t+1} will rise, as we saw above when analyzing the effects of an increase in current A_t . This will make the household want to consume more in the present as well. Both the increase in desired investment and consumption raise autonomous desired expenditure in period t . This shifts the expenditure line up (shown in blue below) and causes the IS curve to shift out to the right. This is shown in Figure 18.5 below. The higher A_{t+1} raises expectations about future income from $Y_{0,t+1}$ to $Y_{1,t+1}$:

Figure 18.5: Increase in A_{t+1}

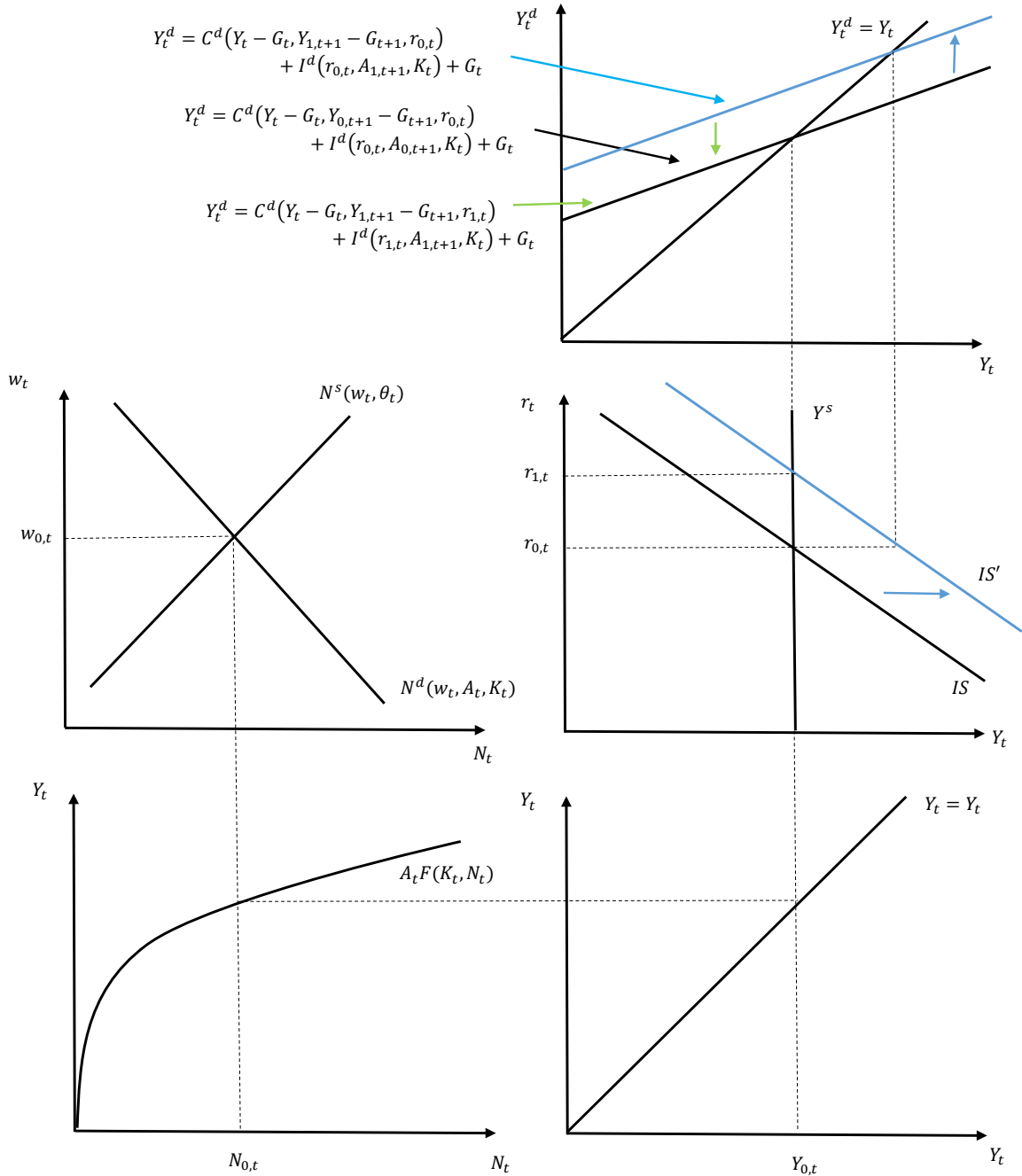

There is no shift in the Y^s curve. Hence, in equilibrium, Y_t is unchanged. The real interest rate must rise. This is demonstrated with the green arrow in the expenditure line graph, where the increase in r_t is sufficient to make the desired expenditure line shift back to where it began. Nothing happens in the labor market. It is ambiguous as to what happens to C_t and I_t . Since G_t is exogenous and Y_t is unchanged, we know that $C_t + I_t$ (what one might

call private expenditure) must be unchanged. r_t being higher works to make both C_t and I_t lower, counteracting the positive effect of the higher A_{t+1} . Which effect dominates for which variable is unclear, so we cannot say with certainty what happens to C_t or I_t . We do know, however, that if C_t rises, I_t must fall (and vice-versa).

Let us turn next to the money market. Since r_t rises and π_{t+1}^e is taken to be exogenous, then i_t must rise as well. Higher r_t works to pivot the money demand curve in. Since Y_t is unaffected, we know that money demand therefore pivots in. Along a stable money supply curve, this means that the price level, P_t , must rise. This is shown in Figure 18.6.

Figure 18.6: Increase in A_{t+1} : The Money Market

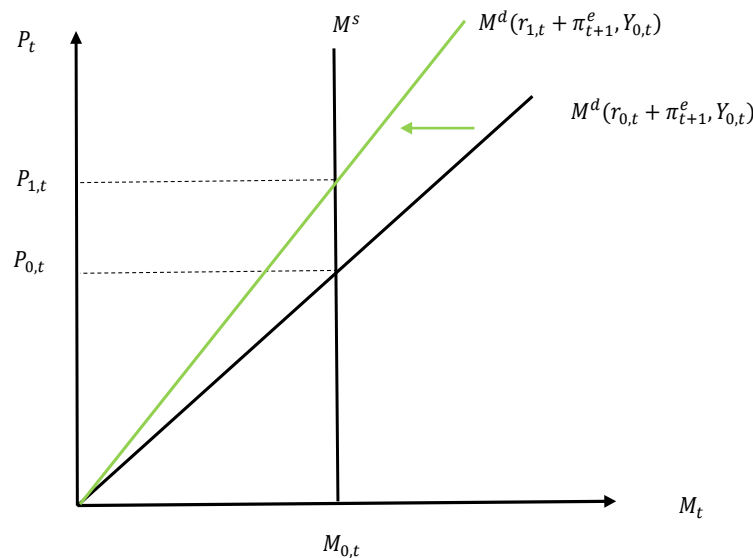

18.2.3 Government Spending Shock: Increase in G_t :

Suppose that there is an exogenous increase in G_t . As noted above, we are here assuming that Ricardian Equivalence holds, so it is irrelevant how this spending increase is financed. The household behaves as though the government fully finances the increase in spending with an increase in current taxes.

G_t is a demand-side shock, and will affect the position of the IS curve. How will it do so? G_t shows up twice in the expressions underlying the IS curve – once directly as an independent component of expenditure, and once indirectly inside the consumption function. The direct effect is positive, whereas the indirect effect is negative. So how is desired expenditure impacted? It turns out that desired expenditure increases for every level of income. This is shown formally in the Mathematical Diversion below. The intuition for it is straightforward. Since the MPC is less than 1, the negative indirect effect of higher G_t (the reduction in

consumption) is smaller than the direct effect (the increase in one of the components of expenditure). Hence, total autonomous expenditure increases, which shifts the IS curve to the right.

Mathematical Diversion

Autonomous expenditure, defined in Chapter 17 in equation (17.22), is total desired expenditure when current income is zero. Formally:

$$E_0 = C^d(-G_t, Y_{t+1} - G_{t+1}, r_t) + I^d(r_t, A_{t+1}, K_t) + G_t \quad (18.9)$$

The partial derivative of E_0 with respect to G_t is:

$$\frac{\partial E_0}{\partial G_t} = -\frac{\partial C^d(\cdot)}{\partial Y_t} + 1 = 1 - MPC \quad (18.10)$$

The first term on the right hand side of (18.10) is the negative of the partial derivative of the consumption function with respect to its first argument, which we denote as $\frac{\partial C^d}{\partial Y_t}$ (the argument is $Y_t - G_t$). This is simply the MPC, which we take to be a constant less than 1. Hence, an increase in G_t raises autonomous expenditure (the vertical intercept of the expenditure line) by $1 - MPC$, which is positive given that the MPC is less than 1.

The increase in G_t therefore raises autonomous expenditure. This means that the expenditure line shifts up for a given r_t , resulting in the IS curve shifting out to the right. These effects are shown in blue in Figure 18.7. A rightward shift of the IS curve with no effect on the Y^s curve means that nothing happens to Y_t , while r_t increases. The increase in r_t reduces autonomous expenditure (both investment and consumption), in such a way that the expenditure line shifts back down to where it began. A higher r_t means that on net I_t is lower. A higher r_t , in conjunction with higher G_t , also means that C_t is lower. There are no effects on labor market variables.

Figure 18.7: Increase in G_t

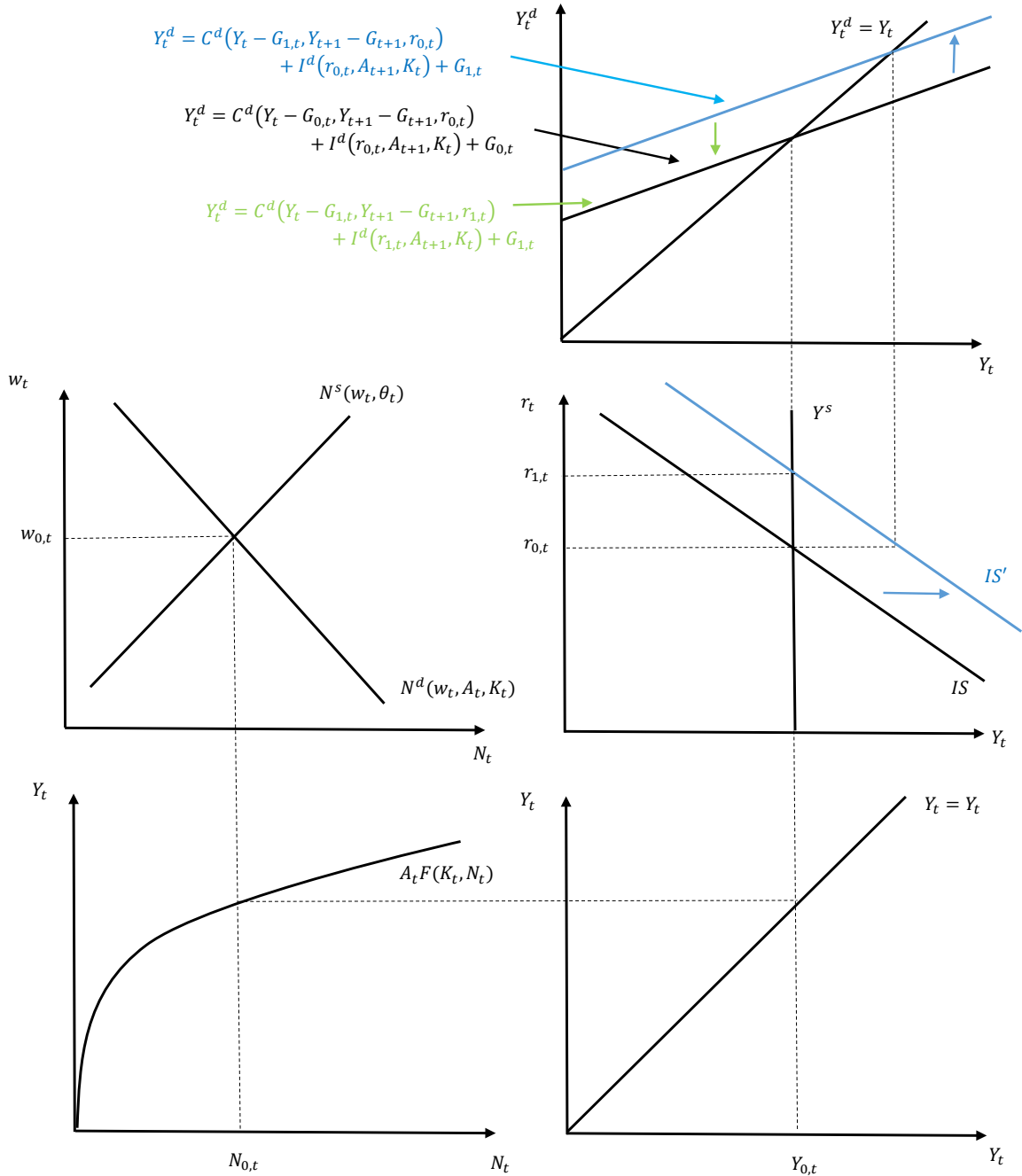

Having determined the effects of an increase in G_t on the real variables of the model, we turn next to the nominal variables. A higher r_t , in conjunction with no change in Y_t , means that the money demand curve pivots in. Along a stable money supply curve, this results in an increase in P_t . Given that we take π_{t+1}^e to be exogenous, the nominal interest rate simply moves in the same direction as the real interest rate.

Figure 18.8: Increase in G_t : The Money Market

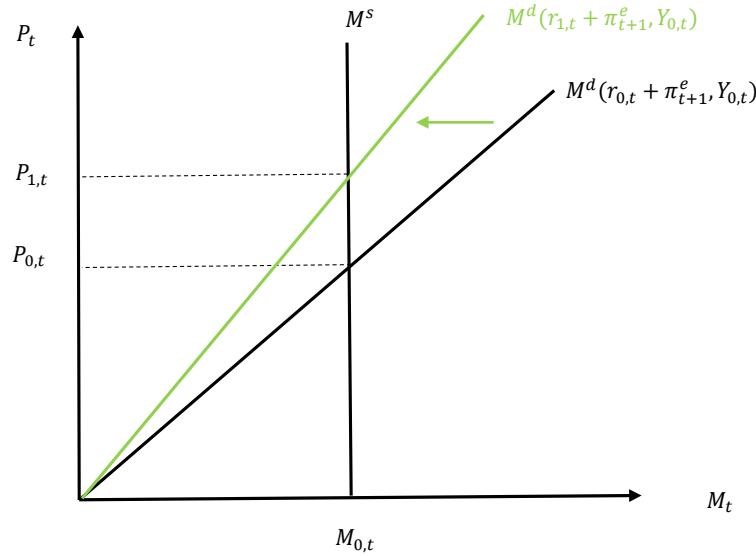

One often hears about the government spending multiplier – how much output changes for a one unit change in government spending. This can be cast in terms of derivatives, or $\frac{dY_t}{dG_t}$. In the neoclassical model under our assumptions concerning labor supply, the government spending multiplier is zero – output does not change.¹ This is a result of our assumption that the supply of output is invariant to G_t – there is no mechanism in this model through which higher G_t could entice the firm to produce more output. On the demand side, a multiplier of zero obtains because the real interest rate rises, which reduces both I_t and C_t sufficiently so that total expenditure remains unchanged. Put a little bit differently, private expenditure is completely “crowded out” by the increase in public expenditure. Crowding out is a term used in economics to refer to the fact that increases in government spending may result in decreases in private expenditure due to equilibrium effects on the real interest rate. In the case of the neoclassical model, crowding out is said to be complete – the reduction in private spending completely offsets the increase in public spending, leaving total expenditure unchanged.

One can derive an expression for the “fixed interest rate multiplier,” or the change in Y_t for a change in G_t , if the real interest rate were held fixed. We can think about this as representing how output would change if the Y^s curve were *horizontal* instead of vertical. For the neoclassical model with Ricardian Equivalence, the fixed interest rate multiplier turns

¹The relevant assumption giving rise to this result is that labor supply only depends on the real wage and the exogenous variable θ_t . Under alternative assumptions about preferences, it could be the case that labor supply is increasing in r_t , and hence the Y^s curve is upward-sloping. Under this assumption, which is laid out in Appendix C, the government spending multiplier will be positive but will nevertheless be less than one.

out to be 1, as is shown formally in the mathematical diversion below. If there were no Ricardian Equivalence, and the increase in government spending were financed with debt as opposed to taxes, the fixed interest rate multiplier would be $\frac{1}{1-MPC} > 1$, which is what is often presented in textbook treatments. This expression for the multiplier only holds if (i) there is no Ricardian Equivalence, (ii) the increase in spending is financed via debt, and (iii) the real interest rate is fixed.

Mathematical Diversion The IS equation can be written mathematically as:

$$Y_t = C^d(Y_t - G_t, Y_{t+1} - G_{t+1}, r_t) + I^d(r_t, A_{t+1}, K_t) + G_t \quad (18.11)$$

Here, this is an implicit function – Y_t appears on both the right and left hand sides. Another term for the total derivative is the “implicit derivative,” which is a way to derive an expression for a derivative of an implicit function. Take the total derivative of (18.11), holding all exogenous variables but G_t fixed:

$$dY_t = \frac{\partial C^d(\cdot)}{\partial Y_t}(dY_t - dG_t) + \frac{\partial C^d(\cdot)}{\partial r_t} dr_t + \frac{\partial I^d(\cdot)}{\partial r_t} dr_t + dG_t \quad (18.12)$$

Now, suppose that r_t is held fixed, so $dr_t = 0$. Denoting $\frac{\partial C^d(\cdot)}{\partial Y_t}$ as MPC, (18.12) can be re-written:

$$dY_t = MPC(dY_t - dG_t) + dG_t \quad (18.13)$$

This can be re-arranged to yield:

$$\frac{dY_t}{dG_t} = 1 \quad (18.14)$$

In other words, the “fixed interest rate” multiplier is 1. In words, what this says is that the IS curve shifts out horizontally to the right one-for-one with an increase in G_t – if r_t were held fixed, Y_t would increase by G_t .

What is the intuition for this result? It is easiest to think about this by thinking about a period being broken into many “rounds” with many different households. The following example hopefully makes this clear. In “round 1,” the government increases spending by dG_t and increases the taxes of a household by the same amount. This increases total expenditure by $(1 - MPC)dG_t$ – the 1 is the direct effect of the expenditure, while the $-MPC$ is the indirect effect from the household

on whom the tax is levied reducing its consumption by the MPC times the change in its take-home income. Since the MPC is less than 1, $(1 - MPC) > 0$, so total expenditure rises in round 1. But that additional expenditure is additional income for a different household. In “round 2,” with $(1 - MPC)dG_t$ extra in income, that household will increase its consumption by $MPC(1 - MPC)dG_t$ – i.e. it will consume MPC of the additional income. Hence, in “round 2,” there is an additional increase in expenditure of $MPC(1 - MPC)dG_t$. But that extra expenditure is income for some other household. In “round 3,” that household will increase its consumption by $MPC \times MPC(1 - MPC)dG_t$, or the MPC times the extra income generated from the previous round. This process continues until there is no additional expenditure. Formally, we can summarize the effect on expenditure in each round as:

$$\begin{aligned}
 \text{Round 1} &= (1 - MPC)dG_t \\
 \text{Round 2} &= MPC(1 - MPC)dG_t \\
 \text{Round 3} &= MPC^2(1 - MPC)dG_t \\
 \text{Round 4} &= MPC^3(1 - MPC)dG_t \\
 &\vdots \\
 \text{Round } j &= MPC^{j-1}(1 - MPC)dG_t
 \end{aligned}$$

The total change in income/expenditure is the sum of changes from each “round,” or:

$$dY_t = (1 - MPC)dG_t [1 + MPC + MPC^2 + MPC^3 + \dots] \quad (18.15)$$

Using the formula for an infinite sum derived in Appendix A, the term inside brackets is equal to $\frac{1}{1 - MPC}$. The MPC’s cancel, and one gets $dY_t = dG_t$.

Suppose that we instead assumed that consumption was not forward-looking and that Ricardian Equivalence did not hold. In particular, suppose that the consumption function is given by:

$$C_t = C^d(Y_t - T_t, r_t) \quad (18.16)$$

In (18.16), consumption depends only on current net income and the real interest rate. Since consumption is not forward-looking, Ricardian Equivalence does not necessarily hold, and we cannot act as though $T_t = G_t$. With this consumption function, the mathematical expression for the IS curve is given by:

$$Y_t = C^d(Y_t - T_t, r_t) + I^d(r_t, A_{t+1}, K_t) + G_t \quad (18.17)$$

Totally differentiate (18.17):

$$dY_t = \frac{\partial C^d(\cdot)}{\partial Y_t}(dY_t - dT_t) + \frac{\partial C^d(\cdot)}{\partial r_t}dr_t + \frac{\partial I^d(\cdot)}{\partial r_t}dr_t + dG_t \quad (18.18)$$

Now, re-label the partial derivative of the consumption function with respect to its first argument as MPC , and suppose that the real interest rate is held fixed. (18.18) can be written:

$$dY_t = MPCdY_t - MPCdT_t + dG_t \quad (18.19)$$

Now, suppose that the government spending increase is “tax financed,” so that $dT_t = dG_t$ (i.e. taxes increase by the same amount as the increase in spending). Then (18.19) reduces to the same expression in the Ricardian Equivalence case, (18.14). But suppose that the increase in spending is “deficit financed,” so that $dT_t = 0$. Then, (18.19) reduces to:

$$\frac{dY_t}{dG_t} = \frac{1}{1 - MPC} \quad (18.20)$$

Since the MPC is less than 1, this expression is greater than 1. In other words, without Ricardian Equivalence, a deficit-financed increase in government spending raises output by a multiple of the initial increase in spending. Note that this expression only holds if r_t is fixed. Were we to incorporate a consumption function like (18.16) into the model, the government spending multiplier in equilibrium would still be 0 – r_t would rise to completely crowd out private expenditure given our assumptions about the supply side of the economy. Compared to the Ricardian equivalence case, r_t would have to rise more, but output would still not change in response to an increase in G_t .

18.2.4 An Increase in the Money Supply: Increase in M_t

Now, consider an exogenous increase in M_t . M_t does not appear anywhere in the “real block” of the model (the first six equations). Hence, neither the IS nor the Y^s curves shift. There is no effect of the change in M_t on any real variable. We therefore say that “money is neutral,” by which we mean that a change in the money supply has no effect on any real variables.

The only effect of an increase in M_t will be on the price level. We can see this in a money market graph, shown below in Figure 18.9. The vertical money supply curve shifts to the right. The money demand curve does not shift. The only effect is an increase in P_t . The nominal interest rate is unchanged, since π_{t+1}^e is taken as given and r_t is unaffected.

Figure 18.9: Increase in M_t

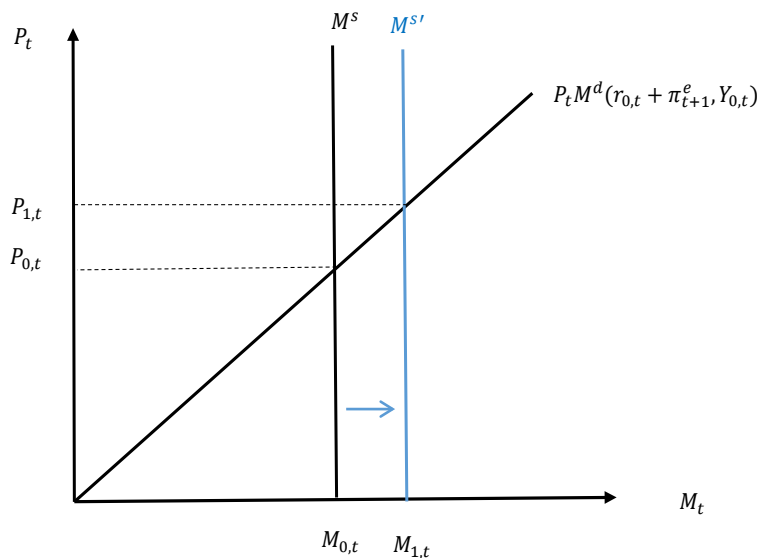

In this model, money is completely neutral – changes in M_t have no effect on any real variables. Though monetary neutrality is not how most people think about the real world (i.e. most people seem to think that what the Fed does matters for the real economy), the intuition for monetary neutrality is pretty clear once one thinks about it. Changing the quantity of M_t , in a sense, just changes the measurement of the units of account. Whether I call one can of soda 2 dollars or 4 dollars shouldn't impact how much soda I buy – when I purchase something like soda, I am functionally trading my time (which generates income in the form of the wages) for a good. Money is just an intermediary used in exchange, and how I value money shouldn't impact how much exchange I conduct. To get monetary non-neutrality, we need some form of “stickiness” in prices (how much I pay for the soda) or wages (how

much income I earn from my time spent working, which influences how much soda I can purchase). If prices and/or wages are unable to instantaneously adjust to the change in M_t , changes in M_t could impact real variables like how much soda I consume. When we study Keynesian models later in Part V, we will do just this.

18.2.5 Expected Future Inflation: Increase in π_{t+1}^e

Finally, suppose that there is an exogenous increase in expected inflation, π_{t+1}^e . Like a change in M_t , this has no effect on any of the real variables in the model – neither the IS nor the Y^s curves shift, and there is no change in r_t or Y_t . For a fixed real interest rate, an increase in π_{t+1}^e raises the nominal interest rate, i_t , from the Fisher relationship. This higher nominal interest rate depresses the demand for money, causing the money demand curve to pivot in. Along a stable money supply curve, this results in an increase in P_t . This is shown below in Figure 18.10.

Figure 18.10: Increase in π_{t+1}^e

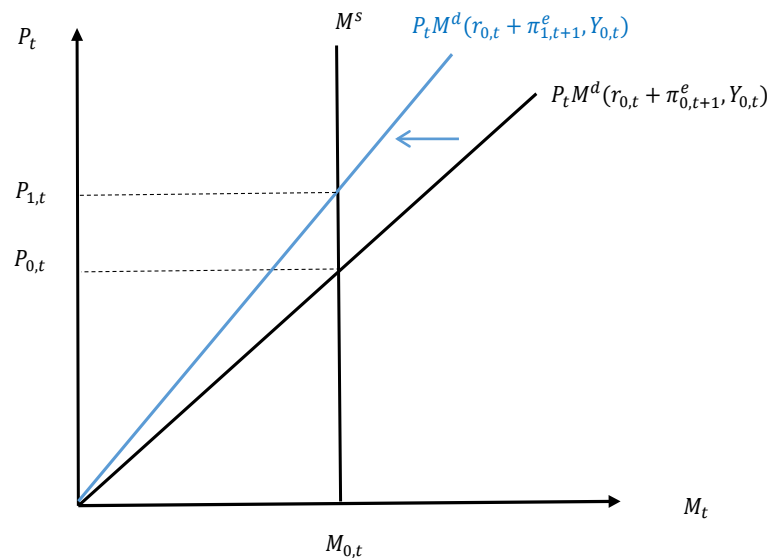

From Figure 18.10, we see that there is an element of “self-fulfillment” in terms of an increase in expected future inflation. Put differently, expecting more future inflation results in more current inflation (i.e. an increase in P_t). An increase in expected future inflation could be triggered by the central bank promising to expand the money supply in the future. From our analysis, this would have the effect of raising the price level in the present. This is, in a nutshell, what much of the non-standard monetary policy of the last several years has sought to accomplish.

18.2.6 Summary of Qualitative Effects

Table 25.1 summarizes the qualitative effects of increases in the different exogenous variables on the eight endogenous variables of the model. A + sign indicates that the endogenous variable in question increases when the relevant exogenous variable increases, a – sign indicates that the endogenous variable decreases, a ? indicates that the effect is ambiguous, and a 0 indicates that the endogenous variable is unaffected. Note that the effects of changes in θ_t and G_{t+1} are left as exercises.

Table 18.1: Qualitative Effects of Exogenous Shocks on Endogenous Variables

Variable	Exogenous Shock				
	$\uparrow A_t$	$\uparrow A_{t+1}$	$\uparrow G_t$	$\uparrow M_t$	$\uparrow \pi_{t+1}^e$
Y_t	+	0	0	0	0
C_t	+	?	-	0	0
I_t	+	?	-	0	0
N_t	+	0	0	0	0
w_t	+	0	0	0	0
r_t	-	+	+	0	0
i_t	-	+	+	0	+
P_t	-	+	+	+	+

18.3 Summary

- We can use the IS and Y^s curves to graphically analyze how the different endogenous variables of the neoclassical model react to changes in the exogenous variables. In doing so, we treat the future capital stock as effectively fixed, which means that Y_{t+1} does not react to changes in period t exogenous variables which potentially impact period t investment.
- The neoclassical model offers a supply-driven theory of economic fluctuations. Because the Y^s curve is vertical, only supply shocks (changes in A_t or θ_t) can result in movements in output and labor market variables. Demand shocks (changes in A_{t+1} , G_t , or G_{t+1}) only affect the composition of output between consumption and investment, not the level of output.

- The real interest rate is a key price in the model which adjusts to shocks to force aggregate expenditure to equal aggregate production. Different assumptions on labor supply (see the relevant discussion in Chapter 12 or Appendix C) could generate an upward-sloping Y^s curve, but plausible parameterizations would generate a nearly vertical Y^s curve, wherein supply shocks would account for the vast majority of output and labor market fluctuations.
- The model features monetary neutrality and the classical dichotomy holds. Monetary neutrality means that changes in exogenous nominal variables do not affect the equilibrium values of real variables. The classical dichotomy means that real variables are determined in equilibrium independently of nominal variables – one need not know the values of the exogenous nominal variables to determine the equilibrium values of the endogenous real variables.
- The converse is not true – changes in real exogenous variables will affect nominal endogenous variables. Positive supply shocks (increase in A_t or a decrease in θ_t) result in a lower price level; positive demand shocks (increases in A_{t+1} and G_t , or a decrease in f_t or in G_{t+1}) raise the price level.

Key Terms

- Classical dichotomy
- Monetary neutrality
- Fixed interest rate government spending multiplier
- Crowding out

Questions for Review

1. Can you provide any intuition for the neutrality of money in the neoclassical model? Do you think monetary neutrality is a good benchmark when thinking about the real world?
2. Define what is meant by the “classical dichotomy.” If the classical dichotomy holds, can we ignore nominal variables when thinking about the real effects of changes in real exogenous variables?
3. Explain why shocks to the IS curve have no effect on output in the neoclassical model.

Exercises

1. Consider the basic neoclassical model. Suppose that there is an increase in A_t . Draw out two versions of the model, one in which labor supply is relative elastic (i.e. sensitive to the real wage), and one in which labor supply is relatively inelastic (i.e. relatively insensitive to the real wage). Comment on how the magnitudes of the changes in Y_t , r_t , w_t , and N_t depend on how sensitive labor supply is to the real wage.
2. Consider the basic Neoclassical model. Suppose that there is an increase in θ_t .
 - (a) Graphically analyze this change and describe how each endogenous variable changes.
 - (b) Now, draw out two versions of the model, one in which labor demand is relatively elastic (i.e. sensitive to the real wage), and one in which labor supply is relatively inelastic (i.e. relatively insensitive to the real wage). Comment on how the magnitudes of the changes in Y_t , r_t , w_t , and N_t depend on how sensitive labor supply is to the real wage.
3. Consider the basic neoclassical model. Suppose that there is an increase in θ_t . Draw out two versions of the model, one in which labor demand is relatively elastic (i.e. sensitive to the real wage), and one in which labor supply is relatively inelastic (i.e. relatively insensitive to the real wage). Comment on how the magnitudes of the changes in Y_t , r_t , w_t , and N_t depend on how sensitive labor supply is to the real wage.
4. Consider the basic neoclassical model. Suppose that there is a reduction in A_t . In which direction will P_t move? Will it change more or less if money demand is less sensitive to Y_t ?
5. Consider the basic Neoclassical model. Graphically analyze the effects of:
 - (a) An increase in G_{t+1} .
 - (b) An increase in A_{t+1} .
 - (c) A permanent increase in productivity (i.e. A_t and A_{t+1} increase by the same amount). In each case. In each case, clearly describe how each endogenous variable changes.
6. Consider two different versions of the basic neoclassical model. In one, the marginal propensity to consume (MPC) is relatively large, in the other the MPC is relatively small.

- (a) Show how a higher or lower value of the MPC affects the slope of the IS curve.
- (b) Suppose that there is an increase in f_t . Show graphically how this impacts equilibrium r_t in the two cases considered in this problem – one in which the MPC is relatively large, and one in which the MPC is relatively small.
7. **[Excel Problem]** Suppose that we have a neoclassical model. This problem will give specific functional forms for the equations underlying the model. Begin with the supply side. Suppose that labor demand supply are given by:

$$N_t = a_1 w_t - a_2 \theta_t \quad (18.21)$$

$$N_t = -b_1 w_t + b_2 A_t + b_3 K_t \quad (18.22)$$

(18.21) is the labor supply curve and (18.22) is labor demand. a_1 , a_2 , and $b_1 - b_3$ are positive parameters.

- (a) Use (18.21)-(18.22) to solve for expressions for N_t and w_t as a function of parameters and exogenous variables.
- (b) Suppose that $a_1 = 1$, $a_2 = 0.4$, $b_1 = 2$, $b_2 = 0.5$, and $b_3 = 0.3$. Suppose further that $\theta_t = 3$, $A_t = 1$, and $K_t = 20$. Create an Excel file to solve for numerical values of N_t and w_t using your answer from the previous part.
- (c) Suppose that the production function is $Y_t = A_t K_t^\alpha N_t^{1-\alpha}$. Suppose that $\alpha = 1/3$. Use your answer from the previous parts, along with the given values of exogenous variables and parameters, to solve for Y_t .

Now let us turn to the demand side. Suppose that the consumption and investment demand functions are:

$$C_t = c_1(Y_t - G_t) + c_2(Y_{t+1} - G_{t+1}) - c_3 r_t \quad (18.23)$$

$$I_t = -d_1 r_t + d_2 A_{t+1} + d_3 K_t \quad (18.24)$$

The aggregate resource constraint is $Y_t = C_t + I_t + G_t$.

- (d) Use the aggregate resource constraint, plus (18.23)-(18.24), to derive an expression for r_t as a function of Y_t and other variables (for the purposes of this exercises, treat Y_{t+1} as exogenous). In other words, derive an expression for the IS curve.

- (e) Suppose that $c_1 = 0.5$, $c_2 = 0.4$, $c_3 = 1$, $d_1 = 20$, $d_2 = 0.5$, and $d_3 = 0.1$. Suppose further that $A_{t+1} = 1$, $Y_{t+1} = 1.2$, $G_t = 0.2$, and $G_{t+1} = 0.2$. Given your answer for the value of Y_t above, your expression for the IS curve, and these parameter values to solve for numeric values of r_t , C_t , and I_t .
- (f) Suppose that A_t increases from 1 to 1.2. Solve for new numeric values of Y_t , N_t , w_t , r_t , C_t , and I_t . Do these move in the same direction predicted by our graphical analysis?
- (g) Set A_t back to 1. Now suppose that G_t increases from 0.2 to 0.3. Solve for numerical values of the endogenous variables in your Excel file. Do these variables change in the way predicted by our graphical analysis?

Chapter 19

Taking the Neoclassical Model to the Data

In Chapter 18, we analyzed how changes in different exogenous variables would impact the endogenous variables of the neoclassical model. This Chapter, we seek to investigate whether or not the basic neoclassical model can produce movements in endogenous variables that look like what we observe in the data. To the extent to which the model can do this, which exogenous driving force must be the main driver of the business cycle? Is there any model-free evidence to support this mechanism? These are the questions we take up in this Chapter.

19.1 Measuring the Business Cycle

When economists talk about the “business cycle” they are referring to fluctuations in real GDP (or other aggregate quantities) about some measure of trend. As documented in Part II, the defining characteristic of real GDP is that it trends up. When moving away from the long run, we want to focus on movements in real GDP and other aggregate variables about the long run trend. As such, it is necessary to first remove a trend from the observed data.

Formally, suppose that a series can be decomposed into a “trend” component, which we demarcate with a superscript τ , and a cyclical component, which we denote with a superscript c . Suppose that the series in question is log real GDP. The decomposition of real GDP into its trend and cyclical component is given by (19.1) below:

$$\ln Y_t = \ln Y_t^\tau + \ln Y_t^c \quad (19.1)$$

Given a time series, $\ln Y_t$, our objective is to first come up with a time series of the trend component, $\ln Y_t^\tau$. Once we have this, the cyclical component is simply defined as the residual, i.e. $\ln Y_t^c = \ln Y_t - \ln Y_t^\tau$. In principle, there are many ways in which one might remove a trend from a trending time series. The most obvious way to do this is to fit a straight line through the series. The resulting straight line would be the “trend” component while the deviations of the actual series from trend would be the cyclical component. Another way to come up with a measure of the trend component would be to take a moving average. In

particular, one could define the trend component at a particular point in time as the average realization of the actual series in a “window” around that point in time. For example, if the data are quarterly, a two-sided one year moving average measure of the trend would be $\ln Y_t^\tau = \text{average}(Y_{t-4}, Y_{t-3}, Y_{t-2}, Y_{t-1}, Y_t, Y_{t+1}, Y_{t+2}, Y_{t+3}, Y_{t+4})$.

As is common in academic work, we will measure the trend using the Hodrick-Prescott (HP) Filter. The HP filter picks out the trend component to minimize the volatility of the cyclical component, subject to a penalty for the trend component itself moving around too much. The HP filter is very similar to a two-sided moving average filter. In Figure 19.1 below, we plot the time series of the cyclical component of real GDP after removing the HP trend from the series. The shaded gray regions are recessions as defined by the National Bureau of Economic Research (NBER). For more on recession dates, see [here](#). The cyclical component of output rises and falls. It tends to fall and be low during periods identified by the NBER as recessions.

Figure 19.1: Cyclical Component of Real GDP

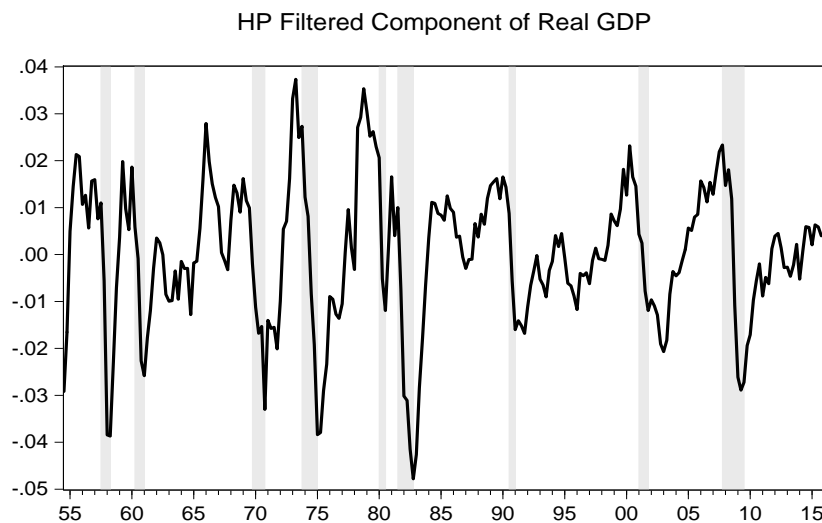

In modern macroeconomic research, one typically studies the “business cycle” by looking at second moments (i.e. standard deviations and correlations) of aggregate time series. Second moments of all series are frequently compared to output. One typically looks at standard deviations of different series relative to output as measures of relative volatilities of series. For example, in the data, investment is significantly more volatile than output, which is in turn more volatile than consumption. Correlations between different series and output are taken to be measures of cyclicity. If a series is positively correlated with output, we say that series is procyclical. This means that when output is above trend, that series tends to also be above its trend (and vice-versa). If the series is negatively correlated with output, we

say it is countercyclical. If it is roughly uncorrelated with output, we say that it is acyclical.

Because the model with which we have been working is qualitative in nature, it is not possible to focus on relative volatilities of series. Instead, we will focus on cyclicalities of different series, by which we simply mean the correlation coefficient between the cyclical component of a series with the cyclical component of output. The first inner column of Table 19.1 below shows correlations between the cyclical components of different aggregate times series with output. The six variables on which we focus are aggregate consumption, investment, labor input, the real wage, the real interest rate, and the price level. These correspond to the key endogenous variables (other than output) in our model. Consumption corresponds to total consumption expenditures and investment to gross private fixed investment. These series, along with the real GDP series, are available from the BEA. The total labor input series is total hours worked in the non-farm business sector, available [here](#). The real wage series is real compensation in the non-farm business sector, available [here](#). The real interest rate is constructed using the Fisher relationship. We use the Federal Funds Rate as the nominal interest rate, and use next-period realized inflation as the measure of expected inflation to compute the real interest rate. The price level is the GDP price deflator, also available from the BEA.

Table 19.1: Correlations Among Variables in the Data and in the Model

Variable	Corr w/ Y_t in Data	Corr conditional on A_t	Corr conditional on θ_t
C_t	0.88	+	+
I_t	0.91	+	+
N_t	0.87	+	+
w_t	0.20	+	-
r_t	0.10	-	-
P_t	-0.46	-	-

We see that consumption, investment, and labor hours are strongly positively correlated with output – these correlations are all above 0.85. This means that when output is high (low) relative to trend, these other series are on average also high (low) relative to trend. The real wage is procyclical, with a positive correlation with GDP of 0.20. This correlation is substantially lower than the cyclicalities of consumption, investment, and hours. The real interest rate is essentially acyclical – its correlation with output is about 0.10. Depending on how the real interest rate is measured (i.e. which nominal interest rate to use, or how to measure expected inflation), this correlation could be closer to zero or mildly negative. Regardless of construction, the real interest rate is never strongly cyclical in one direction or another. The price level is countercyclical.

There are good reasons to think that the observed cyclicalities of the real wage understates the true cyclicalities of real wages in the real world. This is due to what is known as the “composition bias.” The aggregate wage series used to measure the aggregate real wage is essentially a measure of the average wage paid to workers. If the real world featured one type of worker (like our simple model does), this wouldn’t be a problem. But in the real world workers are paid substantially different wages. It is an empirical fact that employment fluctuations over the business cycle tend to be relatively concentrated among lower wage workers. If job loss during a recession tends to be concentrated among lower wage workers, even if every worker’s individual wage is unchanged the average wage will tend to rise due to the composition of the workforce shifting from low to high wage workers. This will tend to make the real wage look high when output is low (i.e. countercyclical). The reverse would be true in an expansion. [Solon, Barsky, and Parker \(1994\)](#) study the importance of this so-called composition bias for the cyclicalities of the aggregate real wage and find that is quantitatively important. In particular, the correlation of a composition-corrected real wage series with aggregate output is likely substantially larger than the 0.20 shown in the table above.

19.2 Can the Neoclassical Model Match Business Cycle Facts?

Having now established some basic facts concerning business cycle correlations in the data, we now want to take our analysis a step further. We ask the following question: can the basic neoclassical model qualitatively match the correlations documented in [Table 19.1](#)? If so, which exogenous variable could be responsible for these co-movements?

Since the neoclassical model features a vertical Y^s curve, the only exogenous variables which can generate a business cycle (i.e. changes in output) are A_t (productivity) and θ_t (labor supply). Changes in variables which impact the IS curve (G_t , G_{t+1} , and A_{t+1}) only affect the composition of output, not output itself, and are therefore not candidates to explain fluctuations in output within the context of the neoclassical model. When we move to the short run in [Part V](#), we will extend our analysis into a framework in which changes in these variables can impact output, but in the neoclassical model they cannot.

The second and third inner columns of [Table 19.1](#) present the qualitative correlations among different variables with output in the neoclassical model conditional on changes in A_t and θ_t . A + sign indicates that the variable in the relevant row co-moves positively with output (i.e. increases when output increases, and decreases when output decreases). A – sign indicates that the variable in question co-moves negatively with output.

An increase (decrease) in A_t causes Y_t to increase (decrease), along with increases (decreases) in C_t , I_t , N_t and w_t . This means that, conditional on a change in A_t , these variables

co-move positively with output, hence the + signs in the relevant parts of the table. In the model, an increase (decrease) in A_t causes r_t to decline (increase) and P_t to decline (increase), so these variables co-move negatively with output, hence the – signs. Focus next on the co-movements implied by changes in θ_t . An increase (decrease) in θ_t causes output to decline (increase). Along with output, consumption, investment, and labor input all decrease (increase), hence these series co-move positively with output. Differently than conditional on changes in A_t , changes in θ_t cause the real wage to co-move negatively with output, hence the – sign in the table. The real interest rate increases when θ_t increases, and so co-moves negatively with output. So too does the price level.

Compared to the data, changes in A_t or θ_t can generate (at least qualitatively) the correct co-movements with output for consumption, investment, hours, and the price level. For both A_t and θ_t , the implied correlation between the real interest rate and output is off relative to the data. Changes in A_t generate positive co-movement between the real wage and output, consistent with what is observed in the data. Differently than the data, changes in θ_t generate negative co-movement between the real wage and output. To the extent to which the so-called composition bias is important, the implied countercyclicality of the real wage conditional on shocks to θ_t is problematic. We can conclude that the neoclassical model can best match observed business cycle correlations when it is primarily driven by changes in A_t .¹

There is still a problem in the sense that the model implies that increases (decreases) in A_t ought to trigger a decrease (increase) in the real interest rate, implying negative co-movement between the interest rate and output, whereas in the data the real interest rate is approximately acyclical. This is fairly easy to reconcile within the context of the model. In our previous analysis, we have focused on a change in A_t , holding A_{t+1} fixed. In reality, changes in productivity are likely to be quite persistent in the sense that an increase in A_t likely means that A_{t+1} will increase as well. In Figure 19.2, we consider the effects of a simultaneous increase in A_t and A_{t+1} in the neoclassical model. The increase in A_t shifts the Y^s curve out, which on its own would result in an increase in Y_t and a reduction in r_t . The increase in A_{t+1} shifts the IS curve out, which on its own would have no impact on Y_t but would result in r_t increasing. In other words, A_t and A_{t+1} have competing effects on r_t . Depending on how much A_{t+1} increases relative to A_t , as well as how sensitive investment is to A_{t+1} , the real interest rate could on net fall (as it does when just A_t increases), rise (as it does when just A_{t+1} increases), or do nothing at all (as we have shown here). Note that in a hypothetical situation in which both A_t and A_{t+1} increase, leaving the real interest rate

¹Note that this is not meant to suggest that changes in A_t are the *only* source of business cycle fluctuations in the model. A_t and θ_t (along with exogenous variables which affect the position of the IS curve) could all be changing simultaneously. We simply mean that A_t must be the *predominant* source of exogenous changes for the model to best fit the data, at least on the dimensions which we are studying.

unaffected, the changes in Y_t , N_t and w_t would be identical to the case where just A_t changes in isolation. Even with no decline in r_t , both C_t and I_t would increase – C_t because of the higher Y_t and anticipation of higher Y_{t+1} due to the anticipated increase in A_{t+1} , and I_t due to the anticipation of higher A_{t+1} . In other words, with a persistent change in productivity, the neoclassical model can qualitatively generate the co-movements we observe in the data – output, consumption, investment, labor hours, and the real wage all moving together, with the real interest rate roughly unchanged and the price level moving opposite output.

Figure 19.2: Increase in A_t and A_{t+1}

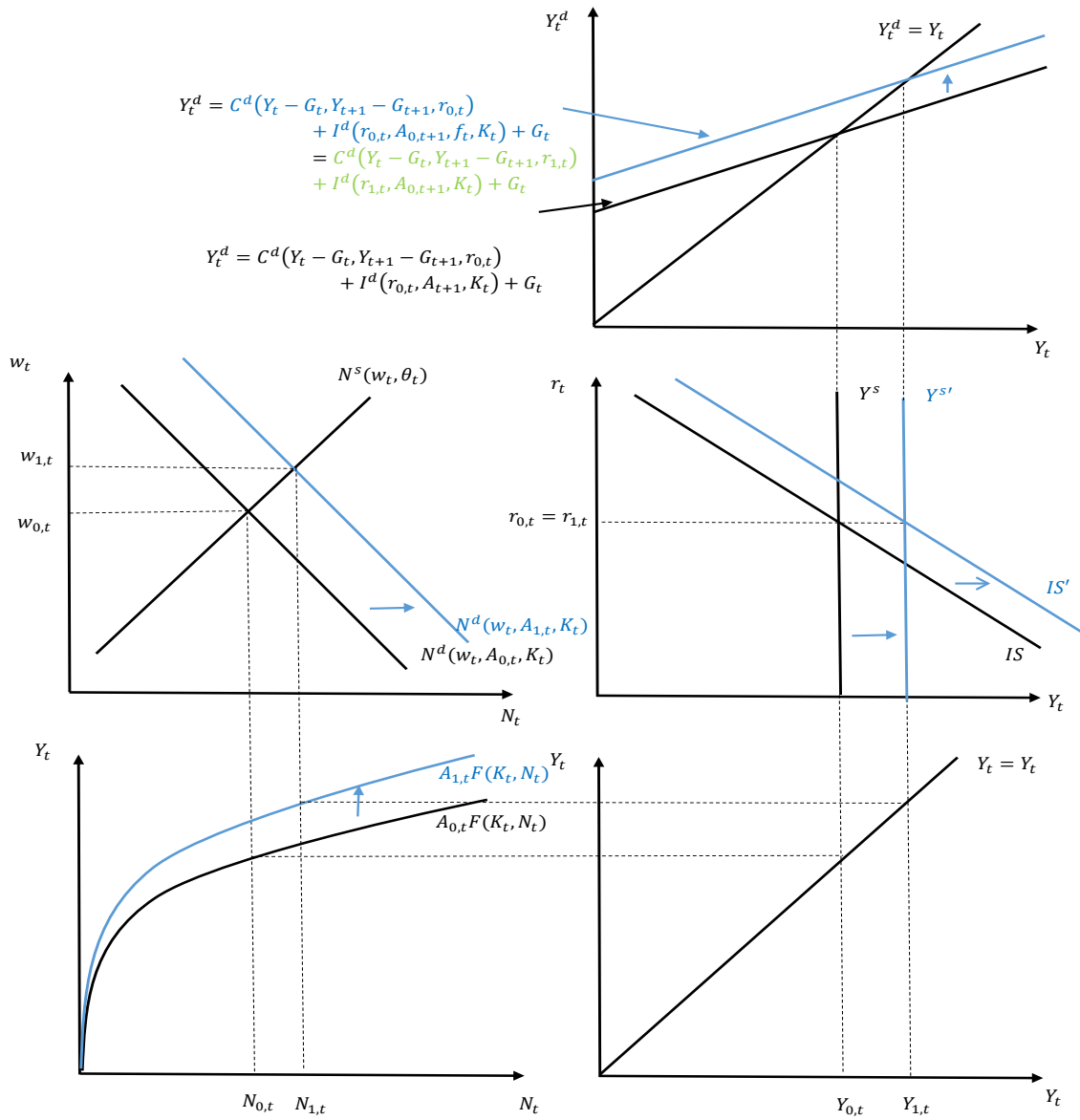

19.3 Is there Evidence that A_t Moves Around in the Data?

We have established that the neoclassical model can generate movements in output and other endogenous variables which qualitatively resemble what we observe in the data when the model is predominantly driven by shocks to productivity – i.e. exogenous changes in

A_t . Is there any evidence that A_t in fact moves around much in the data, and to the extent to which it does, are those movements consistent with what the model would imply output should be doing?

One can come up with an empirical measure of A_t without reference to all of the model if one is willing to make an assumption about the aggregate production function. As in the Solow model, assume that the production function is Cobb-Douglas:

$$Y_t = A_t K_t^\alpha N_t^{1-\alpha} \quad (19.2)$$

Take natural logs of (19.2) and re-arrange:

$$\ln A_t = \ln Y_t - \alpha \ln K_t - (1 - \alpha) \ln N_t \quad (19.3)$$

If one observes time series on Y_t , K_t , and N_t (which, in principle, are available from the national economic accounts), and if one is willing to take a stand on a value of α , one can back out a measure of $\ln A_t$ as the part of output that cannot be explained given observable capital and labor inputs. If factor markets are competitive, $1 - \alpha$ should correspond to labor's total share of income. In other words, if the real wage equals the marginal product of labor, then for the Cobb-Douglas production function we ought to have:

$$w_t = (1 - \alpha) A_t K_t^\alpha N_t^{-\alpha} \quad (19.4)$$

(19.4) is nothing more than the condition $w_t = A_t F_N(K_t, N_t)$. One can multiply and divide the right hand side of (19.4) to get:

$$w_t = (1 - \alpha) \frac{Y_t}{N_t} \quad (19.5)$$

Re-arranging terms in (19.5), one gets:

$$1 - \alpha = \frac{w_t N_t}{Y_t} \quad (19.6)$$

(19.6) says that $1 - \alpha$ ought to equal total payments to labor ($w_t N_t$) divided by total income (Y_t). This is sometimes called “labor’s share” of income. In the data, labor’s share of income is approximately constant at around 2/3 from the end of World War 2 through about 2000. This implies a value of $\alpha = 1/3$. Since 2000, labor’s share has been steadily declining, and is about 0.6 at present. Although this recent decline in labor’s share is quite interesting, we will ignore it and treat α as a constant equal to 1/3. Given this, as well as measurements on Y_t , K_t , and N_t , we can use (19.3) to back out an empirical measure of A_t . This empirical measure of A_t is sometimes called “total factor productivity” (or TFP) since it is that part

of output which cannot be explained by the factors capital and labor. The empirical measure of A_t is sometimes also called a “Solow residual” after Bob Solow of Solow model fame.

Figure 19.3 plots the cyclical components of real GDP (black line) along with the cyclical component of TFP (blue line). The shaded gray bars are recessions as dated by the NBER. One observes from the figure that TFP and GDP seem to co-move strongly. TFP tends to rise and fall at the same time output rises or falls. TFP declines and is low relative to trend in all identified recessions. The correlation between the cyclical component of the TFP series and the cyclical component of output is very high, at 0.78. It is also the case that the cyclical component of TFP is quite persistent in the sense of being positively autocorrelated. This is consistent with productivity shocks being persistent (i.e. increases in A_t portend increases in A_{t+1} in a way consistent with the analysis immediately above).

Figure 19.3: Cyclical Components of Real GDP and TFP

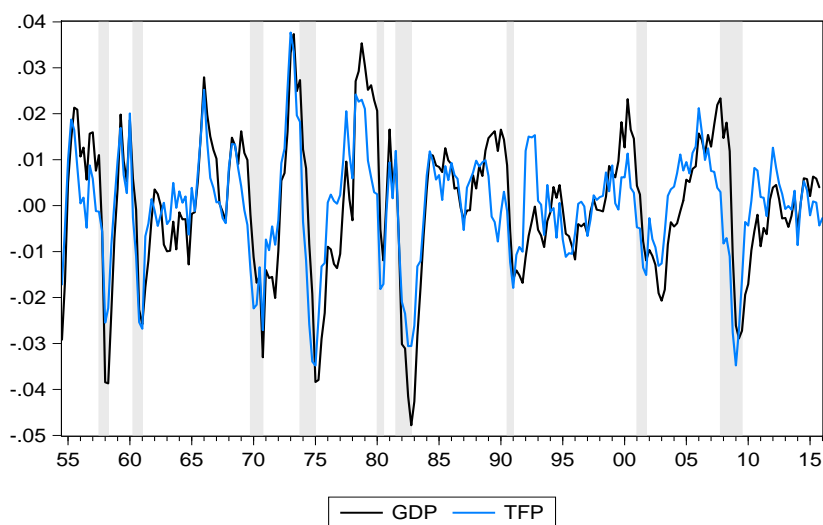

The visual evidence apparent in Figure 19.3 is often taken to be evidence in support of the neoclassical model. For the model to generate the qualitatively right co-movements among aggregate variables, it needs to be driven by persistent changes in productivity (by persistent we mean A_t and A_{t+1} increase or decrease together). We see this in the data – A_t moves around quite a bit, and is quite persistent in the sense of being highly autocorrelated. Furthermore, the increases and decrease in A_t we observe over time line up with the observed increases and decreases in output. In particular, recessions seem to be times when productivity is low, and expansions times when productivity is high. This seems to provide evidence in favor of the model.

We should mention at this point that there are potentially important measurement issues with regard to TFP, some of which cast doubt on this apparent empirical support for the

neoclassical model. Will return to criticisms of TFP measurement in Chapter 21.

19.4 Summary

- All data series consist of a trend component and a cyclical component. The cyclical component is how the series moves over the business cycle. The cyclical component is not invariant to how the trend component is computed. Most macroeconomists use an HP filter.
- A series is procyclical if it is positively correlated with output. A series is countercyclical if it is negatively correlated with output. A series is acyclical if it is uncorrelated with output. In the data, consumption, investment, real wages, and hours are procyclical. The price is countercyclical and the real interest rate is approximately acyclical.
- No exogenous variable in isolation can induce the same correlations in the Neoclassical model as we see in the data. However, the Neoclassical model is consistent with all these comovements if business cycles are driven by persistent changes in productivity.
- We can construct an empirical measure of productivity by subtracting output from its share-weighted inputs. As in the Solow model, we call this difference "Total Factor Productivity." TFP is strongly procyclical and persistent. To the extent empirical TFP is a good measure of productivity, the Neoclassical model performs quite well in matching the data.

Key Terms

- Linear trend
- Moving average
- HP filter
- Cyclical
- Composition bias
- Total Factor Productivity

Questions for Review

1. Rank the following series from most to least volatile: output, consumption, investment.

2. Describe the cyclical nature of consumption, investment, hours, the real wage, and real interest rate.
3. Why might the true correlation of real wages with output be understated in the data?
4. Is there one exogenous variable in the Neoclassical model that can explain all the correlations in the data? If so, which one? If not, can any two shocks simultaneously explain the correlations?
5. How is the productivity series constructed in the data? Does it move positively or negatively with output?

Exercises

1. **[Excel Problem]** Go to the Federal Reserve Bank of St. Louis FRED website. Download data on [real GDP](#), [real personal consumption expenditures](#), [real gross private domestic investment](#), the [GDP price deflator](#), [total hours worked per capita in the non-farm business sector](#), and [real average hourly compensation in the non-farm business sector](#). All series should be at a quarterly frequency. Download these data from 1947q1 through the most recent available date. Take the natural log of each series.
 - (a) Isolate the cyclical component of each series by first constructing a moving average trend measure of each series. In particular, define the trend component of a series as the two year, two-sided moving average of a series. This means that you will lose two years (eight quarters) worth of observations at the beginning and end of the sample. Concretely, your measure of trend real GDP in 1949q1 will be the average value of actual real GDP from 1947q1 (eight observations prior to 1949q1) through 1951q1 (eight observations subsequent to 1949q1). Compute this for every observation and for each series. Then define the cyclical component of a series as the actual value of the series minus its trend value. Produce a time series plot of the cyclical component of real GDP. Do observed declines in real GDP align well with the NBER dates of recessions (which can be found [here](#))?
 - (b) Compute the standard deviations of the cyclical component of each series. Rank the series in terms of their volatilities.
 - (c) Compute the correlations of the cyclical component of each series with the cyclical component of output. Do the signs of the correlations

roughly match up with what is presented in Table 19.1?

- (d) If the production function is Cobb-Douglas, then the real wage (which equals the marginal product of labor) ought to be proportional to the average product of labor (since with a Cobb-Douglas production function the marginal product and average product of each factor are proportional to one another). In particular:

$$w_t = (1 - \alpha) \frac{Y_t}{N_t} \quad (19.7)$$

$\frac{Y_t}{N_t}$ is average labor productivity. Download data on this series from the St. Louis Fed, which is called [real output per hour of all persons](#). Compute the trend component of the log of this series like you did for the others, and then compute the cyclical component by subtracting the trend component from the actual series. Compute the correlation between this series and the empirical measure of w_t (real average hourly compensation in the non-farm business sector). The theory predicts that this correlation ought to be 1. Is it? Is it positive?

- (e) Take your series on the log wage and log labor productivity (the levels of the series, not the trend or cyclical components) and compute $\ln w_t - \ln\left(\frac{Y_t}{N_t}\right)$. If the theory is correct, this series ought to be proportional to $1 - \alpha$, which is labor's share of income (it won't correspond to an actual numeric value of $1 - \alpha$ since the units of the wage and productivity series are indexes). What does this plot look like? What can you conclude has been happening to $1 - \alpha$ over time?

Chapter 20

Money, Inflation, and Interest Rates

How is the quantity of money measured? What determines the average level of inflation in the medium run? What about expected inflation (which we have taken to be exogenous)? And what about the level of the nominal interest rate? Although money is neutral with respect to real variables in the neoclassical model, does this hold up in the data? In this Chapter, we use the building blocks of the neoclassical model to explore these questions.

20.1 Measuring the Quantity of Money

In Chapter 14, we defined money as an asset which serves the functions of a medium of exchange, a store of value, and a unit of account. Most modern economies operate under a fiat money system, wherein the thing used as money has no intrinsic value and only has value because a government (by fiat) issues that thing and agents accept it in exchange for goods and services. In the United State, the dollar is the unit of money. In Europe, it is the Euro, and in Japan the Yen.

How does one measure the quantity of money in an economy? This may seem like a silly question – wouldn't one just count up the number of dollars (or euro, or Yen)? It turns out that this is not such an easy question to answer. Most of the dollars out there do not exist in any tangible form. While there is currency (physical representations of dollars), much of the money supply is electronic and therefore does not exist in any tangible way. Because these electronic entries serve as a store of value, a unit of account, and a medium of exchange, they are money as well. Indeed, many different assets can be denominated in dollars and used in exchange, so measuring the money supply is not in fact so clear.

One can think about the quantity of money as the dollar value of assets which serve the three functions defined by money. Currency is one particular kind of asset. An “asset” is defined as “property owned by a person or community, regarded as having value available to meet debts, commitments, or legacies” (this definition comes from a Google search of the word “asset”). Currency (a physical representation of money – i.e. a dollar bill or a quarter) is an asset. Another kind of asset is a demand deposit, which refers to the funds people hold in checking accounts (it is called a “demand deposit” because people can demand the funds

in their account be paid out in currency at any time). Checks, which are simply claims on demand deposits, are used all the time to transfer resources from buyers and sellers (a debit card is simply a paperless form of a check). Other forms of assets could serve the functions of money. For example, money market mutual funds are financial instruments against which checks can often be written. Some savings accounts allow checks to be written against them, and in any event is relatively seamless to transfer money from a savings to a checking account.

Because there are many assets (all denominated in units of money) which can be used in transactions in addition to currency, there are many different ways to define the quantity of money. The most basic definition of the quantity of money is the currency in circulation. In 2016 in the United States, there were roughly 1.4 trillion dollars of currency in circulation. If you add in the total value of demand deposits (and other similar instruments) to the quantity of currency in circulation, the money supply would be about 3.2 trillion dollars. This means that there is close to 2 trillion more dollars in demand deposits than there is in currency. The next most basic definition of the money supply is called M1, and includes all currency in circulation plus demand deposits.

We can continue going further, including other assets into a definition of the quantity of money. M2 is defined as M1, plus money market mutual funds and savings deposits. Generally speaking, we can think about different assets according to their liquidity, by which we mean the ease with which these assets can be used in exchange. By construction, currency is completely liquid as it is “legal tender for all debts public and private.” Demand deposits are not quite currency, but because funds can be converted to currency on demand, they are nearly as liquid as currency and can be used directly for most types of transactions. Hence, relative to currency, M1 includes currency plus a slightly less liquid asset (demand deposits). M2 includes M1, plus some other assets that are not quite as liquid as demand deposits (money market mutual funds and savings accounts). M3 is another measure of the money supply. In addition to M2 (which in turn includes M1, which itself includes currency), M3 includes institution money market funds (money market funds not held by individual investors) and short term repurchase agreements. [Wikipedia](#) has a decent entry on definitions of the money supply and how they are employed around the world.

Figure 20.1 plots the time series of currency, M1, M2, and M3 for the United States over the period 1975-2005. The series are plotted in logs. One can visually see that M1 is substantially bigger than currency in circulation – for most periods, M1 is about 1 log point higher than currency, which means M1 is about 100 percent bigger than currency, or double, which is consistent with the numbers presented above. M2, in turn, is about 1 log point (or more) bigger than M1 in most periods, so M2 is about 100 percent bigger than M1, or about double the size of M1. M3, in contrast, is not much larger than M2. Most economists use M1

or M2 as their preferred measure of the quantity of money.¹ For most of this book, when referring to the quantity of money in the United States, we will be referring to M2.

Figure 20.1: Different Measures of the Money Supply

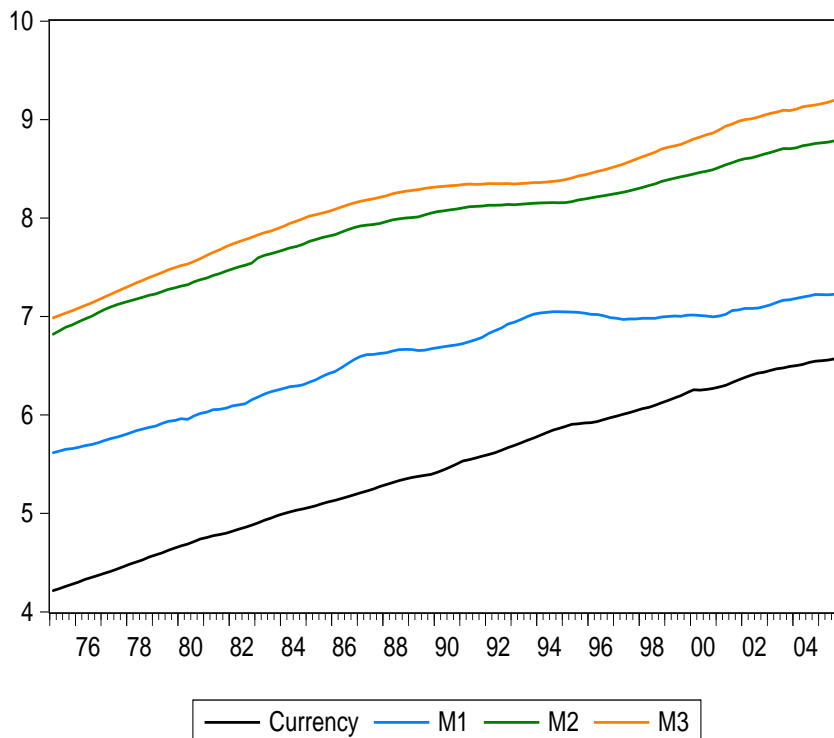

20.1.1 How is the Money Supply Set?

Who sets the money supply? How is it set? While these questions seem rather trivial, in reality they are pretty complicated. While the government is a monopoly supplier of currency, other assets which serve as money are privately created.

In your principles class you might have studied fractional reserve banking and the money creation process. We will not bore you with those details here, giving only a highly condensed version. If one is interested in more details, [Wikipedia](#) has a good entry on money creation. It is also discussed in more detail later in Chapter 31.

Modern economies have central banks, like the US Federal Reserve. In addition to regulating banks and serving as a “lender of last resort” in periods of high demand for liquidity (see the discussion in Chapter 32), the central bank can influence (though not completely control) the supply of money. The central bank can directly set the quantity of currency in circulation. Call this CU_t . The central bank can also set the quantity of reserves

¹Indeed, the Federal Reserve discontinued measuring M3 in 2006.

in the banking system. Reserves are balances held by banks which have not been lent out to others. These reserves are either kept as “vault cash” (i.e. currency sitting in the bank as opposed to in circulation), or on account with the central bank, where a bank’s reserve balance with the central bank is isomorphic to an individual’s checking account with a bank. In a 100 percent reserve banking system, bank loans must be backed by reserves of an equal amount. So if a bank has 500 dollars in deposits, it must hold 500 dollars in reserves – i.e. it has to keep the entire value of the deposits as vault cash or on account with the central bank.

Modern economies feature what are called “fractional reserve” banking systems. Banks make money by *not* holding reserves. The entire business of banking involves accepting deposits and lending the funds out for other uses (as is discussed in more detail in Chapter 30). For this reason, a bank would never choose to hold the value of its deposits in reserves. Rather, a bank would want to keep only a small amount of reserves on hand to be able to meet withdrawal demands, lending the rest out to households and businesses. Central banks often require banks to hold a certain amount of deposits in reserves. Economists refer to this amount as the require reserve ratio.

Reserves not required to be held by a central bank, or so-called “excess reserves,” can be lent out to households and firms. In lending these reserve out, a bank creates deposits. While banks *can* lend out excess reserves, in the process creating deposits, they are not *required* to do so. The central bank can influence the amount of deposits by adjusting reserves in the banking system. If the central bank takes actions which generate excess reserves (either by lowering the required reserve ratio or purchasing other assets, such as government debt, held by banks in exchange for reserves), then this can result in an expansion of deposits, and hence in the money supply.

These issues are discussed in much more detail in Chapter 31, but we provide a short and stylized description here. Denote the total quantity (both excess and reserved) reserve in the banking system as RE_t . Define the term MB_t , for monetary base, as the sum of currency in circulation plus reserves:

Define the monetary base, MB_t , as the sum of currency plus reserves:

$$MB_t = CU_t + RE_t \quad (20.1)$$

A central bank can directly set MB_t by either creating bank reserves through asset purchases or by printing more currency. But the money supply, as noted above, includes more than just currency – it also includes demand deposits, and potentially other forms of financial assets depending on which measure of money one prefers. While a central bank can directly set the monetary base, it can only indirectly set the money supply. This is because, as noted above, commercial banks can themselves create money by issuing loans, thereby

creating deposits. Influencing the quantity of reserves in the banking system will impact the quantity of loans made by banks, but only to the extent to which banks choose not to hold more reserves than required by law.

Figure 20.2 plots the time series of the natural logs of the monetary base (blue line) and the money supply (as measured by M2) for the United States. Visually, we can see that M2 is substantially higher than the monetary base. For the most part, the monetary base and the money supply move together. One does observe some anomalous behavior post-2008, when the monetary base increased substantially without much noticeable effect on the money supply. We will return more to this in Chapter 36.

Figure 20.2: M2 and the Monetary Base

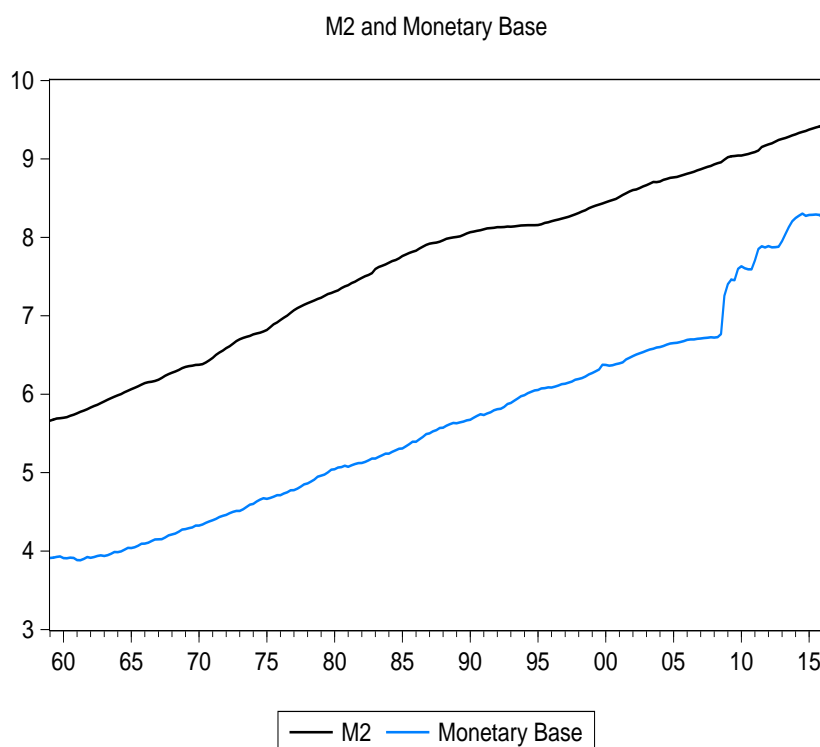

We can think about the money supply as equaling a multiple of the monetary base. In particular:

$$M_t = mm_t MB_t \quad (20.2)$$

Here, M_t is the money supply, and mm_t is what is called the money multiplier. In the simplest possible model in which banks hold no excess reserves and households hold no currency (see Chapter 31), the money multiplier is one divided by the required reserve ratio. So, if the central bank requires commercial banks to hold 20 percent of total deposits in the

form of reserves, the money multiplier would be 5 – the money supply would be five times larger than the monetary base. This expression for the money multiplier assumes that banks do not hold excess reserves and that individuals do not withdraw deposits for cash. Figure 20.3 plots the implied money multiplier for the US over time (using M2 as the measure of the quantity of money).

Figure 20.3: M2 Divided by the Monetary Base

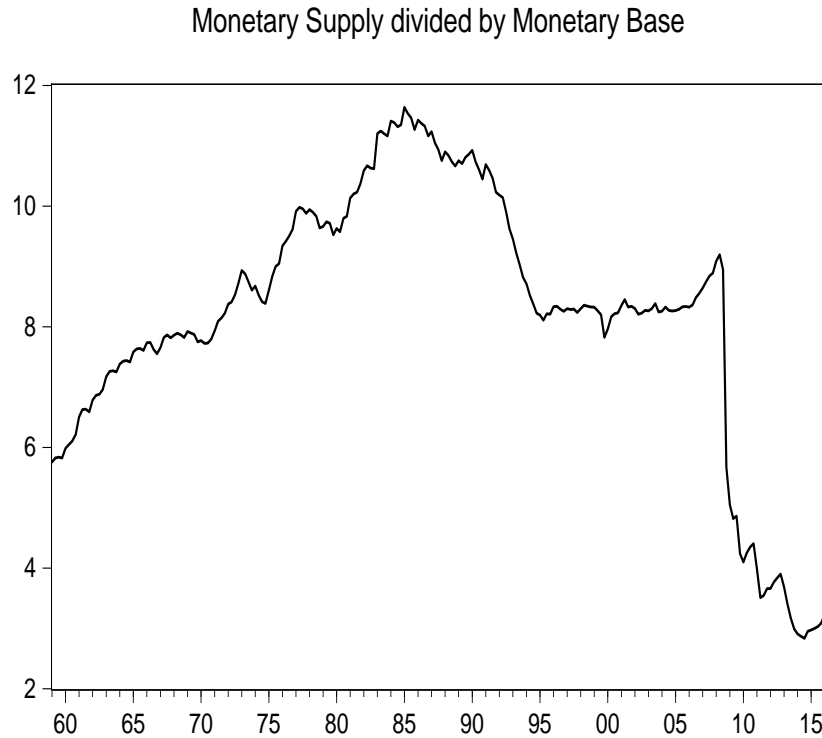

One can observe that the money multiplier is not constant. It consistently rose from 1960 through the 1980s. The implied money multiplier was very nearly constant from 1990 through the middle of the 2000s. The money multiplier then fell drastically post-2008 and has not recovered. The real world phenomenon driving this behavior is that commercial banks have been holding excess reserves – they have not been lending out the maximum amount of reserves.

As noted above, the central bank can directly control the monetary base, MB_t . It can only influence mm_t through its control of the required reserve ratio, but otherwise mm_t is out of the control of the central bank. It is therefore not particularly accurate to think of the central bank as having control over the supply of money. However, we will hereafter ignore this fact. We will therefore think of M_t as being an exogenous variable set by a central bank. But in reality, one must keep in mind that the central bank can really only directly control

the monetary base, MB_t , and hence indirectly the money supply, M_t . For more on the money creation process and the money multiplier, the interested reader is referred to Chapter 31.

20.2 Money, the Price Level, and Inflation

We are treating the supply of money, M_t , as being set exogenously by a central bank (subject to the caveats above). The demand for money is determined by actors in the economy. The price level, the inflation rate, the rate of expected inflation, and the nominal interest rate are in turn all determined by supply equaling demand in the market for money.

Recall our generic specification for the demand for money from the neoclassical model:

$$\frac{M_t}{P_t} = M^d(i_t, Y_t) \quad (20.3)$$

We have assumed that the demand for money is proportional to the price level, decreasing in the nominal interest rate (which can be written in terms of the real interest rate via $r_t = i_t - \pi_{t+1}^e$, where we have taken expected inflation to be exogenous), and increasing in total output, Y_t . Let's assume a particular functional form for this money demand specification, given by:

$$\frac{M_t}{P_t} = \psi_t i_t^{-b_1} Y_t \quad (20.4)$$

In (20.4), b_1 is assumed to be a constant parameter. Hence, we are assuming that the demand for real balances is decreasing in the nominal interest rate and proportional to total output. We have introduced a new term, ψ_t , which we take to be exogenous. We can think about ψ_t as measuring preferences for holding money – the bigger is ψ_t , the more money people would like to hold. We will return to this variable more below. In terms of a micro-founded money demand specification, we can think about ψ_t as being a parameter which scales the utility a household receives from holding money.

This money demand function can be written in terms of the real interest rate via:

$$\frac{M_t}{P_t} = \psi_t (r_t + \pi_{t+1}^e)^{-b_1} Y_t \quad (20.5)$$

In the neoclassical model, the classical dichotomy holds, and Y_t and r_t are determined independently of M_t or other nominal variables. We are treating (for now) the expected inflation rate as exogenous. This means that the right hand side of (20.5) is determined completely independently from the left hand side. As such, what this tells us is that changes in M_t will result in *proportional* changes in P_t . In other words, conditional on r_t , Y_t , and π_{t+1}^e , what determines the price *level* is the quantity of money, M_t .

What about the *rate of change* in the price level (i.e. the inflation rate)? Let's take natural logs of (20.4):

$$\ln M_t - \ln P_t = \ln \psi_t - b_1 \ln i_t + \ln Y_t \quad (20.6)$$

This equation must hold at every point in time. Subtract off the same expression dated in period $t - 1$ from (20.6) and re-arrange terms a bit to get:

$$\ln M_t - \ln M_{t-1} = \ln P_t - \ln P_{t-1} + \ln \psi_t - \ln \psi_{t-1} - b_1 (\ln i_t - \ln i_{t-1}) + (\ln Y_t - \ln Y_{t-1}) \quad (20.7)$$

Recall that the first difference across time of the natural log of a variable is approximately equal to the growth rate of that variable. If we are willing to assume that the nominal interest rate and the new exogenous variable ψ_t are roughly constant across time, we can write (20.7) as:

$$g_t^M = \pi_t + g_t^Y \quad (20.8)$$

In other words, (20.8) says that the growth rate of the money supply equals the sum of the inflation rate (the growth rate of the price level) and the growth rate of output. This expression can be re-arranged to yield:

$$\pi_t = g_t^M - g_t^Y \quad (20.9)$$

(20.9) says that the inflation rate equals the excess growth rate of the money supply over output (i.e. the difference between the growth rates of the money supply and output). So what determines the inflation rate? According to (20.9) and the assumptions going into it, inflation is caused by excessive money growth relative to output growth.

Over a sufficiently long period of time, output grows at an approximately constant rate (recall the stylized facts from Part II). Taken literally, then, (20.9) implies that money growth ought to translate one-for-one into the inflation rate. This would be consistent with the famous quote by Nobel prize winner Milton Friedman, who once said that “Inflation is everywhere and always a monetary phenomenon.” Does this implication hold up in the data? Figure 20.4 is a scatter plot of the (annualized) inflation rate (as measured by the GDP price deflator) and the (annualized) growth rate of the M2 money stock. Each circle represents a combination of inflation and money growth observed at a point in time. The straight line is a best-fitting regression line. One can observe that the two series move together, but the relationship is relatively weak. The correlation between the two series is 0.22 – positive, but

not overwhelmingly so.

Figure 20.4: Scatter Plot: Money Growth and Inflation

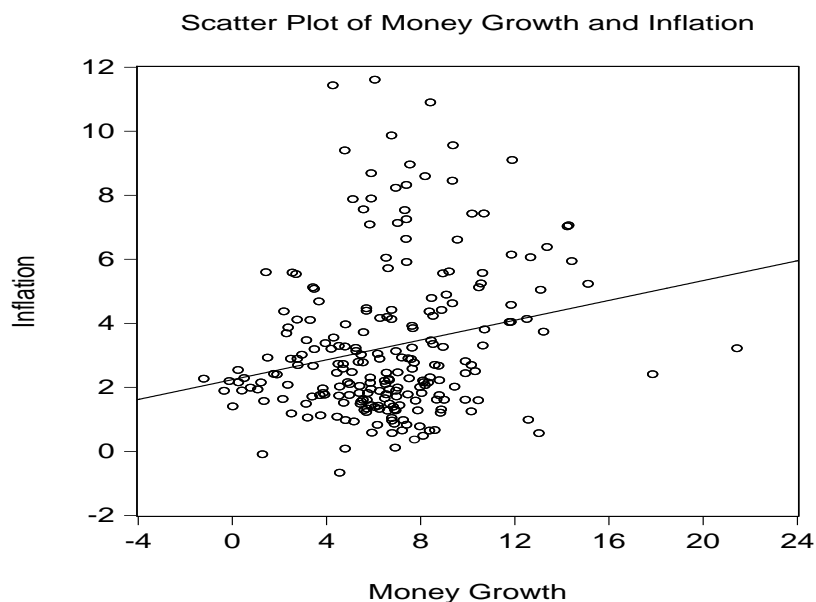
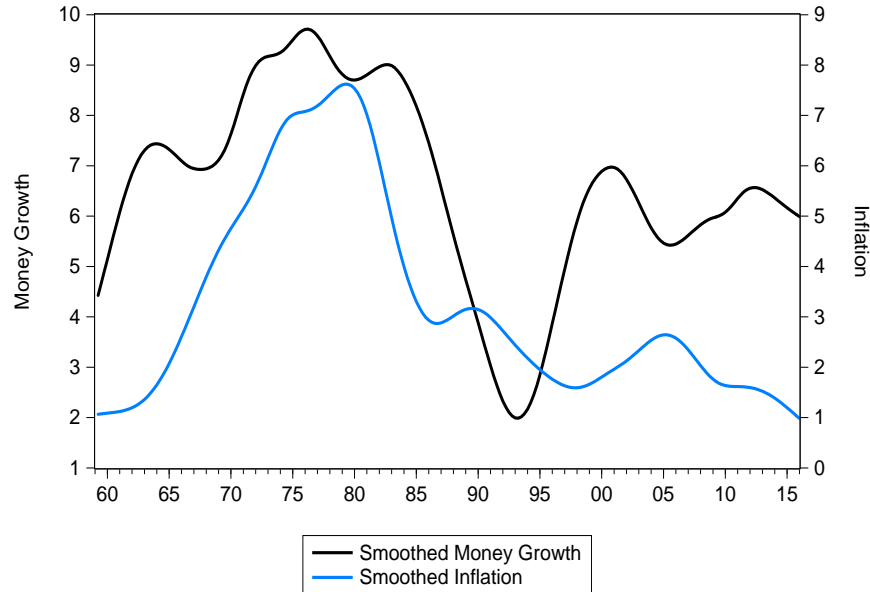

Figure 20.4 measures the inflation rate and the growth rate of the money via quarter-over-quarter changes in the M2 stock of money and the GDP price deflator (then expressed at annualized rates). Nominal interest rates are clearly not constant quarter-to-quarter, nor is there reason to think that ψ_t would necessarily be constant. Further, it could be that, in the short run, changes in the money supply impact real output (as we will see in Part V). For these reasons, looking at the correlation between money growth and the inflation rate at a quarterly frequency may be asking too much of the theory.

Figure 20.5 plots the time series of “smoothed” money growth and inflation against time. These series are smoothed to remove some higher frequency (i.e. quarter-to-quarter) variation. The smoothed series ought to instead pick up lower frequency variation (i.e. changes in the series over the course of several years). Our smoothing technique is to look at the HP filter trend component of each series. The HP filter trend is essentially a two-sided moving average. In other words, the trend (or smoothed) value at a point in time is the average value of observations in a window around that point. The details of this smoothing procedure are unimportant. We can observe in the figure that the smoothed components of money growth and inflation do seem to move together. In particular, the correlation between these series is 0.66, which is substantially higher than the correlation between quarter-over-quarter growth rates of the two series of 0.22 mentioned above.

Figure 20.5: Smoothed Money Growth and Inflation



While Figure 20.5 seems to indicate that money growth and inflation seem to move together over longer periods of time, there is an interesting difference in the Figure pre- and post-1990. In particular, from 1960-1990, the plots of smoothed money growth and inflation are very similar. Indeed, the correlation between the two series over this sample is 0.79, which is substantially higher than over the full sample (0.66). After 1990, the series do not seem to move together nearly as much. While the smoothed inflation rate fell throughout the 1990s, money growth actually picked up. Further, while money growth has been increasing since 2005, the smoothed inflation rate has been falling. If one computes the correlation between smoothed money growth and inflation since 1990, it actually comes out to be negative (-0.51). What gives?

Let's re-write equation (20.4) by defining a term $V_t^{-1} = \psi_t \iota_t^{-b_1}$. We will call this term V_t the “velocity” of money. The money demand specification can then be written:

$$\frac{M_t}{P_t} = V_t^{-1} Y_t \tag{20.10}$$

Re-arranging terms:

$$M_t V_t = P_t Y_t \tag{20.11}$$

Expression (20.11) is often times called the “quantity equation.” In words, it says that money times velocity equals the price level times real output (which is nominal GDP). There is a natural economic interpretation of the velocity term in (20.11). Since $P_t Y_t$ is nominal

GDP, if money must be used for all transactions, then $\frac{P_t Y_t}{M_t}$ equals the average number of times that each unit of money is used (i.e. what is called velocity). The quantity equation, (20.11), can be defined independently of any economic theory. Given observed values of nominal GDP and the stock of money, one can then use this equation to determine V_t . Figure 20.6 below plots velocity as implicitly defined by (20.11) for the US since 1960:

Figure 20.6: Velocity

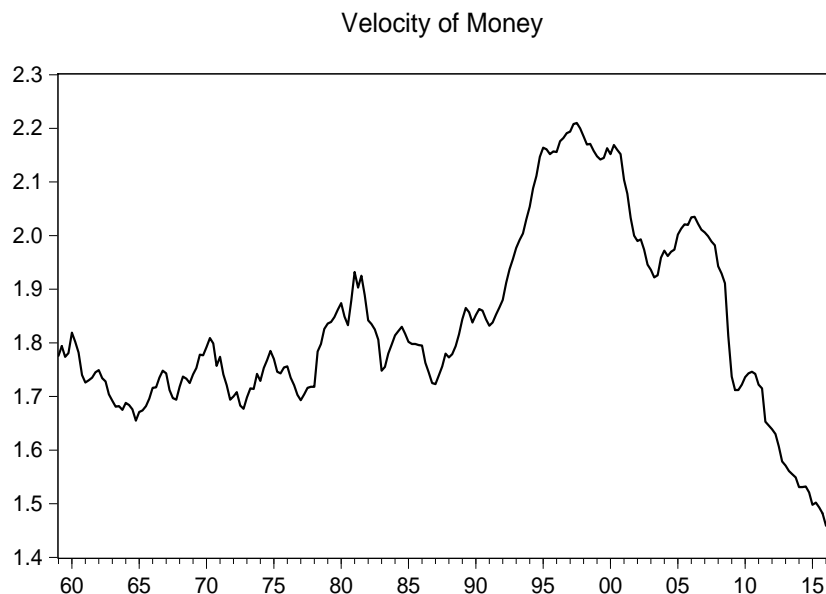

Figure 20.6 is quite interesting, particularly in light of Figure 20.5. From 1960-1990, we can see that velocity is approximately constant. Constant velocity in conjunction with the quantity equation is a central tenet of a school of thought called monetarism (see [here](#) for more). We can see from Figure 20.6 that the assumption of constant velocity clearly breaks down around 1990. Velocity increases during the first part of the 1990s and has been steadily declining ever since.

As noted above, (20.11) can be defined independently of any economic theory – one can use it to infer V_t from the data, given data on $P_t Y_t$ and M_t (which is what we do in Figure 20.6). But (20.11) can also be motivated from economic theory given a specification of money demand. In particular, using the money demand specification with which we have been working, V_t can be written:

$$V_t = \psi_t^{-1} i_t^{b_1} \tag{20.12}$$

From the perspective of our theory, the velocity of money could not be constant for two reasons – changes in ψ_t and changes in i_t . Increases in i_t increase the velocity of money, while

increases in ψ_t reduce it. Figure 20.7 below plots the time series of the (annualized) effective Federal Funds Rate over the period 1960-2016.

Figure 20.7: Nominal Federal Funds Rate

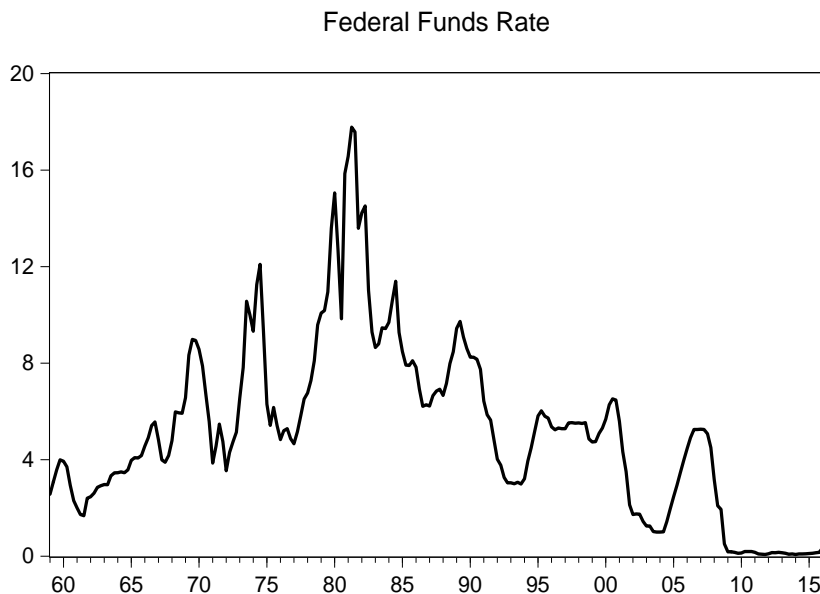

Visually, it appears as though the nominal interest rate and velocity are positively correlated, consistent with our theory. That said, it is difficult to square the near constancy of measured velocity from 1960-1990 with the highly volatile Federal Funds rate over that same period. Over the entire sample, the correlation between the Funds rate and velocity is 0.20, which is positively but not particularly strong. Since 1990, however, the correlation between the two series is much larger, at 0.74.

All this said, it is clear that changes in i_t alone cannot explain all of the observed behavior in velocity. From the perspective of our theory, the decline in velocity since 1990 must also be due to increases in ψ_t , which as noted above reflects a household's desire to hold money. In other words, since 1990, there has been an increasing demand for money, with this increasing demand for money particularly stark since the onset of the Great Recession (about 2008 or so). What real-world phenomena can explain this? Part of this is changes in transactions technology. Holding money used to be more costly in the sense that it was difficult to transfer cash into interest-bearing assets. Now this is much easier due to online banking, etc.. Part of the increase in the demand for money since the onset of the Great Recession is likely driven by uncertainty about the future and financial turmoil.

20.3 Inflation and Nominal Interest Rates

The previous section established that, to the extent to which velocity is constant (which is affected by nominal interest rates and the desire to hold money), in the medium run inflation is caused by excessive money growth over output growth. In this section, we explore the question of what determines the level of nominal interest rates in the medium run.

In our most basic model, the consumption Euler equation for an optimizing household can be written:

$$u'(C_t) = \beta u'(C_{t+1})(1 + r_t) \quad (20.13)$$

Let's assume a specific functional form for flow utility, the natural log. This means that (20.13) can be written:

$$\frac{C_{t+1}}{C_t} = \beta(1 + r_t) \quad (20.14)$$

If we take natural logs of this, we get:

$$\ln C_{t+1} - \ln C_t = \ln \beta + r_t \quad (20.15)$$

In (20.15), we have used the approximation that $\ln(1 + r_t) \approx r_t$. The log first difference of consumption across time is approximately the growth rate of consumption, which over sufficiently long periods of time is the same as the growth rate of output. Call this g_{t+1}^Y . Then we can expression r_t as:

$$r_t = g_{t+1}^Y - \ln \beta \quad (20.16)$$

Since $\beta < 1$, $\ln \beta < 0$, so if the economy has a positive growth rate $r_t > 0$. (20.16) tells us that, over sufficiently long time horizons, the real interest rate depends on the growth rate of output (it is higher the faster output grows) and how impatient households are (the smaller β is, the higher will be the real interest rate). The real interest rate in the medium run is independent of any nominal factors.

Recall that the Fisher relationship says that $r_t = i_t - \pi_{t+1}^e$. Plug this into (20.16) to get:

$$i_t = \pi_{t+1}^e + g_{t+1}^Y - \ln \beta \quad (20.17)$$

Although we have taken expected inflation, π_{t+1}^e , to be an exogenous variable, over long periods of time we might expect expected inflation to equal realized inflation (at least in an average sense). This just means that household expectations of inflation are correct on

average, not each period. If we replace expected inflation with realized inflation, (20.17) can be written:

$$i_t = \pi_t + g_{t+1}^Y - \ln \beta \quad (20.18)$$

To the extent to which output growth is fairly constant across time (which is one of the stylized growth facts), and that β is roughly constant over time, (20.18) implies that the level of the nominal interest rate ought to be determined by the inflation rate (which is in turn determined by money growth relative to output growth). In US data for the period 1960-2016, the correlation between the Federal Funds rate and the inflation rate (as measured by percentage changes in the GDP price deflator) is 0.70, which is consistent with (20.18). Figure 20.8 plots smoothed time series of inflation and interest rates for the US over this period. To get the smoothed series, we use the HP trend component of each series, similarly to what we did for money growth and inflation in Figure 20.5.

Figure 20.8: Smoothed Inflation and Interest Rates

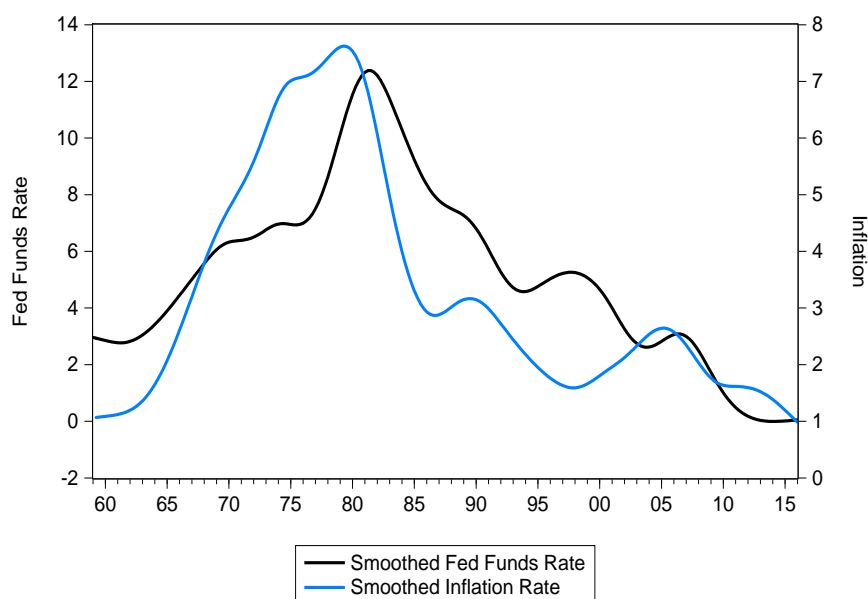

Visually, we can see that these series move together quite strongly. The correlation coefficient between the smoothed interest rate and inflation rate series is 0.76, which is a bit higher than the correlation between the actual series without any smoothing (0.70). From this, we can deduce that the primary determinant of the level of nominal interest rates over a sufficiently long period of time is the inflation rate (which is in turn determined by money growth, among other factors).

An interesting current debate among academics (and policymakers) concerns the connec-

tion between inflation rates and interest rates. As we will see in Part V, standard Keynesian analysis predicts that monetary expansions result in lower interest rates and higher inflation (perhaps with some lag). This is the conventional stabilization view among most people – lowering interest rates increases demand, which puts upward pressure on inflation. An alternative viewpoint, deemed “Neo-Fisherianism” by some, reaches the reverse conclusion. It holds that raising inflation rates requires raising interest rates. The Neo-Fisherian viewpoint is based on the logic laid out in this chapter – if the real interest rate is independent of monetary factors, interest rates and inflation ought to move together. This is certainly what one sees in the data, particularly over longer time horizons. In the very short run, when, as we will see, monetary policy can affect real variables (including the real interest rate), the Neo-Fisherian result may not hold, and lower interest rates may result in higher inflation. In some respect, the debate between Neo-Fisherians and other economists centers on time horizons – in the medium run, the Neo-Fisherian view ought to hold (and does in the data), while in the short run monetary non-neutrality may result in it not holding.

20.4 The Money Supply and Real Variables

The basic neoclassical model makes the stark prediction that money is neutral with respect to real variables – changes in the quantity of money do not impact real GDP or other variables. Does this hold up in the data?

Figure 20.9 plots the cyclical components (obtained from removing an HP trend) of the M2 money supply and real GDP. Visually, it appears as though the money supply and output are positively correlated. For the full sample, the series are in fact positively correlated, albeit relatively weakly. In particular, the correlation between the cyclical components of M2 and GDP is about 0.20.

Figure 20.9: Cyclical Components of Real GDP and the Money Supply

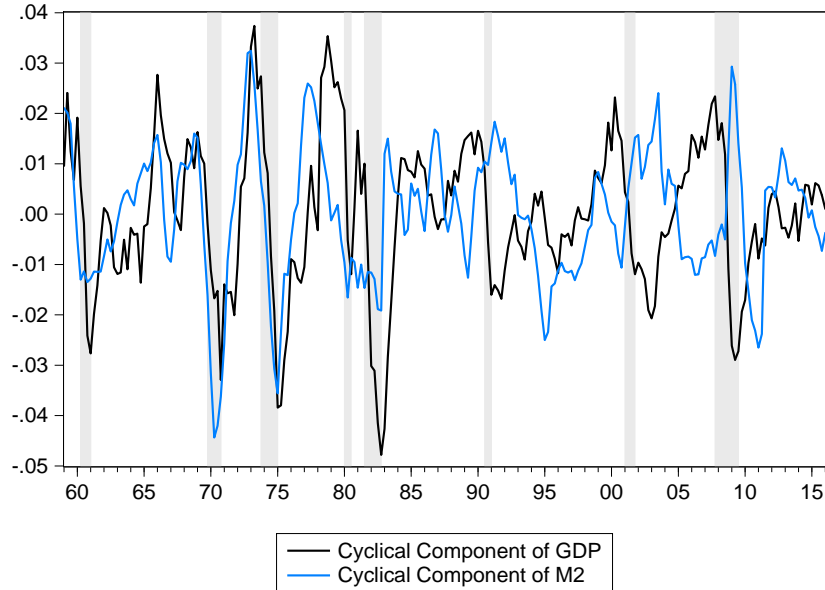

Does the positive correlation (however mild) between the money supply and real GDP indicate that changes in the money supply *cause* changes in real GDP? Not necessarily. Remember that correlation does not imply causation. It could be that the central bank chooses to increase the money supply whenever real GDP increases, for example. This could result in a positive correlation between the series, but would not imply that changes in the money supply cause real GDP to change.

A slightly better, though still imperfect, way to assess whether changes in the money supply cause changes in real GDP is to instead look at dynamic correlations. By dynamic correlations, we mean looking at how the money supply observed in date t correlates with real GDP in date $t + j$, where $j > 0$. Table 20.1 presents correlation of the cyclical component of the M2 money supply with the cyclical component of real GDP lead several periods. The frequency of observation is a quarter.

Table 20.1: Dynamic Correlations between M2 and Output

Variable	Correlation with $\ln M_t$
$\ln Y_t$	0.22
$\ln Y_{t+1}$	0.32
$\ln Y_{t+2}$	0.37
$\ln Y_{t+3}$	0.37
$\ln Y_{t+4}$	0.33
$\ln Y_{t+5}$	0.26
$\ln Y_{t+6}$	0.19
$\ln Y_{t+7}$	0.10
$\ln Y_{t+8}$	0.03

We observe from the table that the period t money supply is positively correlated with the cyclical component of real GDP led several periods. Interestingly, these correlations are larger (about 0.35) when output is led several quarters (up to a year) than the contemporaneous correlation of 0.22. This is suggestive, but only suggestive, that changes in the money supply do impact real GDP. It is only suggestive because it could be that the Fed anticipates that output will be above trend in a year, and increases the money supply in the present in response. While this is a possibility, it seems somewhat unlikely. The fact that these correlations are larger when output is led several periods than the contemporaneous correlation seems to suggest that changes in the money supply do have some causal effect on real GDP. There are more sophisticated statistical techniques to try and determine whether changes in the money supply cause changes in real GDP and other real aggregate variables. Most of these studies do find that changes in the money supply do impact real GDP in a positive manner, though the effects are generally modest. See [Christiano, Eichenbaum, and Evans \(1999\)](#) for more.

Nevertheless, it is interesting to note that the money supply ceases to be strongly correlated with output after about two years (eight quarters). To the extent to which money is non-neutral empirically, it is only so for a couple of years at most. After a period of several years, changes in the money supply do not seem to impact real variables, and monetary neutrality seems to be an empirically valid proposition. This fact forms the basis of our dividing things into the medium run, where the neoclassical model holds and money is neutral, and the short run, which we will study in Part [V](#), where price or wage rigidity can allow increases in the money supply to result in a temporary increase in real GDP and changes in other real variables.

20.5 Summary

- Money is difficult to measure because many different kinds of assets can and do serve as money. Three conventional definitions of the money supply include M1, M2, and M3. M1 is the sum of all currency in circulation and demand deposits. M2 includes M1 plus some assets that are not as liquid as M1 such as money market mutual funds. M3 includes M2 plus institution money market funds and short term repurchase agreements. Economists usually prefer using M1 or M2 as their preferred measure of money supply.
- Central banks can set the monetary base which consists of reserves plus currency in circulation, but can only partially influence the money supply. The money supply is some multiple of the monetary base. This multiple is a function of the reserve requirements set by central bank, banks' willingness to lend out excess reserves, and household preferences for holding currency as opposed to demand deposits.
- Under a conventional money demand function and assuming a constant nominal interest rate, inflation is the difference between the growth in the money supply and the growth in output. Over the long run, output has grown at a roughly constant rate which implies inflation rises one-for-one with growth in the money supply.
- The relationship between growth in the money supply and inflation is positive but relatively weak at quarterly frequencies. However, the trend component of these series is much more highly correlated.
- The quantity equation is an identity. It says that the money supply times the velocity of money equals nominal GDP. The velocity of money is not measured directly, but rather inferred so as to make sure the quantity equation holds. In terms of economics, velocity can be interpreted as the number of times the average unit of money is used. Velocity was relatively constant from 1960-1990, but has been quite volatile since 1990.
- Over the long run, nominal interest rates should move one for one with the inflation rate. In the data there is indeed a strong relationship between these two variables.
- The Neoclassical model predicts that the determination of real variables is independent of nominal variables. In the data, the cyclical component of M2 is positively correlated with cyclical component of output. While this is suggestive evidence against the classical dichotomy, correlation does not imply causation. However, increases in the money supply are also correlated with future increases in output which is stronger evidence against the classical dichotomy.

Key Terms

- Currency
- Asset
- M1
- M2
- M3
- Reserves
- Fractional reserve banking
- Monetary base
- Money multiplier
- Velocity of money
- Neo-Fisherian
- Dynamic correlation

Questions for Review

1. Describe some of the difficulties in measuring the money supply. To what extent do alternative measures of the money supply move together?
2. Do central banks control the money supply?
3. To what extent is inflation a monetary phenomenon?
4. Evaluate the Neoclassical model's prediction about the velocity of money.
5. Evaluate the Neoclassical model's prediction about the correlation between the nominal interest rate and inflation.
6. What evidence is there that changes in the money supply affect output?

Exercises

1. [**Excel Problem**] Download quarterly data on real GDP and M1 from the St. Louis Fed FRED website for the period 1960 through the second quarter of 2015. Our objective here is to examine how the money supply and output are correlated, with an eye towards testing the prediction of the neoclassical model of monetary neutrality.

- (a) Before looking at correlations we need to come up with a way of detrending the series – both the money supply and real output trend up, and correlations are not well-defined for trending series. We will focus on natural logs of the data. We will use a moving average filter. In particular, we will define the “trend” value of each series as a two-sided three year (12 quarter) moving average of the natural log of the data. This involves losing three years of data at both the beginning and end of the sample. Our data sample begins in 1960q1 and ends in 2015q2. Your trend value for a series in 1963q1 will equal the average of the series from 1960q1 to 1966q1 (12 observations before the period in question, and 12 observations after). Your trend value in 1963q2 will equal the average of the series from 1960q2 to 1966q2. Your trend value of a series in 2012q2 will equal the average of the series from periods 2009q2 through 2015q2. And so on. The first observation in your trend series should be 1963q1 and the last should be 2012q2.
- (b) After you have constructed your trend series for both log M1 and log real GDP, define the detrended series as the difference between the log of the actual series and its trend value. You will then have a time series of detrended values of log M1 and log real GDP running from 1963q1 to 2012q2. Plot the detrended values of log M1 and log real GDP against time and show them here. What do you see happening to real GDP around the time of the Great Recession (loosely, 2008 and 2009)? What about detrended M1?
- (c) Compute the correlation coefficient between detrended M1 and detrended output. Does this correlation suggest that money is non-neutral? Why might it not be suggestive of that? Explain.
- (d) Now, to get a better sense of causality, let’s look correlations between M1 and output at different leads. First, compute the correlation between output and M1 led four quarters (i.e. compute the correlation between detrended output from 1963q1 to 2011q2 with the detrended M1 from 1964q1 to 2012q2). Next, compute the correlation between M1 and output led four quarters (i.e. compute the correlation between detrended M1 from 1963q1 to 2011q2 with detrended output from 1964q1 to

2012q2). Are these correlations suggestive that money is non-neutral?
Explain.

Chapter 21

Policy Implications and Criticisms of the Neoclassical Model

In Chapter 15, we showed that a hypothetical benevolent social planner would choose the same allocations of consumption, labor supply, and investment as emerge in a decentralized equilibrium. What we have been doing in Part IV is simply a graphical analysis of the micro-founded equilibrium conditions derived in Part III.

The implication of this analysis is that the equilibrium of the neoclassical model is efficient in the sense of being exactly what a hypothetical benevolent social planner would choose. In other words, it is not possible for aggregate economic policy to improve upon the equilibrium allocations of the neoclassical model. This means that there is no role in the neoclassical model for activist economic policies designed to “smooth” out business cycle fluctuations. If the economy goes into a recession because A_t declines, for example, the recession is efficient – it is not optimal for policy to try to combat it, taking the reduction in A_t as given.

The neoclassical model with which we have been working also goes by the name “Real Business Cycle” (RBC) model. Economists Fynn Kydland and Ed Prescott won a Nobel Prize for developing this model. One can read more about RBC theory [here](#). The model is called “Real” because it features monetary neutrality and emphasizes productivity shocks as the primary source of economic fluctuations. It has the surprising and important policy implication that there is no role for activist economic policies. This was (and is) a controversial proposal.

In this chapter, we (briefly) discuss several criticisms which have been levied at the neoclassical / RBC model, criticisms which may undermine this strong policy proscription.

21.1 Criticisms

In the subsections below we (briefly) lay out several different criticisms of the neoclassical model. Some of these question how well the neoclassical model can fit the data (which we discussed in Chapter 19), some question assumptions in the model, and others point out things which are missing from the model.

21.1.1 Measurement of TFP

A defender of the policy proscriptions which follow from the neoclassical model might say something along the lines of “Well, you might not like the implications of the model, but the model fits the data well. Therefore it is a good model and we ought to take seriously its policy implications.” Several people have questioned just how well the neoclassical model fits the data, beginning with Larry Summers in [Summers \(1986\)](#).

The neoclassical model needs fluctuations in A_t to be the main driving force behind the data in order to qualitatively fit the data well. In [Chapter 19](#), we showed that one could construct a measure of aggregate productivity given observations on Y_t , K_t , and N_t . The resulting empirical measure, which is often called total factor productivity or just TFP, moves around a lot and is highly correlated with output – in periods where Y_t is low, TFP tends to be low, in a way consistent with decreases in A_t causing declines in output.

One of the main areas of criticism of the neoclassical model is that the measure of TFP is only as good as the empirical measures of K_t and N_t . Over sufficiently long time horizons, most economists feel that we have pretty good measures of capital and labor, but what about month-to-month or quarter-to-quarter? Many economists have pointed out that observed inputs might not correspond to the true inputs relevant for production. For example, suppose a firm has ten tractors. One quarter, the firm operates each tractor for 18 hours a day. The next quarter, the firm operates the tractors only 9 hours a day. To an outside observer, the firm’s capital input will be the same in both quarters (ten tractors), but the effective capital input is quite different in each quarter, because in the first quarter the tractors are more intensively utilized than in the second quarter. To the extent to which effective capital and labor inputs are mismeasured, what is measured as TFP may not correspond to the concept of A_t in the model.

To be concrete, suppose that the aggregate production function is given by:

$$Y_t = A_t (u_t K_t)^\alpha N_t^{1-\alpha} \quad (21.1)$$

Here, u_t is capital utilization (in terms of the example given above, one might think of this as representing the number of hours each unit of capital is used). With this production function, what one measures in the data as TFP will be:

$$\ln TFP_t = \ln A_t + \alpha \ln u_t \quad (21.2)$$

In other words, if the utilization of capital moves around, measured TFP will *not* correspond one-to-one to the exogenous variable A_t in the model. One can see why this

might matter. Suppose that there is an increase in the demand for a firm’s product. The firm chooses to work its capital harder, increasing u_t . This results in higher output. One will then observe TFP being high at the same time output is high, and might falsely attribute it to A_t being, though in this example A_t is not high – output is high because demand is high.

How important might this problem be in practice? While most economists think that the utilization ought to be fairly stable over long time horizons, in the short run it might move around quite a bit. [Basu, Fernald, and Kimball \(2006\)](#) argue that this problem is important. They come up with a way to measure utilization and “correct” a traditional measure of TFP for it. They find that the corrected TFP measure is close to uncorrelated with output, which suggests that utilization moves around quite a bit. John Fernald of the Federal Reserve Bank of San Francisco maintains an updated, quarterly measure of the corrected TFP series. [Figure 21.1](#) below plots the cyclical component of output along with the cyclical component of the adjusted TFP series

Figure 21.1: Cyclical Components of GDP and Utilization-Adjusted TFP

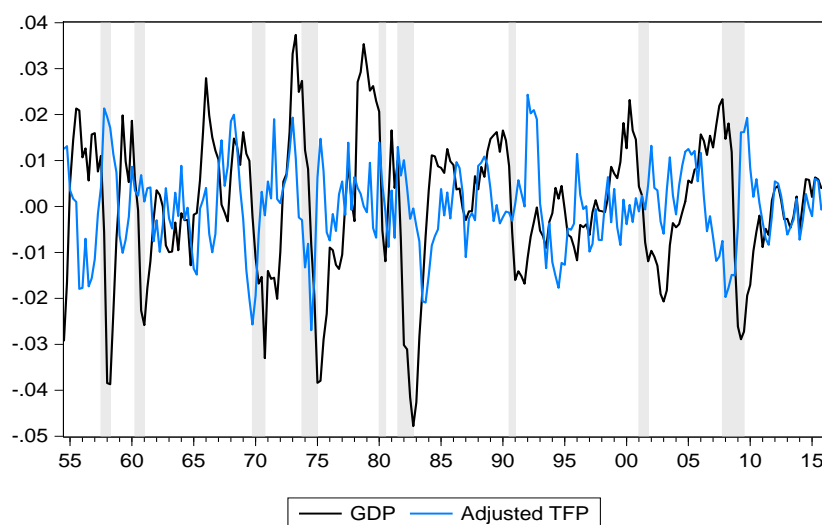

It is instructive to compare this figure with [Figure 19.3](#). Whereas the conventional TFP series is highly correlated with output, it is clear here that the corrected TFP series is not. In particular, the correlation coefficient between the corrected TFP series and output is -0.13. In [Figure 21.1](#), one can see many periods which are near recessions but in which corrected TFP is high and/or rising. To the extent to which the corrected TFP series accurately measures the model concept of A_t (it may not, for a variety of reasons), this is a problem for the neoclassical theory of business cycles. For the model to match co-movements in the data, it needs to be driven by changes in A_t . If changes in A_t do not line up with observed changes in Y_t , then the model is missing some important ingredient, and one should be weary about

taking its policy implications too seriously.

21.1.2 What are these Productivity Shocks?

One might dismiss the corrected version of TFP as being wrong on some dimension, or in attributing too much of the variation in observed TFP to utilization. Nevertheless, there remains a nagging question: what exactly are these productivity shocks causing output to move around?

One can phrase this question in a slightly different way. If there is a big, negative productivity shock which causes output to decline, why can't we read about that in the newspaper? Another question is: what does it mean for productivity to decline? To the extent to which one thinks about productivity as measuring things like knowledge, how can it decline? Do we forget things we once knew? These questions do not have simple answers, and have long left many uncomfortable with real business cycle theory.

21.1.3 Other Quantitative Considerations

In Chapter 19, we focused only on the ability of the model to qualitatively capture co-movements of different aggregate variables with output. In more sophisticated versions of the model which are taken to a computer, one can also look at how volatile different series are (i.e. what their standard deviations are) and compare that with what we see in the data.

While the neoclassical model successfully predicts that output and labor input are strongly positively correlated, it has difficulty in matching the relative volatility of hours. In the data, total hours worked is about as volatile as total output (i.e. they have roughly the same standard deviations). The basic model has great difficulty in matching this – in quantitative simulations of the model, total hours usually ends up about half as volatile as output. Put another way, the model seems to be missing some feature which drives the large swings in aggregate labor input we observe in the data.

21.1.4 An Idealized Description of the Labor Market

The labor market in the neoclassical model is particularly simplistic. There is one kind of labor input, and this labor input is supplied by a representative household in a competitive spot market. There is no attachment between workers and firms, there is nothing like on the job training or human capital acquisition, and there is no unemployment as it is defined in the national accounts (indeed, taken literally our model predicts that all movements in labor input are along the intensive margin, i.e. hours of work instead of whether or not to work). It

is possible to write down versions of the model with a more sophisticated description of the labor market, but it is difficult to adequately model the richness of real-world labor markets.

21.1.5 Monetary Neutrality

The basic neoclassical model features the classical dichotomy and the neutrality of money. Nominal shocks have no real effects, and there is no role for monetary policy to try to react to changing economic conditions.

Evidence presented in Chapter 20 casts doubt on the assumption that money is completely neutral, at least over short horizons. In particular, we showed that the cyclical component of the aggregate money supply is positively correlated with the cyclical component of output led over several quarters. While not dispositive, this is at least strongly suggestive that changes in the money supply have real effects. A large body of research supports that money is indeed non-neutral, although most of this research suggests that the real effects of money are not particularly large and not particularly long-lasting. The notion of monetary neutrality also seems to run counter to our every day experience. People seem to think that what central banks do matters in ways beyond affecting the price level and inflation rate.

21.1.6 The Role of Other Demand Shocks

The basic neoclassical model, as we have written it, has output being completely supply determined. This means that only changes in A_t or θ_t can impact output. There is no role for other demand side disturbances (i.e. shocks to the IS curve), such as changes in G_t , G_{t+1} , or A_{t+1} . The model can be amended in such a way that these shocks can impact output by permitting the real interest rate to impact labor supply (as was discussed briefly in Chapter 12 and as is developed in more detail in Appendix C). With such a modification, the effects of demand shocks on output are nevertheless small, and the model has difficulty generate positive co-movement between consumption and labor input conditional on demand-side shocks.

Both casual experience and academic research suggests that demand shocks might be important drivers of output, at least in the short run. For example, a large body of research tries to estimate the government spending multiplier. Most of this research finds that the multiplier is positive (i.e. increases in G_t cause Y_t to increase), though the literature is divided on whether the multiplier is greater than or less than one. Other work looks at how news or optimism about the future (e.g. anticipated changes in A_{t+1}) might impact output.

21.1.7 Perfect Financial Markets

The basic neoclassical model does not have much to say about financial intermediation. In the setup we have pursued, the household saves through a financial intermediary (i.e. a bank), and this intermediary funnels these savings to the representative firm for investment in productive capital. The interest rate on savings and investment are the same, and the solution to the model would be equivalent if the firm instead financed itself with equity instead of debt.

In reality financial markets seem to be imperfect, and interest rates relevant for investment are often quite different than what a household can safely earn on its savings. Figure 21.2 below plots an empirical measure *credit spreads*, defined as the spread between the Baa rated corporate bond rate and the interest rate on a Treasury note of 10 year maturity. We can see that the credit spread tends to rise in periods identified as recessions (as demarcated with gray shaded bars), and seem to co-move negatively with output. Indeed, in the data since the early 1950s, the correlation between the cyclical (HP filtered) component of real GDP and the Baa credit spread is almost -0.4. One might interpret the credit spread as a measure of the health of financial intermediation, and the countercyclicality of the observed credit spread in the data seemingly suggests that financial intermediation works poorly during recessions. This certainly aligns with conventional wisdom concerning the recent Great Recession.

Figure 21.2: Cyclical Components of GDP and Baa Credit Spread

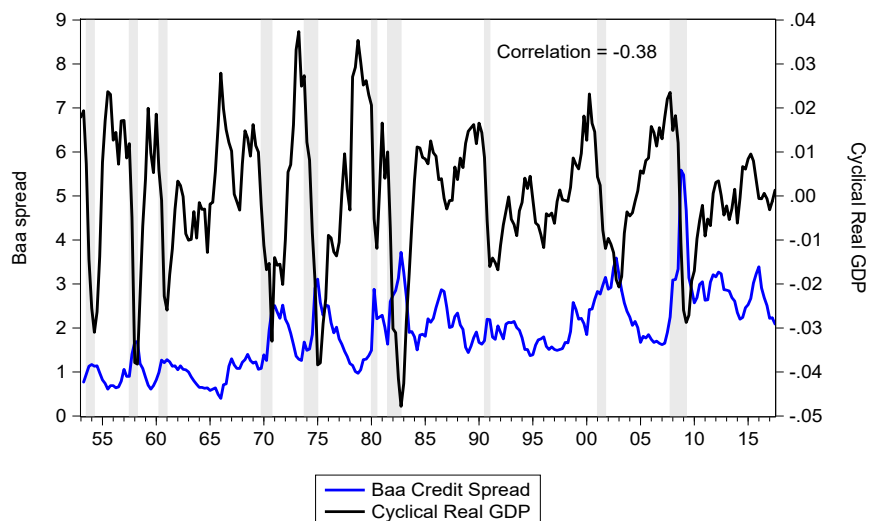

The basic neoclassical model does not allow us to meaningfully address financial market imperfections or the role of credit spread shocks. We will take this up later in the book in Part VI.

21.1.8 An Absence of Heterogeneity

The basic neoclassical model with which we have been working features a representative household and firm – there is no interesting heterogeneity. In the real world, there is lots of heterogeneity – some households earn substantially more income than others, for example.

By abstracting from heterogeneity, the neoclassical model may substantially understate the welfare costs of recessions, and might therefore give misleading policy implications. In a typical recession in the data, output falls by a couple of percentage points relative to trend. If everyone’s income in the economy fell by a couple of percentage points, no one would like this but it wouldn’t be that big of a deal. In the real world, recessions tend to impact individuals differently. Some people see their income drop a lot (say, because they lose a job), whereas others see virtually no change in their income. If there is imperfect insurance across households, then the utility of the individuals hardest hit will decline by a lot, whereas the utility of those who are not affected will be unchanged or will decline only little. A benevolent planner may desire to redistribute resources from the unaffected households to the affected households (e.g. those households who lose their jobs). To the extent to which this redistribution is difficult/impossible, the planner may prefer to fight recessions with stimulative policies of one sort or the other. Because the neoclassical model abstracts from heterogeneity, it cannot successfully speak to these issues, and its policy implications may therefore be misguided.

21.2 A Defense of the Neoclassical Model

The basic neoclassical model is fully based on microeconomic decision-making. It takes dynamics and forward-looking behavior seriously. It is therefore immune from many of the criticisms levied by economists during the 1970s against the macroeconomic models of the middle of the 20th century. The neoclassical model can potentially fit the data well in a qualitative sense if it is predominantly driven by changes in productivity. It has the stark policy implication that there is no need for aggregate economic policy to try to smooth out business cycle fluctuations.

As we have documented here, the neoclassical model, for all its desirable features and potential empirical successes, is not immune from criticism. Our own view is that these criticisms have much merit, and that the neoclassical model is probably not a good framework for thinking about economic fluctuations in the short run. Why then, have we spent so much space of this book working through the neoclassical model? It is because the neoclassical model is a good *benchmark* model for thinking about fluctuations, and it provides a good description of the data over longer time horizons, what we have deemed the “medium run”

(periods of a couple to several years).

When thinking about building a better model for short run fluctuations, one needs to clearly articulate the deviation from the neoclassical benchmark. In practice, this is how modern macroeconomics is done. A phrase commonly used is that “it takes a model to beat a model.” The neoclassical model serves as the “backbone” for virtually all short run macroeconomic models. Models designed to understand short run fluctuations introduce one or more “twists” to the neoclassical model. These “twists” are usually only operative for up to a couple of years. Keynesian models, which are the most popular alternative to the neoclassical model, assume that, in the short run, prices and/or wages are imperfectly flexible. As we will see in more depth in Part V, this short run “stickiness” will change the behavior of the model and alter its policy implications in an important way.

Most economists agree that prices and/or wages are subject to some level of “stickiness” in the short run. Where they differ is in how important this stickiness is and how long it lasts – in other words, part of the disagreement is over how long the short run is. Neoclassical economists (sometimes called “freshwater” economists) tend to think that nominal stickiness is not that important and does not last that long. They prefer to use the neoclassical model (or some close variant thereof) to think about short run fluctuations. Keynesian economists (or sometimes “saltwater”) think that nominal stickiness is important and might last a very long time. While most Keynesian economists would agree that the neoclassical model is a good benchmark for understanding medium run movements in output and other quantities, they feel that nominal stickiness means that the economy can deviate from this neoclassical benchmark by a significant amount and for a significant length of time. As such, they prefer to use Keynesian models to understand short run fluctuations. We will study these models in Part V.

21.3 Summary

- The Neoclassical model, also known as the Real Business Cycle model, makes the stark proposition that business cycles are optimal in the sense that a government cannot make people better off by following some activist policy. In fact, activist policy can only make people worse off. This is a controversial idea.
- One criticism is that measured TFP poorly captures productivity. If input utilization varies over the business cycle, measured TFP will be mis-specified. Measures of TFP that correct for input utilization show that TFP and output have a much lower, and possibly even negative, correlation.

- Also, no one knows what TFP really is. To the extent it measures something like technology or knowledge, what does it mean for TFP to decline?
- The Neoclassical model is also criticized because it predicts monetary neutrality. This runs counter to the evidence discussed in [20](#).
- Academic research shows that demand shocks are an important determinant of short-run output fluctuations. However, the Neoclassical model predicts that output is invariant to demand shocks.
- Finally, the Neoclassical model has no heterogeneity. This is a problem because the burden of recessions is not shared equally. Some people do not lose anything at all while others lose their jobs. By abstracting from this heterogeneity there is no role for redistribution or fiscal policy that may substitute for redistribution.
- These criticisms have merit and taken together imply that the Neoclassical model may not be the best model for business cycles. However, it is a useful benchmark and does a good job describing the economy over the medium run.

Key Terms

- Variable utilization
- Corrected TFP series
- Freshwater economist
- Saltwater economist

Questions for Review

1. Evaluate the following statement: Because there is no role for activist policy in the Neoclassical model, declines in productivity are welfare improving.
2. Why might measured TFP be an incorrect measure of true productivity?
3. What is concerning about excluding meaningful heterogeneity in the Neoclassical model?

Chapter 22

Open Economy Version of the Neoclassical Model

In this chapter we consider an open economy version of the neoclassical model. This introduces a new expenditure category, net exports, which we will denote NX_t . Net exports is the difference between exports (stuff produced in an economy and sold elsewhere) and imports (stuff produced elsewhere but purchased in an economy of interest). As we discussed in Chapter 1, the reason that imports gets subtracted off is because the other expenditure categories (consumption, investment, and government spending) do not discriminate on where a good was produced. Hence, a household buying a foreign good increases consumption, but does not affect total domestic spending, so subtracting off imports is necessary for the positive entry in consumption to not show up in total aggregate expenditure.

For simplicity, we will think of a world with two countries – the “home” country (the country whose economy we are studying) and the foreign economy, which we take to represent the rest of the world. Net exports depends on the real exchange rate, which governs the terms of trade between domestic and foreign goods. In real terms, this exchange rate measures how many “home” goods one foreign good will purchase (in contrast, the nominal exchange rate measures how many units of “home” currency one unit of foreign currency will purchase). Because of international mobility of capital, the real exchange rate will depend on the real interest rate differential between the home and foreign economies. This means that net exports will in turn depend on the real interest rate differential, where we take the foreign real interest rate as given. In effect, the opening of the economy will just add another term to the expenditure identity (which manifests graphically in terms of the IS curve) which depends negatively on the real interest rate.

22.1 Exports, Imports, and Exchange Rates

In this section, we introduce a foreign sector into our neoclassical model of an economy. This introduces a new expenditure category, net exports, which we will denote NX_t . Net exports is the difference between exports (goods and services produced in the home country and sold to foreigners) and imports (goods and services produced abroad and purchased by domestic residents). Net exports in turn depends on the real exchange rate, which is the

relative price of home and foreign produced goods. In what follows, we will think of the country whose economy we are modeling as the “home” country (where relevant, denoted with a h superscript) and will simply model all other foreign countries as one conglomerate foreign country (where relevant, denoted with a F superscript). We will sometimes also refer to the foreign sector as the “rest of the world.”

Total desired expenditure on home production is the sum of desired expenditure by the household, C_t^h , the firm on investment, I_t^h , and the government, G_t^h . There is an additional term, X_t , which stands for exports. Exports represent expenditure by the rest of the world on home-produced goods and services. Total desired expenditure on home-produced goods and services is the sum of these four components, as given in (22.1).

$$Y_t^d = C_t^h + I_t^h + G_t^h + X_t \quad (22.1)$$

The household can consume goods either produced at home or abroad and similarly for the firm doing investment and government expenditure. That is, total consumption, investment, and government expenditure are the sums of home and foreign components:

$$C_t = C_t^h + C_t^F \quad (22.2)$$

$$G_t = G_t^h + G_t^F \quad (22.3)$$

$$I_t = I_t^h + I_t^F \quad (22.4)$$

If we plug these in to (22.1) and re-arrange terms, we get:

$$Y_t^d = C_t + I_t + G_t + X_t - (C_t^F + I_t^F + G_t^F) \quad (22.5)$$

We will refer to the term $C_t^F + I_t^F + G_t^F$ in (22.5) as imports – this term denotes total desired expenditure by home residents on foreign produce goods and services. Labeling this term IM_t , (22.5) can be written:

$$Y_t^d = C_t + I_t + G_t + X_t - IM_t \quad (22.6)$$

Or, defining $NX_t = X_t - IM_t$:

$$Y_t^d = C_t + I_t + G_t + NX_t \quad (22.7)$$

We assume that total desired consumption and investment are the given by the same functions we have previously used:

$$C_t = C^d(Y_t - G_t, Y_{t+1} - G_{t+1}, r_t) \quad (22.8)$$

$$I_t = I^d(r_t, A_{t+1}, K_t) \quad (22.9)$$

Consumption is an increasing function of current and future perceived net income (it is perceived because we continue to assume that Ricardian Equivalence holds, so that the household behaves as though the government balances its budget each period) and a decreasing function of the real interest rate. Investment is a decreasing function of the real interest rate, an increasing function of expected future productivity, and a decreasing function of the existing capital stock, K_t . We continue to assume that government spending is exogenous with respect to the model.

What determines desired net exports? Mechanically, net exports depends on how much foreign stuff home residents want to purchase less how much home stuff foreigners want to purchase. In principle, this difference depends on many factors. One critical factor is the real exchange rate, which measures the relative price of home produced goods to foreign produced goods. We will denote the real exchange rate by ϵ_t . This is simply a relative price between home and foreign produced goods, and the units are $\frac{\text{home goods}}{\text{foreign goods}}$. So if the real exchange rate is 1, one unit of a foreign good will purchase one home produced good. Exchange rates can be tricky in that the relative price of goods can be defined in the opposite way (i.e. foreign goods to domestic goods). We will always think of the real exchange rate as being denoted home goods relative to foreign goods.

The building block of the real exchange rate is the nominal exchange rate, which we will denote by e_t . The nominal exchange rate measures how many units of the home currency one unit of foreign currency can purchase. As an example, if the units of the domestic currency are dollars, and the units of the foreign currency are euros, then the nominal exchange rate is dollars per euro. If the nominal exchange rate is 2, it says that one euro will purchase 2 dollars. If the exchange rate were defined in the other way, it would be $1/2$, and would say that one dollar will purchase half of a euro.

The real and nominal exchange rates are connected via the following identity:

$$\epsilon_t = e_t \frac{P_t^F}{P_t} \quad (22.10)$$

Here, P_t^F is the nominal price of foreign goods and P_t is the nominal price of home goods. The logic embodied in (22.10) is as follows. ϵ_t measures how many home goods can be purchased with one foreign good. One foreign good requires P_t^F units of foreign currency. This P_t^F units of foreign currency purchases $e_t P_t^F$ units of the home currency (since the units

of e_t are home currency divided by foreign currency, $e_t P_t^F$ is denominated in units of home currency). $e_t P_t^F$ units of home currency will purchase $\frac{e_t P_t^F}{P_t}$ units of home goods.

We assume that desired net exports depend *positively* on the real exchange rate. Why is this? If ϵ_t increases, then foreign goods will purchase relatively more home goods (and vice-versa). Put differently, home goods are relatively cheap for foreigners, and foreign goods are relatively expensive for home residents. This will tend to make exports rise (the home country will sell more of its relatively cheaper goods abroad) and imports will fall (home residents will buy relatively fewer foreign goods, since these are now more expensive). We say that an increase in ϵ_t so defined represents a real depreciation of home goods (home goods are relatively cheaper for foreigners). Thus, we assume that net exports are increasing in ϵ_t . We will not model other sources of fluctuations in net exports (which could include changes in home or foreign income, etc.), but will instead use an exogenous variable to denote all other sources of change in desired net exports. We will denote this exogenous variable as Q_t . We will normalize it such that an increase in Q_t results in an increase in desired net exports (and vice-versa for a decrease in Q_t). One source of changes in Q_t could be tariffs and other barriers to trade or trade unions and agreements that lower barriers to trade.

Now, what determines the real exchange rate, ϵ_t ? We will assume that the real exchange rate depends on the differential between the home and foreign real interest rates, $r_t - r_t^F$, where r_t^F denotes the foreign real interest rate (which we take to be exogenous in the model). Why is this? If $r_t > r_t^F$, one earns a higher real return on saving in the home country than in the foreign country. This ought to drive up the demand for home goods relative to foreign goods, which would result in a reduction in ϵ_t , what we would call a home appreciation (and vice versa). Hence, the real exchange rate itself ought to be decreasing function of the real interest differential between the home country and the rest of the world. In particular, we will assume:

$$\epsilon_t = h(r_t - r_t^F) \tag{22.11}$$

Here, $h(\cdot)$ is some unknown but decreasing function, i.e. $h'(\cdot) < 0$. This specification omits other factors which might influence the real exchange but focuses on one of the most important that is relevant to the rest of our model. Since net exports are assumed to be increasing in ϵ_t , but ϵ_t is decreasing in the real interest rate differential, we can conclude that net exports are decreasing in the real interest rate differential between the home and foreign country. Formally:

$$NX_t = NX^d(r_t - r_t^F, Q_t) \tag{22.12}$$

The + and – signs indicate the net exports is decreasing in the real interest rate differential and is increasing in the exogenous variable Q_t , which is meant as a stand-in for anything else which might influence net exports. The demand side of the open economy version of the neoclassical model is therefore characterized by the following equations:

$$C_t = C^d(Y_t - G_t, Y_{t+1} - G_{t+1}, r_t) \quad (22.13)$$

$$I_t = I^d(r_t, A_{t+1}, K_t) \quad (22.14)$$

$$NX_t = NX^d(r_t - r_t^F, Q_t) \quad (22.15)$$

$$Y_t = C_t + I_t + G_t + NX_t \quad (22.16)$$

Expressions (22.13)-(22.15) are the demand functions for consumption, investment, and net exports, respectively. Expression (22.16) is simply the aggregate resource constraint, which takes (22.7) and imposes that income equal expenditure.

The supply side of the neoclassical model is completely unaffected by the economy being open. The supply side is characterized by the same labor demand and supply curves and aggregate production function assumed earlier:

$$N_t = N^s(w_t, \theta_t) \quad (22.17)$$

$$N_t = N^d(w_t, A_t, K_t) \quad (22.18)$$

$$Y_t = A_t F(K_t, N_t) \quad (22.19)$$

(22.17) is the labor supply curve, (22.18) is the labor demand curve, and (22.19) is the aggregate production function.

In addition to these expressions, we also have the familiar money demand curve and Fisher relationship:

$$M_t = P_t M^d(r_t + \pi_{t+1}^e, Y_t) \quad (22.20)$$

$$r_t = i_t - \pi_{t+1}^e \quad (22.21)$$

Finally, we also have the the condition relating the real interest rate differential to the real exchange rate and the condition relating the real exchange rate to the nominal exchange rate:

$$\epsilon_t = h(r_t - r_t^F) \quad (22.22)$$

$$e_t = \epsilon_t \frac{P_t}{P_t^F} \quad (22.23)$$

We take all foreign variables, r_t^F and P_t^F , as given (and hence exogenous, i.e. determined outside of our model). The full set of mathematical conditions characterizing the equilibrium of the neoclassical model is given below:

$$C_t = C^d(Y_t - G_t, Y_{t+1} - G_{t+1}, r_t) \quad (22.24)$$

$$I_t = I^d(r_t, A_{t+1}, K_t) \quad (22.25)$$

$$NX_t = NX^d(r_t - r_t^F, Q_t) \quad (22.26)$$

$$Y_t = C_t + I_t + G_t + NX_t \quad (22.27)$$

$$N_t = N^s(w_t, \theta_t) \quad (22.28)$$

$$N_t = N^d(w_t, A_t, K_t) \quad (22.29)$$

$$Y_t = A_t F(K_t, N_t) \quad (22.30)$$

$$M_t = P_t M^d(r_t + \pi_{t+1}^e, Y_t) \quad (22.31)$$

$$r_t = i_t - \pi_{t+1}^e \quad (22.32)$$

$$\epsilon_t = h(r_t - r_t^F) \quad (22.33)$$

$$e_t = \epsilon_t \frac{P_t}{P_t^F} \quad (22.34)$$

This is now eleven equations in eleven endogenous variables – the endogenous quantities are Y_t , C_t , I_t , NX_t , and N_t ; the endogenous real prices are r_t , w_t , and ϵ_t ; and the endogenous nominal prices are P_t , i_t , and e_t . These are the same endogenous variables we encountered before, but with the addition of NX_t , ϵ_t , and e_t . The exogenous variables are A_t , A_{t+1} , G_t , G_{t+1} , K_t , M_t , π_{t+1}^e , r_t^F , Q_t , and P_t^F . These are the same exogenous variables we had before, but with the inclusion of r_t^F , Q_t , and P_t^F .

22.2 Graphically Characterizing the Equilibrium

As we have done previously, we can graphically characterize the equilibrium of neoclassical model. To make things as close as possible to what we have done earlier, we will focus first on a graphical depiction of the first seven of the equations given in (22.24)-(22.30). The supply side of the model is identical to before, and so we will not rehash that here. We will again characterize the demand side with the IS curve. The IS curve will look qualitatively

the same as we earlier encountered, but will be flatter when the economy is open compared to when it is closed.

We begin with a derivation of the IS curve in the open economy version of the neoclassical model. Total desired expenditure is given by:

$$Y_t^d = C^d(Y_t - G_t, Y_{t+1} - G_{t+1}, r_t) + I^d(r_t, A_{t+1}, K_t) + G_t + NX^d(r_t - r_t^F, Q_t) \quad (22.35)$$

This is simply the aggregate resource constraint, (22.27), without imposing the equality between income and expenditure, combined with the optimal demand functions for the different components of aggregate expenditure. We define total autonomous expenditure as what desired expenditure would be if there were zero current income, i.e. $Y_t = 0$:

$$E_0 = C^d(-G_t, Y_{t+1} - G_{t+1}, r_t) + I^d(r_t, A_{t+1}, K_t) + G_t + NX^d(r_t - r_t^F, Q_t) \quad (22.36)$$

As we did earlier, we assume that total autonomous expenditure, given in (22.36), is positive. This means that, in a plot of Y_t^d against Y_t , the vertical axis intercept is positive. As Y_t increases, Y_t^d increases because of the influence of Y_t on desired consumption. Because the MPC is less than 1, the expenditure line will be positively sloped but with slope less than one.

In addition to exogenous variables, the level of autonomous expenditure (and hence the vertical axis intercept of the expenditure line) depends on the real interest rate. In the upper panel of Figure 22.1, we plot an expenditure line defined for a given real interest rate of $r_{0,t}$. There is a unique point where the expenditure line crosses a 45 degree line showing all points where $Y_t^d = Y_t$. Suppose that the real interest rate increases to $r_{1,t} > r_{0,t}$. This causes autonomous expenditure to decrease, shifting down to the blue line in Figure 22.1. Autonomous expenditure decreases with the real interest rate now for three reasons. The first two are the same as in the basic closed economy neoclassical model – consumption and investment are decreasing functions of r_t . But now net exports, also a component of desired expenditure, is decreasing in the real interest rate. If we find the new level of Y_t where $Y_t^d = Y_t$ after the increase in r_t and connect the dots, we get a downward-sloping IS curve in (r_t, Y_t) space. This is shown by the black line in the lower panel of Figure 22.1 and is labeled IS^{op} .

Figure 22.1: IS Curve: Open vs. Closed Economy

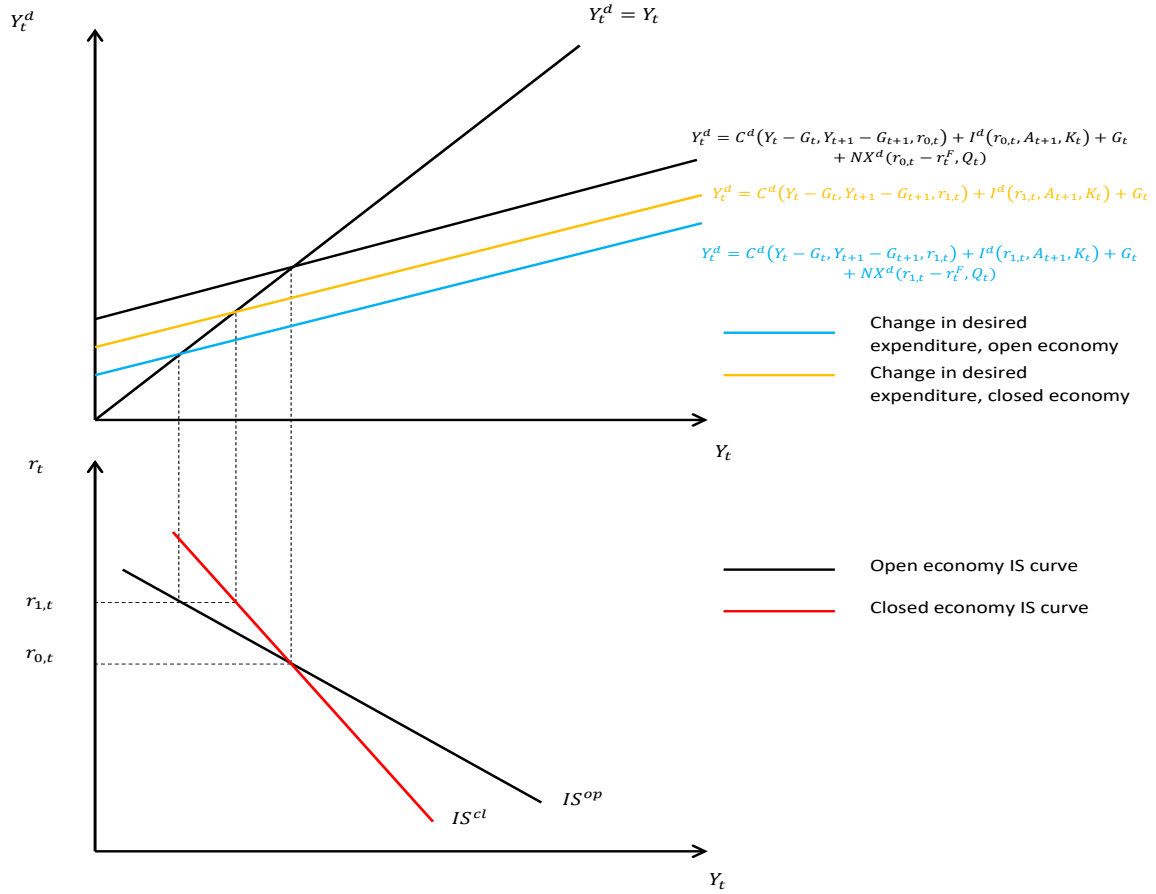

For point of comparison, in Figure 22.1 we have also considered what the IS curve would look like if the economy were closed (i.e. if $NX_t = 0$ and fixed). When r_t increases from $r_{0,t}$ to $r_{1,t}$, the expenditure line shifts down, but by less than it does in the open economy version (since desired net exports do not decline if the economy is closed). We show this with the orange expenditure line. Tracing the points down, we see that the Y_t where income equals expenditure falls by less for a given increase in r_t when the economy is closed compared to when it is open. Connecting the dots, we can conclude that the *IS curve is flatter in the open economy than in the closed economy*. We can see this with the red IS curve labeled IS^{cl} in the figure.

An extreme version of the open economy model is what is called the *small open economy model*. In this model, we assume that the real exchange rate is infinitely elastic with respect to the real interest rate differential; i.e. $h'(r_t - r_t^F) = -\infty$. This means that any small deviation of r_t from r_t^F will cause ϵ_t to increase or decrease by a very large amount, which will in turn trigger a very large change in desired net exports. An increase in r_t would trigger a very large downward-shift in desired expenditure (and the converse for a decrease in r_t), which would

make the IS curve very flat (in the limiting case, completely horizontal). Put somewhat differently, as $h'(r_t - r_t^F) \rightarrow -\infty$, it must be the case that $r_t = r_t^F$ to have desired expenditure not be plus or minus infinity. Hence, in a small open economy model, it must be that $r_t = r_t^F$, and the IS curve becomes flat. The IS curve in the small open economy model is depicted graphically below:

Figure 22.2: IS Curve: Small Open Economy

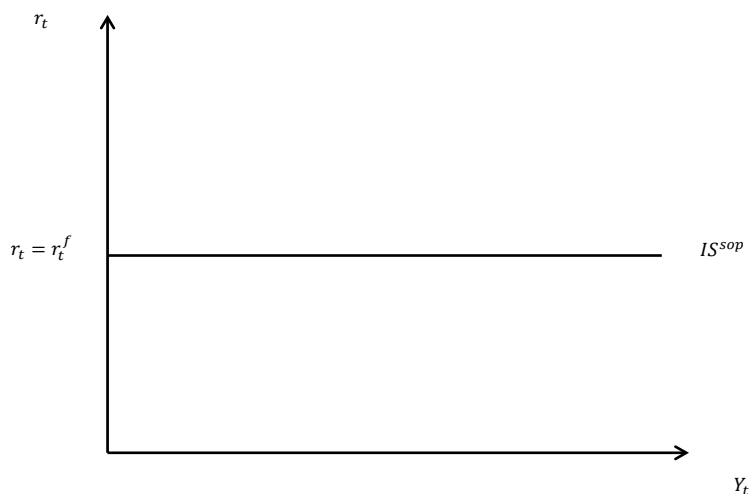

This version of the model is often called the small open economy model because in a small economy it will be impossible for the real interest rate to differ from the rest of the world. Any interest rate differential would cause capital to either enter or leave the country which would in turn cause the real exchange rate to move dramatically. In a larger economy, like the US, the real interest rate need not equal what it is elsewhere in the world. Real interest rate differentials will drive exchange rate movements, but these will not be so large as to make the IS curve perfectly horizontal. Unless otherwise noted, we will work with the model where the open economy IS curve is downward-sloping (not perfectly horizontal), but it is nevertheless flatter than the corresponding closed economy IS curve. The small open economy version of the model is simply an extreme version of this.

In the open economy version of the model, the IS curve will shift if any exogenous variable changes which causes autonomous expenditure to change. This includes the same exogenous variables from the closed economy version of the model – changes in A_{t+1} , G_t , G_{t+1} , or K_t – but now also includes changes in r_t^F or Q_t . If one of the A_{t+1} , G_t , G_{t+1} , or K_t were to change, the IS curve would shift by the same amount horizontally in either the open or closed economy versions of the model. This is depicted in Figure 22.3 below, where we consider an increase in G_t (an increase in A_{t+1} or a reduction in G_{t+1} would produce qualitatively the

same figure). Autonomous expenditure rises (by the same amount) in either an open or a closed economy, shifting the desired expenditure line up. This results in a higher value of Y_t , holding r_t fixed, where income equals expenditure, and results in the IS curve shifting out to the right, as shown in the graph. The horizontal shift of the IS curve does not depend on whether the economy is open or closed. But since the open economy version of the model features a flatter IS curve than the closed economy version, the *vertical* shift is larger in the closed economy version than in the open economy version. This fact is important for thinking about how much the real interest rate will adjust in response to shocks once the IS curve is combined with the Y^s curve to fully characterize the equilibrium.

Figure 22.3: Shift of IS Curve due to $\uparrow G_t$: Open vs. Closed Economy

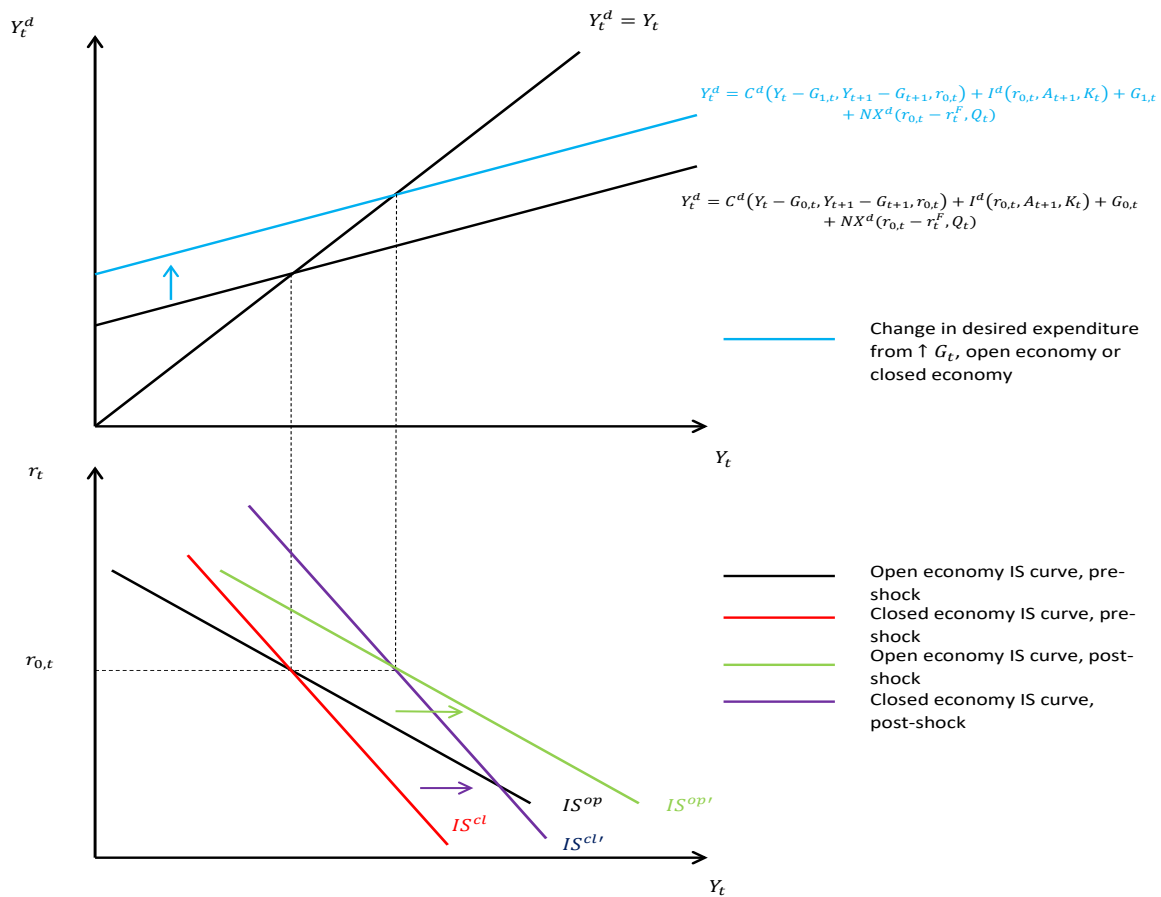

The two new variables which will shift the IS curve are r_t^F and Q_t . An increase in r_t^F will lower the real interest rate differential, which will result in a higher exchange rate. This will result in a real depreciation of the home currency, which means that NX will rise, which will shift the IS curve out to the right. An increase in Q_t will also cause net exports to rise, shifting the IS curve to the right.

As noted above, the supply side of the economy is the same in the open and closed versions of the neoclassical model. The Y^s curve is the set of (r_t, Y_t) pairs consistent with the labor market being in equilibrium and being on the production function. As such, the Y^s curve is vertical.

We can use the same five part graph to graphically determine Y_t , r_t , w_t , and N_t as in the closed economy. This is depicted in Figure 22.4 below. Qualitatively, it looks the same as in the closed economy, though note the inclusion of net exports means that the IS curve is flatter in comparison to a closed economy model and there are two additional exogenous variables which will shift the IS curve (r_t^F and Q_t).

Figure 22.4: $IS - Y^s$ Equilibrium

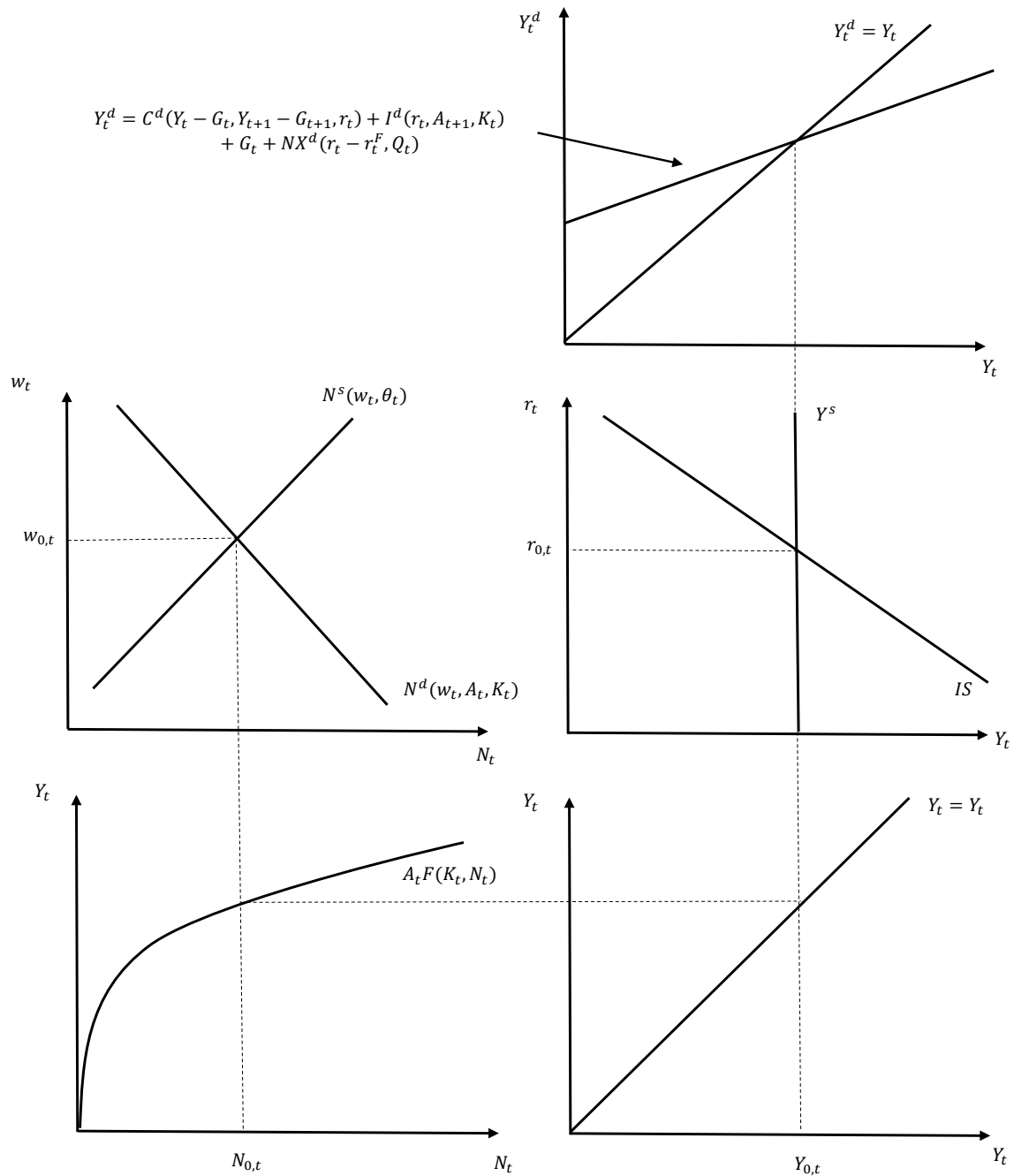

Once the equilibrium values of Y_t and r_t have been determined, the price level can be determined where the money demand curve (whose position depends on r_t and Y_t) crosses the exogenous money supply curve. This is shown graphically in Figure 22.5:

Figure 22.5: Equilibrium in the Money Market

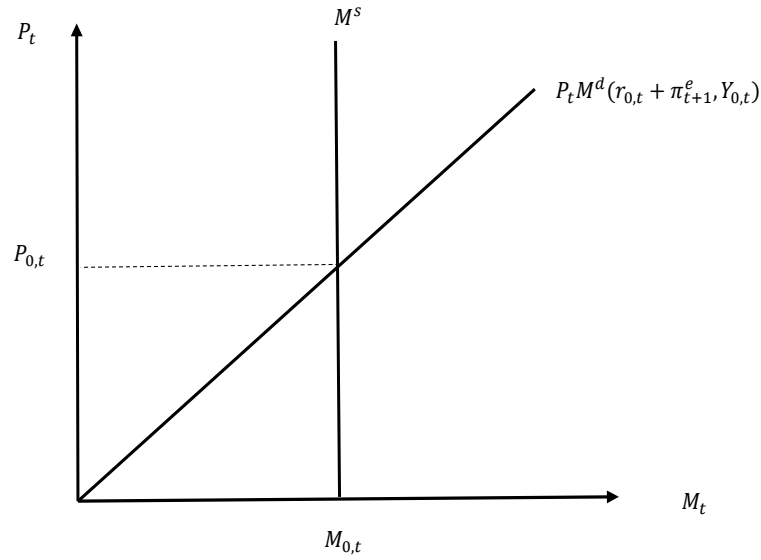

Once r_t is known, given an exogenous expectation of future inflation, the nominal interest rate, i_t , is known. Once r_t is known, the real exchange rate can be determined by (22.33) given the exogenous foreign real interest rate, r_t^f . We can do this graphically. In particular, ε_t is a decreasing function of the real interest rate differential, $\varepsilon_t = h(r_t - r_t^f)$. Given r_t and r_t^f , we can graphically determine the equilibrium real exchange rate where a plot of $h(r_t - r_t^f)$ (which is downward-sloping) crosses a vertical line at $r_{0,t} - r_{0,t}^f$. This is shown in Figure 22.6 below.

Figure 22.6: Equilibrium Real Exchange Rate

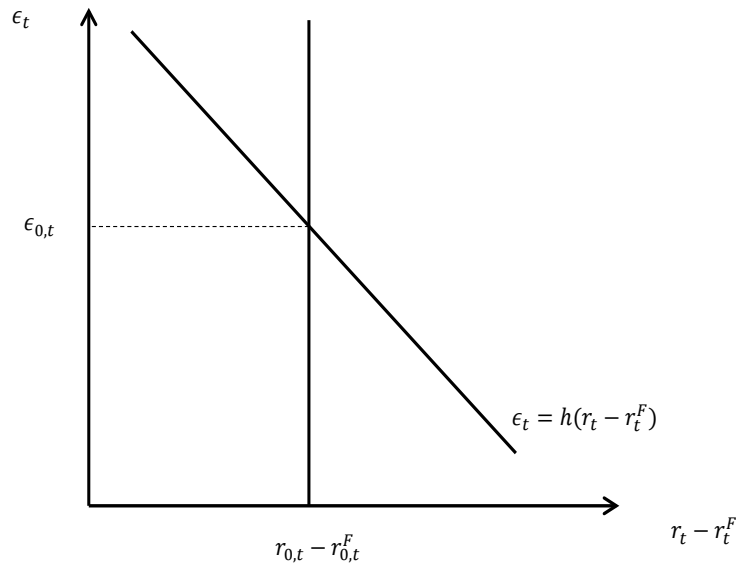

Once the real exchange rate is known, the nominal exchange rate can be determined from (22.34), given ϵ_t and P_t and the exogenous value of the foreign price level, P_t^F .

22.3 Effects of Shocks in the Open Economy Model

In this section, we consider the effects of changes in an exogenous variable on the equilibrium values of the open economy version of the neoclassical model. We will do so graphically. We will start in the $IS - Y^s$ equilibrium and determine the effects of a shock on r_t and Y_t , and from that we can infer the effects on the expenditure components of output as well. We will then determine the effect on the price level. Then we will determine the effect on the real and nominal exchange rates.

In some of the exercises which follow, we will compare the effects of in the open economy to a hypothetical closed economy (which features a comparatively steeper IS curve). What we will find is that r_t will respond less to shocks in the open economy than in the closed economy.

22.3.1 Positive IS Shock

Let us first consider the effects of a positive shock to the IS curve, emanating from a change in one of the exogenous variables common to both the closed and open economy versions of the model. The picture which follows could result from an increase in A_{t+1} or G_t ,

or a reduction in G_{t+1} . For clarity, we will assume it corresponds to an increase in G_t . The effects are depicted in Figure 22.7.

Figure 22.7: Effects of a Positive IS Shock

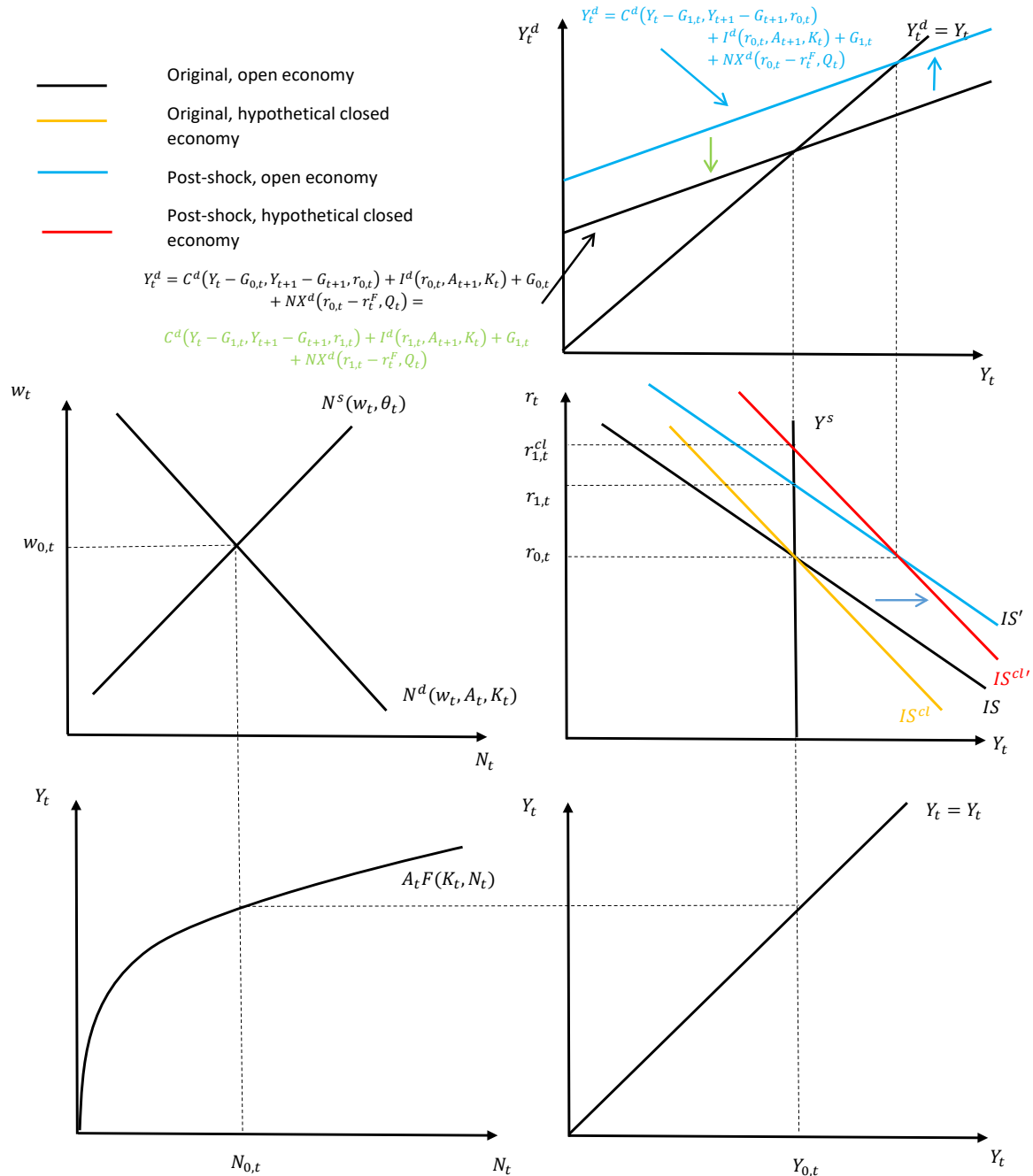

Holding the real interest rate fixed, the increase in G_t causes desired autonomous expenditure to increase for each level of Y_t , causing the expenditure line to shift up (shown in blue). This in turn causes the IS curve to shift out to the right. Since the Y^S curve is vertical, there

is no change in output, only an increase in the real interest rate. The increase in the real interest rate causes the desired expenditure line to shift back to where it began (depicted by the green arrow in the figure). There is no effect on any labor market variables.

For point of comparison, we also show in Figure 22.7 what would happen in a hypothetical closed economy version of the model. The pre-shock position of the closed economy IS curve is depicted in orange, and we assume this IS curve would cross the Y^s curve at the same point where the open economy IS curve crosses the Y^s curve. As noted above, the closed economy IS curve is steeper than the open economy IS curve. The closed economy IS curve would shift by exactly the same horizontal amount after an increase in G_t as in the open economy (depicted with the red IS curve). But because the closed economy IS curve is steeper, the resulting increase in the real interest rate would be larger than in the open economy. In other words, in the open economy version of the model, the real interest rate increases by less than it would after an increase in G_t (or an increase in A_{t+1} or a decrease in G_{t+1}) in a closed economy. Since r_t increases but r_t^F is unchanged, $r_t - r_t^F$ increases, which means that net exports decline. C_t and I_t must both go down via similar arguments to earlier. However, they will fall by *less* than they would in the closed economy – r_t rises by less here, so $C_t + I_t$ falls by less. Total spending is still crowded out one-for-one, but because NX_t also declines, $C_t + I_t$ need not decline by the fall amount of the increase in G_t .

We can next determine the effect of the increase in G_t on the price level. Since r_t is higher but there is no change in Y_t , the demand for money decreases. This pivots the money demand curve inward. Along a stable money supply curve, this necessitates an increase in P_t . This is shown in Figure 22.8.

Figure 22.8: Effect of Positive IS Shock on the Price Level

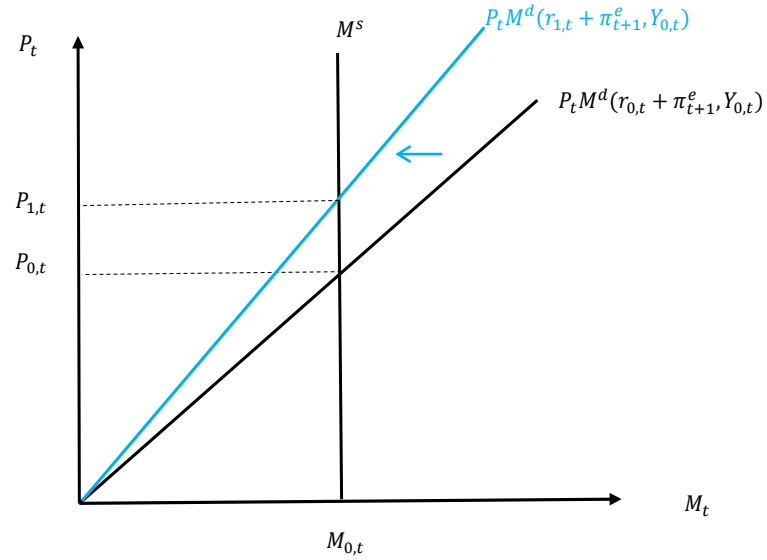

Finally, let us turn to the effect on the real exchange rate. The real exchange rate is a decreasing function of the real interest rate differential. Since $r_t - r_t^F$ increases, ε_t must decrease. This decrease in the real exchange rate represents a real appreciation of the home country goods, which is what drives net exports down. This effect is shown in Figure 22.9 below.

Figure 22.9: Effects of Positive IS Shock on the Real Exchange Rate

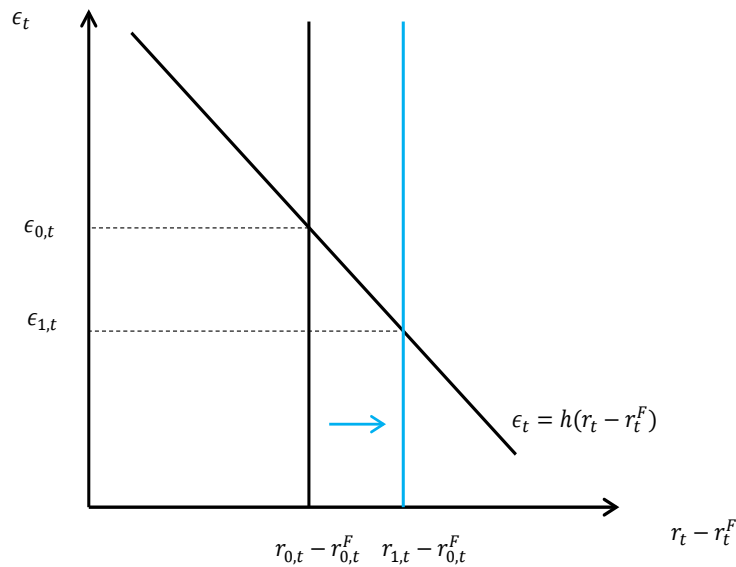

The nominal exchange rate can be written $e_t = \varepsilon_t \frac{P_t}{P_t^F}$. Since ε_t declines but P_t increases,

we cannot say for sure what happens to the nominal exchange rate after the increase in G_t .

22.3.2 Increase in A_t

Now let us consider the effects of an increase in A_t . These are depicted in Figure [22.10](#). For point of comparison, we also examine how the equilibrium would look in the corresponding closed economy version of the model.

Figure 22.10: Effects of an Increase in A_t

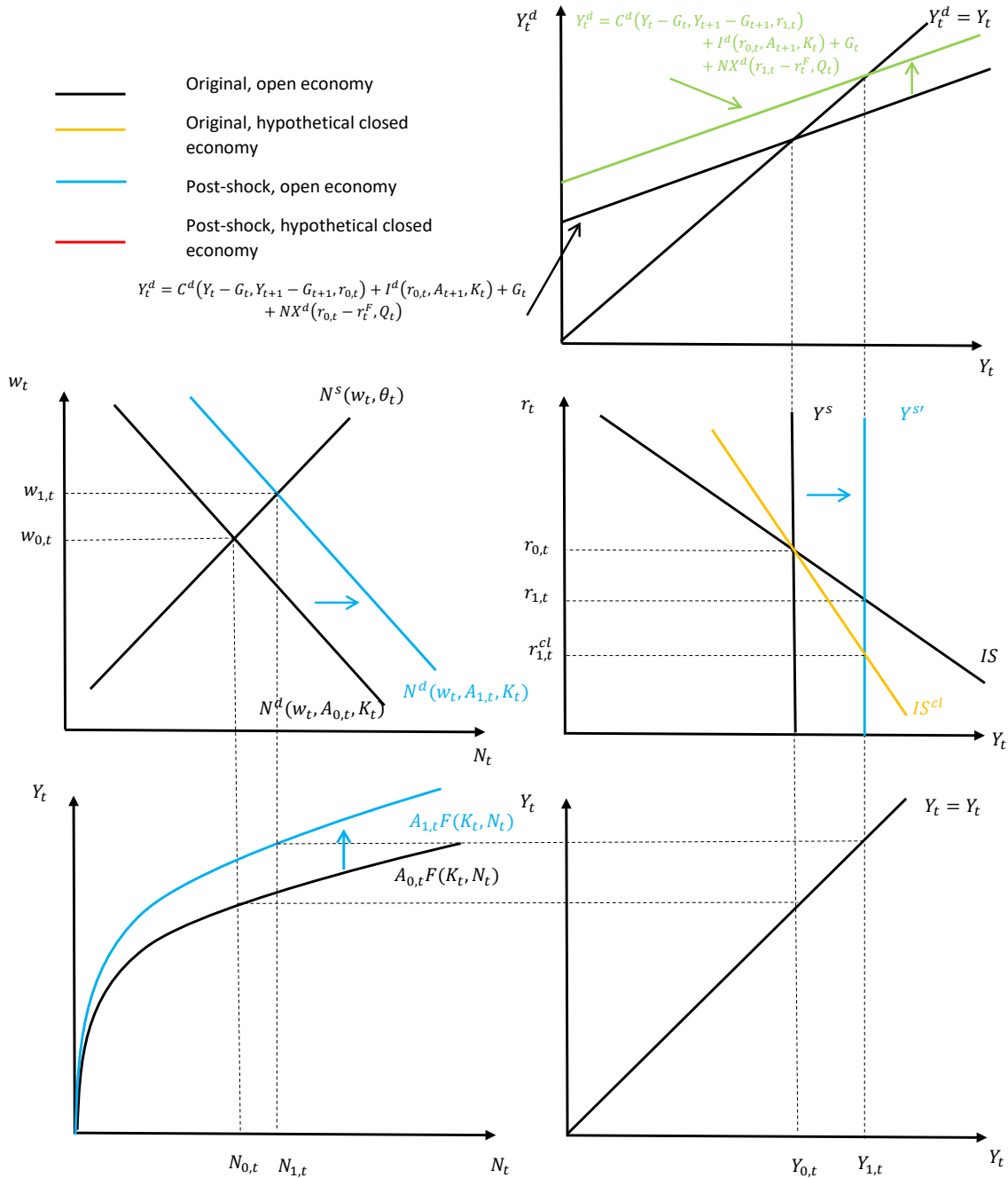

The increase in A_t causes the labor demand curve to shift to the right. This triggers an increase in the real wage and an increase in labor input. The production function also shifts up, since the economy can produce more output for any given amount of labor input. Together, this implies that the vertical Y^s curve shifts to the right. This results in an increase in Y_t and a reduction in r_t . The reduction in r_t triggers an increase in each of the

three endogenous expenditure categories (consumption, investment, and net exports) so that expenditure equals production. This means that C_t , I_t , and NX_t all increase.

If the economy were closed, the IS curve would be steeper. This is depicted in Figure 22.10 with an orange IS curve. With the IS curve steeper, the real interest rate would fall more. Hence, as in the case of an IS shock, the real interest rate reacts less to an exogenous shock than it would in a closed economy. This means that C_t and I_t will increase by less in the open economy than in the closed. The change in Y_t (and also w_t and N_t) is identical to what it would be in a closed economy. The decrease in r_t causes NX_t to rise – since NX_t rises and there is the same increase in Y_t as in a closed economy, $C_t + I_t$ increases by less than in a closed economy.

Since r_t is lower and Y_t higher, there is more demand for money. The money demand curve pivots to the right, as shown in Figure 22.11, which causes a reduction in the price level.

Figure 22.11: Effect of Increase in A_t on the Price Level

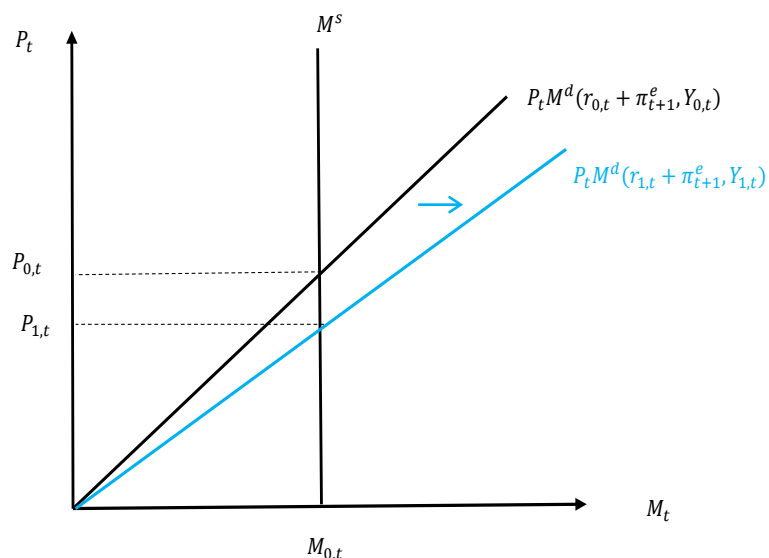

Since r_t is lower, $r_t - r_t^F$ is lower. As shown in Figure 22.12, this means that ε_t increases. This represents a real depreciation of the home good, which is necessary for net exports to rise.

Figure 22.12: Effects of Increase in A_t Shock on the Real Exchange Rate

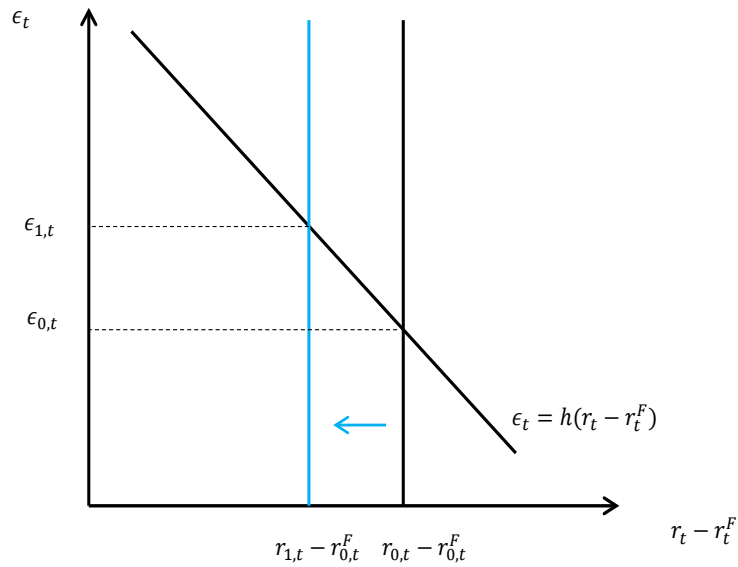

Since the nominal exchange rate is $e_t = \varepsilon_t \frac{P_t}{P_t^F}$, we cannot determine with certainty how e_t changes. ε_t increasing would tend to make e_t increase, but P_t falling would have the opposite effect.

22.3.3 Increase in Q_t

Next, consider the effects of an increase in Q_t . Q_t could represent many things, such as costs of trade, tariffs, foreign tastes for home goods, or foreign incomes. We have normalized things such that an increase in Q_t results in an increase in desired net exports. Hence, for a given real interest rate, when Q_t increases net exports increase. This results in an increase in autonomous desired expenditure, resulting in an outward shift of the IS curve. This is depicted in Figure 22.13.

Figure 22.13: Effects of Increase in Q_t

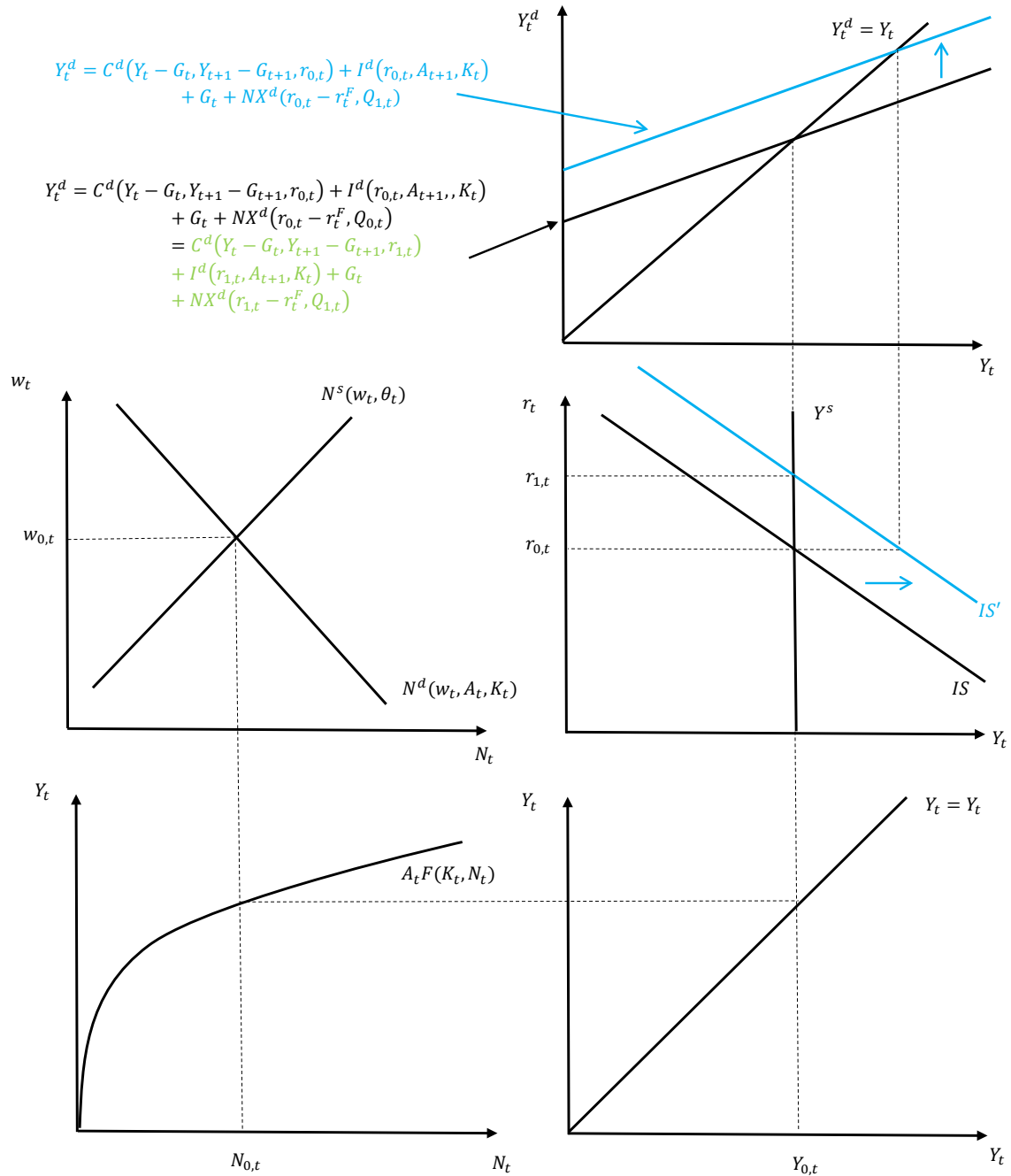

Since the Y^s curve is vertical, there is no effect of the outward shift of the IS curve on output. The real interest rate rises. The higher real interest rate, coupled with no change in Y_t , means that consumption and investment are both lower. Since consumption and investment are both lower, net exports must be higher. Since the real interest rate is lower but there is no change in output, the money demand curve pivots in. This results in an

increase in the price level, which is shown in Figure 22.14.

Figure 22.14: Effect of Increase in Q_t on the Price Level

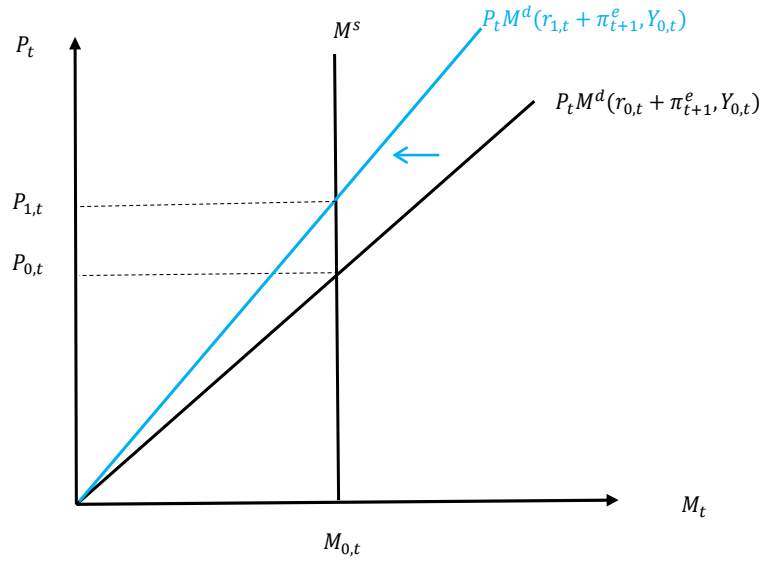

Since r_t is higher but r_t^F is unaffected, the real exchange rate must decline (i.e. appreciate). This is shown graphically in Figure 22.15. Note that net exports increase even though the $r_t - r_t^f$ increases (and hence the real exchange rate appreciates), because of the direct effect of higher Q_t . Since ε_t falls but P_t rises, it is not possible to determine how e_t reacts to an increase in Q_t .

Figure 22.15: Effects of Increase in Q_t Shock on the Real Exchange Rate

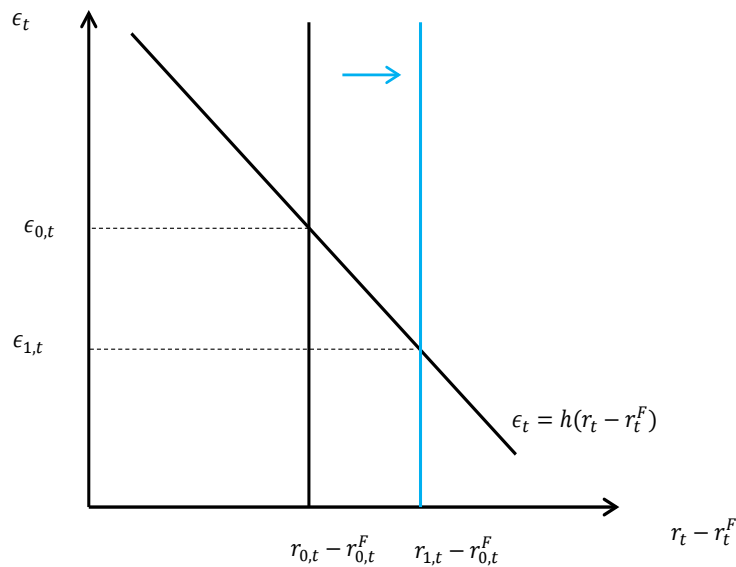

22.3.4 Increase in M_t

Now, let us turn to how changes in nominal exogenous variables impact the equilibrium. As in the closed economy model, the classical dichotomy holds and money is neutral. An increase in M_t has no impact on any real endogenous variables. The increase in M_t results in a higher price level, shown below in Figure 22.16.

Figure 22.16: Effect of Increase in M_t

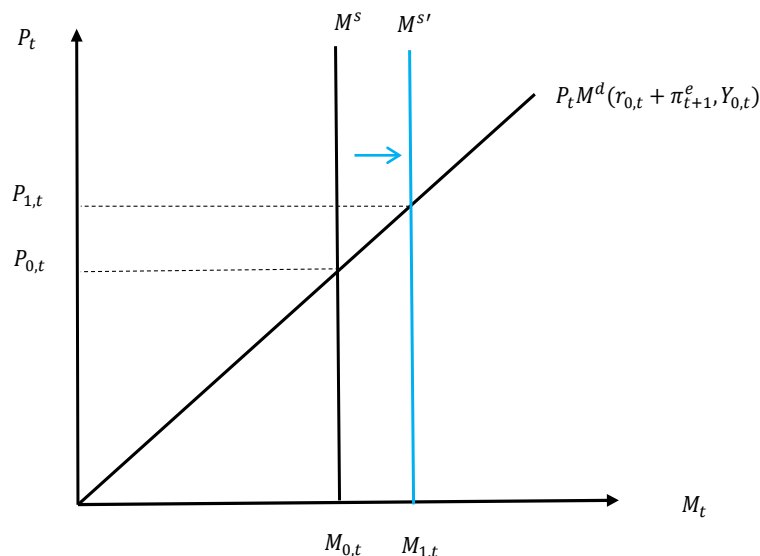

Since P_t is higher but ε_t is unchanged, the nominal exchange rate, e_t , must increase after an increase in M_t . This means that the nominal exchange rate depreciates after an increase in the money supply.

22.3.5 Increase in P_t^F

An increase in P_t^F , the foreign price level, has no effects on any real variables. The only effect is to result in a reduction in the nominal exchange rate, e_t . In other words, if the foreign price level increases, then the home currency appreciates in nominal terms (with no effect on the real exchange rate).

22.3.6 Summary of Qualitative Effects

Table 22.1 below summarizes the qualitative effects of changes in exogenous variables on the endogenous variables of the open economy neoclassical model.

Table 22.1: Qualitative Effects of Exogenous Shocks on Endogenous Variables in Open Economy Model

Variable	$\uparrow A_t$	Exogenous Shock			
		Positive IS Shock	$\uparrow Q_t$	$\uparrow M_t$	$\uparrow P_t^F$
Y_t	+	0	0	0	0
w_t	+	0	0	0	0
r_t	-	+	+	0	0
NX_t	+	-	+	0	0
P_t	-	+	+	+	0
ε_t	+	-	-	0	0
e_t	?	?	?	+	-

22.4 Summary

- Up until this chapter, everything produced in a country was consumed in the same country. In reality, citizens across countries exchange goods and services. Net exports is the difference between exports and imports.
- The real exchange rate is the rate at which a home good is exchanged for a foreign good. The nominal exchange rate is the rate at which one unit of foreign currency trades for domestic currency. The nominal exchange rate times the relative price of foreign to domestic goods equals the real exchange rate.
- If the real exchange rate is high, home goods are relatively cheaper than foreign goods and vice versa. Therefore, net exports is increasing in the real exchange rate. The real exchange rate is a decreasing function of the difference between home and foreign real interest rates. The idea is that if the real interest rate at home exceeds the real interest rate in foreign, the real return to saving is higher at home which drives up demand for home goods relative to foreign goods which puts downwards pressure on the real exchange rate.
- The IS curve is flatter in the open economy compared to the domestic economy. In the limit, if the domestic economy is a small open economy, the IS curve is perfectly horizontal. That means the domestic real interest rate is never different than the foreign real interest rate. Because the IS curve is flatter, the real interest rate is less sensitive to changes in the domestic economy.

Key Terms

1. Real exchange rate

2. Nominal exchange rate
3. Small open economy

Questions for Review

1. Explain why net exports is an increasing function of the real exchange rate.
2. Explain why the real exchange rate is a decreasing function of the difference between home and foreign real interest rates.
3. Suppose the real exchange rate is 10 and the nominal exchange rate is 4. What is the ratio of the foreign price level to the home price level?
4. Describe how the real exchange rate in the small open economy responds to a change in the real interest rate differential.
5. How does the IS curve in the open economy compare to the IS curve in the closed economy?
6. How are net exports affected after a positive IS shock?
7. Suppose trade restrictions are placed on foreign imports. What exogenous variable would proxy for this effect?

Exercises

1. Graphically analyze the effects of an increase in θ_t . Clearly describe how each endogenous variable is affected.
2. Graphically analyze the effects of an increase in r_t^f . Clearly describe how each endogenous variable is affected.
3. Small open economies are often developing economies. In this problem we investigate productivity shocks in developed versus developing economies.
 - (a) Derive the effects on all the endogenous variables of a decrease in A_t in a developed economy.
 - (b) Derive the effects on all the endogenous variables of a decrease in A_t in a developing economy.
 - (c) In the data, developing economies are more volatile than developed economies. Is the Neoclassical model consistent with this?
4. Derive the effects on all the endogenous variables of a permanent increase in productivity (i.e. a simultaneous increase in A_t and A_{t+1} by the same amount) in the open economy model.

5. Suppose that you have three different economies: a closed economy, an open economy, and a small open economy. Graphically analyze the consequences of an increase in G_t on the endogenous variables of each model. Compare the effects of the increase in G_t on r_t , C_t , and I_t across the three different models. Comment on the differences.

Part V

The Short Run

We studied the neoclassical model in Part IV. In this model, money is neutral and demand shocks do not affect output. The equilibrium is efficient, and so there is no justification for activists policies meant to stabilize the business cycle.

In Part V, we study what we call the “short run.” We think of the short run as measuring units of time ranging from months up to several years. While Robert Lucas once famously said that “Once one begins to think about growth it is difficult to think about anything else,” John Maynard Keynes once also said “In the long run we are all dead.”

Simple personal experience (i.e. people certainly seem to think that what central banks do has an effect on the real economy) as well as econometric evidence suggests that money is not neutral, at least over short time horizons. Furthermore, there is ample reason to be skeptical that fluctuations in output are driven primarily by quarter-to-quarter changes in productivity, and that the resulting changes in output and labor input are efficient. For this reason, we seek a framework that differs as little as possible from the neoclassical model but which allows us to address questions related to the non-neutrality of money, the role of demand shocks, and activist economic policies.

Our framework for doing so is the New Keynesian model. We call this the “New” Keynesian model, as opposed to simply the Keynesian model, because the “backbone” of the model is the neoclassical model, the underpinning of which is intertemporal optimization and market-clearing. New Keynesian models were developed in the 1980s largely in response to the development of real business cycle models, and are now the standard framework for thinking about business cycles and economic policy at central banks and other policy institutions around the world. While the graphs and policy implications of New Keynesian models are in many ways similar to their “old” Keynesian predecessor, they are built up from firm microfoundations so as to be immune from some of the critiques levied against older Keynesian models which we discussed in Chapter 3.

The New Keynesian model differs from the neoclassical model in its treatment of the supply side of the economy. The differential treatment of supply means that shocks to demand can influence output and other real variables in the short run. In Chapter 23, we discuss the graphical building blocks of the New Keynesian model, which are the IS, LM, and AD curves. These curves summarize the demand side of the model. Since there is no difference between the demand sides of the New Keynesian and neoclassical models, the IS, LM, and AD curves can also be used to graphically summarize the neoclassical model.

New Keynesian models differ from neoclassical models in that they assume that the economy is subject to nominal rigidities in the short run. By nominal rigidity, we mean that either prices or wages are “sticky” in the short run, by which we mean that prices or wages are unable to instantaneously adjust in response to exogenous shocks. Direct empirical

evidence in support of nominal stickiness is available in [Bils and Klenow \(2004\)](#) for prices and in [Barattieri, Basu, and Gottschalk \(2014\)](#) for wages. In Chapter 24, we discuss how to incorporate sticky prices into an otherwise standard neoclassical model. Appendix D discusses the supply side of the economy when wages are sticky. We consider two models of price stickiness. In the first, what we call the “simply sticky price model,” the aggregate price level is fixed in the short run. The aggregate supply curve (or AS curve) is a plot of the aggregate price level against output. In the neoclassical model, this curve would be vertical, and hence equilibrium output is completely supply-determined. In the simple sticky price model, in contrast, the AS curve is horizontal, which means that output is completely demand determined in the short run. We consider a hybrid case, which we call the “partial sticky price model,” in which the AS curve is upward-sloping but non-vertical. It is important to emphasize that the equations underlying the sticky price model are very similar to those in the neoclassical model. When moving from the neoclassical to the New Keynesian model, we simply replace the labor demand curve with the AS curve.

In Chapter 25, we study how the endogenous variables of the model react to changes in exogenous variables. There we include a comparison of the effects of changes in exogenous variables on endogenous variables in the neoclassical and New Keynesian models. A key take-away is that demand shocks affect output more, and supply shocks affect output less, in the New Keynesian model than in the neoclassical model. In Chapter 26, we study how the economy transitions from the short run to the medium run. In the New Keynesian model, if the economy finds itself with an equilibrium level of output that is higher (lower) than what would obtain in the neoclassical model, there is pressure on the price level to increase. This adjustment of the price level causes the AS curve to shift, and eventually ensures that the equilibrium of the New Keynesian model coincides with the equilibrium of the neoclassical model. Neoclassical and New Keynesian economists primarily differ in terms of how long this adjustment takes. New Keynesians think that this adjustment could take a long time, while neoclassical economists believe that it happens quickly.

We discuss optimal policy in Chapter 27. As we show in Chapter 15 and discuss in 21, the equilibrium of the neoclassical model is efficient in the sense of being optimal from the perspective of a benevolent social planner. To maximize well-being, policy should therefore adjust in such a way as to ensure that the equilibrium of the New Keynesian model coincides with the equilibrium of the neoclassical model. We show that this means that a central bank ought to engage in countercyclical monetary policy (reducing the money supply and increasing interest rates) in response to positive demand shocks, while the central bank ought to engage in accommodative policy conditional on positive supply shocks (by which we mean that the central bank ought to increase the money supply and lower the interest rate in response to a

favorable supply shock). We also discuss how the model provides some justification for the inflation targeting practices of many central banks throughout the world. In addition, we introduce the concept of the natural rate of interest and discuss its implications for policy.

In Chapter 28 we discuss how the zero lower bound (ZLB) on nominal interest rates impacts the Keynesian model. We show that the ZLB means that one can think of the AD curve as being vertical within a region. This accentuates the differences between the New Keynesian and neoclassical models in that IS shocks have even bigger effects on output, and supply shocks even smaller effects on output, in comparison to the neoclassical model. It also renders conventional monetary policy ineffective and the economy is susceptible to getting “stuck” in a spiral of low output and deflation when the ZLB binds. We discuss why the ZLB is undesirable from the perspective of policymakers and how they might enact policies so as to avoid it in the first place. Chapter 29 considers an open economy version of the New Keynesian model.

Chapter 23

The New Keynesian Demand Side: IS-LM-AD

While New Keynesian models emphasize the role of demand shocks in driving economic fluctuations, the demand side of the model is *identical* to the neoclassical model. The models differ in terms of the supply-side. Effectively, in the New Keynesian model, the supply-side differs relative to the neoclassical model in such a way as to permit demand shocks to influence the level of output.

The equations underlying the demand side of the economy are as follows:

$$C_t = C^d(Y_t - G_t, Y_{t+1} - G_{t+1}, r_t) \quad (23.1)$$

$$I_t = I^d(r_t, A_{t+1}, K_t) \quad (23.2)$$

$$Y_t = C_t + I_t + G_t \quad (23.3)$$

$$M_t = P_t M^d(r_t + \pi_{t+1}^e, Y_t) \quad (23.4)$$

$$r_t = i_t - \pi_{t+1}^e \quad (23.5)$$

Expression (23.1) is the consumption function and (23.2) is the investment demand function. The aggregate resource constraint is given by (23.3). These three equations can be summarized by the IS curve, which plots the combinations of (r_t, Y_t) for which these three equations hold. We summarized the demand side in the neoclassical model with this curve. In the New Keynesian model, which will feature monetary non-neutrality, we also want to incorporate equilibrium conditions from the nominal side of the economy. (23.4) is the money demand expression and (23.5) is the Fisher relationship. We will introduce a new curve, called the LM curve, which plots the (r_t, Y_t) combinations for which these two expressions hold. A new curve, called the AD curve (which stands for aggregate demand) will graph the combinations of P_t and Y_t for which all five of these equations hold, which means that we are on both the IS and LM curves. In this chapter we graphically derive the AD curve and discuss changes in exogenous variables which cause it to shift.

23.1 The LM Curve

The LM curve stands for “liquidity = money” and plots combinations of r_t and Y_t for which the money market is in equilibrium, taking the price level and money supply as given. In particular, it plots the combinations of (r_t, Y_t) for which (23.4)-(23.5) hold.

To graphically derive the LM curve, it is convenient to work with a specification in which the demand for money is plotted as a decreasing function of r_t (rather than as an increasing function of P_t). This is the same as the alternative plot shown in the right panel of 17.8 from Chapter 17. It is exactly the same underlying money demand function as shown in (23.4)-(23.5), just with a different variable on the vertical axis.

A graphical derivation of the LM curve is shown in Figure 23.1 below. Draw two axes side by side with r_t on the vertical axes. M_t is on the horizontal axis in the left plot, while Y_t is on the horizontal axis on the righthand plot. In the left plot we show money demand, which is downward-sloping in r_t taking Y_t , π_{t+1}^e , and P_t as given (hence we denote the values of these variables with 0 subscripts). The money demand curve would shift right if Y_t were bigger, if P_t were bigger, or if π_{t+1}^e were smaller. The money supply curve is a vertical line at some exogenous value of the money supply, $M_{0,t}$.

For a given Y_t , call it $Y_{0,t}$, as well as given values of $M_{0,t}$, $P_{0,t}$, and $\pi_{0,t+1}^e$, determine the position of the money demand curve and find the real interest rate, $r_{0,t}$, where it intersects money supply. This is a (r_t, Y_t) pair consistent with money demand equaling supply taking M_t , P_t , and π_{t+1}^e as given. Next, suppose that income is bigger, with $Y_{1,t} > Y_{0,t}$. A higher value of income causes the money demand curve to shift to the right. This results in a higher value of the real interest rate, $r_{1,t}$, consistent with money demand equaling supply. This is a new (r_t, Y_t) pair consistent with the money market being in equilibrium. Connecting these pairs in the right hand plot, we get an upward-sloping curve. This is the LM curve.

Figure 23.1: The LM Curve: Derivation

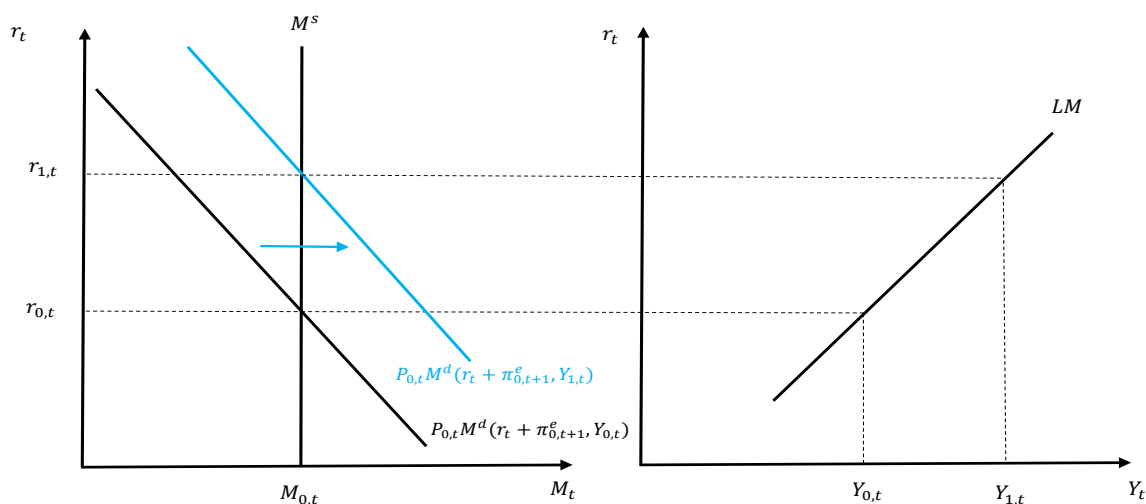

The LM curve is drawn for given values of M_t , P_t , and π_{t+1}^e . Changes in any of these variables will cause either the money demand or supply curves to shift, resulting in a shift of the LM curve. Consider first an increase in M_t from $M_{0,t}$ to $M_{1,t}$. As shown in Figure 23.2, an increase the money supply results in the equilibrium real interest rate falling, from $r_{0,t}$ to $r_{1,t}$, for a given level of income, $Y_{0,t}$. This means that all (r_t, Y_t) pairs consistent with the money market being in equilibrium lie below the original LM curve after an increase in M_t . Put differently, an increase in M_t causes the LM curve to shift *down*, equivalently to the *right*.

Figure 23.2: The LM Curve: Increase in M_t

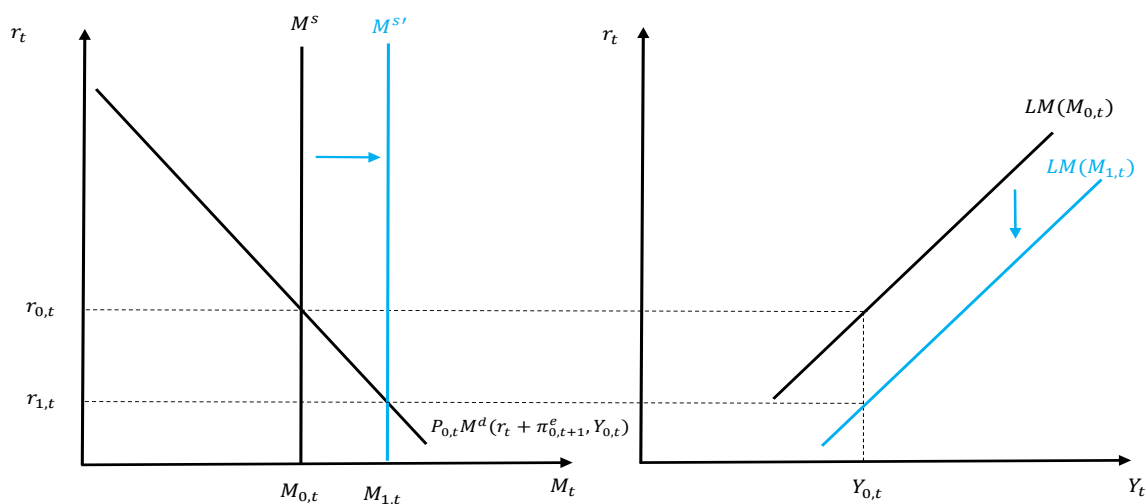

Next, consider an increase in the price level, from $P_{0,t}$ to $P_{1,t}$. For a given value of income,

this causes the money demand curve to shift to the right – if it costs more money to purchase goods, then the household demands more money, other factors held constant. The money demand curve shifting to the right means that the real interest rate consistent with the money market being in equilibrium rises for a given value of income. In other words, the (r_t, Y_t) pairs consistent with the money market being in equilibrium with a higher price level lie above those with a lower price level. Put slightly differently, a higher P_t causes the LM curve to shift up (equivalently, in to the left). This is shown in Figure 23.3 below.

Figure 23.3: The LM Curve: Increase in P_t

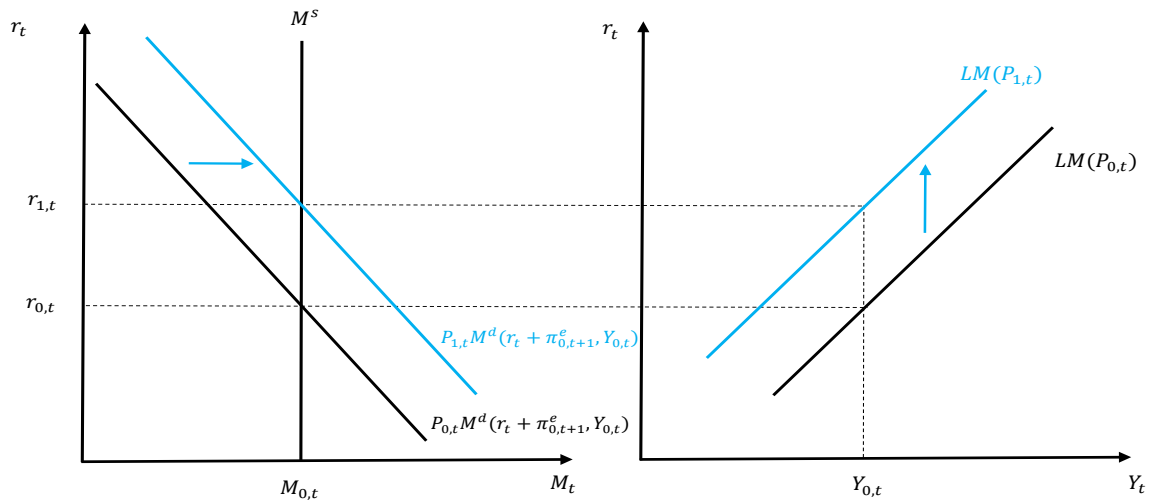

A simple rule of thumb is the following. The position of the LM curve depends on the level of *real money balances*, M_t/P_t . If real money balances increases (either because of an increase in M_t or a decrease in P_t), the LM curve shifts down (equivalently to the right). If real money balances decreases (either because of a decrease in M_t or an increase in P_t), the LM curve shifts up (equivalently in to the left).

The final determinate of the position of the LM curve is the level of expected inflation. Expected inflation matters for money demand because, given a real interest rate, higher expected inflation translates into a higher nominal interest rate. A higher nominal interest rate means that the opportunity cost of holding money (relative to interest-bearing assets like bonds) is higher, resulting in lower demand for money, other factors held constant. Figure 23.4 shows how the LM curve shifts when π_{t+1}^e increases from $\pi_{0,t+1}^e$ to $\pi_{1,t+1}^e$, the demand curve for money shifts in to the left. This results in the real interest rate consistent with the money market clearing falling. A lower real interest rate for a given level of income means that the entire LM curve shifts down (equivalently to the right) when expected inflation increases.

Figure 23.4: The LM Curve: Increase in π_{t+1}^e

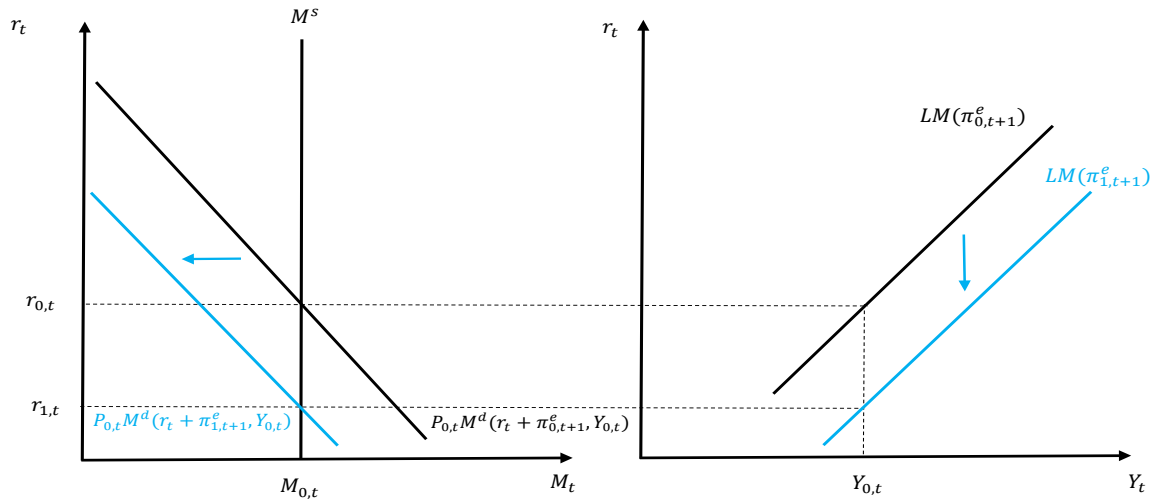

Table 23.1 below summarizes the qualitative direction of how the LM curve shifts when one of the variables which the LM curves holds fixed changes.

Table 23.1: LM Curve Shifts

Change in Variable	Direction of Shift of LM
$\uparrow M_t$	Down (Right)
$\uparrow P_t$	Up (Left)
$\uparrow \pi_{t+1}^e$	Down (Right)

23.2 The IS Curve

The IS curve plots the combinations of (r_t, Y_t) for which (23.1)-(23.3) hold. It is the same IS curve which we encountered in the neoclassical model. The graphical derivation is repeated below in Figure 23.5 for completeness.

Figure 23.5: The IS Curve: Derivation

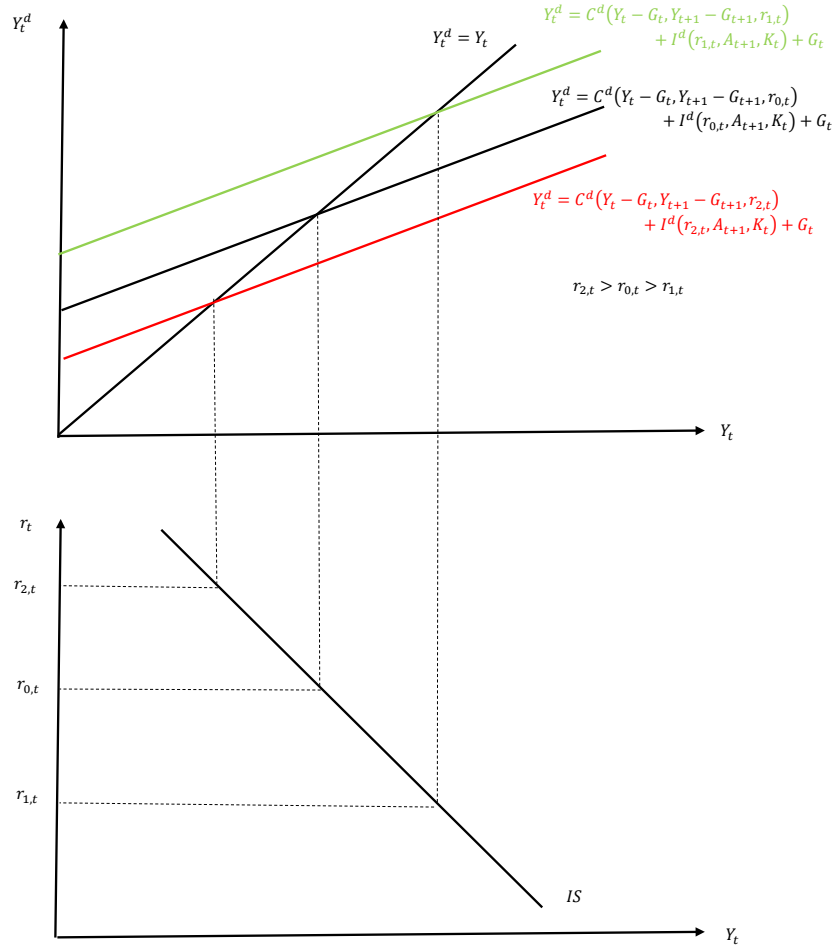

The IS curve will shift if any variable changes which affects the level of autonomous expenditure (i.e. the vertical axis intercept of the expenditure line). The IS curve will shift to the right if A_{t+1} or G_t increase. It will shift left if G_{t+1} increases. It would shift to the right if K_t were to decrease, though we will not consider such a shift here. Table 23.2 summarizes how the IS curve shifts in response to changes in different variables.

Table 23.2: IS Curve Shifts

Change in Variable	Direction of Shift of IS
$\uparrow A_{t+1}$	Right
$\uparrow G_t$	Right
$\uparrow G_{t+1}$	Left

23.3 The AD Curve

The AD curve plots the combinations of (P_t, Y_t) for which equation (23.1)-(23.5) all simultaneously hold. In graphical terms, it plots the combinations of (P_t, Y_t) where the economy is on both the IS and the LM curves.

The AD curve can be derived graphically as follows. Draw two graphs with the same horizontal axes on top of one another – the IS-LM curves in the upper graph, and a graph with P_t on the vertical axis and Y_t on the horizontal axis in the lower graph. This is shown in Figure 23.6. Start with a particular price level, $P_{0,t}$. Holding the other exogenous variables fixed, this determines a position of the LM curve. Find the level of output where the IS and LM curves intersect for this value of $P_{0,t}$. This gives a $(P_{0,t}, Y_{0,t})$ pair. Next, consider a lower value of the price level, $P_{1,t}$. A lower price level causes the LM curve to shift to the right (equivalently down), so that it intersects the IS curve at higher value of output, $Y_{1,t}$. This gives a pair $(P_{1,t}, Y_{1,t})$ that is to the southeast of the original pair. Consider next a higher price level, $P_{2,t} > P_{0,t}$. This causes the LM curve to shift in (equivalently up), resulting in a lower level of output for which the economy is on both the IS and LM curves. This gives a pair $(P_{2,t}, Y_{2,t})$ which is to the northwest of the original price level, output combination. Connecting these pairs in the graph with P_t on the vertical axis and Y_t on the horizontal axis yields a downward-sloping curve which we will call the AD curve.

Figure 23.6: The AD Curve: Derivation

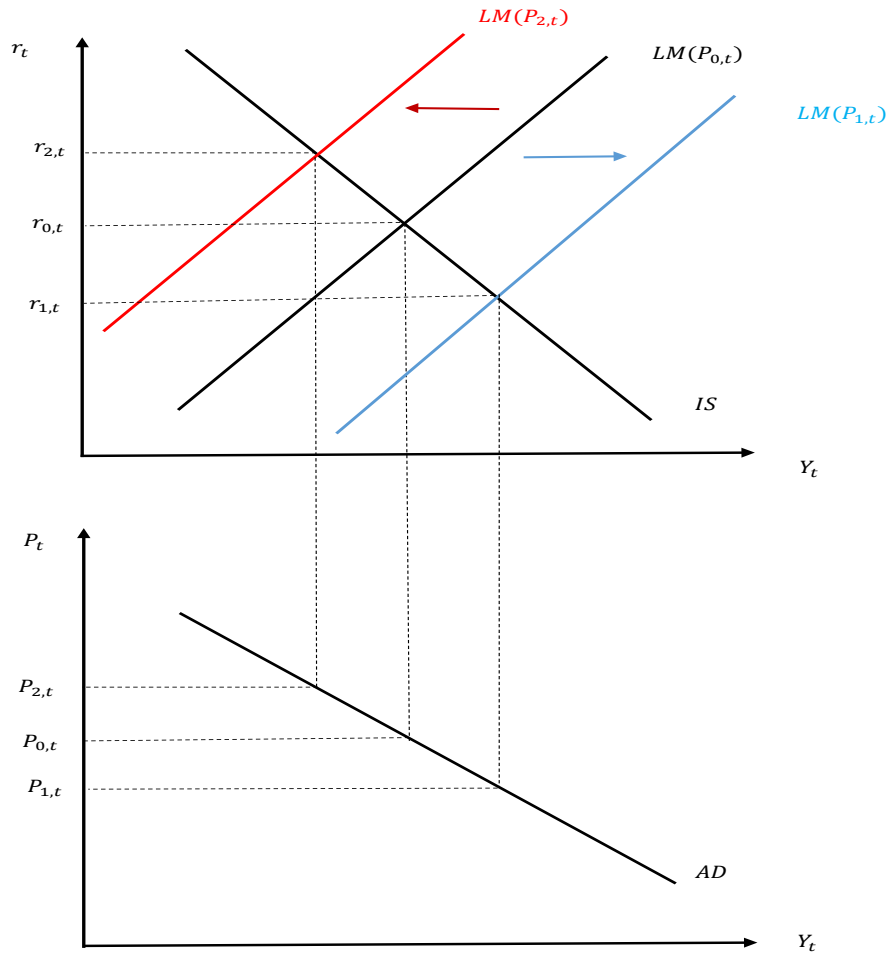

The AD curve is drawn holding fixed all exogenous variables which impact the positions of the IS or LM curves. Changes in exogenous variables which cause either the LM or the IS curve to shift will cause the AD curve to shift. Note that a change in P_t causes the LM curve to shift, but not the AD curve to shift, because this is a movement along the AD curve. Let us now analyze how changes in these different exogenous variables will affect the position of the AD curve.

Consider first an increase in M_t . An increase in M_t causes the LM curve to shift to the right. Holding the price level fixed, this results in a higher value of output where the IS and LM curves intersect. Call this value of output $Y_{1,t}$. This means that the AD curve must now pass through the point $(P_{0,t}, Y_{1,t})$, which lies to the right of the original point $(P_{0,t}, Y_{0,t})$. In other words, an increase in M_t causes the AD curve to shift to the right. The AD curve would also shift to the right if there were an increase in π_{t+1}^e , which also causes the LM curve to shift to the right.

Figure 23.7: Shift of the AD Curve: Increase in M_t

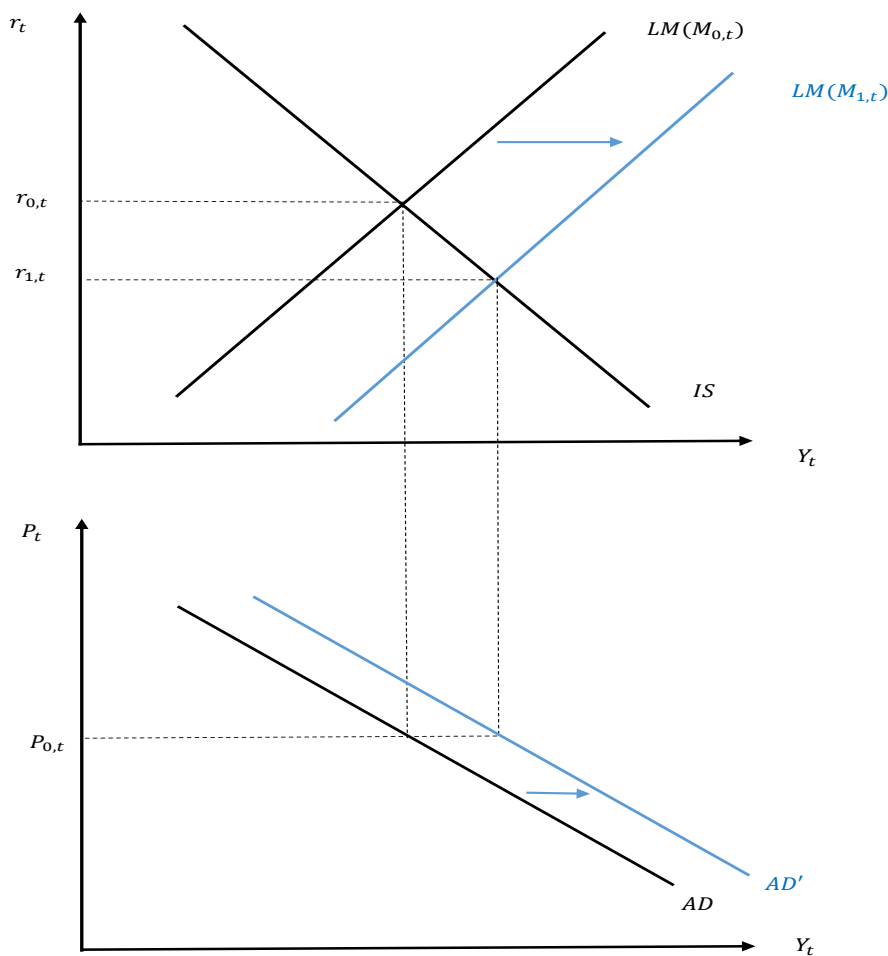

Next, consider a change in an exogenous variable which causes the IS curve to shift. This includes changes in A_{t+1} , G_t , and G_{t+1} . Suppose that one of these exogenous variables changes in such a way that the IS curve shifts out to the right (i.e. there is an increase in A_{t+1} or G_t , or a decrease in G_{t+1}). The IS curve shifts to the right. For a given price level (i.e. holding fixed the position of the LM curve), the level of output at which the IS and LM curves intersect is higher. This means that the AD curve shifts out horizontally to the right.

Figure 23.8: Shift of the AD Curve: IS Shock

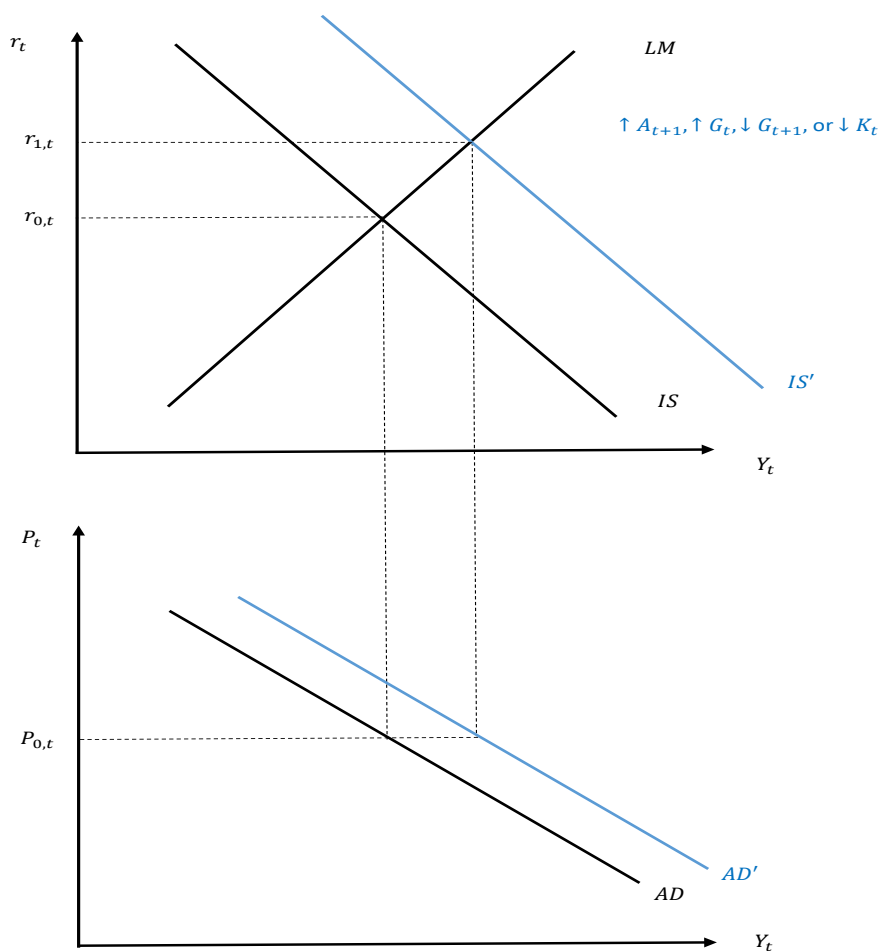

Table 23.3 below shows the qualitative direction in which the AD curve shifts when an exogenous variable changes.

Table 23.3: AD Curve Shifts

Change in Variable	Direction of Shift of AD
$\uparrow M_t$	Right
$\uparrow \pi_{t+1}^e$	Right
$\uparrow A_{t+1}$	Right
$\uparrow G_t$	Right
$\uparrow G_{t+1}$	Left

23.4 Summary

- The demand side in New Keynesian models is identical to the Neoclassical model. Because the New Keynesian model features monetary non-neutrality, we adopt an alternative graphical depiction so as to allow real and nominal variables to be simultaneously determined.
- The LM curve depicts all the (r_t, Y_t) combinations such that the money market is in equilibrium, taking the price level and money supply as given.
- The LM curve shifts to the right after an increase in the money supply and left after an increase in the price level. In general, the LM curve shifts in the same direction as real money balances, $\frac{M_t}{P_t}$, moves.
- The LM curve shifts to the right after an increase in expected inflation.
- The IS curve is derived exactly the same way as in the Neoclassical model.
- The AD curve plots all the (P_t, Y_t) combinations where the IS and LM curves intersect.
- If an exogenous change shifts the IS curve to the right, the AD curve also shifts to the right. If an exogenous change shifts the LM curve to the left, the AD curve also shifts to the left.

Questions for Review

1. In words, define the LM curve.
2. How is the LM curve affected by an increase in expected inflation?
3. In words, define the AD curve.
4. Which exogenous variables cause the AD curve to shift?

Exercises

1. This question explores the shapes of the IS, LM, and AD curves on a deeper level.
 - (a) Suppose the demand side of the economy is characterized by Equations (23.1)-(23.5). Graphically derive the AD curve.
 - (b) Suppose Equation (23.1) is replaced with

$$C_t = C(Y_t - G_t, Y_{t+1} - G_{t+1}).$$

Every other equation remains the same. Derive the new AD curve.

- (c) Does an increase in the money supply shift the AD curve by more in part a or part b?
- (d) Now assume $C_t = C(Y_t - G_t, Y_{t+1} - G_{t+1}, r_t)$ but Equation (23.4) is replaced with

$$M_t = P_t M^d(Y_t).$$

Derive the LM and AD curves.

- (e) Instead assume

$$M_t = P_t M^d(r_t + \pi_{t+1}^e).$$

Derive the LM and AD curves.

- (f) Does an expansion of the IS curve shift the AD curve by more in part d or part e?

2. Suppose that the consumption function is given by:

$$C_t = c_1(Y_t - G_t) + c_2(Y_{t+1} - G_{t+1}) - c_3 r_t$$

Suppose that the investment demand curve is given by:

$$I_t = -b_1 r_t + b_2 A_{t+1} - b_3 K_t$$

Here, c_1 , c_2 , and c_3 are positive parameters, as are b_1 , b_2 , and b_3 . Government spending, G_t , is exogenous.

The money demand curve is given by:

$$M_t = P_t - m_1(r_t + \pi_{t+1}^e) + m_2 Y_t$$

Here, m_1 and m_2 are positive parameters.

- (a) Algebraically derive an expression for the IS curve.
- (b) Algebraically derive an expression for the LM curve.
- (c) Algebraically derive an expression for the AD curve.
- (d) Find an expression for how much the AD curve shifts in response to an increase in G_t (i.e. derive an expression for what would happen to Y_t , holding P_t fixed, when G_t increases). Argue that this must be positive but less than 1.

- (e) Suppose that there is no Ricardian Equivalence and that the household is not forward-looking. In particular, suppose that the consumption function:

$$C_t = c_1 Y_t - c_3 r_t$$

Re-derive the expressions for the IS, LM, and AD curves under this scenario. Is it possible that the AD curve could shift out more than one-for-one with the increase in G_t ? Under what kind of parameter values is this most likely?

Chapter 24

The New Keynesian Supply Side

This chapter discusses the supply side of the New Keynesian model. In doing so, we reference back to the the neoclassical model supply side, which we characterized graphically using the Y^s curve. Here, we characterize the supply side of the economy using the AS curve (which stands for aggregate supply). The AS curve plots the combinations of (P_t, Y_t) consistent with the production function and some notion of equilibrium in the labor market (upon which we will expound in more detail below). We can then use the AD and AS curves together to think about how changes in exogenous variables impact the equilibrium values of the endogenous variables of the model.

The AS curve in the neoclassical model, like the Y^s curve, will be vertical. This means that only supply shocks can impact equilibrium output. One can use either the IS- Y^s curves or the AD-AS curves to think about the effects of changes in exogenous variables in that model. In the New Keynesian model, the AS curve is upward-sloping but not vertical. This permits demand side shocks to have effects on the equilibrium value of output. We focus on price stickiness as means for generating a non-vertical AS curve. We consider two forms of price stickiness in the text – the simple sticky price model, which generates a perfectly horizontal AS curve, and the partial sticky price model, which generates a non-vertical but also potentially non-horizontal AS curve. The partial sticky price model nests the neoclassical and simple sticky price models as special cases. In Appendix D, we also consider a model of nominal wage stickiness as a motivation for a non-vertical AS curve.

24.1 The Neoclassical Model

Although our objective is to move away from the neoclassical model, we begin by discussing how to use the AS curve to summarize the supply side of the neoclassical model. The supply side of the neoclassical model is characterized by the following three equations:

$$N_t = N^s(w_t, \theta_t) \tag{24.1}$$

$$N_t = N^d(w_t, A_t, K_t) \tag{24.2}$$

$$Y_t = A_t F(K_t, N_t) \tag{24.3}$$

(24.1) is the labor supply curve, (24.2) is the labor demand curve, and (24.3) is the production function. The AS curve is defined as the set of (P_t, Y_t) pairs where these three equations all hold. To derive the AS curve graphically, start with a particular value of P_t , call it $P_{0,t}$. Determine the level of Y_t consistent with being on both the labor demand and supply curves as well as the production function. Graphically, this occurs at the N_t consistent with being on both the labor demand and labor supply curves in the upper left quadrant of Figure 24.1. Then take this value of N_t and determine Y_t from the production function, shown in the lower left quadrant. The graph in the lower right quadrant is a 45 degree line which simply reflects Y_t onto the horizontal axis. This gives a value $Y_{0,t}$. Since P_t does not show up in any of the expressions (24.1)-(24.3), considering a different value of the price level will not impact the level of Y_t . Hence, the AS curve is vertical (in a way similar to how the Y^s curve was vertical). This is shown below in Figure 24.1.

Figure 24.1: Derivation of the AS Curve

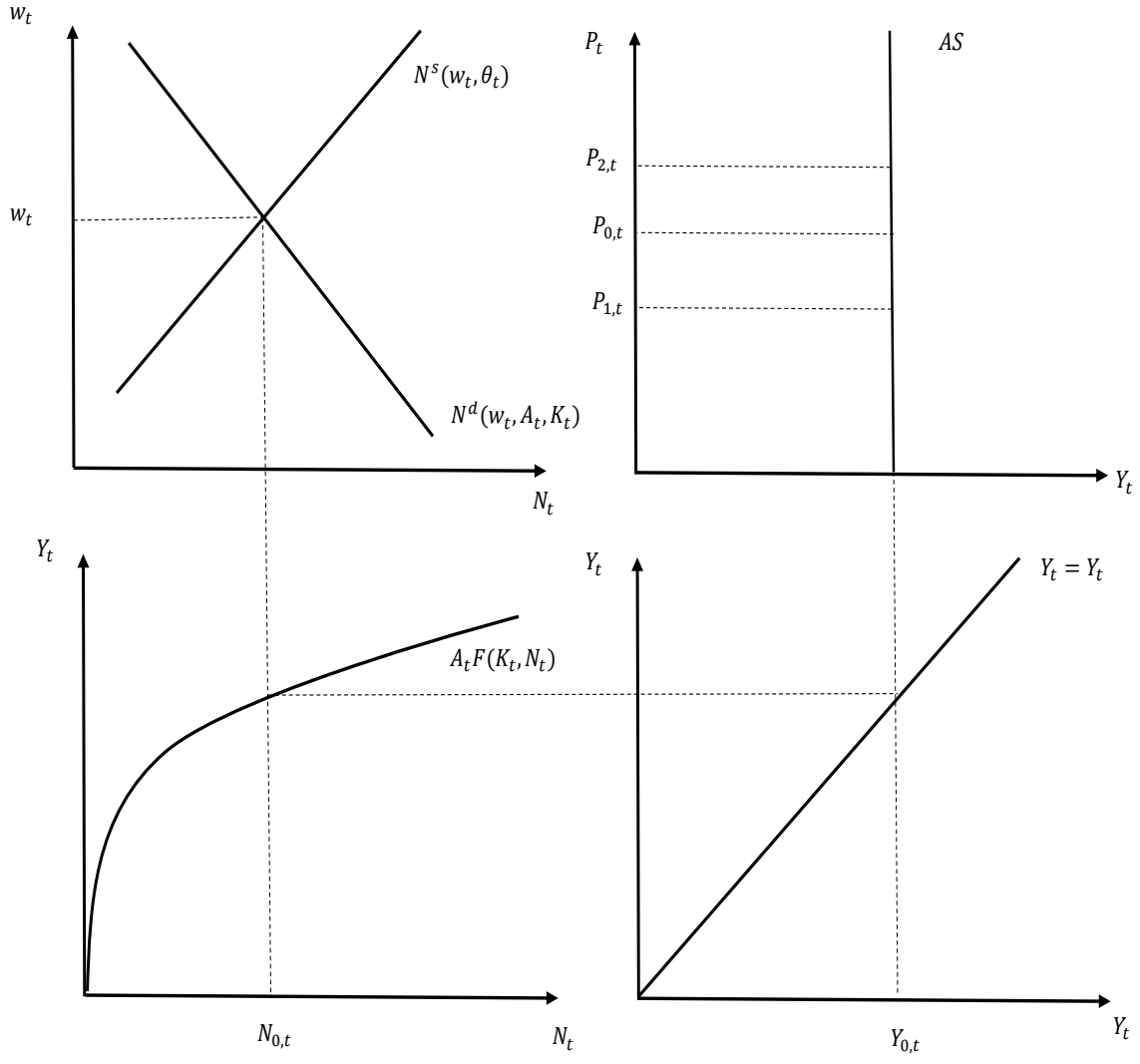

The neoclassical AS curve will shift if an exogenous variable changes which changes the level of Y_t consistent with equations (24.1)-(24.3) holding. The relevant exogenous variables are A_t , θ_t , and K_t . We will not consider a change in K_t here. Consider first an increase in A_t . Graphically, this is shown in Figure 24.2. A change in A_t has two effects. First, it results in the labor demand curve shifting out to the right. This is shown in blue, and results in a higher level of labor input and a higher real wage. Second, a higher A_t shifts the production function up (i.e. the firm produces more output for a given level of N_t). Combining higher N_t with the new production function, the firm will produce more output for any given price level. This new level of output is labeled $Y_{1,t}$. The vertical AS curve shifts out to the right.

Figure 24.2: Shift of the Neoclassical AS Curve: Increase in A_t

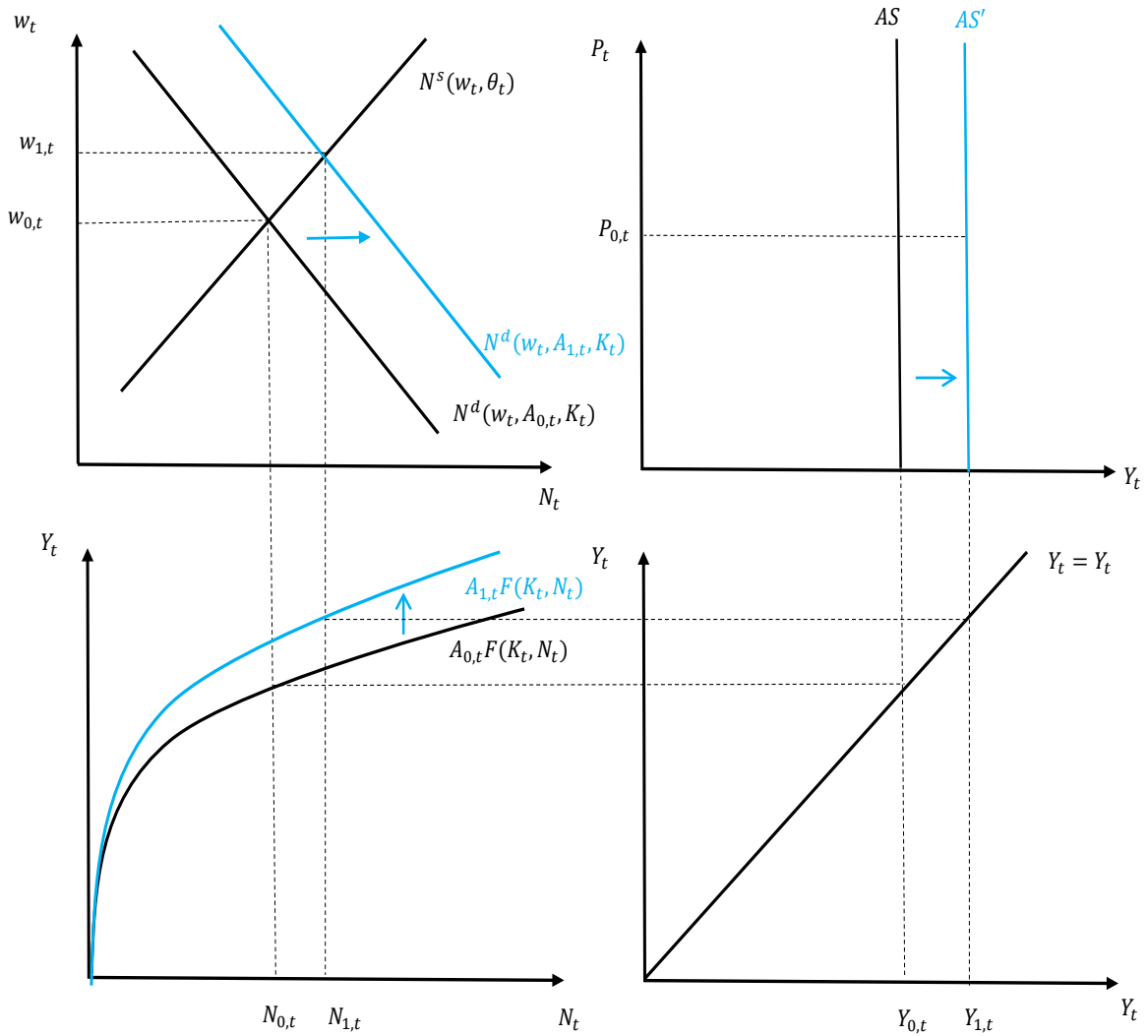

Consider next an increase in θ_t from $\theta_{0,t}$ to $\theta_{1,t}$. An increase in θ_t means that the household dislikes working more, and hence wants to supply less labor for any given real wage. This causes the labor supply curve to shift in to the left, as is shown in blue in Figure 24.3. This results in a higher real wage but lower labor input. There is no shift in the production function. Lower N_t , however, results in a smaller level of output, $Y_{1,t}$. This means that the vertical AS curve shifts in and to the left.

Figure 24.3: Shift of the Neoclassical AS Curve: Increase in θ_t

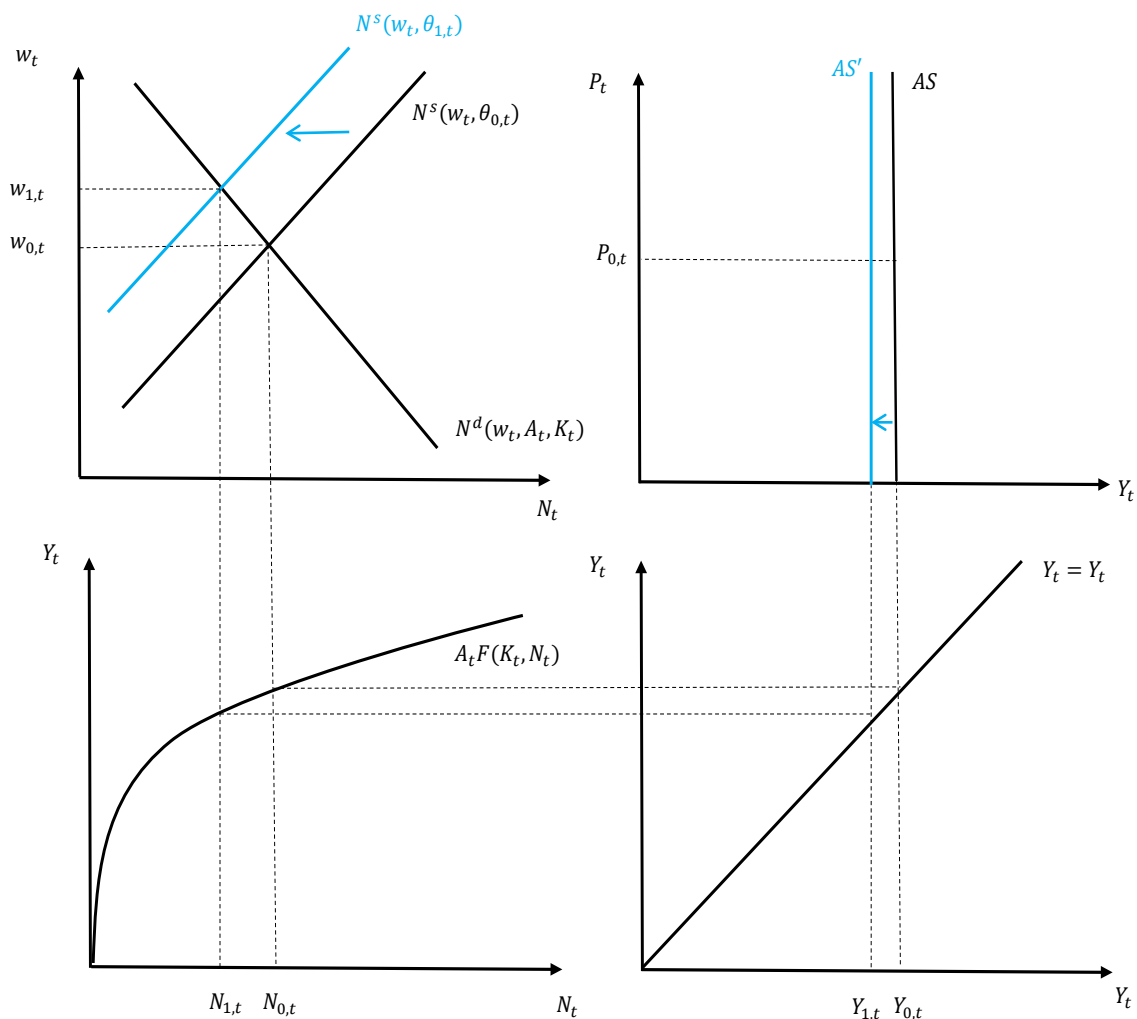

Table 24.1 summarizes how changes in relevant exogenous variables qualitatively shift the neoclassical AS curve.

Table 24.1: Neoclassical AS Curve Shifts

Change in Variable	Direction of Shift of AS
$\uparrow A_t$	Right
$\uparrow \theta_t$	Left

Note that the shape of the neoclassical AS curve and its shifts are qualitatively identical to those for the Y^s curve. What is different is what variable appears on the vertical axis in

the upper right quadrant – P_t for the AS curve, r_t for the Y^s curve.

24.2 New Keynesian Model

New Keynesian models depart from the neoclassical model by assuming some form of nominal rigidity – in particular, either the price level or the nominal wage is “sticky” – i.e. imperfectly able to adjust in the short run. This stickiness results in a non-vertical AS curve. A non-vertical AS curve allows demand shocks to have real effects and alters the way in which the economy reacts to supply shocks. Importantly, the demand sides of the New Keynesian and neoclassical models are identical – the models differ only in their assumptions about aggregate supply. We focus on price stickiness as a motivating assumption for a non-vertical AS curve in the text. Appendix D considers a model of nominal wage stickiness.

We consider two different versions of the sticky price New Keynesian model. In the first, which we call the “simple sticky price model,” the aggregate price level is completely fixed (i.e. exogenous) in the short run, which generates a completely horizontal AS curve. In the “partial sticky price model,” we assume that the aggregate price level has an exogenous component in the short run, but may also react to deviations of output relative to the neoclassical case. This model nests both the neoclassical and simple sticky price models.

24.2.1 Simple Sticky Price Model

We begin with a very simple model of nominal rigidity, wherein the aggregate price level is exogenously fixed in the short run. Some friction (such as a “menu cost” which makes it prohibitively expensive to adjust the dollar price of goods) gives rise to the price level being fixed within a period. Assuming that the price level is exogenous within period is an admittedly extreme form of price stickiness. For this reason, we refer to this version of a sticky price model as the “simple sticky price model.” In Section 24.2.2 below, we consider an alternative specification in which the aggregate price level is only partially sticky.

Denote the exogenous price level by \bar{P}_t . Although we treat this as exogenous from the perspective of the short run, one can think about \bar{P}_t as being chosen *prior* to period t as the price level which in expectation would result in the neoclassical equilibrium level of output. The neoclassical level of output is what the firm would optimally like to produce. Hence, we can think about it setting \bar{P}_t *prior* to observing any exogenous variables so that *in expectation* it would be at its optimal production scale. If exogenous variables are different than what the firm expected, then it will end up having to produce more (or less) than it would optimally like because of the pricing friction.

We assume that the “rules of the game” are as follows. Given \bar{P}_t , the firm is required to

produce as much output as is demanded at this price. The amount of output demanded at this price is given by the AD curve (derived in Chapter 23) evaluated at \bar{P}_t . Given this level of output, the firm must then choose N_t to be consistent with this level of output. In other words, N_t is chosen to meet demand, rather than to maximize profit. Put slightly differently, the firm is “off” its labor demand curve in the Keynesian model. Given output demanded at \bar{P}_t , the firm has to hire sufficient labor to produce this output. It pays labor the real wage consistent with the labor supply curve at that level. In other words, relative to the neoclassical model, we are effectively replacing the labor demand curve with the condition that $P_t = \bar{P}_t$. The equations summarizing the supply side of the simple sticky price New Keynesian model are shown below:

$$N_t = N^s(w_t, \theta_t) \tag{24.4}$$

$$P_t = \bar{P}_t \tag{24.5}$$

$$Y_t = A_t F(K_t, N_t) \tag{24.6}$$

The graphical derivation of the simple sticky price AS curve is particularly simple. The AS curve is the set of (P_t, Y_t) pairs consistent with equations (24.4)-(24.6) all holding. But since the price level is fixed by assumption, the AS curve is simply a horizontal line at \bar{P}_t . Any number of values of Y_t are consistent with $P_t = \bar{P}_t$. This is shown in Figure 24.4 below:

Figure 24.4: The Simple Sticky Price AS Curve: Derivation

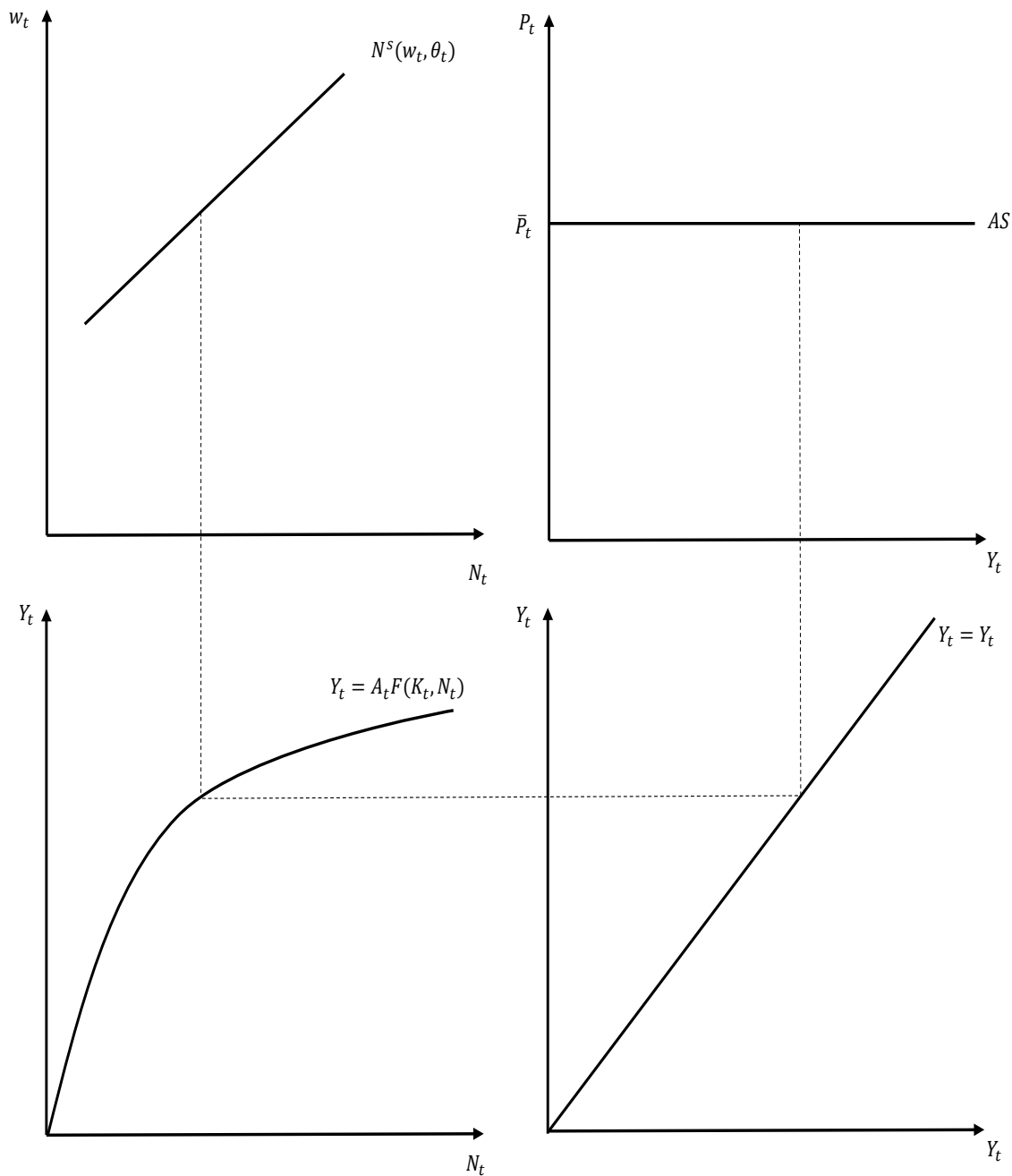

Because the price level is now exogenous, the sticky price AS curve will not shift if either A_t or θ_t change. The sticky price AS curve will only shift if \bar{P}_t were to change exogenously. This is shown in Figure 24.5 below:

Figure 24.5: Shift of the Simple Sticky Price AS Curve: Increase in \bar{P}_t

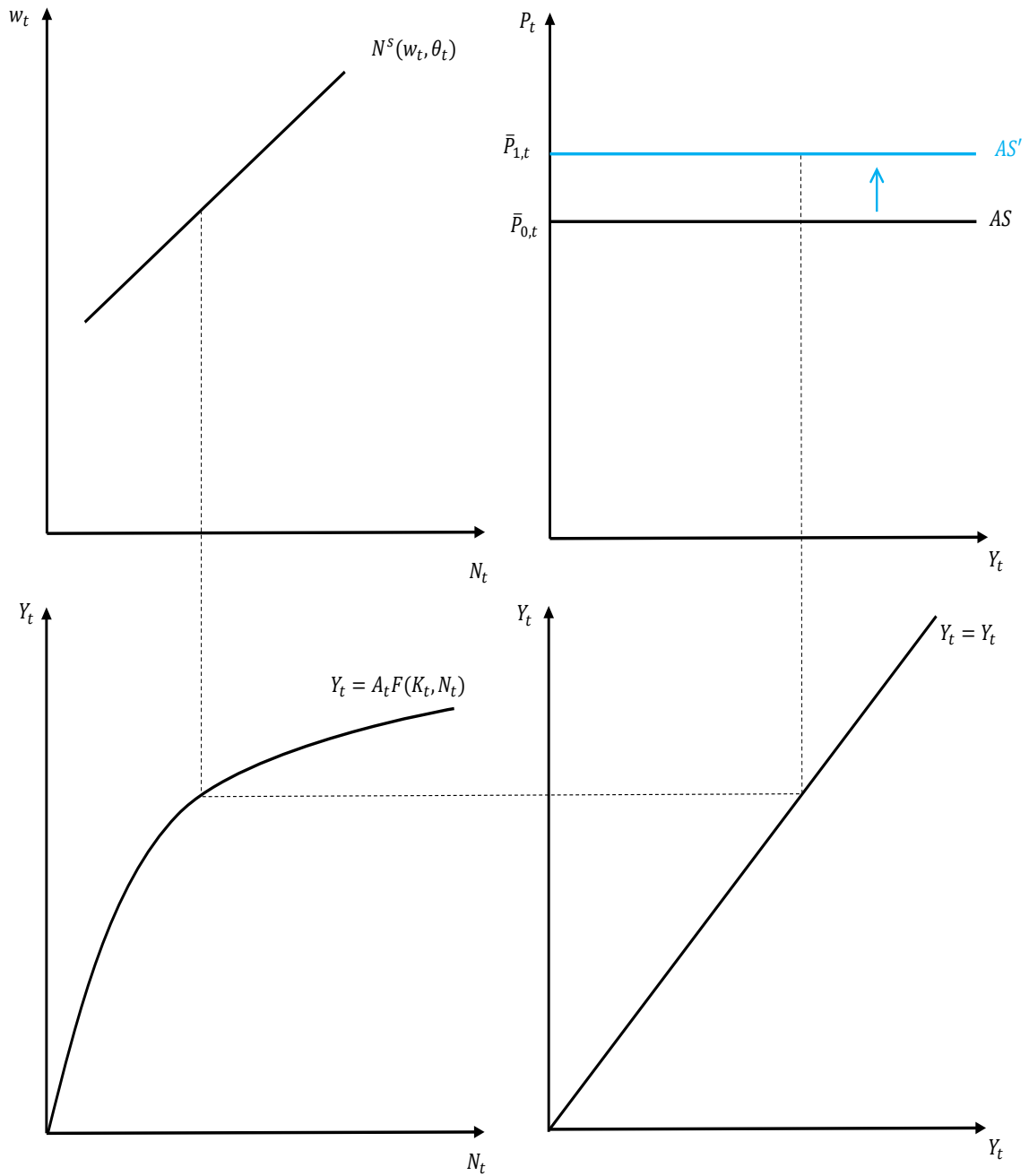

Table 24.2 summarizes how the simple sticky price AS curve shifts in response to changes in exogenous variables. To reiterate, the sticky price AS curve only shifts if \bar{P}_t changes.

Table 24.2: Simple Sticky Price AS Curve Shifts

Change in Variable	Direction of Shift of AS
$\uparrow A_t$	No Shift
$\uparrow \theta_t$	No Shift
$\uparrow \bar{P}_t$	Up

24.2.2 Partial Sticky Price Model

In Section 24.2.1, we assume that the aggregate price level is predetermined and hence exogenous within a period. This is an extreme form of price stickiness, as it means that the price level cannot adjust (within a period) to exogenous shocks. In this section we consider an alternative version of this model in which the price level is partially sticky.

The partial sticky price AS block of the model is given by the following equations:

$$N_t = N^s(w_t, \theta_t) \quad (24.7)$$

$$P_t = \bar{P}_t + \gamma(Y_t - Y_t^f) \quad (24.8)$$

$$Y_t = A_t F(K_t, N_t) \quad (24.9)$$

In these equations, (24.8) is the AS curve. \bar{P}_t is again exogenous and can be thought of as the predetermined component of the aggregate price level. Y_t is the equilibrium level of output, and Y_t^f is the equilibrium level of output which would obtain if prices were flexible, hence the f superscript. We will sometimes refer to this as the “neoclassical level of output.” The parameter $\gamma \geq 0$ represents how sticky prices are. In the extreme, if $\gamma = 0$, then the aggregate price level is completely sticky, and the AS curve reverts to the perfectly horizontal AS curve from the simple sticky price model. At the other extreme, as $\gamma \rightarrow \infty$, we must have $Y_t = Y_t^f$. In other words, the parameter γ nests both the neoclassical case (a vertical AS curve at Y_t^f , determined by the production function and labor demand and supply intersecting) and the extreme case where the AS curve is horizontal at \bar{P}_t . Intermediate values of γ give an upward-sloping, but non-vertical and non-horizontal, AS.

Mathematically, Y_t^f can be found as the solution to the following system of equations:

$$N_t^f = N^s(w_t^f, \theta_t) \quad (24.10)$$

$$N_t^f = N^d(w_t^f, A_t, K_t) \quad (24.11)$$

$$Y_t^f = A_t F(K_t, N_t^f) \quad (24.12)$$

Expressions (24.10)-(24.12) constitute three equations in three endogenous variables – N_t^f , w_t^f , and Y_t^f . Note that these are exactly the same three equations as those characterizing the supply side of the neoclassical model, (24.1) - (24.3), just with f superscripts.

Figure 24.6 plots the supply side graphs for the partial sticky price model. The labor demand curve is shown in orange. This is because, as can be seen in (24.7)-(24.9), the labor demand curve is not *directly* relevant for the supply side of the model. It is, however, *indirectly* relevant because it helps to determine Y_t^f (see equations (24.10)-(24.12)). In particular, Y_t^f is found by first finding the N_t where labor supply intersects labor demand, and then plugging that value of N_t into the production function.

Figure 24.6: The Partial Sticky Price AS Curve: Derivation

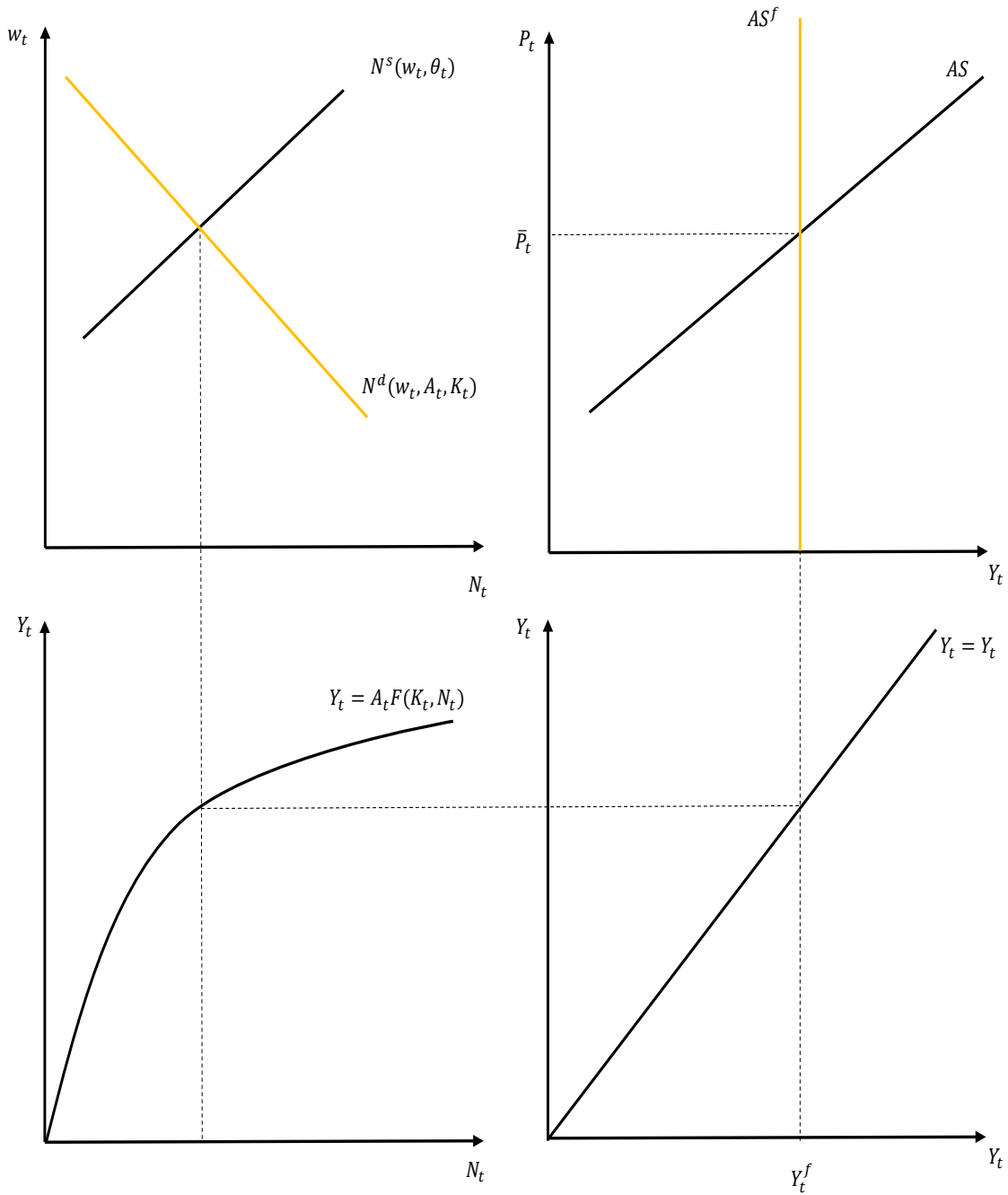

The AS curve has slope of γ (which is an exogenous parameter in the model) and passes through the point Y_t^f at $P_t = \bar{P}_t$, where \bar{P}_t is exogenous. This can be seen in the graph above, where we plot (in orange) what the AS curve would look like in the neoclassical model. This is simply a vertical line at Y_t^f , and is denoted AS^f . The upward-sloping AS curve crosses the hypothetical AS^f curve at $P_t = \bar{P}_t$.

In Figure 24.7, we document how the value of γ impacts the slope of the AS curve. Regardless of γ , the AS curve crosses the point $Y_t = Y_t^f$ at $P_t = \bar{P}_t$. Large values of γ correspond to relatively flexible prices and result in an AS curve that is comparatively steep; the reverse is true for smaller values of γ . Once again, one can think of the neoclassical AS curve (i.e. Figure 24.1) as a special case of Figure 24.6 with $\gamma \rightarrow \infty$, and the simple sticky price AS curve (i.e. Figure 24.4) as a special case when $\gamma = 0$.

Figure 24.7: The Partial Sticky Price AS Curve: Role of γ

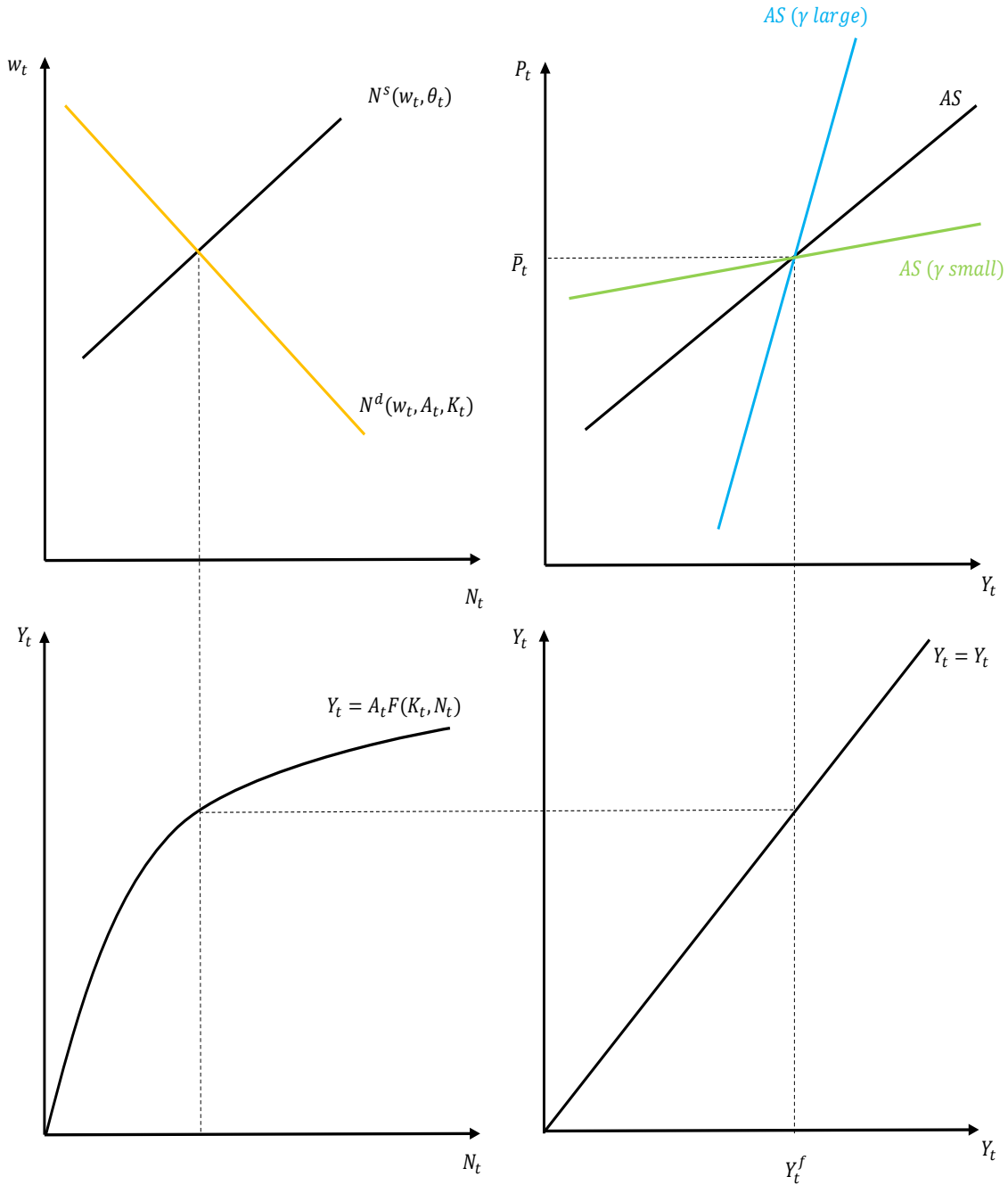

Recall that the AS curve is given by $P_t = \bar{P}_t + \gamma(Y_t - Y_t^f)$. Therefore, the AS curve will shift if \bar{P}_t or Y_t^f change. Intuitively, since the AS curve must cross the hypothetical AS^f curve at $P_t = \bar{P}_t$, an increase in \bar{P}_t (which by construction does not affect Y_t^f) must result in the AS curve shifting up. This is qualitatively the same as what happens in the partial sticky price model. What is different than the simple sticky price model is that anything

which causes Y_t^f to increase will also cause the AS curve to shift. This means that exogenous variables like A_t and θ_t will cause the partial sticky price curve to shift, unlike in the simple sticky price model.

Figure 24.8 shows the case where there is an exogenous increase in \bar{P}_t . This results in the AS curve shifting upward – Y_t^f is unaffected, and the AS curve must cross the point $Y_t = Y_t^f$ at the new, higher value of \bar{P}_t . Hence, the AS shifts up. Again, this is qualitatively the same as in the simple sticky price model, except that the AS curve is here upward-sloping rather than horizontal.

Figure 24.8: Shift of the Partial Sticky Price AS Curve: $\uparrow \bar{P}_t$

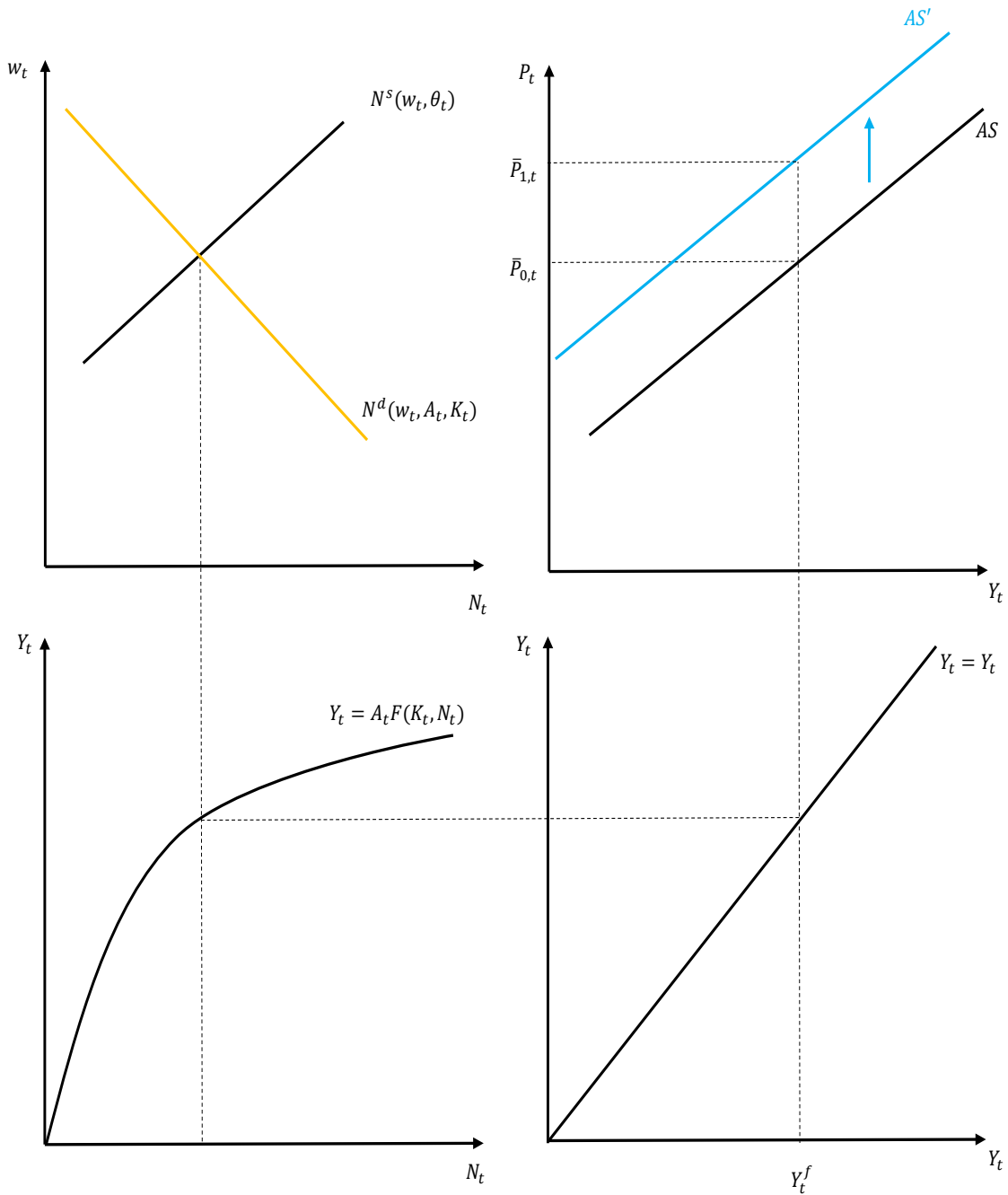

The partial sticky price AS curve will also shift if an exogenous variable changes which impacts Y_t^f . The exogenous variables which may do so are A_t , θ_t , and K_t . We will not consider changes in K_t in the text. Consider first an exogenous increase in A_t . This would shift the hypothetical labor demand curve to the right, which in conjunction with the production function shifting up would result in Y_t^f rising. This results in the AS curve shifting horizontally

to the right, as shown in Figure 24.9.

Figure 24.9: Shift of the Partial Sticky Price AS Curve: $\uparrow A_t$

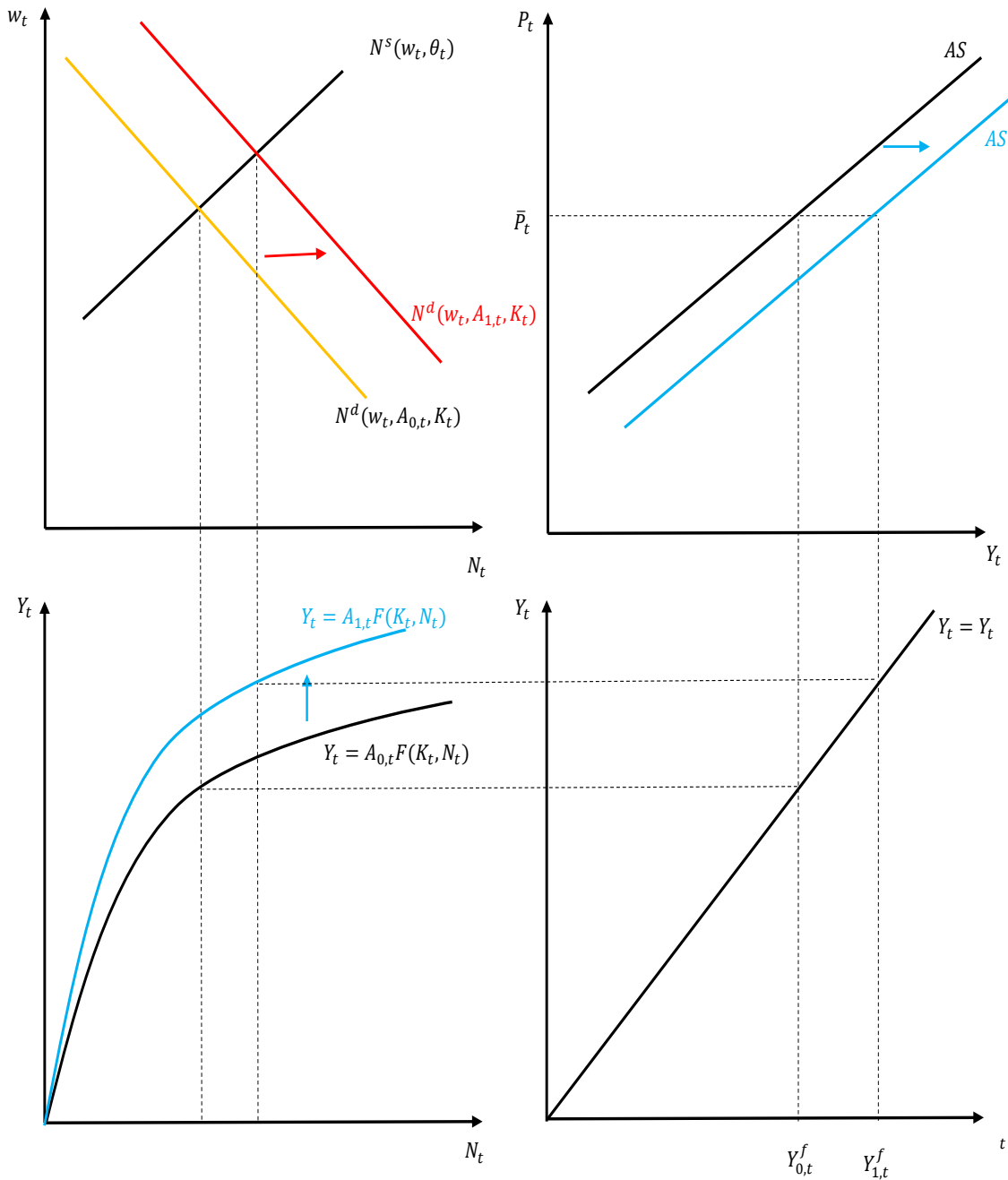

Next, consider an exogenous increase in θ_t . This would result in the labor supply curve shifting in, which would lower the equilibrium level of labor input if prices were flexible. This would result in a lower value of Y_t^f , and a resulting inward shift of the AS curve. This is shown in Figure 24.10 below.

Figure 24.10: Shift of the Partial Sticky Price AS Curve: $\uparrow \theta_t$

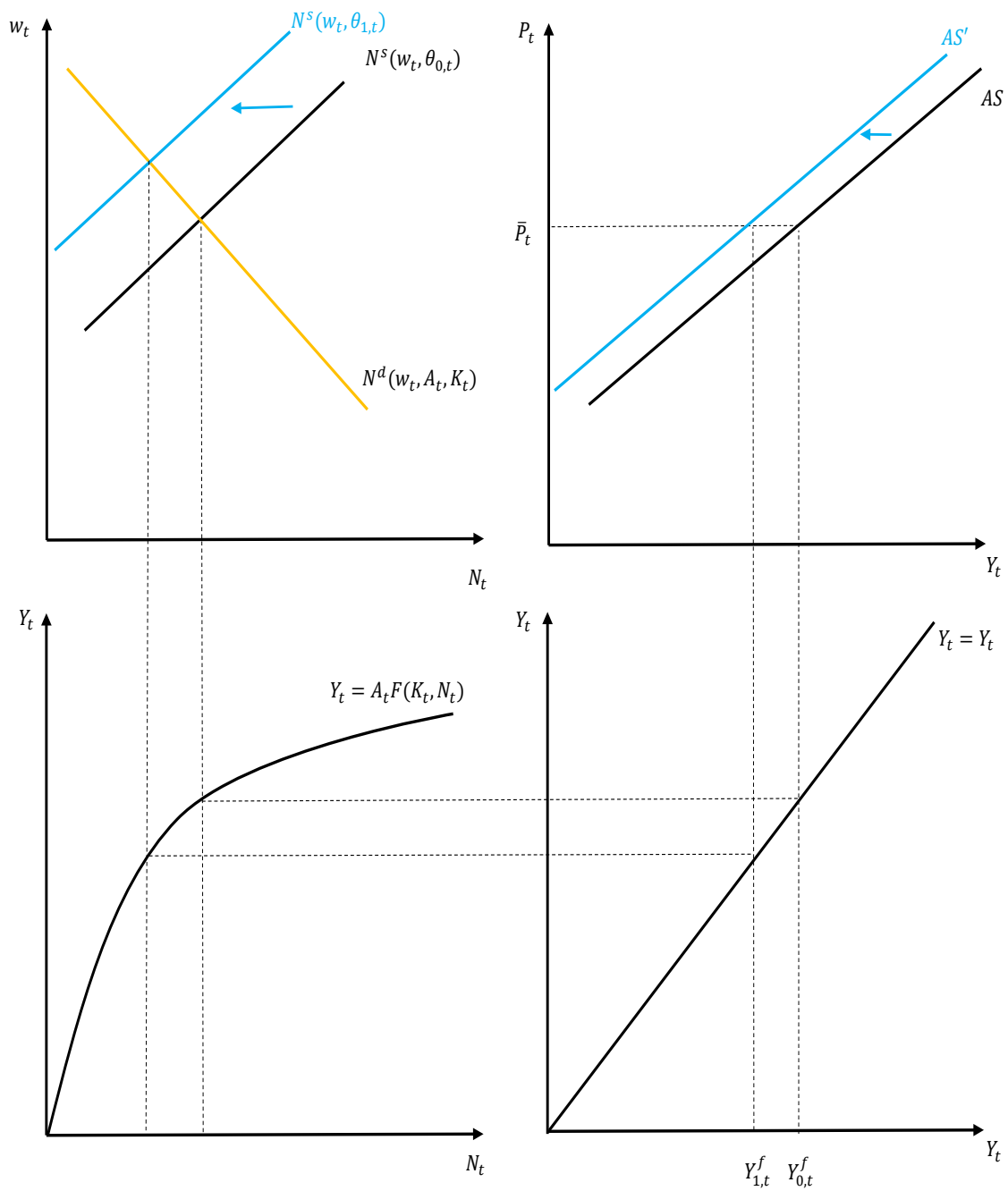

Table 24.3 below qualitatively shows how the partial sticky price AS curve shifts in response to different exogenous variables.

Table 24.3: Partial Sticky Price AS Curve Shifts

Change in Variable	Direction of Shift of AS
$\uparrow A_t$	Right
$\uparrow \theta_t$	Left
$\uparrow \bar{P}_t$	Up

The qualitative results summarized in Table 24.3 differ relative to Table 24.2 for the simple sticky price model in that changes in A_t and θ_t cause horizontal shifts of the AS curve in the partial sticky price model. Holding \bar{P}_t fixed, the horizontal shift of the AS curve in the partial sticky price model is equal to the change in Y_t^f . In both the partial and simple sticky price models, exogenous changes in \bar{P}_t cause the AS curve to shift up or down. Because A_t and θ_t trigger horizontal shifts of the AS curve, if the AS curve is already perfectly horizontal as in the simple sticky price model, it cannot shift when these exogenous variables change.

24.3 Summary

- The aggregate supply, or AS curve, shows the set of (P_t, Y_t) pairs consistent with the production function and some notion of equilibrium in the labor market.
- Referencing back to the neoclassical model, the three equations characterizing the supply side of the economy are the labor demand curve, the labor supply curve, and the production function. Because P_t does not appear in any of these three curves, the neoclassical AS curve is vertical.
- New Keynesian models differ from the neoclassical counterpart in assuming some kind of nominal rigidity. This generates a non-vertical AS curve.
- In the simple sticky price model, we assume that the price level is exogenous. This means, rather mechanically, that the AS curve is horizontal. The firm is off its labor demand curve, with labor input being determined from aggregate demand and the real wage from the labor supply curve.
- In the partial sticky price model, we assume that the price level is partially exogenous and partially depends on the output gap, or the difference between equilibrium output, Y_t , and what output would be in the neoclassical model, Y_t^f . The AS curve is given by $P_t = \bar{P}_t + \gamma(Y_t - Y_t^f)$. The parameter $\gamma \geq 0$ governs how sticky prices are. It nests two special cases: $\gamma = 0$ corresponds to the simple sticky price model, and $\gamma \rightarrow \infty$

corresponds to the neoclassical model. Like the simple sticky price model, labor input (and the real wage) is determined from the labor supply curve.

- It is important to note that the New Keynesian model differs in only one small dimension from the neoclassical model – we replace the labor demand curve with a fixed price (or the partial price stickiness AS curve). Otherwise, the models are identical.

Key Terms

- Nominal rigidity

Questions for Review

1. Define the simple sticky price AS curve.
2. Define the partial sticky price AS curve. What is the role of the parameter γ ?
3. How are New Keynesian models different from the Neoclassical model?
4. What variables cause the simple sticky price AS curve to shift? What variables cause the sticky-wage AS curve to shift?

Chapter 25

Effect of Shocks in the New Keynesian Model

In this chapter, we use the graphical tools developed in Chapters 23 and 24 to analyze how the endogenous variables react to changes in the different exogenous variables in the sticky price New Keynesian model. We will do so for both the simple sticky price and partial sticky price models. But first, we examine how the IS-LM-AD-AS curves can be used to think about the effects of changes in exogenous variables in the neoclassical model. While the answers are identical to what obtained earlier using the IS and Y^s curves, this exercise facilitates a direct comparison between the different models. We conclude the chapter by comparing and contrasting the equilibrium effects of changes in exogenous variables in the different models.

25.1 The Neoclassical Model

As noted immediately above, we can use the IS-LM-AD-AS curves in the neoclassical model to analyze the effects of changes in the exogenous variables on the endogenous variables. The effects are identical to what obtains using the IS and Y^s curves as we did before, but it is instructive to use the IS-LM-AD-AS curve so as to make a comparison between the New Keynesian and neoclassical models.

The graphical depiction of the equilibrium of the neoclassical model using the IS-LM-AD-AS curves is shown below in Figure 25.1. The differences relative to either variant of the New Keynesian model are that the AS curve is vertical and the economy is simultaneously on both the labor demand and supply curves.

Figure 25.1: Neoclassical IS-LM-AD-AS Equilibrium

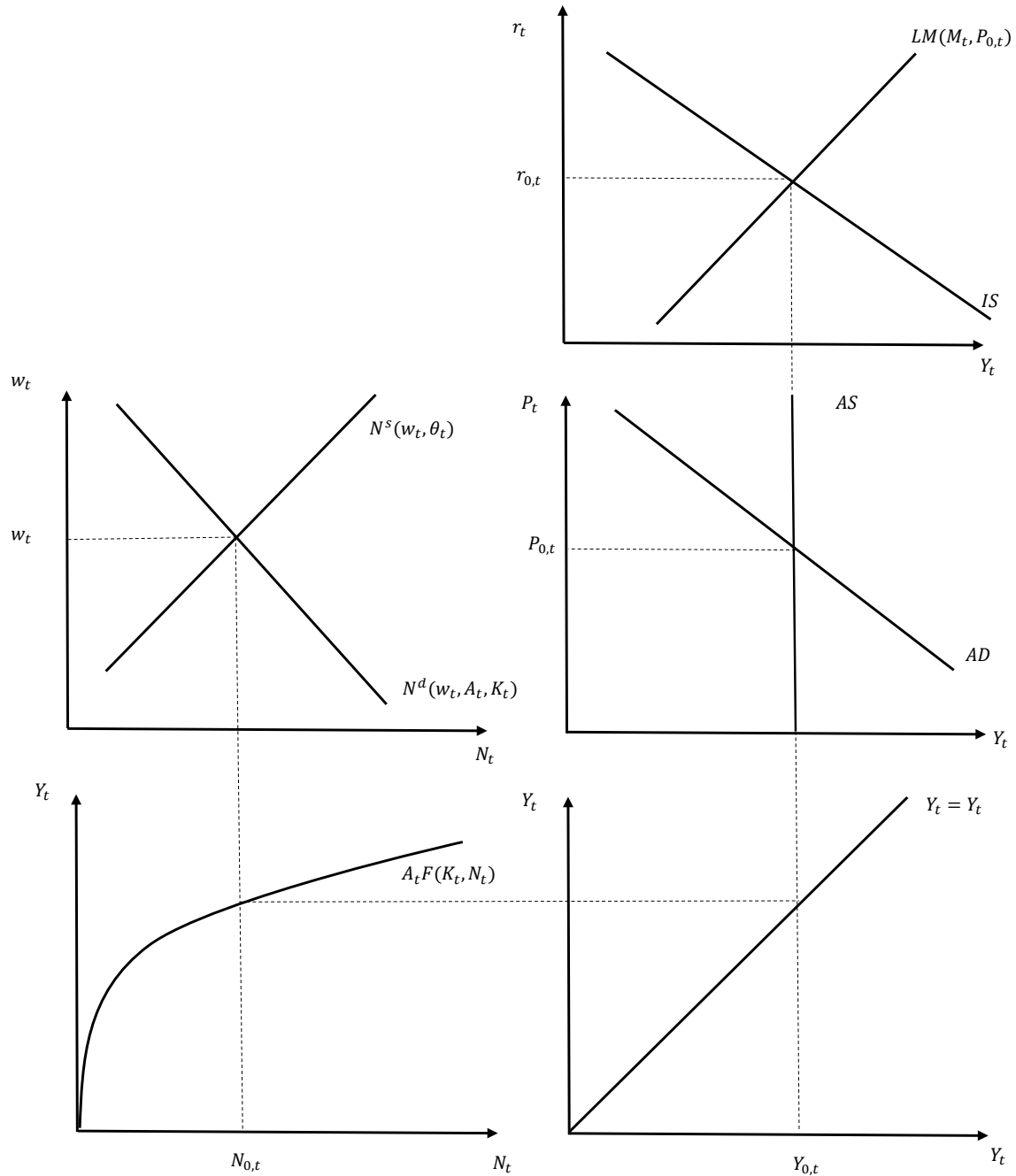

The neoclassical model differs from the New Keynesian model in that (i) the economy is simultaneously on both labor demand and supply curves and (ii) the AS curve is vertical. Whereas in the New Keynesian model output is determined by the intersection of the AD and AS curves and the equilibrium quantity of labor input must be consistent with this, in the neoclassical model labor input is determined by the intersection of labor demand and

supply, which determines the position of the vertical AS curve.

In the exercises which follow, black lines denote the various curves prior to a change in an exogenous variable, while blue lines depict shifts of curves after an exogenous variable has changed. Where relevant, a green line denotes a shift of the LM curve arising due to a change in P_t . A 0 subscript denotes the equilibrium value of a variable prior to a change in an exogenous variable, while a 1 subscript denotes the value of an endogenous variable after an exogenous variable has changed.

Consider first an exogenous increase in M_t . These effects are depicted graphically in Figure 25.2. The black lines show the curves representing the original equilibrium. The blue lines show the new curves as a direct consequence of the shock. The green line refers to the indirect effect on the position of the LM curve from a change in the price level. The increase in the money supply results in the LM curve shifting out to the right. Holding the price level fixed at $P_{0,t}$, this results in a higher value of output where the IS and LM curves intersect. This means that there is a rightward shift of the AD curve. Since the AS curve is vertical, there is no change in output in equilibrium. The price level rises to $P_{1,t}$. The higher price level causes the LM curve to shift back in to the left (depicted via the green arrow). The LM curve ends up in the same position where it originally was. There is no change in the real interest rate or any labor market variables.

In the neoclassical model, money is neutral. A simple way to think about this is that the central bank cannot affect real money balances, $\frac{M_t}{P_t}$. When the central bank adjusts M_t , in equilibrium P_t just adjusts proportionally so that the ratio $\frac{M_t}{P_t}$ is unchanged. Since the position of the LM curve depends on the level of real balances, in equilibrium the central bank cannot affect the position of the LM curve.

Figure 25.2: Neoclassical Model: Increase in M_t

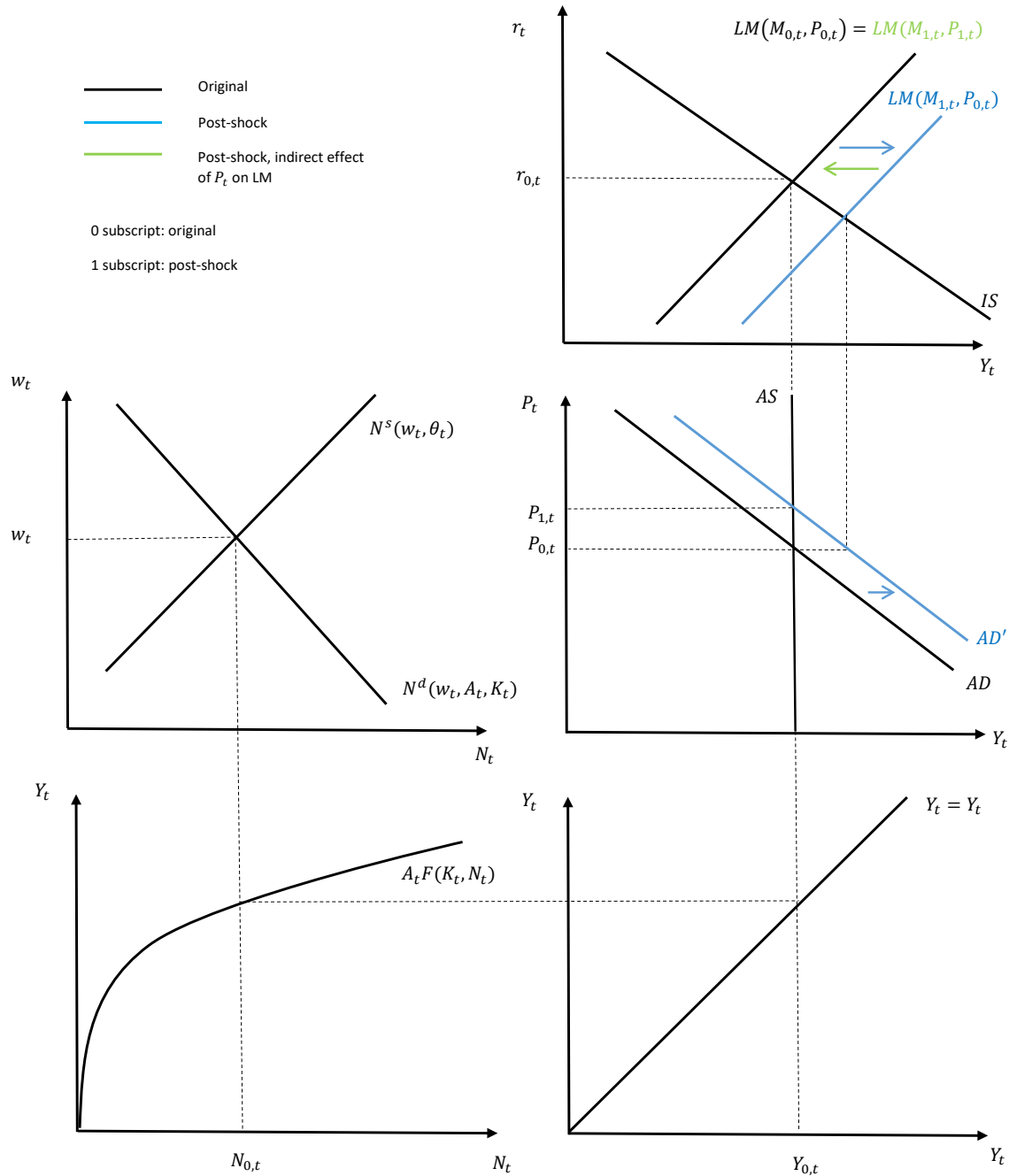

Consider next an exogenous increase in A_t . The effects of this are depicted in Figure 25.3. The labor demand curve shifts to the right. This result in a higher real wage and a higher level of labor input. The production function shifts up. With more labor input and more productivity, output rises. The AS curve shifts out to the right. This results in higher output and a lower price level. The lower price level causes the LM curve to shift to the right (shown

in green) in such a way that it intersects the IS curve at the same level of output where the AD and AS curves intersect. The real interest rate falls. The decrease in the real interest rate is necessary to stimulate private expenditure (C_t and I_t) so that expenditure/income rises to the new higher level of production.

Figure 25.3: Neoclassical Model: Increase in A_t

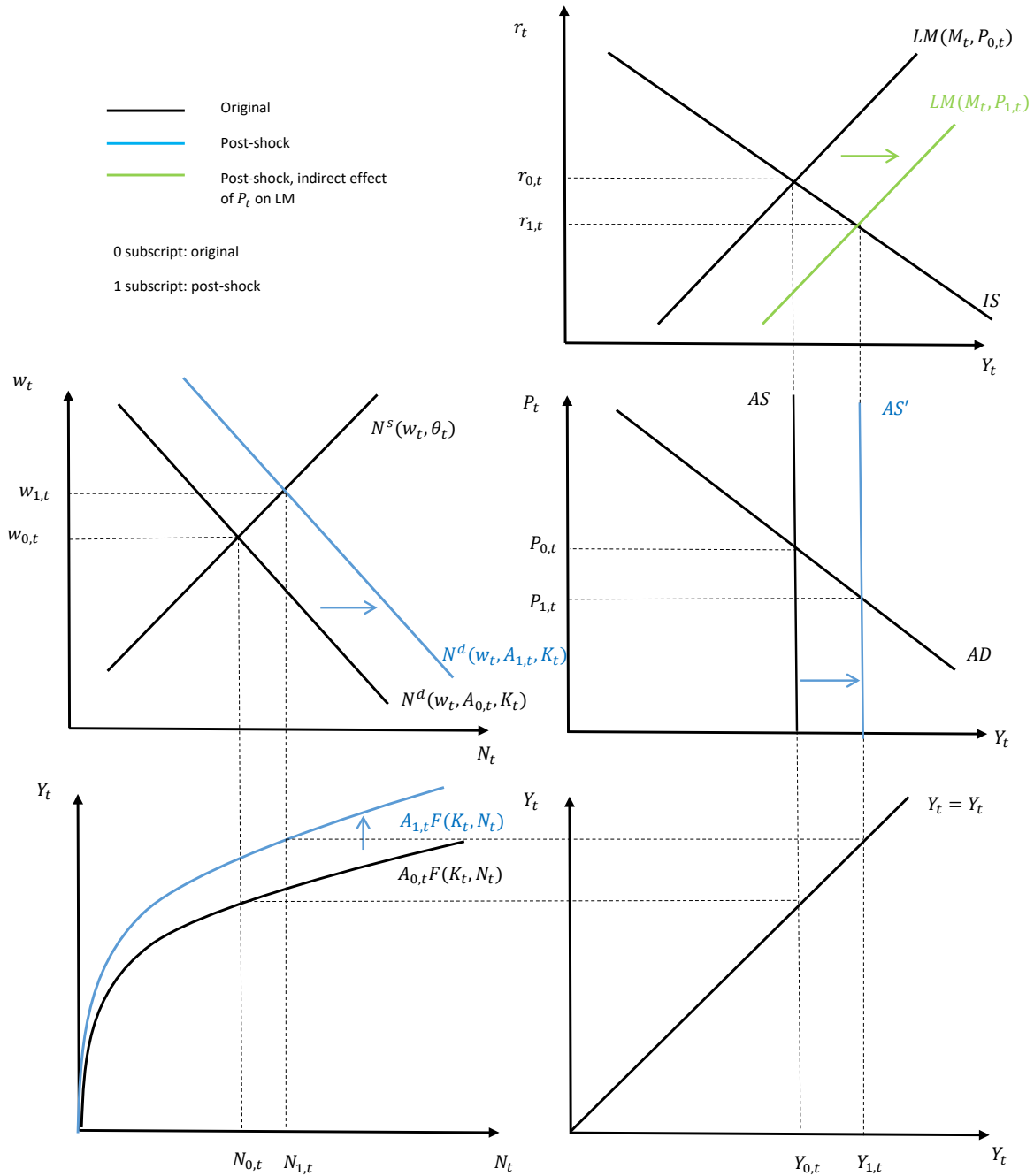

Now suppose that there is a change in an exogenous variable which causes the IS curve to

shift to the right (an increase in A_{t+1} or G_t , or a decrease in G_{t+1}). Holding the price level fixed, this would result in a higher value of output where the IS and LM curves intersect. Consequently, the AD curve shifts out to the right. But with a vertical AS curve, there is no change in output in equilibrium. The price level rises. The increase in the price level causes the LM curve to shift in to the left (shown in green) by an amount such that the new LM curve intersects the new IS curve at an unchanged level of output. The real interest rate increases. There are no changes in labor market variables.

Figure 25.4: Neoclassical Model: Positive IS Shock

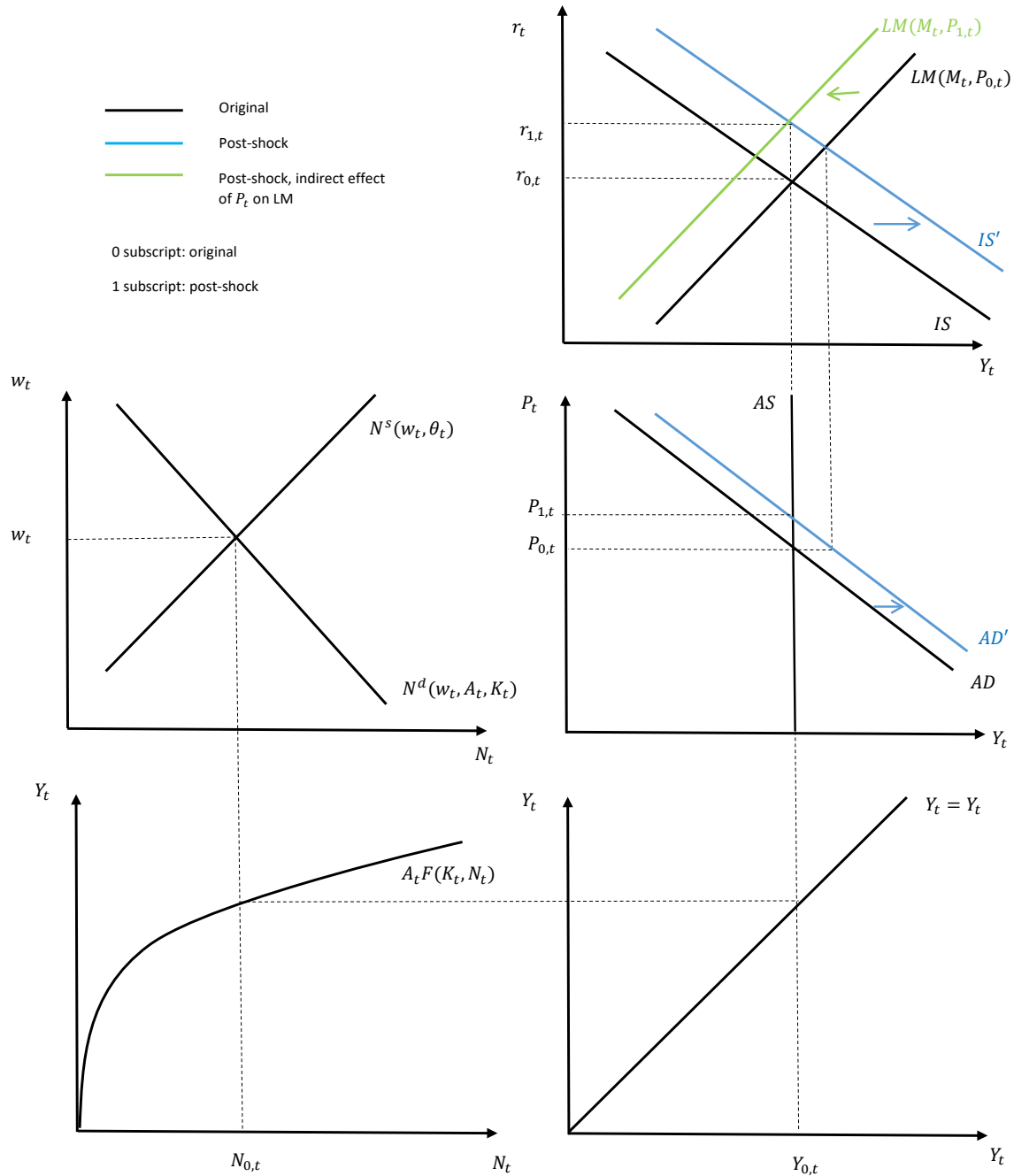

We leave a graphical analysis of the effects of an increase in θ_t as an exercise. Table 25.1 summarizes the qualitative effects of changes in different exogenous variables in the neoclassical model. It is worth repeating that these effects are the same which we encountered earlier using a different set of graphs. They are just included here for completeness.

Table 25.1: Qualitative Effects of Exogenous Shocks on Endogenous Variables in the Neoclassical Model

Variable	Exogenous Shock		
	$\uparrow M_t$	\uparrow IS curve	$\uparrow A_t$
Y_t	0	0	+
N_t	0	0	+
w_t	0	0	+
r_t	0	+	-
i_t	0	+	-
P_t	+	+	-

25.2 Simple Sticky Price Model

We next consider the simple sticky price model. The equations characterizing the equilibrium of the simple sticky price model are given below:

$$C_t = C^d(Y_t - G_t, Y_{t+1} - G_{t+1}, r_t) \quad (25.1)$$

$$N_t = N^s(w_t, \theta_t) \quad (25.2)$$

$$P_t = \bar{P}_t \quad (25.3)$$

$$I_t = I^d(r_t, A_{t+1}, K_t) \quad (25.4)$$

$$Y_t = A_t F(K_t, N_t) \quad (25.5)$$

$$Y_t = C_t + I_t + G_t \quad (25.6)$$

$$M_t = P_t M^d(r_t + \pi_{t+1}^e, Y_t) \quad (25.7)$$

$$r_t = i_t - \pi_{t+1}^e \quad (25.8)$$

These are identical to the neoclassical model, except the price level is now equal to an exogenous variable, \bar{P}_t . This means that the AS curve is horizontal at $P_t = \bar{P}_t$. The endogenous variables of the model are Y_t , N_t , C_t , I_t , r_t , i_t , P_t , and w_t . This is eight endogenous variables (with eight equations). The exogenous variables of the model are A_t , A_{t+1} , G_t , G_{t+1} , M_t , π_{t+1}^e , θ_t , and \bar{P}_t . The AD curve summarizes the IS and LM curves, and is identical to the neoclassical model. Figure 25.5 graphically summarizes the equilibrium of the simple sticky

price model. We denote the initial equilibrium with a 0 subscript.

Figure 25.5: Equilibrium in the Simple Sticky Price Model

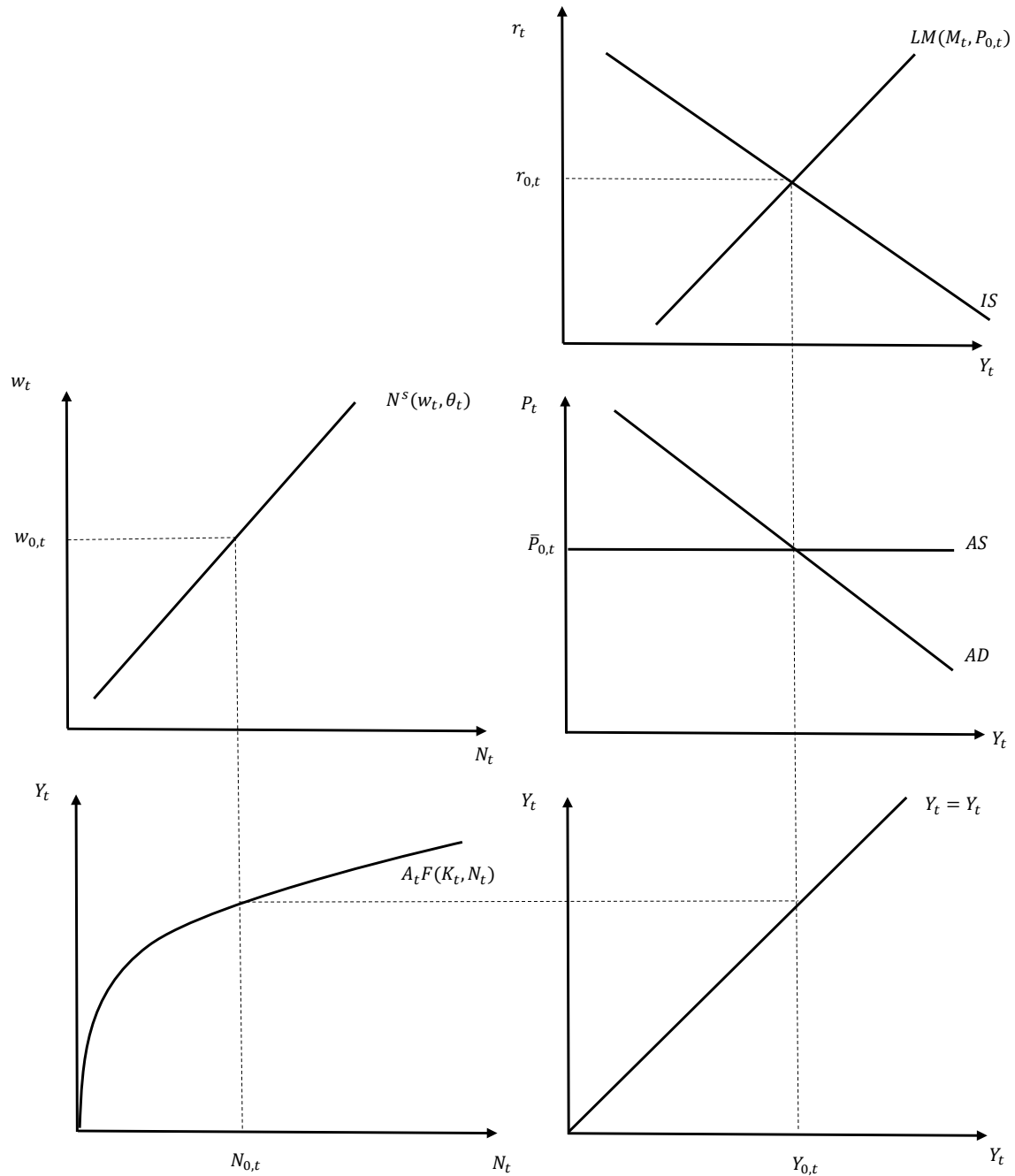

There is a key difference relative to the neoclassical model, which is evident in the equations presented above. In particular, the quantity of labor input is determined, in a sense, “after” output is determined. Put a little differently – output is determined by the intersection of the AD and AS curves. Since the AS curve is horizontal, output is effectively

determined by the position of the AD curve. Then, once output is known, N_t is determined to be consistent with this. In the sticky price model, the real wage is determined as being consistent with this quantity of labor on the labor supply curve. In the neoclassical model, as we saw above, things are reversed, in a sense. Labor is determined by the intersection of labor demand and supply. This determines output (since the AS curve is vertical).

Consider first an exogenous increase in M_t , from $M_{0,t}$ to $M_{1,t}$. The effects are depicted in Figure 25.6. The increase in the money supply results in a rightward shift of the LM curve. This raises the level of output at which the IS and LM curves intersect, resulting in an outward shift of the AD curve. Because the AS curve is perfectly horizontal, there is no change in the price level (and hence no indirect effect on the position of the LM curve). Hence, on net, output is higher and the real interest rate is lower. Higher output must be supported by an increase in labor input, from $N_{0,t}$ to $N_{1,t}$. To induce the household to work more, the firm has to pay a higher real wage, $w_{1,t}$. With the real interest rate lower, investment will be higher. With the real interest rate lower and output higher, consumption will also increase.

Figure 25.6: Simple Sticky Price: Effect of Increase in M_t

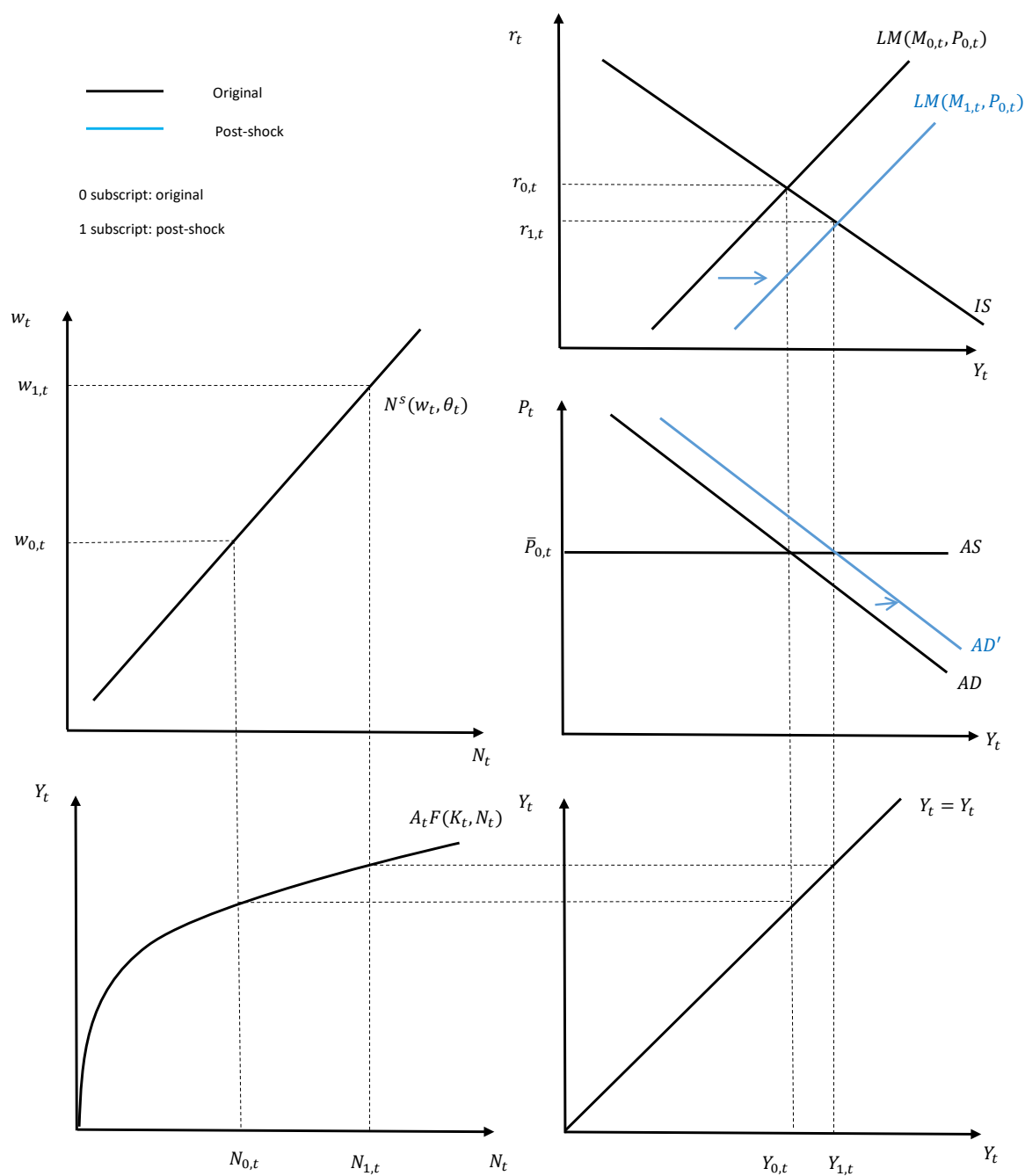

Changes in the money supply are non-neutral in this model in the sense that a change in the money supply leads to a change in real output. In the sticky price model, the increase in M_t results in a falling real interest rate. This lower real interest rate encourages consumption and investment to rise. To accommodate this rise in demand, the real wage must rise. In the neoclassical model (as we saw above), the price level rises so much that real money balances,

M_t/P_t , is unaffected, which negates the effect on the position of the LM curve and hence the real interest rate. Hence, in the sticky price model the “monetary transmission mechanism” is that price stickiness gives the central bank the ability to influence the equilibrium position of the LM curve and hence to impact the real interest rate. Change in the real interest rate influence aggregate demand and hence output.

Next, consider a positive shock to the IS curve. This could result from an increase in A_{t+1} or G_t , or a reduction in G_{t+1} . For the purposes of understanding how output qualitatively reacts, it is not important which exogenous variable is driving the outward shift of the IS curve. For the purposes of understanding how consumption and investment react, it is important to know which exogenous variable is changing and in which direction. These effects are shown graphically in Figure 25.7. The IS curve shifts to the right. This results in a rightward shift of the AD curve. Given the horizontal AS curve, the price level does not change and output increases by the full amount of the horizontal shift in the AD curve, with the real interest rate rising. This higher level of output must be met by higher labor input, $N_{1,t}$. The firm must pay a higher real wage, $w_{1,t}$, in order to induce the household to work more. Unlike the neoclassical model, the IS shock has a positive effect on output.

Figure 25.7: Simple Sticky Price: Effect of Positive IS Shock

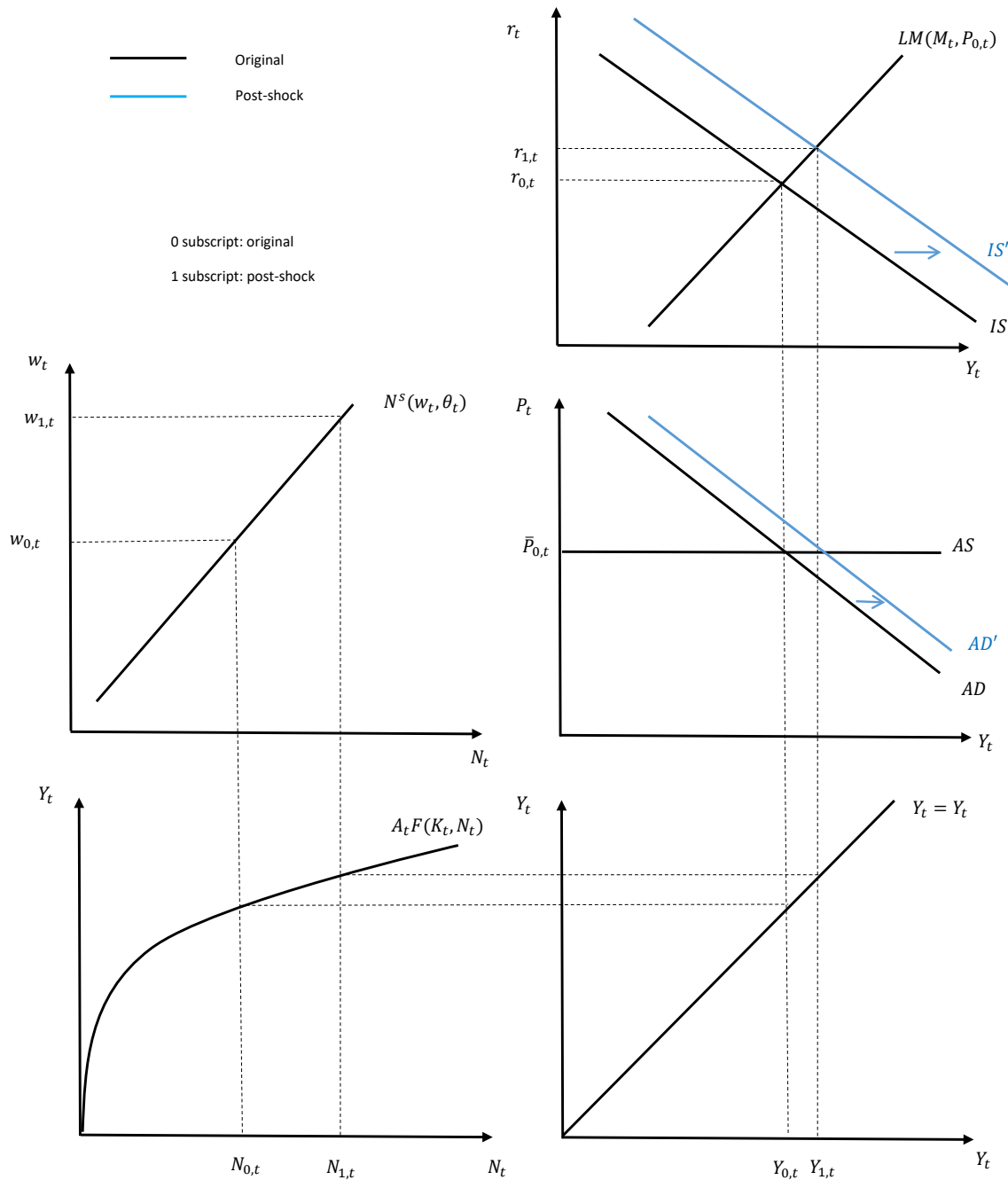
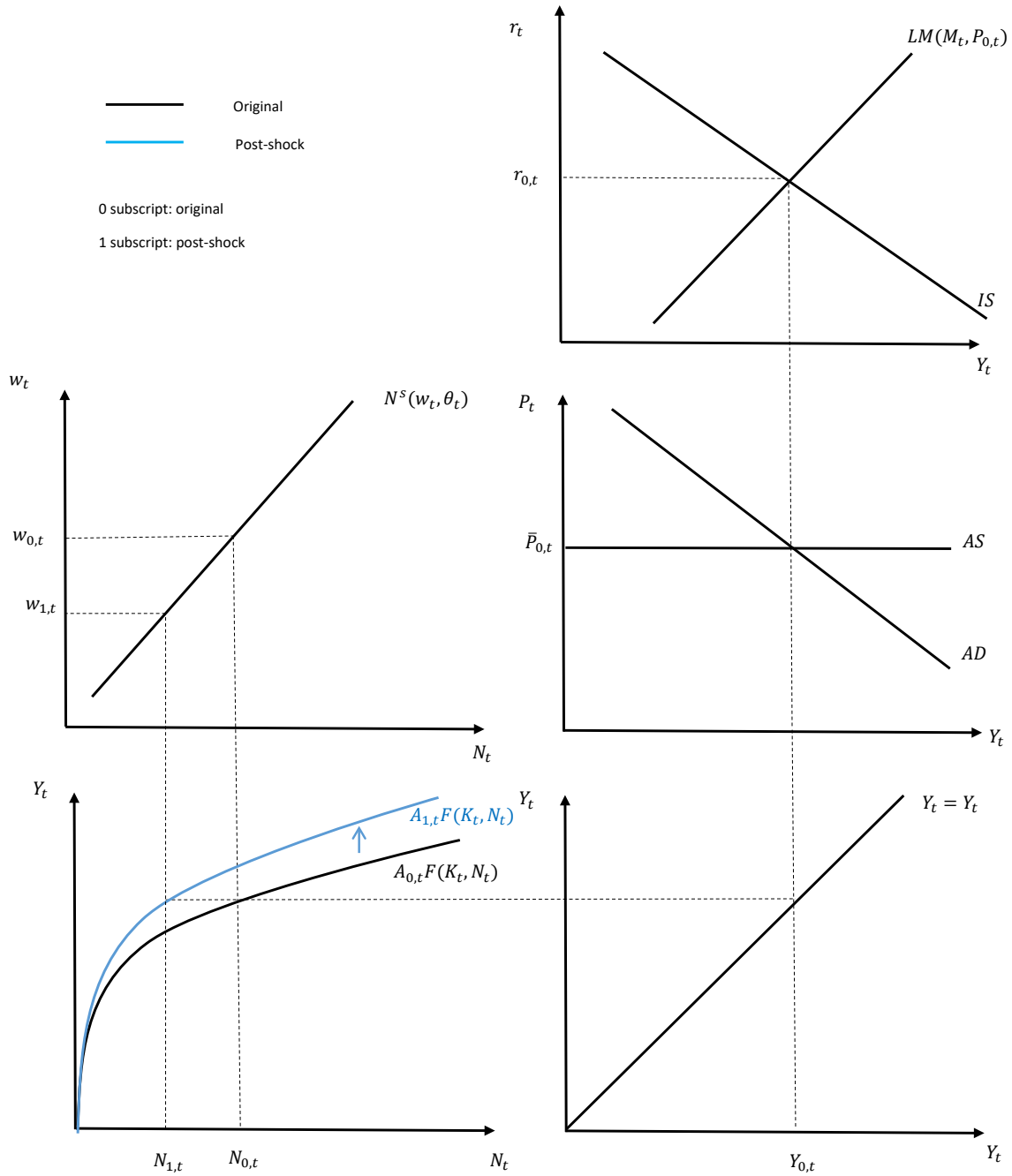

Figure 25.7 reveals another important point of departure relative to the neoclassical model. In the neoclassical model, shocks to the IS curve did not affect output, only how output was split between different expenditure categories. In the sticky price model, output does react to IS shocks. In a sense, what is going on is similar to why money is non-neutral. The sticky price level means that the LM curve cannot endogenously react to shocks to the IS curve.

This means that r_t reacts *less* to an IS shock than it does in the neoclassical model, which is what allows output to react *more* (compared to no reaction at all) relative to the neoclassical model.

Next, consider an increase in A_t . These effects are shown in Figure 25.8. Because the price level is fixed at $P_t = \bar{P}_t$, there is *no shift* of the AS curve. Hence, there is no change in Y_t , r_t , or in the components of total expenditure (consumption and investment). But since the production function shifts up, and there is no change in Y_t , labor input must fall, to $N_{1,t}$. This results in a movement down along the labor supply curve, with the real wage falling to $w_{1,t}$. Hence, labor input and the real wage fall after an increase in A_t in the sticky price model. When output is solely demand determined, as in the simple sticky price model, an increase in productivity results in *no change* in output and hence must be “contractionary” for labor market variables.

Figure 25.8: Simple Sticky Price: Effect of Increase in A_t



Next, consider an increase in θ_t . This is depicted graphically in Figure 25.9. Once again, as in the case of an increase in A_t , because the AS curve is horizontal at \bar{P}_t , there is *no shift* of the AS curve and hence no change in Y_t , r_t , or the expenditure components of Y_t . Since there is no shift of the production function and no change in Y_t , there must be no change in N_t in equilibrium either. But since the labor supply curve shifts in when θ_t rises, the only

effect in equilibrium will therefore be an increase in the real wage.

Figure 25.9: Simple Sticky Price: Effect of Increase in θ_t

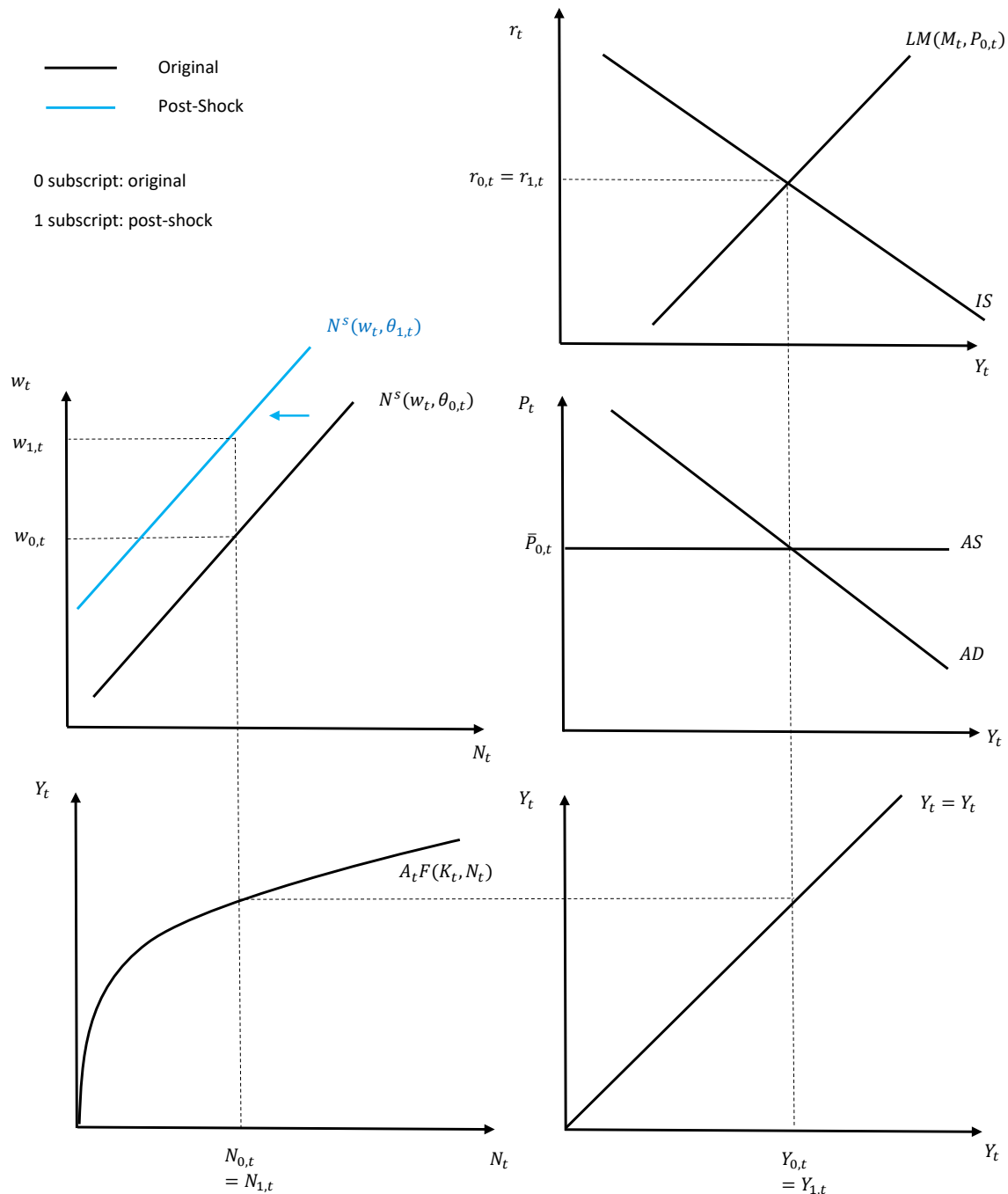

Finally, consider an increase in the exogenous price level, from $\bar{P}_{0,t}$ to $\bar{P}_{1,t}$. This is documented graphically in Figure 25.10. The horizontal AS curve shifts up. This results in a decrease in output to $Y_{1,t}$. The higher price level induces an inward shift of the LM curve (shown in green) so that the level of output where the IS and LM curves intersect corresponds

to the level of output where the AS and AD curves intersect. The real interest rate rises. With less output, there must be less labor input, with labor input falling to $N_{1,t}$. This results in a movement down along the labor supply curve, with the real wage falling as a result.

Figure 25.10: Simple Sticky Price: Effect of Increase in \bar{P}_t

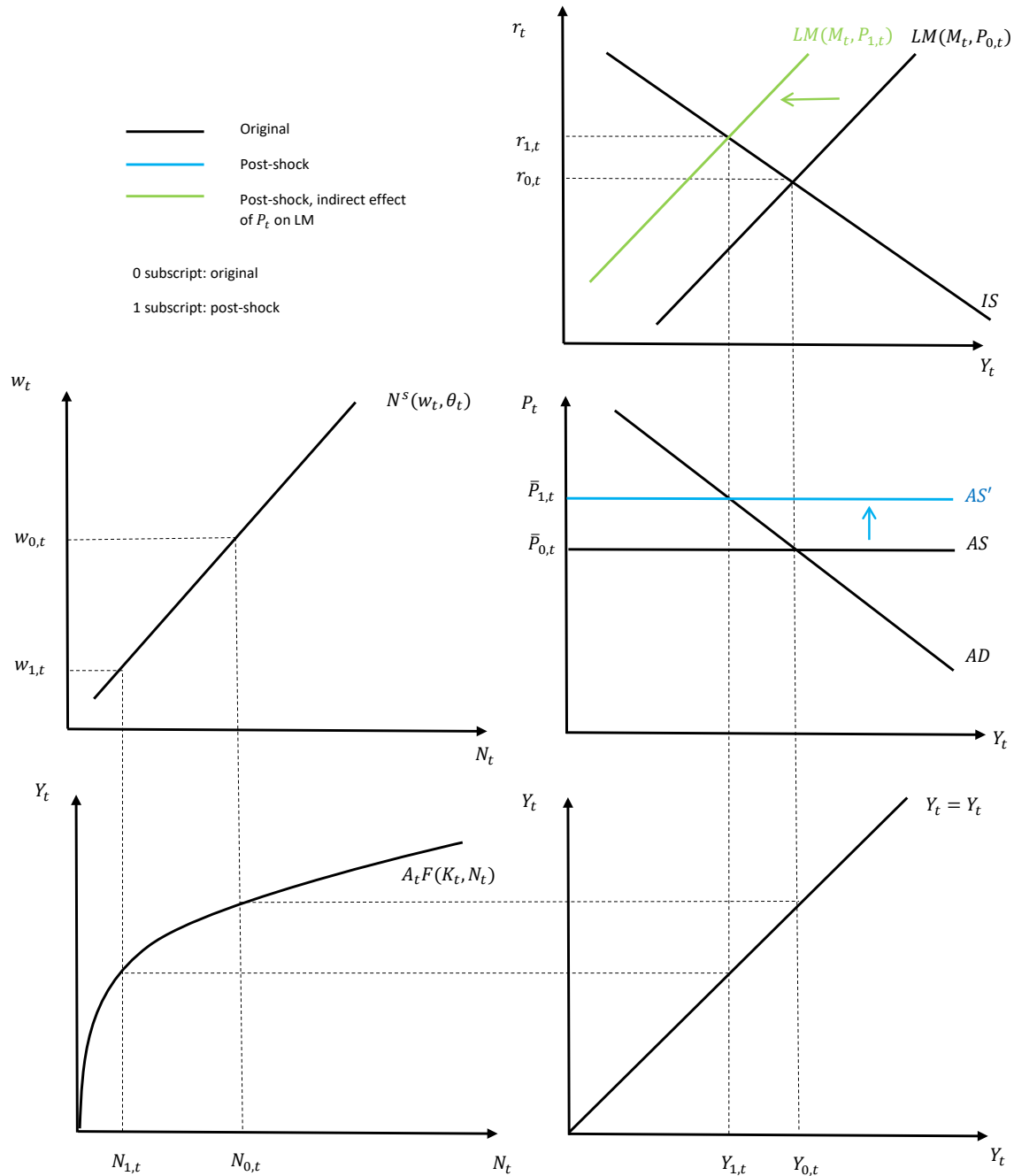

Table 25.2 below summarizes the effects of changes in exogenous variables in the sticky price model on the endogenous variables of the model.

Table 25.2: Qualitative Effects of Exogenous Shocks on Endogenous Variables in the Simple Sticky Price Model

Variable	Exogenous Shock				
	$\uparrow M_t$	\uparrow IS curve	$\uparrow A_t$	$\uparrow \bar{P}_t$	$\uparrow \theta_t$
Y_t	+	+	0	-	0
N_t	+	+	-	-	0
w_t	+	+	-	-	+
r_t	-	+	0	+	0
i_t	-	+	0	+	0
P_t	0	0	0	+	0

25.3 Partial Sticky Price Model

Next we consider the model of partial price stickiness. Eight equations characterize the equilibrium of the economy. They are shown below:

$$C_t = C^d(Y_t - G_t, Y_{t+1} - G_{t+1}, r_t) \quad (25.9)$$

$$N_t = N^s(w_t, \theta_t) \quad (25.10)$$

$$P_t = \bar{P}_t + \gamma(Y_t - Y_t^f) \quad (25.11)$$

$$I_t = I^d(r_t, A_{t+1}, K_t) \quad (25.12)$$

$$Y_t = A_t F(K_t, N_t) \quad (25.13)$$

$$Y_t = C_t + I_t + G_t \quad (25.14)$$

$$M_t = P_t M^d(r_t + \pi_{t+1}^e, Y_t) \quad (25.15)$$

$$r_t = i_t - \pi_{t+1}^e \quad (25.16)$$

These are similar to the simple sticky price model, except that we replace (25.2), which assumes that the aggregate price level is fixed (and hence the AS curve is perfectly horizontal), with (25.10), which allows for an upward-sloping, but non-horizontal, AS curve. The parameter γ measures the degree of price stickiness and captures a few special cases. When $\gamma = 0$, the partial sticky price model reverts to the simple sticky price model. When $\gamma \rightarrow \infty$, the partial sticky price model is equivalent to the neoclassical model. Y_t^f is the equilibrium level of

output if prices were flexible (i.e. if we were in the neoclassical model). It can be found by combining the level of N_t where labor demand (which is not directly relevant for the partial sticky price model equilibrium) intersects labor supply with the production function. To determine Y_t^f (and hence the position of the AS curve), we draw in a hypothetical labor demand curve (in orange) and denote where the neoclassical (vertical) AS curve would be in orange as well. For simplicity, we assume (and will always do so, unless otherwise noted) that the initial equilibrium of the partial sticky price model coincides with the hypothetical neoclassical equilibrium – that is, $P_{0,t} = \bar{P}_{0,t}$, and $Y_{0,t} = Y_{0,t}^f$.

In a way similar (though not as stark) to the simple sticky price model, labor market variables (labor input and the real wage) are determined “after” output. Output is determined by the joint intersection of the AD curve (the position of which is determined by the IS curve) and the AS curve (the position of which is partially exogenously determined by \bar{P}_t – as in the simple sticky price model – and partially determined through Y_t^f – which is itself determined by labor demand and supply as in the neoclassical model). Once output is determined, one figures out what N_t must be to be consistent with that level of output from the production function. Then one determines the real wage by reading off the real wage from the labor supply curve at this level of labor input.

Figure 25.11: Equilibrium in the Partial Sticky Price Model

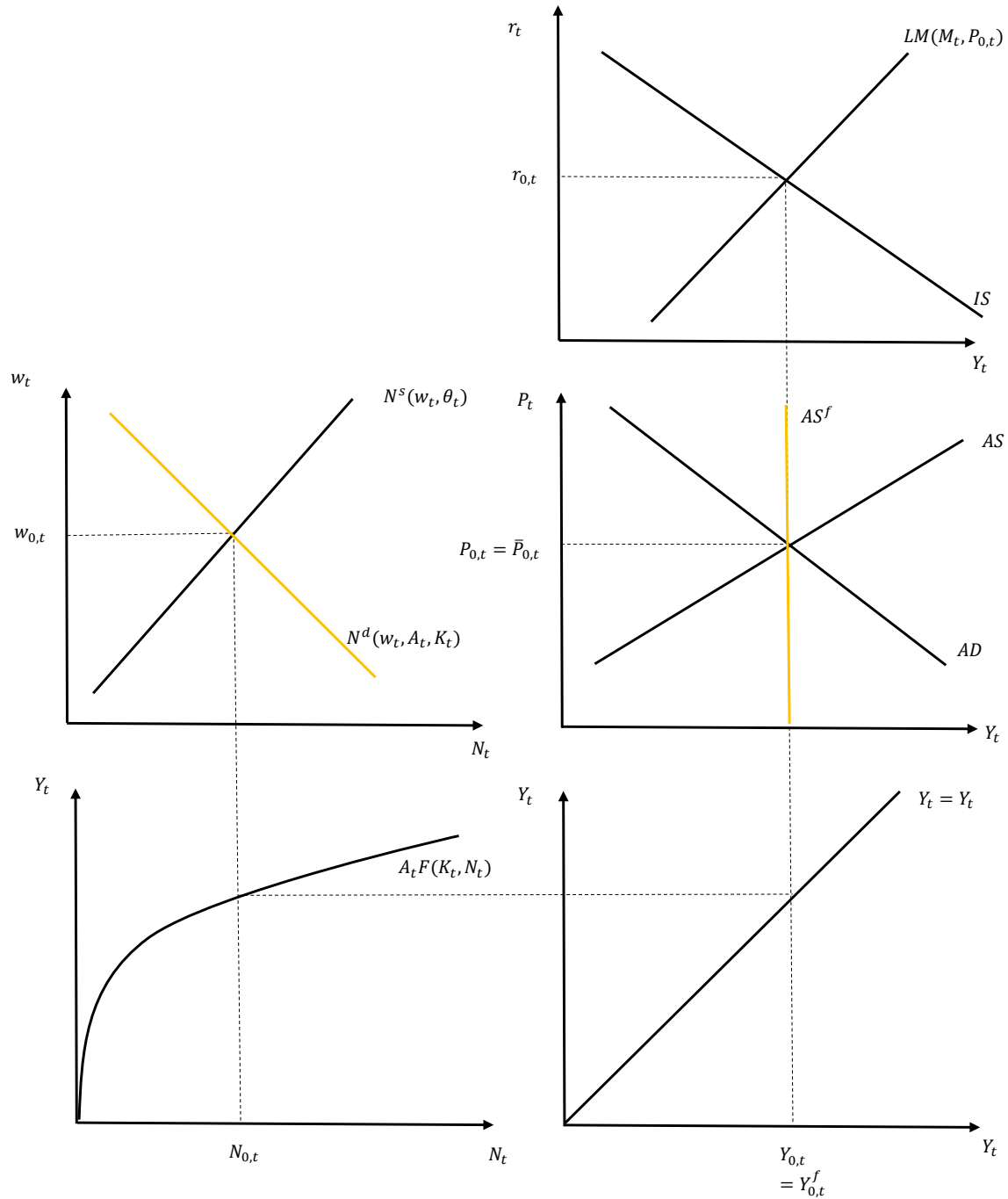

Having presented the model's equilibrium graphically, let us now study how the endogenous variables of the model react to different exogenous shocks. We begin first with an exogenous increase in M_t . The direct effect of this increase (holding the price level fixed) is to shift the LM curve out to the right. This results in a higher level of output where the economy sits on both the IS and LM curves for each possible price level. As a result, the AD curve

shifts out to the right. The new equilibrium price level and output are found where the new AD curve intersects the AS curve. Since the AS curve is upward-sloping, we see that both output and the price level rise. Note that output rises by *less* than it would if the price level were fixed (i.e. the equilibrium change in output is smaller than the horizontal rightward shift of the AD curve). Because the price level increases, there is an indirect effect on the LM curve which partially offsets the direct effect of higher M_t . In particular, the higher P_t causes the LM curve to shift in to the left so that it intersects the IS curve at the level of Y_t where the AD and AS curves intersect. This indirect effect of the price level changing on the position of the LM curve is denoted in green in the figure. As long as the AS curve is not vertical (i.e. $\gamma < \infty$), output still rises and the real interest rate is, on net, lower than before the shock. Once we have determined Y_t , we then turn to labor market variables. Since there has been no shift of the production function but Y_t is higher, N_t must rise. Since labor is determined from the labor supply curve (not the labor demand curve), this necessitates a higher real wage. We can thus conclude that an exogenous increase in M_t results in output, consumption, investment, the real wage, and labor input all rising, while the real interest rate and the price level both fall.

Figure 25.12: Partial Sticky Price: Effect of Increase in M_t

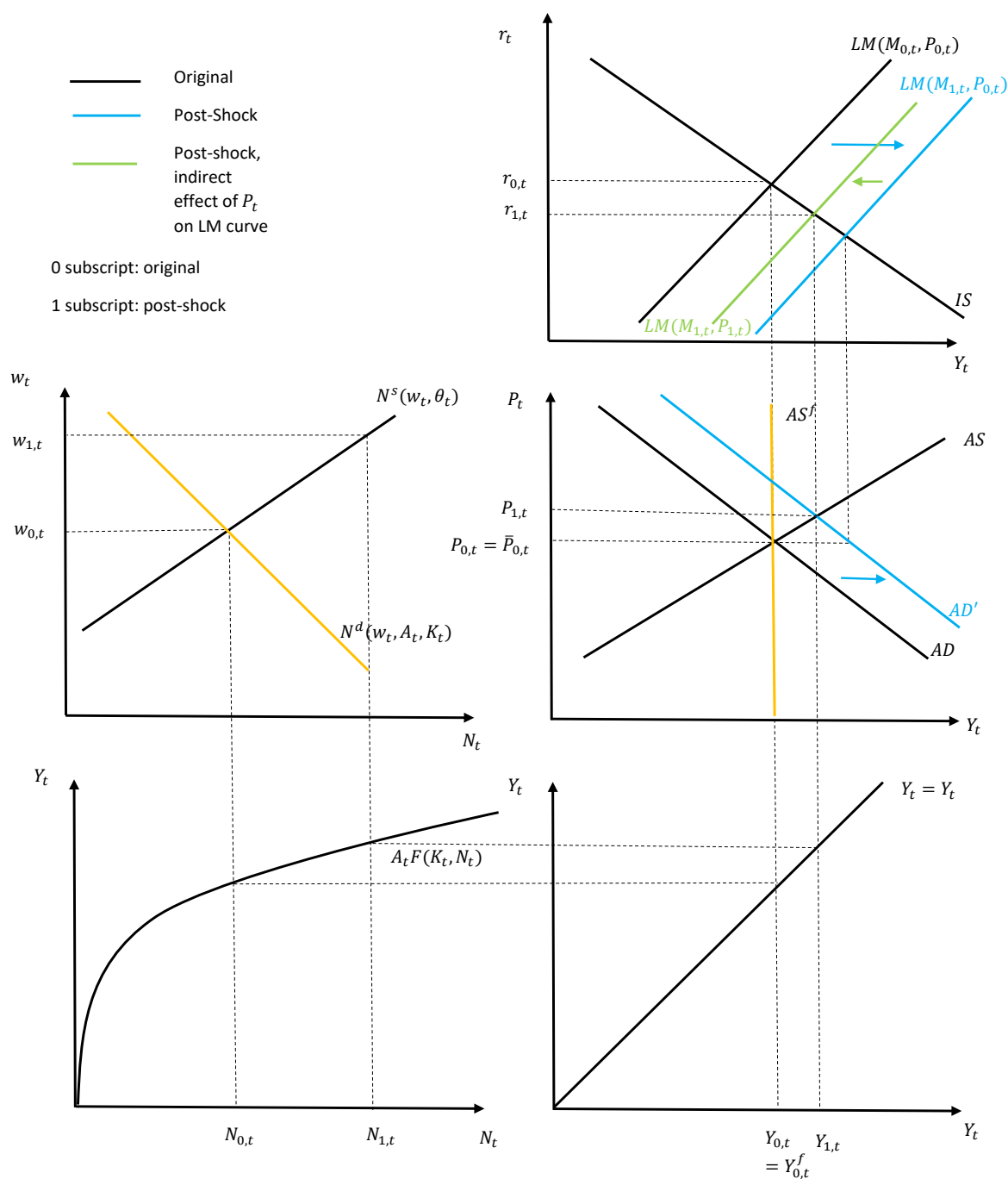

In Figure 25.12, note that the LM curve is *on net* further out to the right than where it started (i.e. the green line lies to the east of the black LM curve). But it is not as far to the east as the blue LM curve (which holds the price level fixed). In thinking about monetary non-neutrality and the three different models, there is a simple intuition. In the neoclassical model, the central bank cannot affect $\frac{M_t}{P_t}$ – any change in M_t is met by a proportional change

in P_t , so that $\frac{M_t}{P_t}$, and hence the LM curve (and hence output and the real interest rate) are not affected. In the partial sticky price model, P_t is fixed, and changes in M_t causes the LM curve to shift, resulting in changes in Y_t and r_t . The partial sticky price model lies *somewhere in between* the simple sticky price model and the neoclassical model. P_t can move, but not as much as in the neoclassical model. Thus, the central bank has some control over $\frac{M_t}{P_t}$ (and hence the position of the LM curve), at least in the short run.

Next consider a shock which shifts the IS curve to the right. This could result from an increase in A_{t+1} , an increase in G_t , or an anticipated decrease in G_{t+1} . The direct effect of the exogenous change is for the IS curve to shift to the right. For a given price level (i.e. moving along a stable LM curve), this results in a higher level of output. This means that the AD curve shifts rightward – i.e. for a given P_t , the Y_t consistent with being on both IS and LM curves is larger. With the AS curve non-horizontal and non-vertical, the price level and output must both rise. The rise in the price level means that output rises by less than the horizontal shift of the AD curve. Similarly to above in the case of an increase in M_t , the higher price level has an indirect effect on the position of the LM curve. In particular, the higher price level results in the LM curve shifting in to the left, although not so much that output is not, on net, higher. We therefore see that the real interest rate rises in equilibrium. We lastly consider labor market variables. Since output is higher and the production function is not directly affected, we can conclude that labor input must be higher. Since labor is determined from the labor supply curve, we therefore conclude that the real wage must rise. We cannot say with certainty what will happen to C_t and I_t in equilibrium without knowing what shock causes the IS curve to shift right.

Figure 25.13: Partial Sticky Price: Effect of Positive IS Shock

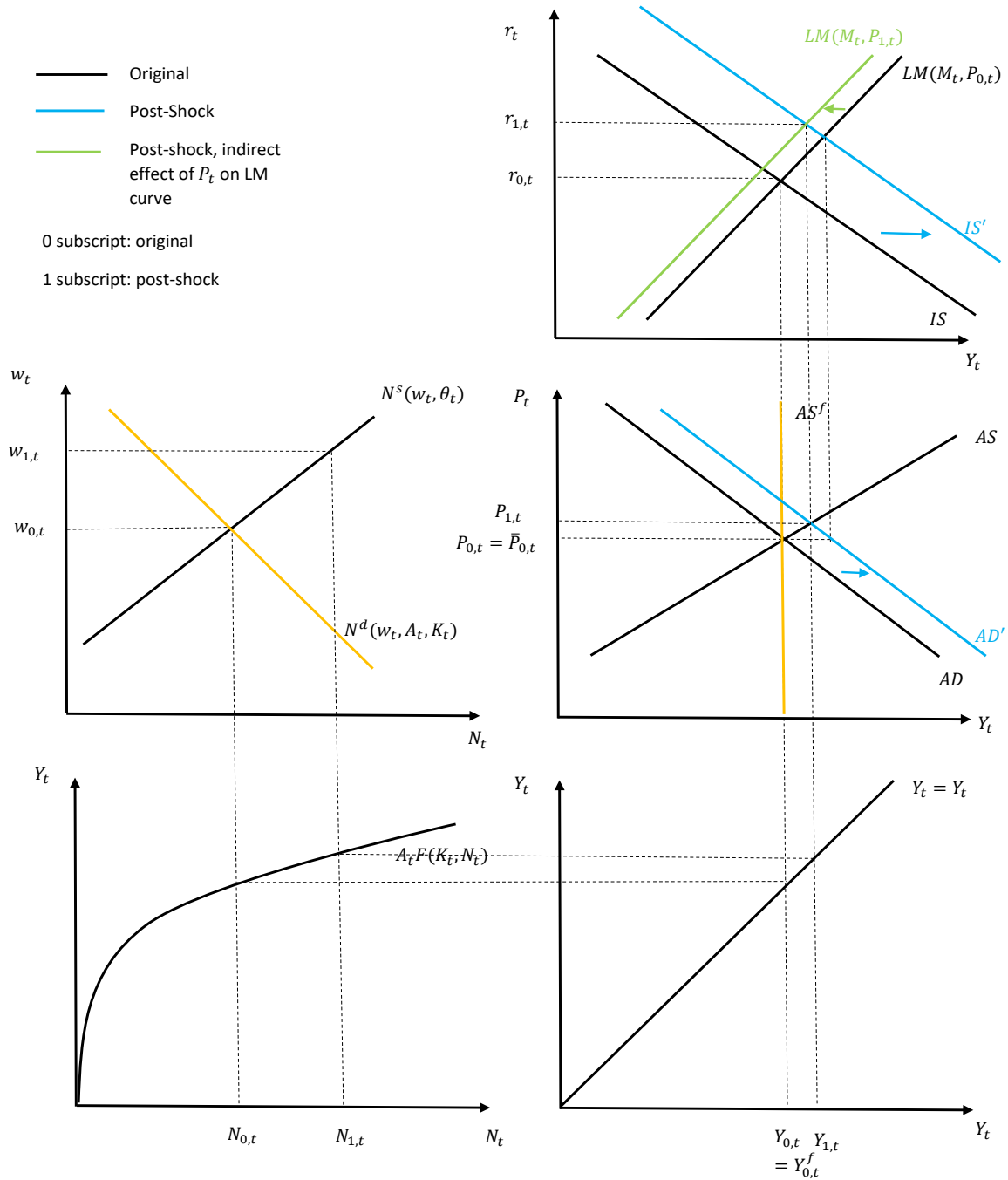

We next turn our attention to how supply side shocks impact the equilibrium of the partial sticky price model. Consider first an increase in A_t . This does not directly impact the IS or LM curves, and hence the AD curve is unaffected. It will affect the position of the AS curve because it will affect Y_t^f . Graphically, we can figure out how Y_t^f is impacted as follows. First, note that an increase in A_t would raise the marginal product of labor and

therefore shift the labor demand curve out to the right. While the labor demand curve is not directly relevant for the equilibrium of the partial sticky price model, it is important to note this when figuring out what happens to Y_t^f . Along a stable labor supply curve, this rightward shift of the labor demand curve would result in a higher level of labor input were prices fully flexible. In addition, the production function itself shifts up (i.e. the economy can produce more output for a given amount of capital and labor). Hence, the flexible price level of output, Y_t^f , increases whenever A_t increases. This increase in Y_t^f would result in the AS curve shifting horizontally to the right by the amount of the increase in Y_t^f . Graphically, we can see this by noting that the upward-sloping AS curve must shift right in such a way where it would intersect the hypothetical flexible price AS curve at \bar{P}_t .

In equilibrium, Y_t will increase but *by less* than the horizontal shift of the AS curve. The price level will fall. The lower price level will have an indirect effect on the position of the LM curve. In particular, the lower price level results in the LM curve shifting to the right in such a way that it intersects the IS curve at the level of Y_t where the AD and AS curves intersect. It is in general not possible to determine the effect of an increase in A_t on N_t (or w_t) in the partial sticky price model. We know from the simple sticky price model that an increase in A_t is associated with decreases in both N_t and w_t , whereas in the neoclassical model an increase in A_t causes both N_t and w_t to increase. In the partial sticky price model the movements in N_t and w_t are somewhere *in between* the simple sticky price model and the neoclassical model, but we cannot say for certain whether N_t and w_t increase or decrease. The picture is drawn where both N_t and w_t decrease.

Figure 25.14: Partial Sticky Price: Effect of Increase in A_t

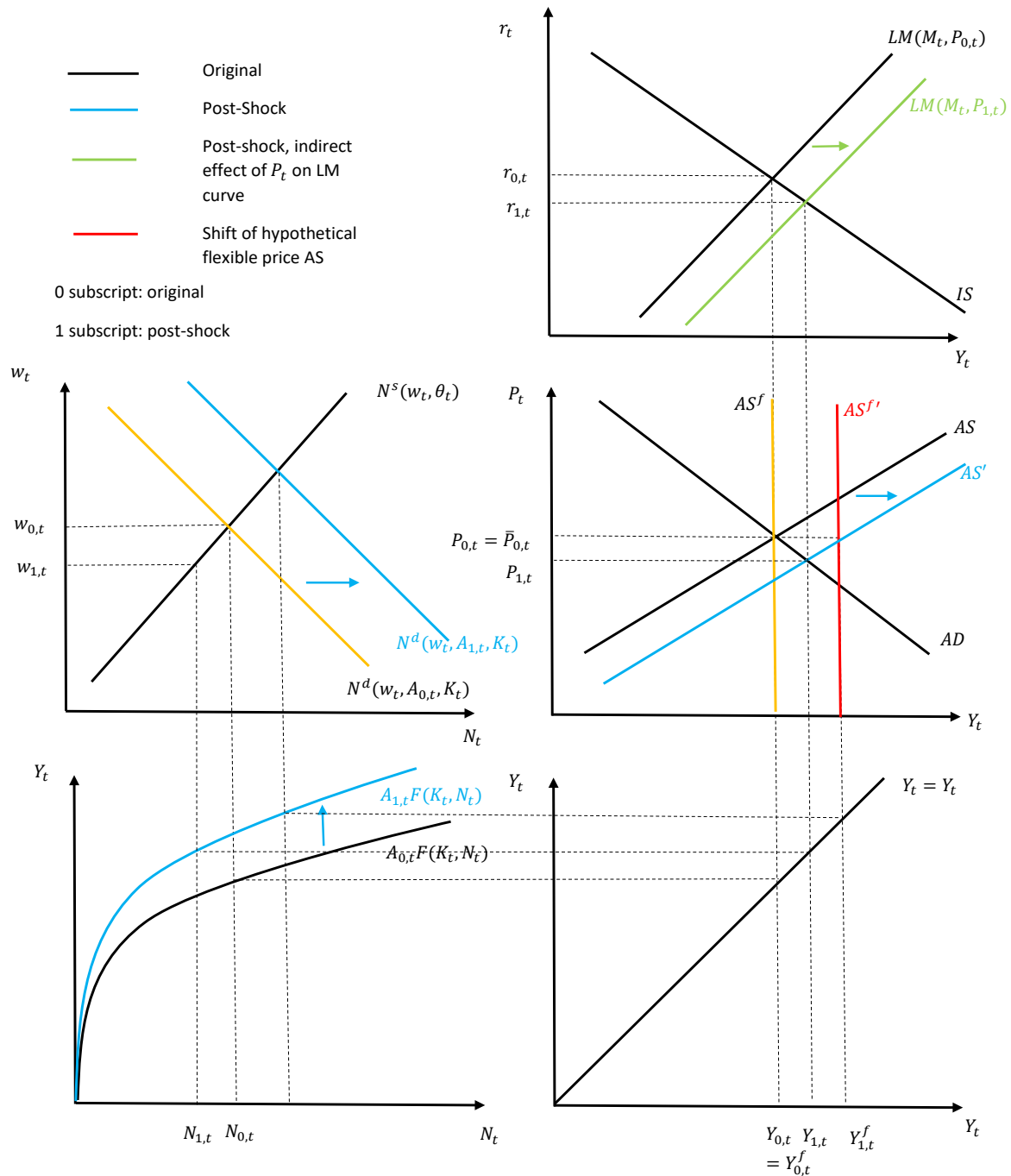

We next consider an exogenous increase in θ_t , a variable which controls the position of the labor supply curve. The position of the labor supply curve is an input to Y_t^f , which determines the position of the AS curve. There is no effect on the IS or LM curves, and hence no shift in the AD curve. The labor supply curve would shift left. Along a stable labor demand curve, this would result in a fall in labor input in the neoclassical model. With no

shift of the production function, Y_t^f would nevertheless fall due to the reduction in labor input. This means that the AS curve will shift horizontally to the left by the amount of the reduction in Y_t^f . This is shown in blue in Figure 25.15. Output will decline and the price level will rise. As in the case of a change in A_t , output changes *by less* than it would if prices were flexible (i.e. the equilibrium change in Y_t is *less* than the horizontal shift of the AS curve). The higher price level results an inward shift of the LM curve, which results in r_t rising. Since r_t rises and Y_t falls, C_t and I_t both fall. The equilibrium level of labor input is found off of the labor supply curve at the equilibrium level of output. Note that this will not, in general, correspond with the point where the labor supply curve intersects the hypothetical demand curve. We see that lower output requires less labor input, and the real wage falls.

Figure 25.15: Partial Sticky Price: Effect of Increase in θ_t

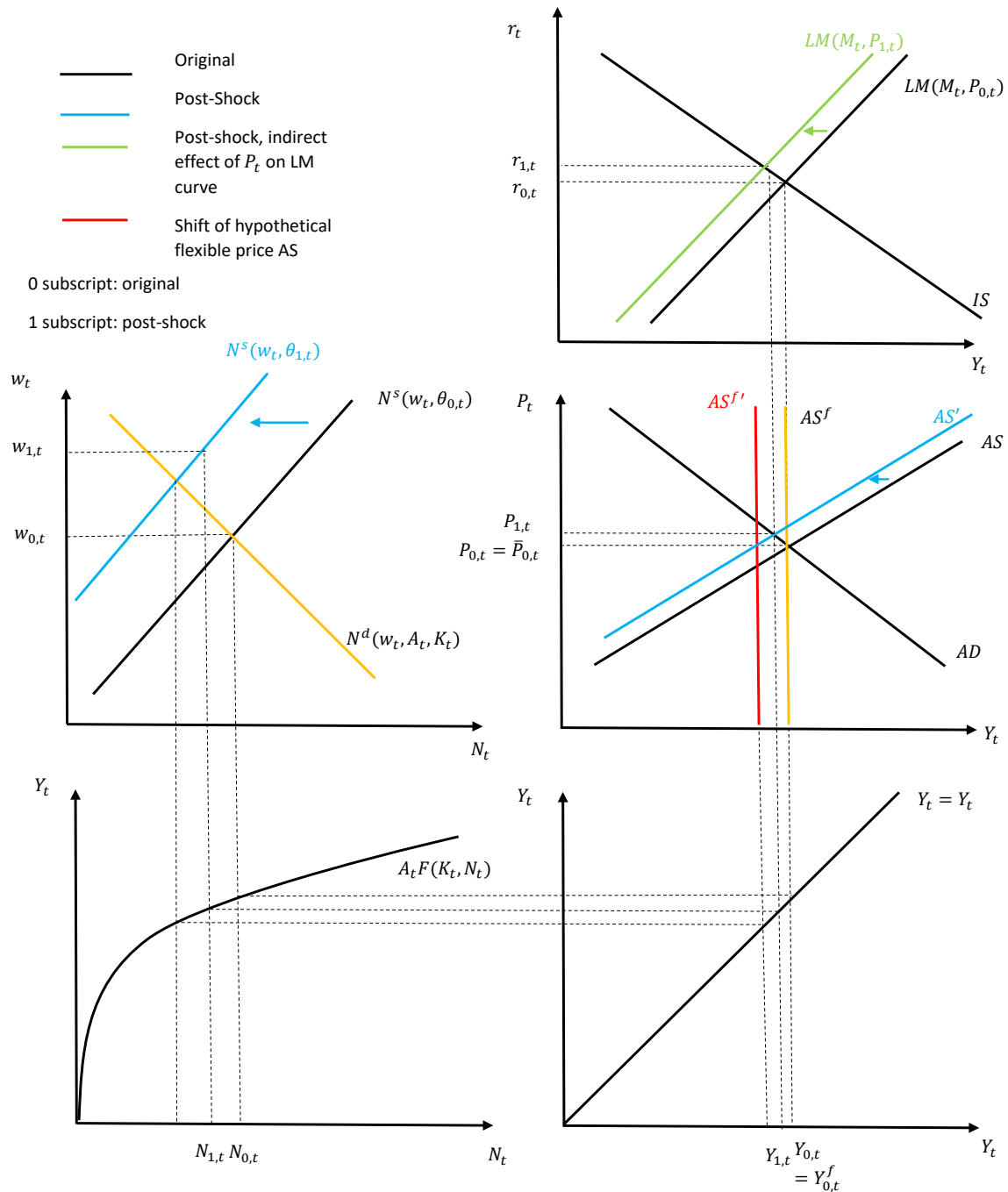

Finally, consider an increase in the exogenous component of the aggregate price level, \bar{P}_t . An increase in this variable causes the AS curve to shift up (with no change in Y_t^f). The price level will rise in equilibrium, but by less than the increase in \bar{P}_t . Output will fall. The higher price level causes the LM curve to shift in, which results in a higher real interest rate. Consumption and investment both fall. Lower output requires lower labor input. Along a

stable labor supply curve, this necessitates a reduction in the real wage. These effects can be seen in Figure 25.16.

Figure 25.16: Partial Sticky Price: Effect of Increase in \bar{P}_t

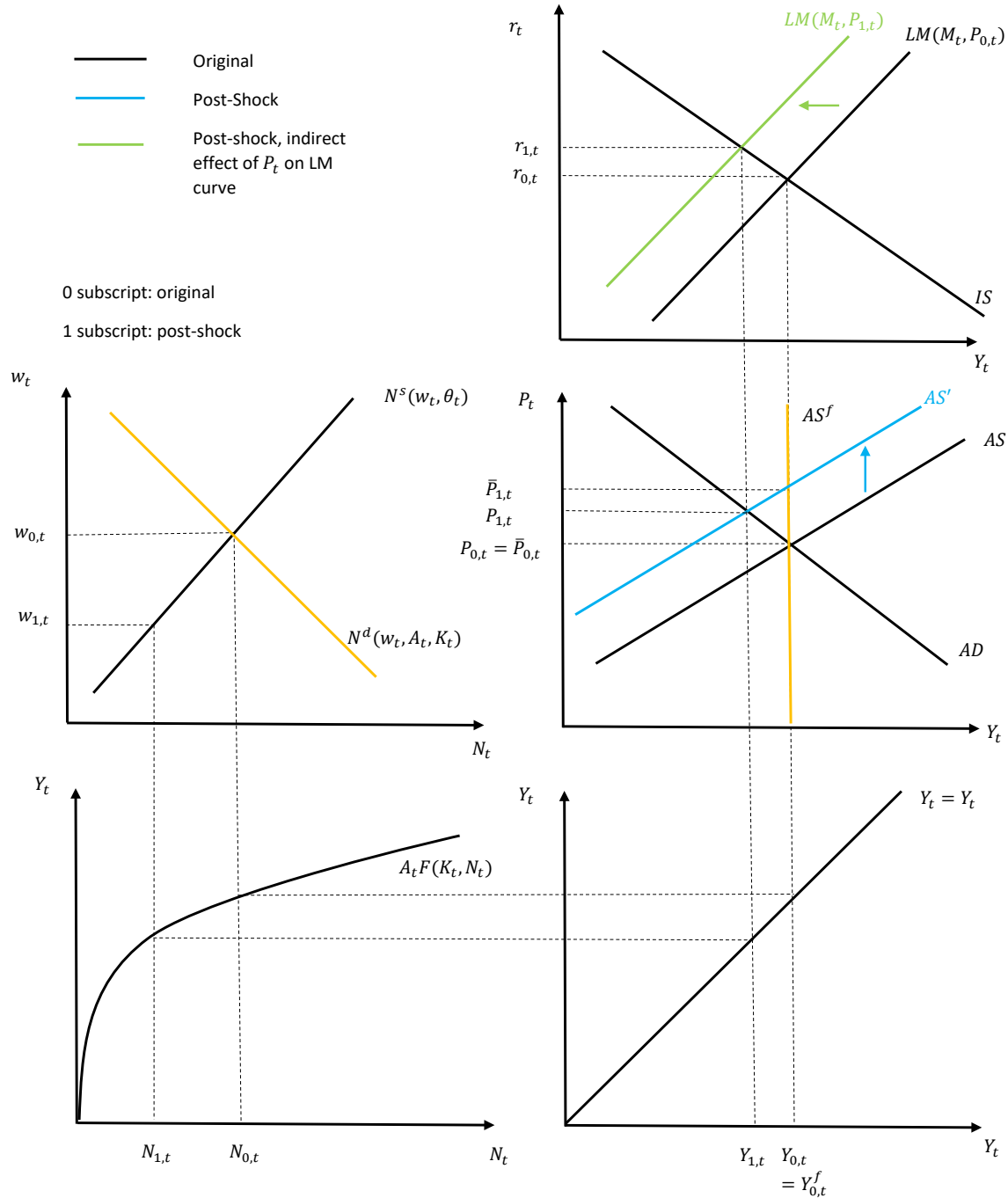

Table 25.3 below summarizes the qualitative effects of changes in the exogenous variables on the endogenous variables in the partial sticky price model. A useful way to study this table is to note that the equilibrium effects here are *in between* the effects in the simply sticky

price model (Table 25.2) and the neoclassical model (Table 25.1). In other words, whereas in the neoclassical model Y_t is unaffected after a positive IS shock but Y_t rises in the simple sticky price model, in the partial sticky price model Y_t rises, but not by as much as in the simple sticky price model.

Table 25.3: Qualitative Effects of Exogenous Shocks on Endogenous Variables in the Partial Sticky Price Model

Variable	Exogenous Shock				
	$\uparrow M_t$	\uparrow IS curve	$\uparrow A_t$	$\uparrow \bar{P}_t$	$\uparrow \theta_t$
Y_t	+	+	+	-	-
N_t	+	+	?	-	-
w_t	+	+	?	-	+
r_t	-	+	-	+	+
i_t	-	+	-	+	+
P_t	+	+	-	+	+

25.4 Comparing the New Keynesian Model to the Neoclassical Model

In this section, we briefly conclude the chapter by comparing the responses of endogenous variables in the two variants of the New Keynesian model to the neoclassical model. We reach the following general conclusion. Relative to the neoclassical model, in the New Keynesian model output “under-reacts” to supply shocks and “over-reacts” to demand shocks. Put a little differently, nominal rigidity makes demand shocks have *bigger* effects on output and supply shocks *smaller* effects compared to a world with no price stickiness.

This point is trivial to see for changes in exogenous variables which affect the position of the AD curve. When the AS curve is vertical as in the Neoclassical model, output does not react. If the AS curve is non-vertical, either because of complete or partial price stickiness, output will react, and will react more the flatter is the AS curve. A corollary to this result is that output will react more to demand shocks in the simple sticky price model (perfectly horizontal AS curve) than in the partial sticky price (upward-sloping but non-horizontal AS curve).

What about supply shocks (exogenous changes in A_t , θ_t , or \bar{P}_t)? We can see that output reacts *less* to changes in A_t or θ_t than it would in the neoclassical model. We shall refer to

A_t and θ_t as *real supply shocks* in the sense that these are exogenous variables which would impact production in a world without nominal rigidities. In the simple sticky price model this result is trivial since output does not react at all to these shocks, but it is also true (albeit to a lesser extent) in the partial sticky price model. This is because the upward-sloping AS curve shifts horizontally in the same magnitude as it would in the neoclassical model, but because the AS curve is non-vertical, in equilibrium output will react less than it would if the price level were flexible. \bar{P}_t is not relevant for output in the neoclassical model, but causes output to change in a model with some degree of nominal rigidity. We shall therefore call \bar{P}_t a *nominal supply shock* as it would influence the nominal value of production (i.e. dollar value) in a world bereft of nominal rigidity but not the real value of production. Sometimes \bar{P}_t is also called a *cost-push shock*.

Table 25.4 compares the magnitudes of changes in selected endogenous variables to different exogenous shocks in both variants of the sticky price model (simple sticky price model, or SSP, and partial sticky price model, or PSP) to the neoclassical model (labeled NEO in the table). The inequality signs reference the magnitude of the change in a particular variable (i.e. if a variable rises by more in the SSP model compared to the PSP model, we use a “>” indicator; likewise, if a variable falls by more in the SSP model compared to the PSP model, we also use a “>” indicator since the *change* is bigger). We split shocks into four categories – *nominal demand* (shocks to the LM curve, so changes in M_t or π_{t+1}^e); *real demand* (shocks to the IS curve, so A_{t+1} , G_t , or G_{t+1}); *real supply* (things which would change Y_t^f , or equivalently shift the Y^s curve previously introduced, so changes in A_t or θ_t); and *nominal supply* (change in \bar{P}_t). The table considers *increases* in these different categories.

Table 25.4: Comparing the Sticky Price and Neoclassical Models

Variable	Exogenous Shock			
	↑ Nominal Demand	↑ Real Demand	↑ Real Supply	↑ Nominal Supply
Change in Y_t	SSP > PSP > NEO	SSP > PSP > NEO	SSP < SP < NEO	SSP > SP > NEO
Change in N_t	SSP > PSP > NEO	SSP > PSP > NEO	SSP < SP < NEO	SSP > SP > NEO
Change in r_t	SSP > PSP > NEO	SSP < PSP < NEO	SSP < SP < NEO	SSP > SP > NEO
Change in P_t	SSP < PSP < NEO	SSP < PSP < NEO	SSP < SP < NEO	SSP < SP < NEO

25.5 Summary

- In contrast to the Neoclassical model, demand shocks affect output in New Keynesian models. Also, real variables are simultaneously determined with nominal variables so a change in the money supply has real effects.
- The AS curve is perfectly flat in the simple sticky price economy and upward-sloping but non-vertical in the partial sticky price model. This means that output is either solely determined by aggregate demand (simple sticky price model) or jointly determined by demand and supply (partial sticky price model). In the neoclassical model output is solely determined by aggregate supply.
- In either variant of the New Keynesian model, output *over-reacts* to demand shocks (either nominal or real) compared to the neoclassical model. It *under-reacts* to real supply shocks (i.e. changes in A_t or θ_t) and *over-reacts* to nominal supply shocks (i.e. changes in \bar{P}_t).

Questions for Review

1. What does it mean to say that output in the New Keynesian model under reacts to real supply shocks?
2. Which way does the real wage move after an IS shock in the sticky-price model? Can the a sticky price model generate a procyclical real wage if it is predominantly driven by demand shocks?
3. What is a real-world example of a change in \bar{P}_t ?

Exercises

1. **Deep thoughts about the AD curve** The equations characterizing the demand side in the New Keynesian (and Neoclassical for that matter) are

$$C_t = C^d(Y_t - G_t, Y_{t+1} - G_{t+1}, r_t)$$

$$I_t = I^d(r_t, A_{t+1}, K_t)$$

$$Y_t = C_t + I_t + G_t$$

$$M_t = P_t M^d(r_t + \pi_{t+1}^e, Y_t)$$

- (a) Which equations summarize the IS curve?

- (b) Under our standard assumptions, how are consumption and investment affected by changes in the interest rate?
 - (c) Suppose consumption and investment are very sensitive to changes in the interest rate. How will this affect the slope of the IS curve? What is the economic intuition? Derive the AD curve in this case.
 - (d) Now suppose neither consumption nor investment are affected by changes to the interest rate. Show how will this affect the slope of the IS curve and explain the economic intuition. Derive the AD curve in this case and discuss how the slope is different than in part b.
2. Graphically analyze the effects of an increase in θ_t in the Neoclassical, simple sticky price, and partial sticky price model. When possible, compare the magnitudes of the changes of each endogenous variable.
 3. Suppose that we have a simple sticky price New Keynesian model. Suppose that the consumption, investment, and money demand functions are given by:

$$C_t = c_1(Y_t - G_t) + c_2(Y_{t+1} - G_{t+1}) - c_3r_t$$

$$I_t = -b_1r_t + b_2A_{t+1} - b_3K_t$$

$$M_t = P_t - m_1(r_t + \pi_{t+1}^e) + m_2Y_t$$

Here, c_1 , c_2 , and c_3 are positive parameters, as are b_1 , b_2 , and b_3 and m_1 and m_2 . Government spending, G_t , is exogenous. The other equations of the model are standard and we need not give exact functional forms.

- (a) Derive an algebraic expression for the AD curve.
 - (b) In the simple sticky price model, the AS curve is given by $P_t = \bar{P}_t$, which is exogenous. Use this to derive an expression for the equilibrium level of output.
4. Suppose that agents come to expect a higher inflation rate which in the model is represented by an increase in the exogenous variable π_{t+1}^e .
 - (a) Graphically show how this affects the endogenous variables of the in the simple sticky-price model. Discuss how consumption, investment, the real wage, and the labor input change.
 - (b) Graphically show how this affects the endogenous variables of the in the partial sticky-price model. Discuss how consumption, investment, the

real wage, and the labor input change.

- (c) Graphically show how this affects the endogenous variables of the in the Neoclassical model. Discuss how consumption, investment, the real wage, and the labor input change.
5. Suppose that we have a partial sticky price New Keynesian model. Suppose that the economy is hit with an increase in A_{t+1} . Suppose that the central bank wants to adjust the money supply in such a way that the real wage does not change in response to this shock. How must the central bank adjust policy in response to the increase in A_{t+1} in order to achieve this end? How does output react to the change in A_{t+1} if the central bank follows such a policy? How does this change in Y_t compare to a world in which the money supply is exogenous (i.e. does not react to the increase in A_{t+1})?

Chapter 26

Dynamics in the New Keynesian Model: Transition from Short Run to Medium Run

In the New Keynesian model it is assumed that the price level is “sticky” in the short run. In Chapter 25, we analyzed how this stickiness impacts the shape of the aggregate supply curve, and how nominal stickiness influences the reaction of endogenous variables to changes in exogenous shocks.

In this Chapter, we examine how the economy ought to transition from the “short run” to the “medium run.” From the firm’s perspective, the optimal level of output to produce is Y_t^f , the neoclassical level of output. $Y_t \neq Y_t^f$ means that the firm is off its labor demand curve and is hence not maximizing profit. From the AS curve, $Y_t \neq Y_t^f$ means that $P_t \neq \bar{P}_t$. Since the firm desires to produce Y_t^f but cannot because $\bar{P}_t \neq P_t$, when given the opportunity the firm will choose to adjust \bar{P}_t . The firm will adjust \bar{P}_t by an amount necessary to shift the AS curve such that it intersects the AD curve at Y_t^f . Effectively, any output gap (i.e. $Y_t \neq Y_t^f$) will put pressure on the exogenous component of the price level, \bar{P}_t , to change. This change will cause the AS curve to shift so that the neoclassical equilibrium is eventually restored.

Formally, we will think about dynamics in the model as follows. The present period is denoted t . Think about period t as lasting three years (this is arbitrary and one could entertain different lengths of the period). Denote the exogenous component of the price level as \bar{P}_t^{sr} , where the superscript sr stands for “short run.” This is predetermined and fixed within period t . If the AD and AS curves do not intersect at \bar{P}_t^{sr} , then the firm will be producing more or less than it finds optimal. After, say, two years, the firm can adjust the exogenous component of the price level to \bar{P}_t^{mr} , where the mr superscript stands for “medium-run.” The firm will change \bar{P}_t in such a way that the AD and AS curves will intersect at the hypothetical neoclassical equilibrium.

We will refer to this process as the economy transitioning from the “short run” (up to two years) to the “medium run” (the third year of the period, t). If the economy finds itself away from the neoclassical equilibrium in the short run, \bar{P}_t will adjust, the AS will shift, and by the third year the equilibrium of the economy will coincide with the hypothetical neoclassical equilibrium. In other words, deviations from the neoclassical equilibrium are only *temporary*

phenomena which arise because of imperfect price flexibility in the short run. In this chapter we will use the following notation – a superscript sr denotes “short run” and a superscript mr denotes “medium run.” We use superscripts to denote this difference because we are treating both the short run and the medium run as occurring *within* period t .

The next two sections work this analysis out in detail and illustrate it in more depth for both the simple and partial sticky price models. We then use the insights from this analysis to talk about the Phillips Curve, anticipated versus unanticipated changes in monetary policy, and the possibility of “costless disinflation.”

26.1 Simple Sticky Price Model

We begin with the simple sticky price model, in which the price level is completely exogenous in the short run and the AS curve is perfectly horizontal. The basic insights will be similar, though somewhat more complicated, in the partial sticky price model to follow.

26.1.1 A Non-Optimal Short Run Equilibrium

Suppose that the initial equilibrium (denoted by 0 subscripts on the relevant endogenous variables with sr superscripts) is such that output is less than it would in the neoclassical model. Such a situation is depicted in Figure 26.1 below. The dark lines show the relevant curves corresponding to the sticky price model, while the orange lines show hypothetical supply-side curves if the price level were flexible.

Figure 26.1: Sticky Price Model: $Y_{0,t}^{sr} < Y_{0,t}^f$

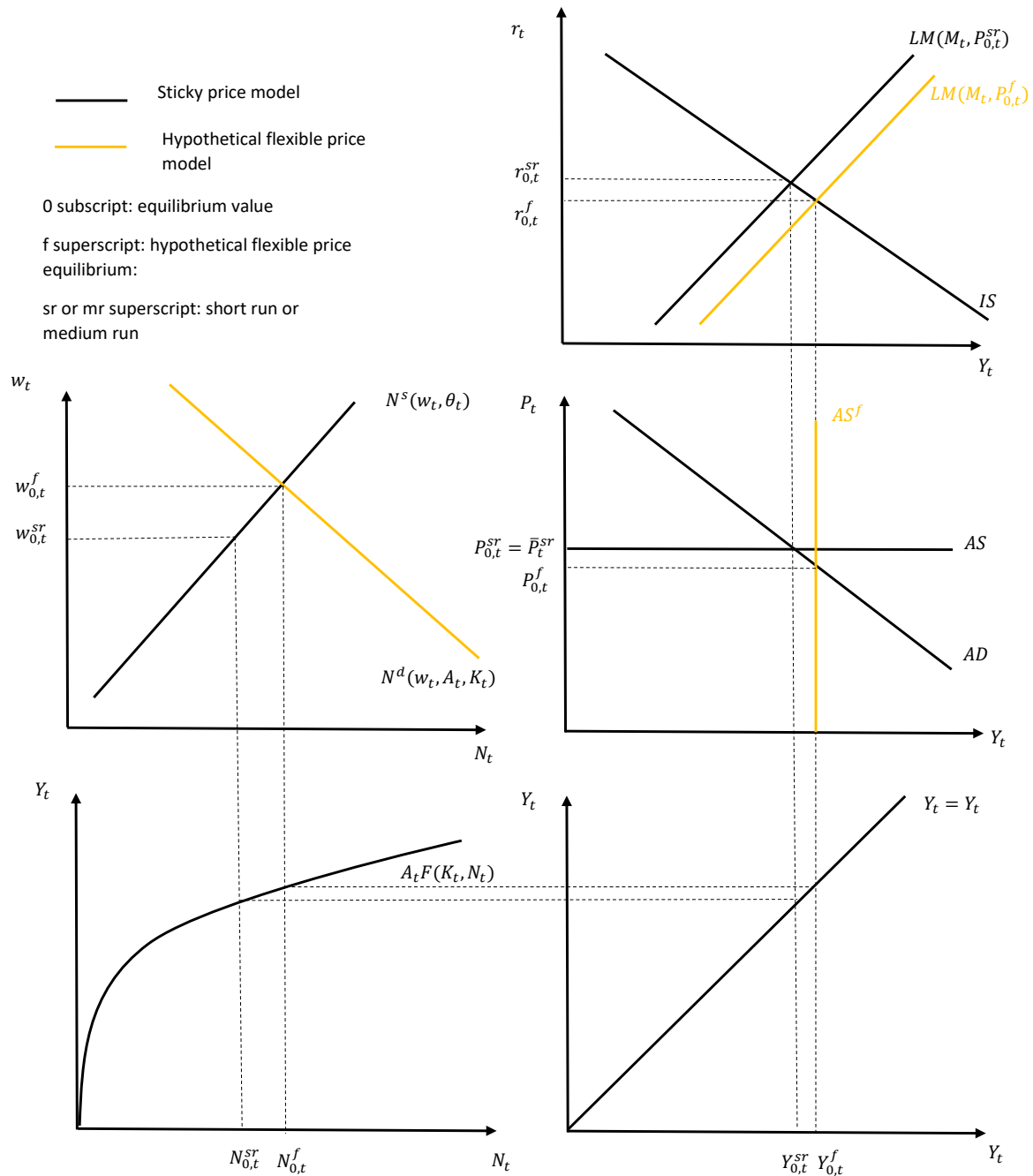
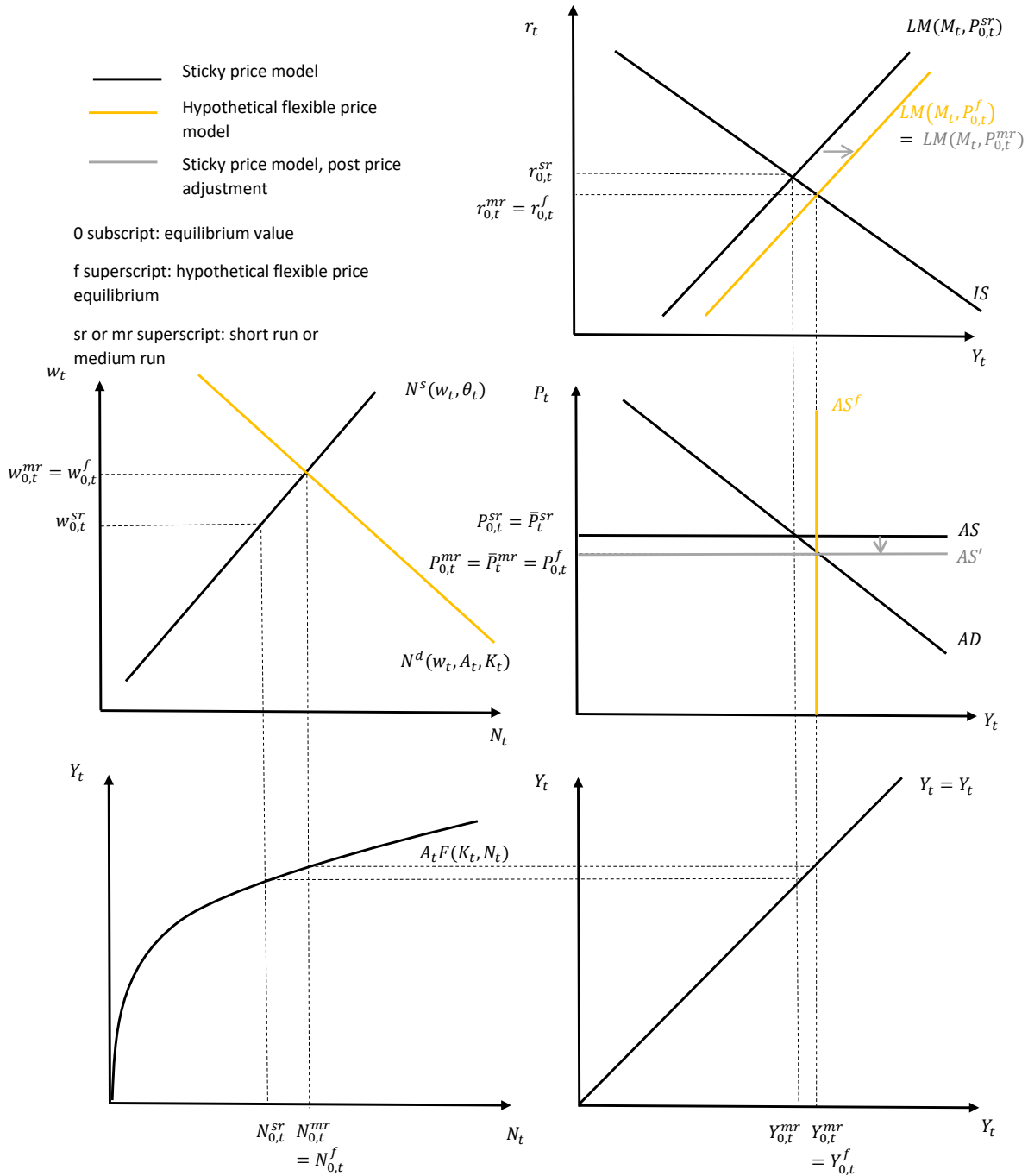

Figure 26.1 has been drawn such that $Y_{0,t}^{sr} < Y_{0,t}^f$, where variables with a f superscript denote hypothetical equilibrium values if the price level were not sticky. In this situation, we have $N_{0,t}^{sr} < N_{0,t}^f$ – the firm would like to hire more labor than it currently is. What is preventing it from doing so is that \bar{P}_t^{sr} is *higher* than it would need to be to implement the neoclassical equilibrium, which is denoted in the graph as $P_{0,t}^f$.

Figure 26.2 plots what ought to happen as the economy transitions from short run to medium run when the economy finds itself in an equilibrium like that depicted in Figure 26.1. The firm will lower its price to \bar{P}_t^{mr} . This is depicted with a gray line showing the AS curve shifting down to AS'. We denote the new equilibrium after price adjustment with a *mr* superscript. The new equilibrium level of output corresponds with the hypothetical neoclassical equilibrium level of output if prices were flexible (i.e. the AS and AD curves now intersects at the hypothetical neoclassical AS curve). The higher level of output means that employment and the real wage rise (to the level consistent with the intersection of labor demand and supply). The lower price level causes the LM curve to shift out in such a way as to intersect the IS curve at $Y_{0,t}^{mr}$, resulting in a lower real interest rate.

Figure 26.2: Sticky Price Model: $Y_{0,t}^{sr} < Y_{0,t}^f$, Short Run to Medium Run Price Adjustment



26.1.2 Dynamic Responses to Shocks

Now suppose that initially the short run equilibrium corresponds with the neoclassical, flexible price equilibrium. Denote this initial equilibrium with a 0 subscript. In this subsection we will consider how different exogenous shocks affect the endogenous variables of the economy

in both the short run and the medium run. For these exercises, we use solid black lines to denote the curves corresponding to the original sticky price equilibrium, and solid orange lines to denote the supply-side curves corresponding with the original hypothetical flexible price equilibrium. Blue lines depict how the curves shift in response to a change in an exogenous variable in the sticky price model, while red lines depict how the supply-side curves in the hypothetical flexible price model would shift. The gray lines denote how the sticky price model reacts *in the medium run* after price adjustment has had a chance to take place. We use 0 subscripts to denote the original equilibrium and 1 subscripts to denote the equilibrium after the change in the relevant exogenous variable. *sr* superscripts denote the short run equilibrium (either before or after the shock), while *mr* superscripts denote the equilibrium after price adjustment has had a chance to take place.

Figure 26.3 considers the case of an exogenous increase in the money supply. Holding the price level fixed, there is a rightward shift of the LM curve, which results in a rightward shift of the AD curve (shown in blue). With a horizontal AS curve, this results in an increase in output and a lower real interest rate in the short run, which are labeled $Y_{1,t}^{sr}$ and $r_{1,t}^{sr}$, respectively. To support the higher level of output, labor input must rise, to $N_{1,t}^{sr}$. This is supported by an increase in the real wage to $w_{1,t}^{sr}$. Since a change in M_t has no effect on Y_t^f , the short run equilibrium features a positive output gap. The firm is producing more than it would like. After a couple of years, the firm will adjust its price to \bar{P}_t^{mr} . This adjustment will be such that the new AS curve (shown in gray) intersects the new AD curve at the original level of output. The increase in the price level causes the LM curve to shift back in to where it started. Labor input and the real wage are unaffected in the medium run relative to their pre-shock values, so $w_{1,t}^{mr} = w_{0,t}^{sr}$ and $N_{1,t}^{mr} = N_{0,t}^{sr}$.

Figure 26.3: Simple Sticky Price Model: Increase in M_t , Short Run to Medium Run

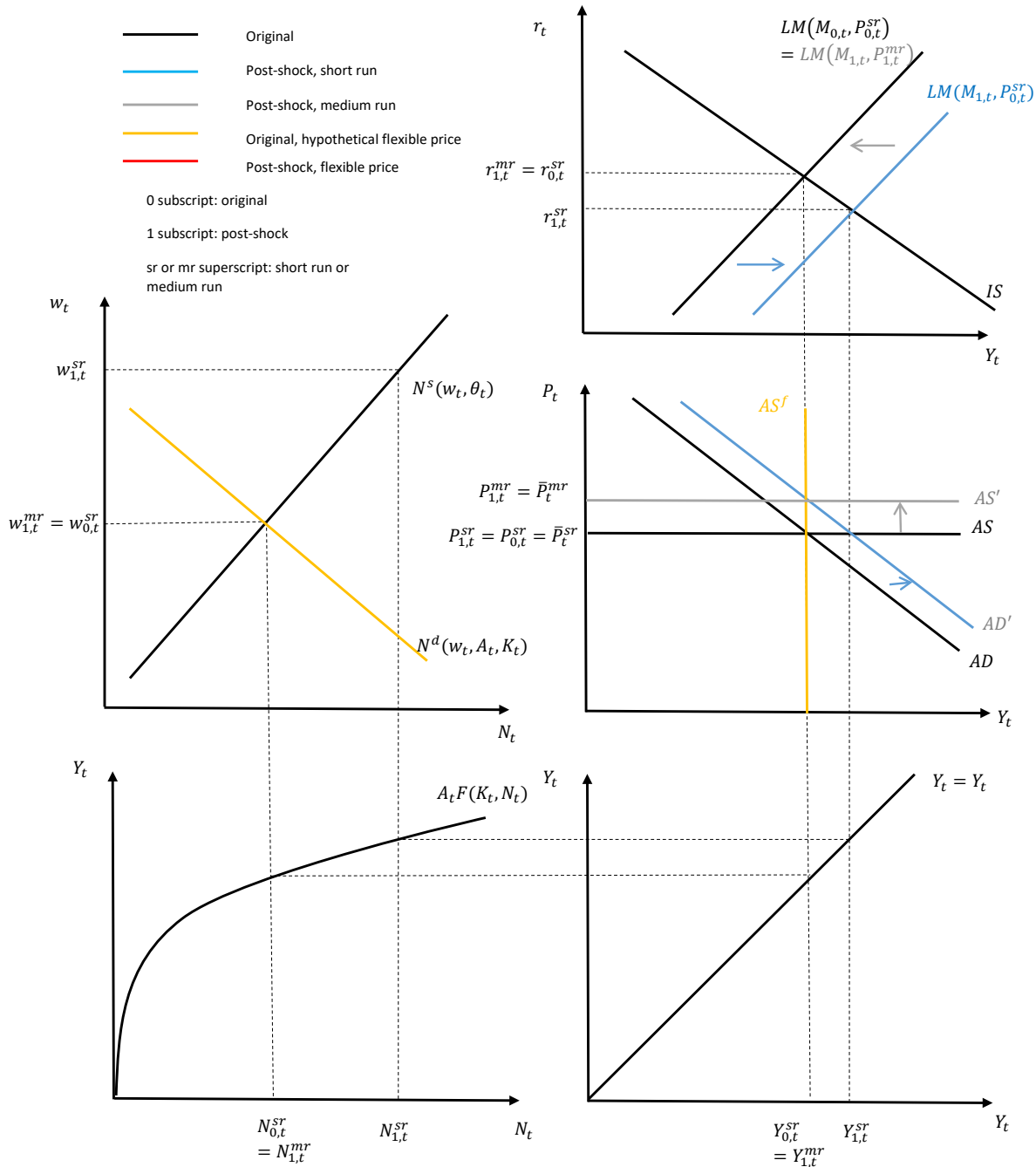

What we see in Figure 26.3 is that an increase in the money supply *temporarily* results in an increase in output and a reduction in the real interest rate. Once the firm is able to adjust its price, the only effect of the increase in M_t is a higher price level (i.e. the same as in the neoclassical model). This is made clear in Figure 26.4. Here we plot responses of variables to a shock over period t , where we have split the period into three different time periods (years

1, 2, and 3). For years 1 and 2, \bar{P}_t^{sr} is fixed. In year 3, the exogenous component of the price level adjusts to \bar{P}_t^{mr} so as to restore the neoclassical equilibrium. The upper left panel simply plots what happens to M_t , which is exogenously given. In the upper right panel, we see that output jumps up when M_t increases and remains high for two years before returning to its pre-shock value. The price level, plotted in the lower left portion, does not change in the short run in the simply sticky price model by construction. It only jumps up in year 3. The real interest rate response is the mirror image of the output response – it temporarily falls for years 1 and 2 before returning to its pre-shock value in year 3.

Figure 26.4: Short Run and Medium Responses: Increase in M_t

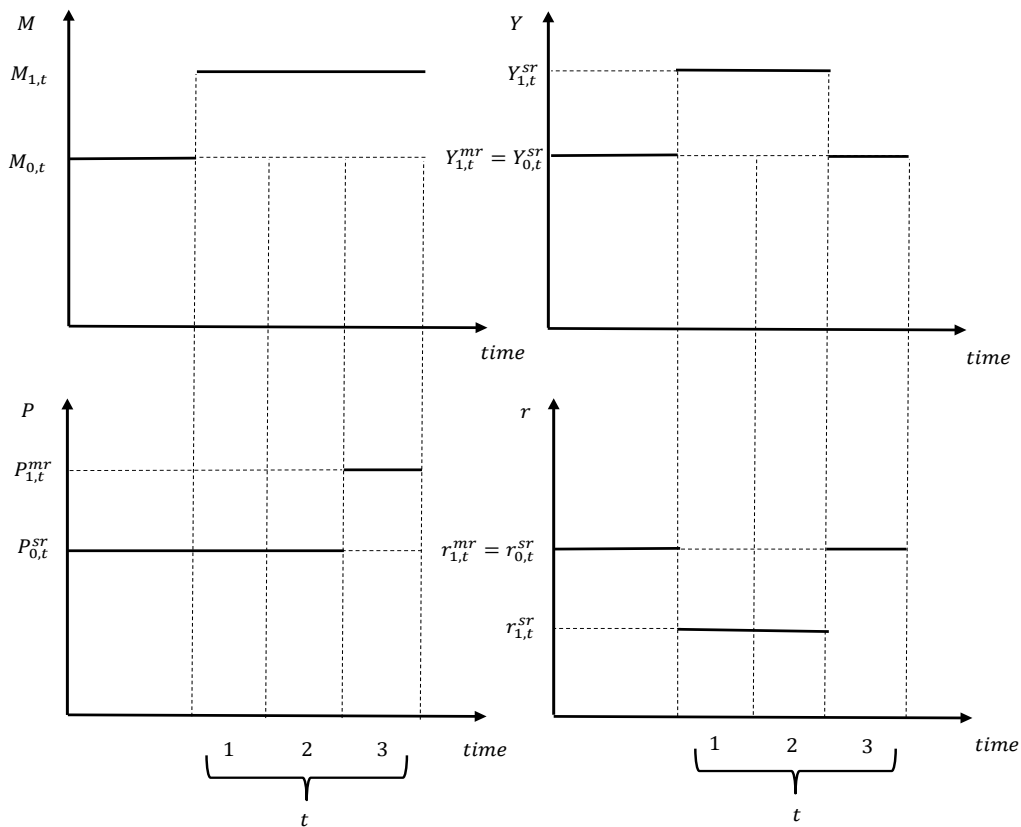

Next, consider the effects of a positive IS shock (either an increase in A_{t+1} or G_t , or a decrease in G_{t+1}). This results in the IS curve shifting to the right, which results in a rightward shift of the AD curve. With a horizontal AS curve, this results in an increase in output. The real interest rate is higher. To support the higher level of output, labor input must increase, and so too must the real wage to be consistent with the labor supply curve. These effects are shown in Figure 26.5.

Figure 26.5: Simple Sticky Price Model: Positive IS Shock, Short Run to Medium Run

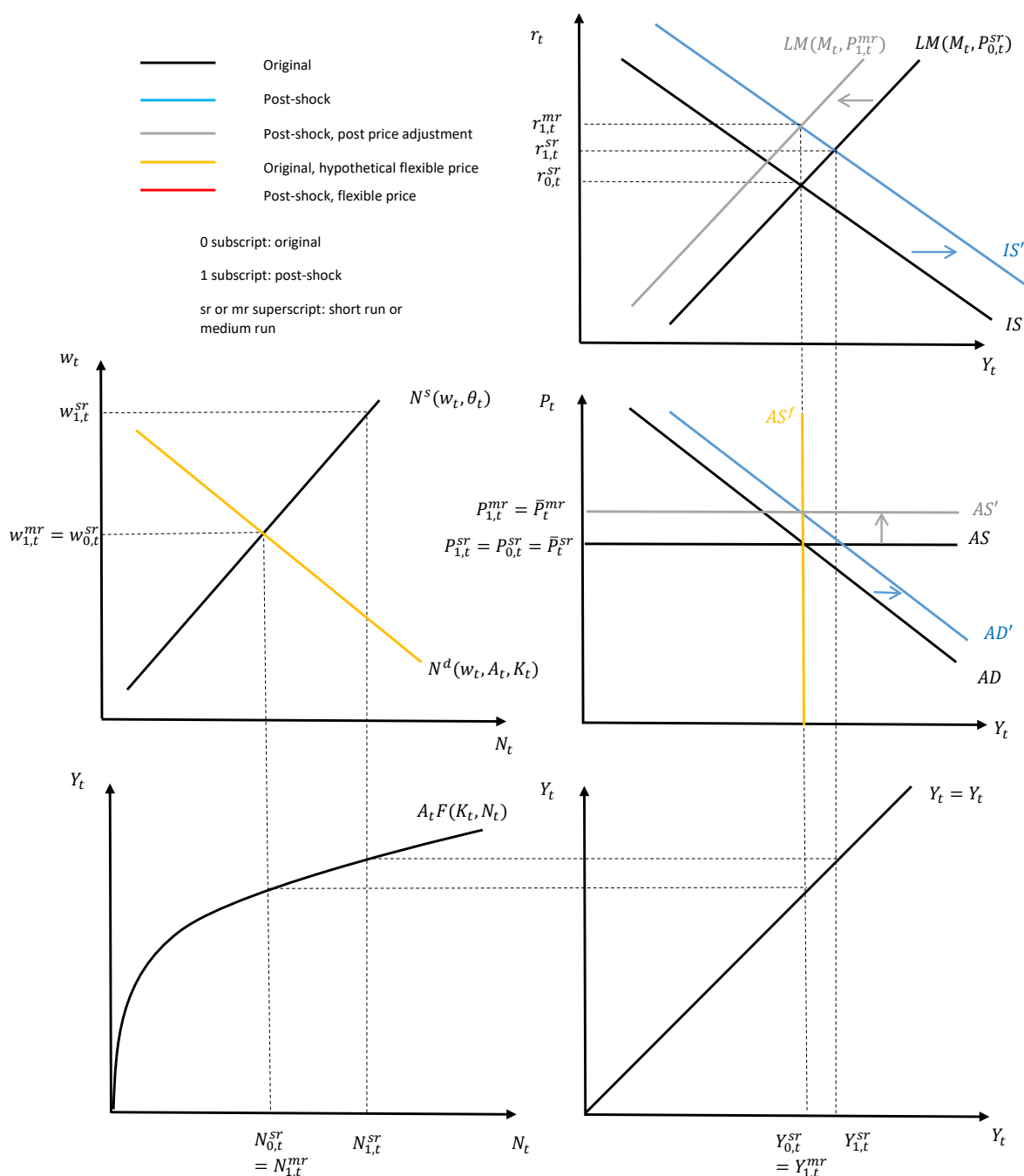

Since a positive IS shock does not impact the neoclassical level of output, in the short run the firm is producing more than it finds optimal. To reduce production, when given the opportunity to do so, the firm will increase its price to \bar{P}_t^{mr} . This results in the AS curve shifting up so as to intersect the new AD curve at the original level of output. At this new medium run equilibrium labor market variables are back to their pre-shock values. The

higher price level results in the LM curve shifting in so as to intersect the new IS curve at the original, pre-shock level of output. The real interest rate is higher than in the short run, with $r_{1,t}^{mr} > r_{1,t}^{sr}$. Figure 26.6 plots the responses of output, the price level, and the real interest rate to a positive IS shock over the course of period t . For years 1-2, output and the real interest rate jump up and the price level is unchanged. Once year 3 rolls around, the firm can raise its price. This results in output falling back to its original pre-shock value and the real interest rate rising even further, so that $r_{1,t}^{mr} > r_{1,t}^{sr} > r_{0,t}^{sr}$.

Figure 26.6: Short Run and Medium Responses: Positive IS Shock

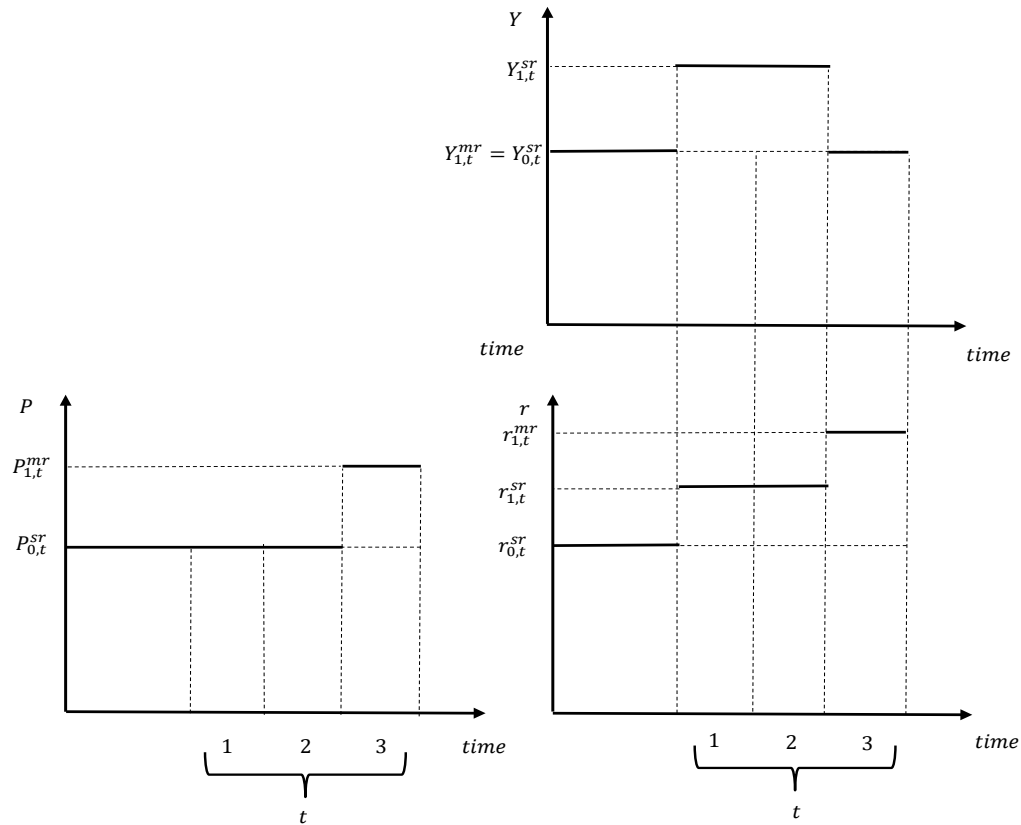

Next, consider an increase in A_t . In the simple sticky price model, since the AS curve is horizontal and solely determined by \bar{P}_t , this results in no effect on the equilibrium values output or the real interest rate in the short run. If output is unchanged but productivity is higher, labor input must decline in the short run. To support lower labor input, the real wage must fall. The hypothetical flexible price vertical AS curve shifts to the right – i.e. the neoclassical level of output increases to $Y_{1,t}^f$. This means that equilibrium output in the short run, $Y_{1,t}^{sr}$, is lower than it would be if the price level were flexible. Hence, there will be pressure on the firm to lower the price level. In Figure 26.7, we observe that this results in the AS curve shifting down (shown in gray) so as to intersect the AD curve at the new

hypothetical vertical AS curve. The lower price level triggers an outward shift of the LM curve, resulting in a lower real interest rate. The higher level of output necessitates more labor input, so both labor input and the real wage rise, ending up at the point where labor demand intersects labor supply.

Figure 26.7: Sticky Price Model: Increase in A_t , Short Run to Medium Run

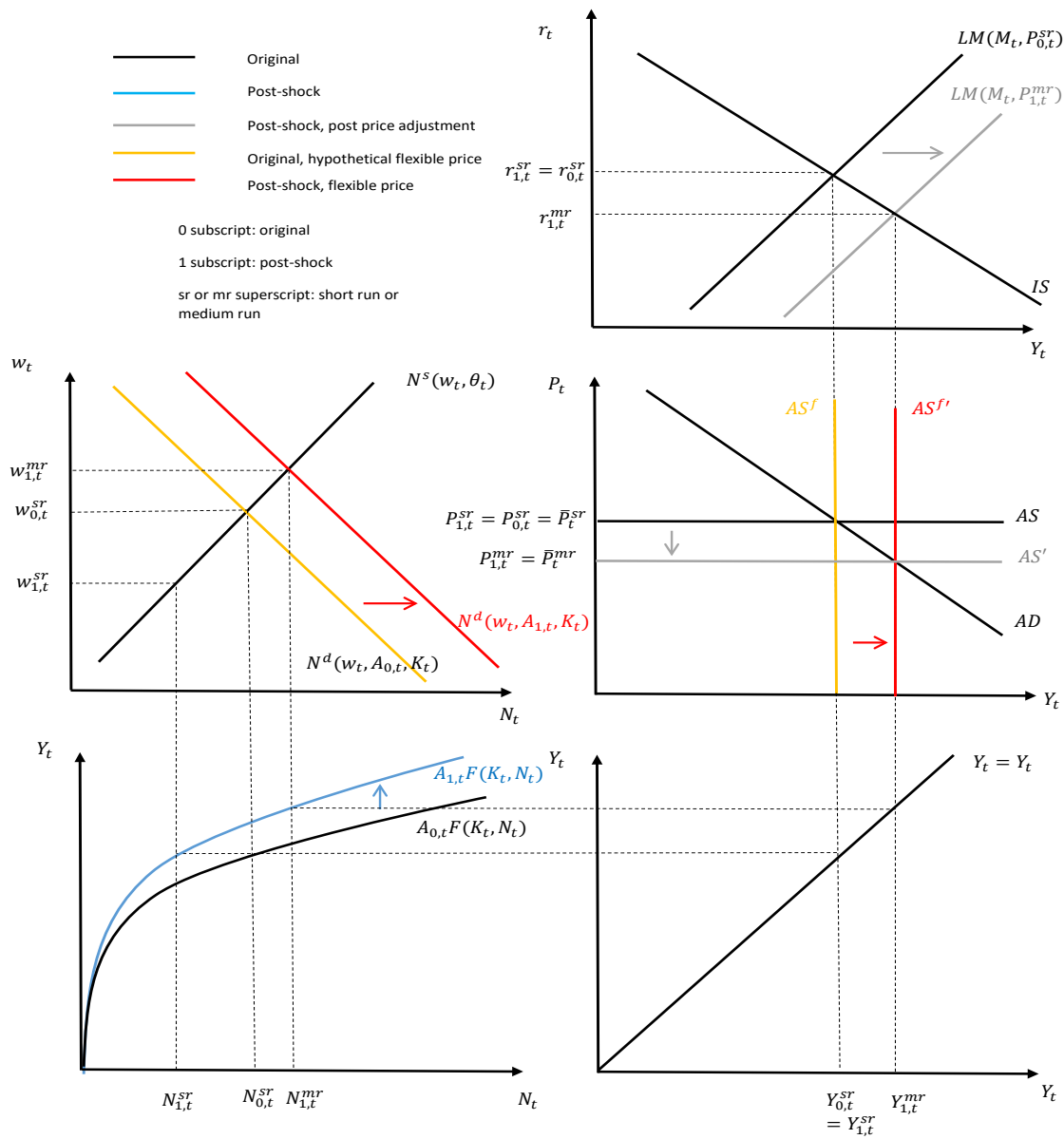
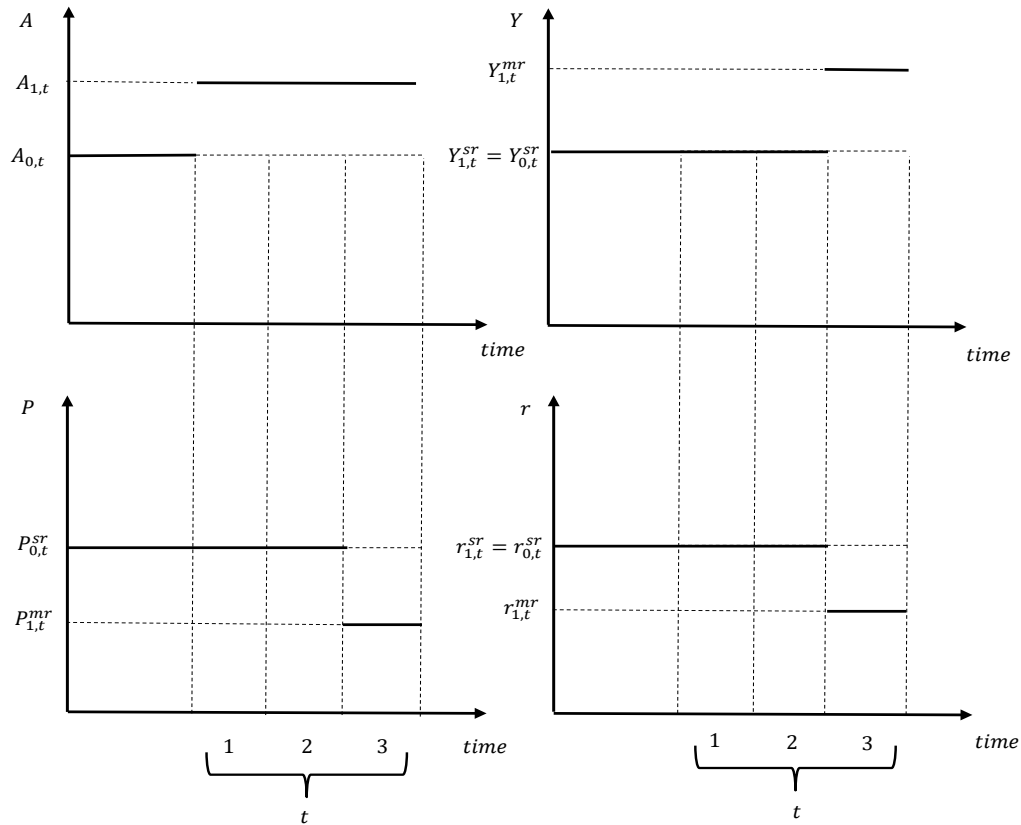

Figure 26.8 plots the responses of variables over period t to an increase in A_t (plotted in

the upper left quadrant). In the short run (years 1-2), output, the price level, and the real interest rate are all unaffected. Once the firm has had a chance to adjust its price in year 3, output jumps up to the neoclassical level and the price level and the real interest rate fall.

Figure 26.8: Short Run and Medium Responses: Increase in A_t



We leave an analysis of the dynamic effects of an increase in θ_t as an exercise. Table 26.1 shows how endogenous variables qualitatively react to exogenous shocks during the transition from the short run to the medium run. A + sign indicates that a variable increases, whereas a - sign indicates that a variable decreases. For example, in the column $\uparrow M_t$, the entry for output is a - sign. Output increases in the short run, but declines during the transition from short run to medium run. In the table, output and the price level always move in opposite directions during the transition period – if output is declining, the price level is increasing, and vice-versa. This is because it is the AS curve that is shifting during the transition from medium run to short run, so the price level and output must move opposite one another.

Table 26.1: Qualitative Effects of Exogenous Shocks on Endogenous Variables in the Sticky Price Model, Transition from Short Run to Medium Run

Variable	Exogenous Shock		
	$\uparrow M_t$	\uparrow IS curve	$\uparrow A_t$
Y_t	-	-	+
N_t	-	-	+
w_t	-	-	+
r_t	+	+	-
P_t	+	+	-

26.2 Partial Sticky Price Model

We next consider the partial sticky price model. The AS curve is given by $P_t = \bar{P}_t + \gamma(Y_t - Y_t^f)$. If $\gamma = 0$, then this reverts to the simple sticky price model. More generally, the AS curve is upward-sloping but not horizontal. As in the simple sticky price model, if $Y_t \neq Y_t^f$, changes in \bar{P}_t are what will occur to shift the AS curve as the economy transitions from short run to medium run.

26.2.1 A Non-Optimal Short Run Equilibrium

We first suppose that the initial short run equilibrium features equilibrium output below the neoclassical level of output; i.e. $Y_{0,t} < Y_{0,t}^f$. This is depicted in Figure 26.9.

Figure 26.9: Partial Sticky Price Model: $Y_{0,t} < Y_{0,t}^f$

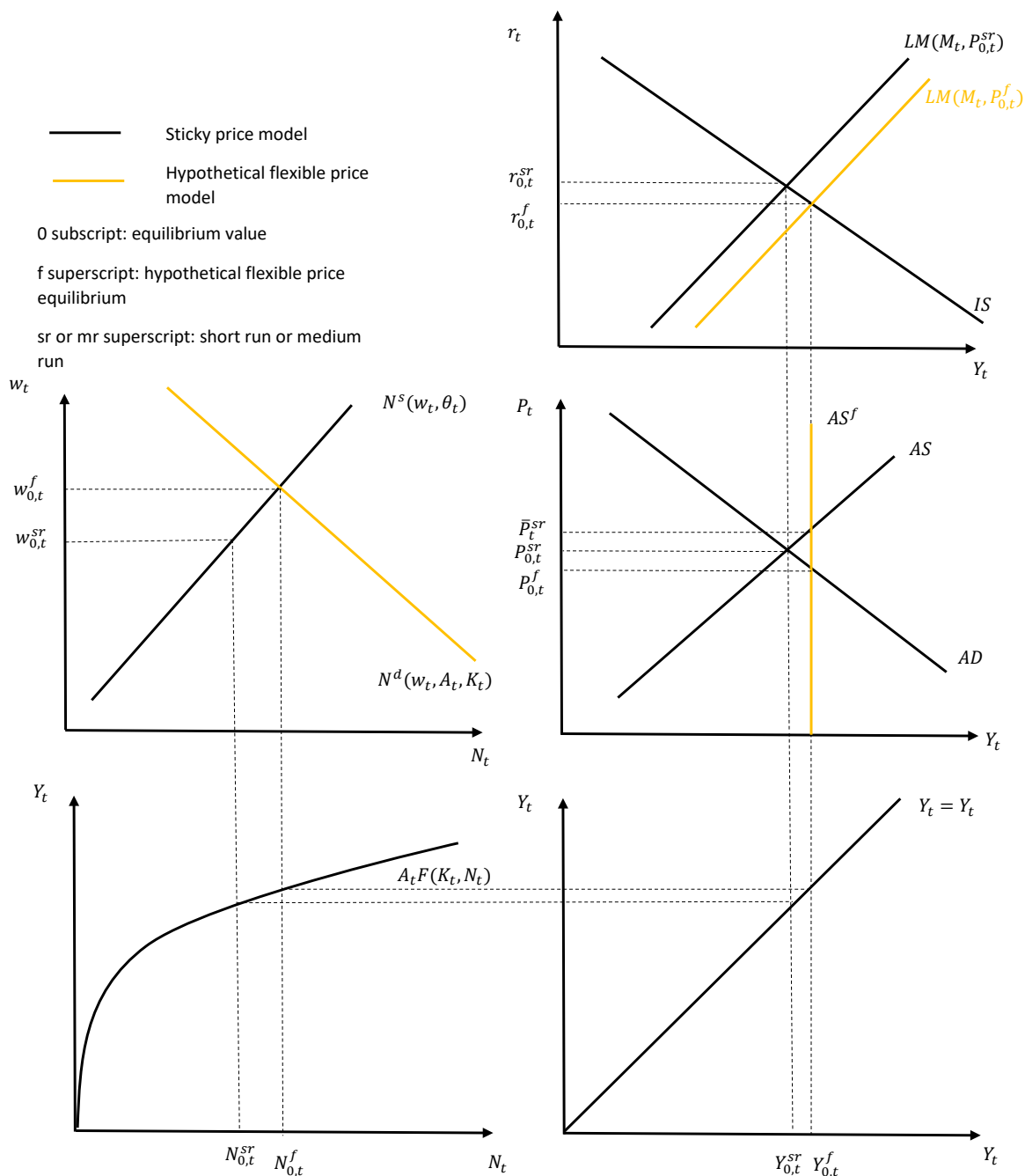

If the AS and AD curves intersect at a lower level of output than would obtain if prices were flexible and the AS curve were vertical, we know that it must be the case that $P_{0,t}^{sr} > P_{0,t}^f$ (i.e. the equilibrium price level if prices were flexible). We also know that the equilibrium price level, $P_{0,t}^{sr}$, must be less than the exogenous component of the price level, $\bar{P}_{0,t}^{sr}$. How do we know this? We know that the AS curve must pass through the point $Y_t = Y_t^f$ at \bar{P}_t^{sr} .

Since $Y_t^{sr} < Y_t^f$ initially, it must be the case that $\bar{P}_{0,t}^{sr} > P_t^{sr}$. What this means, in effect, is that the firm is stuck with a higher price than it would otherwise find optimal. It would like to lower its price to generate more demand. This means that, as the economy transitions from short run to medium run, \bar{P}_t will fall down to $P_{0,t}^f$. This will cause the AS curve to shift down so that it intersects the AD curve at $Y_{0,t}^f$. This movement is conceptually similar to what is documented in [26.2](#), only with an upward-sloping rather than vertical AS curve. The dynamic effects are shown in [Figure 26.10](#) below.

Figure 26.10: Partial Sticky Price Model: $Y_{0,t} < Y_{0,t}^f$, Short Run to Medium Run Price Adjustment

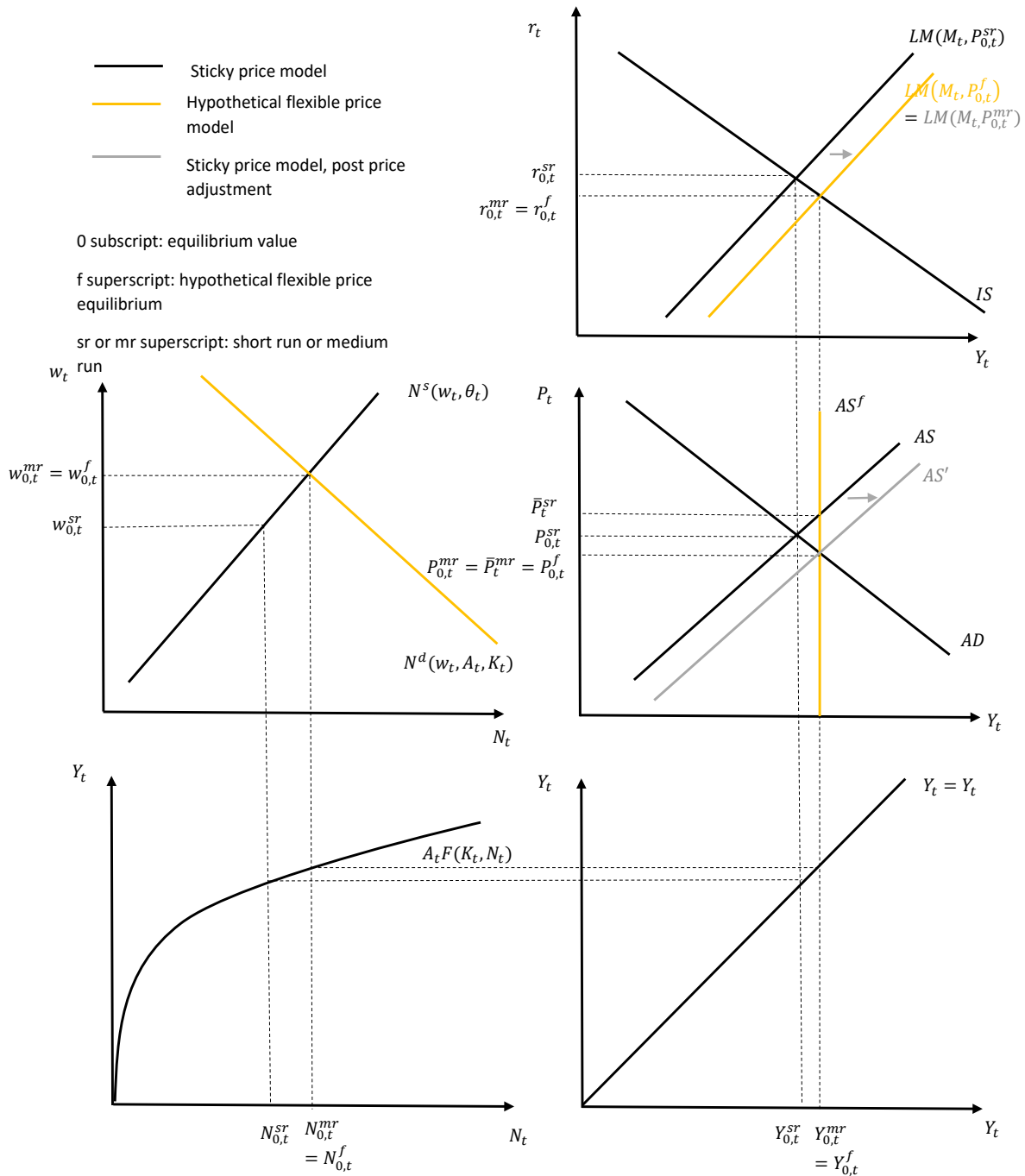

26.2.2 Dynamic Responses to Shocks

As we did above, we now consider the dynamic responses to exogenous shocks. We suppose that initially the equilibrium of the partial sticky price model coincides with the

equilibrium of a hypothetical flexible price economy. Then we consider an exogenous shock and look at how the values of endogenous variables change in the short run (denoted with a *sr* superscript). Then we ask how the AS curve must shift in response so as to restore the flexible price equilibrium in the medium run (once again denoted with a *mr* superscript).

We begin with an exogenous increase in M_t . This is depicted in Figure 26.11. The immediate impact of an increase in M_t is a rightward shift of the LM curve, shown in blue. This shift is drawn holding the price level fixed. This results in the AD curve shifting out to the right. Since the AS curve is not horizontal, in equilibrium, both output and the price level increase. This means that output will rise by *less* than the magnitude of the horizontal shift of the AD curve. The higher price level causes the LM curve to shift back in partially (shown in green). The real interest is lower than it was before the increase in the money supply. To support higher output, labor input must increase and the real wage must rise in the short run.

After the increase in the money supply, output is above potential and the equilibrium price level is higher than the exogenous component of the price level, i.e. $P_{1,t}^{sr} > \bar{P}_t^{sr}$. The firm is producing more than it finds optimal and would like to raise \bar{P}_t when given the opportunity to do so. In particular, \bar{P}_t^{mr} will increase in such a way that the AS curve shifts up so as to intersect the new AD curve at the original level of output (i.e. $Y_{1,t}^{mr} = Y_{0,t}^{sr}$). At the new medium run equilibrium, we have $P_{1,t}^{mr} = \bar{P}_t^{mr}$. The increase in the price level triggers an inward shift of the LM curve so that on net the position of the LM curve is unaffected, leaving the real interest rate unchanged relative to its pre-shock value. Labor market variables are unchanged relative to their values from before the increase in the money supply.

Figure 26.11: Partial Sticky Price: Increase in M_t , Short Run to Medium Run

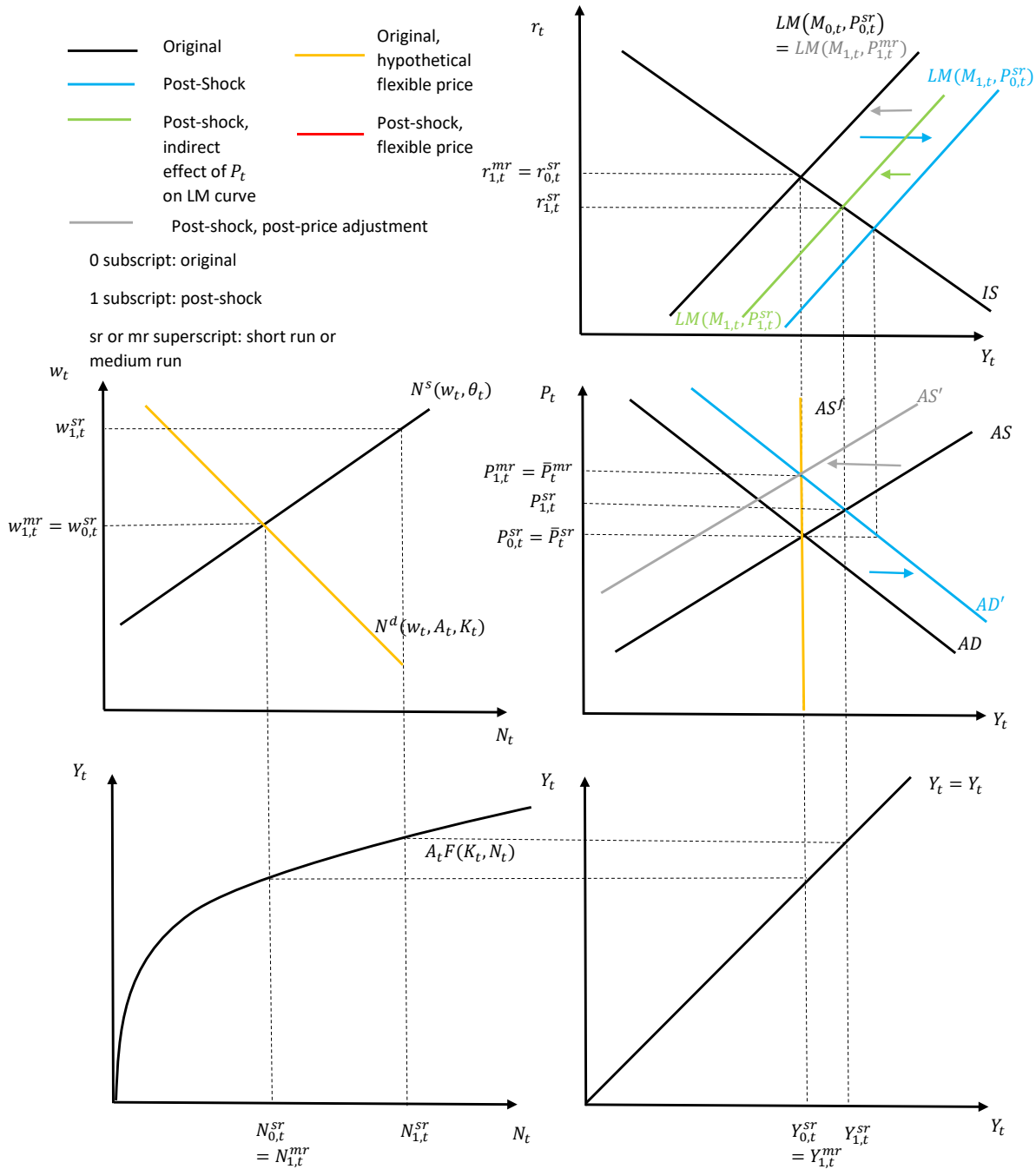
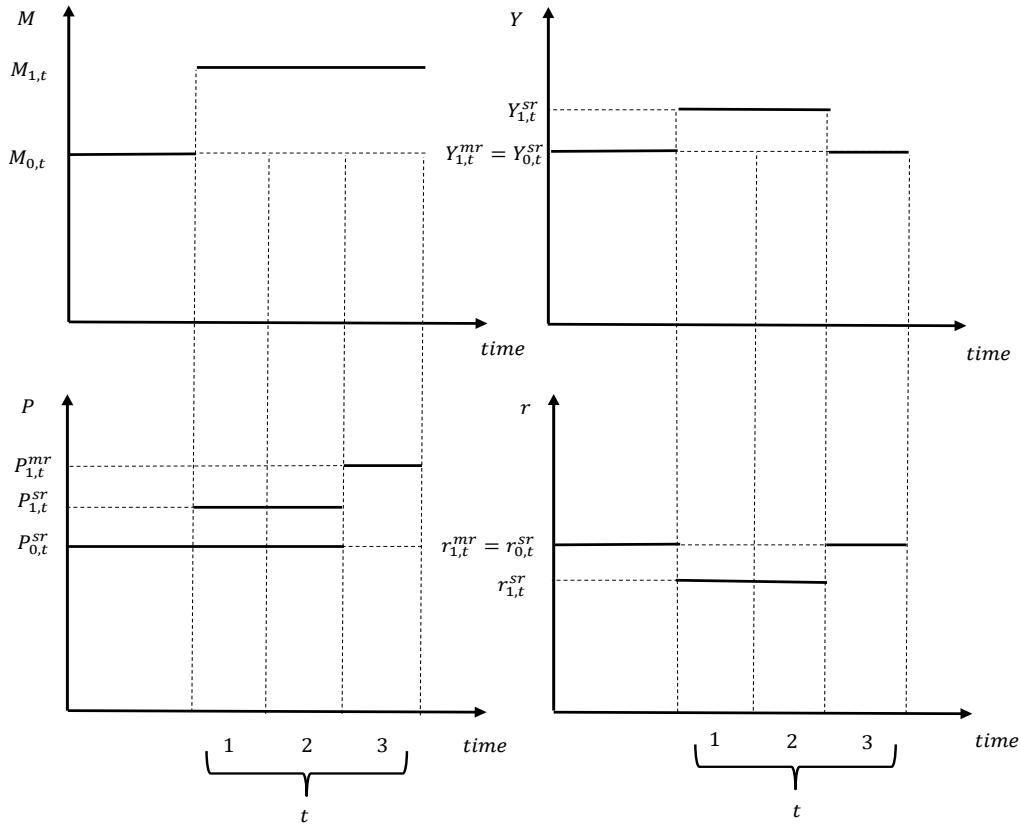

Figure 26.12 plots the dynamic paths of different variables throughout period t , which we again divide into three segments – years 1 and 2 are the short run, while by year 3 it is the medium run. 0 subscripts denote values prior to an exogenous shock, while 1 subscripts refer to values post-shock. Output increases in the short run from $Y_{0,t}^{sr}$ to $Y_{1,t}^{sr}$, but in the medium run returns to its initial level, $Y_{1,t}^{mr} = Y_{0,t}^{sr}$. The price level increases in the short run, from

$P_{0,t}^{sr}$ to $P_{1,t}^{sr}$, and increases by more moving from short run to medium run, with $P_{1,t}^{mr} > P_{1,t}^{sr}$. The real interest rate declines in the short run before returning to its pre-shock value in the medium run.

Figure 26.12: Short Run and Medium Responses: Increase in M_t



To compare the behavior of the economy across the partial and simple sticky price models, in Figure 26.13 we plot the paths of variables in both the partial sticky price model (black) and the simple sticky price model (blue). This is essentially a combination of Figures 26.4 and 26.12. For the same change in the money supply, in the short run output reacts more in the simple sticky price model compared to the partial sticky price model. In contrast, the price level reacts more in the short run in the partial sticky price model. The real interest rate falls more in the simple sticky price model. The value of γ (i.e. the slope of the AS curve in the partial sticky price model) determines where the partial sticky price responses lie compared to (i) the simple sticky price responses and (ii) the medium run responses. The smaller is γ , the closer will be the partial sticky price model responses to the simple sticky price model in the short run, while the bigger is γ , the closer these responses in the short run will be to the medium run values. Note that the medium run values of endogenous variables are *the same* for both the partial and simple sticky price models.

Figure 26.13: Short Run and Medium Responses: Increase in M_t
 Comparing Simple Sticky Price to Partial Sticky Price Model

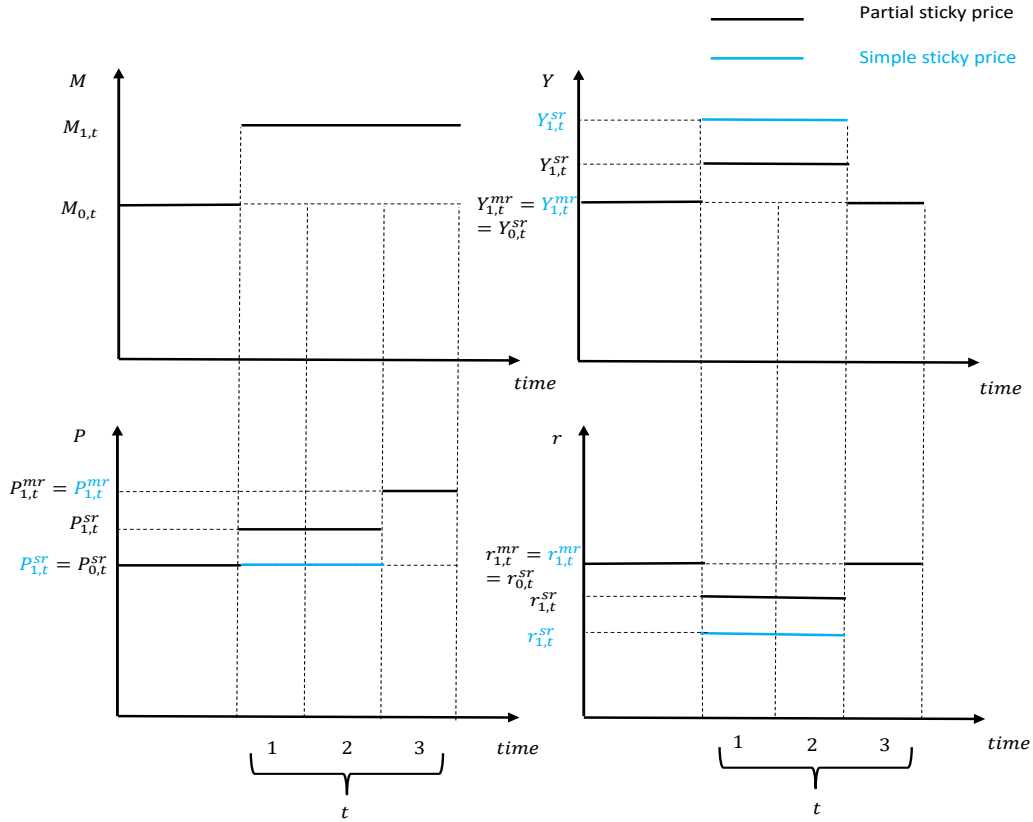

We next consider some shock which shifts the IS curve to the right (i.e. increases in A_{t+1} or G_t or a decrease G_{t+1}). This is depicted in Figure 26.14. The rightward shift of the IS curve triggers a rightward shift of the AD curve. In equilibrium, both output and the price level rise in the short run. The higher price level causes the LM curve to partially shift back in to the left (shown in green). The real interest rate is higher. To support higher output, labor input rises and the real wage rises. In the new short run equilibrium, output is above potential and the price level is greater than the exogenous component of the AS curve (i.e. $P_{1,t}^{sr} > \bar{P}_t^{sr}$). The firm has an incentive to increase its price to reduce production. As the economy transitions from short run to medium run, the exogenous component of the price level will increase to \bar{P}_t^{mr} . This is sufficient to shift the AS curve up (shown in gray) such that it intersects the new AD curve at the original, pre-shock value of output. At the new medium run equilibrium we have $P_{1,t}^{mr} = \bar{P}_t^{mr}$. The higher price level causes the LM curve to shift in such that it intersects the new IS curve at the pre-shock level of output. This results in a further increase in the real interest rate, with $r_{1,t}^{mr} > r_{1,t}^{sr}$. Relative to prior to the shock, there are no changes in labor market variables.

Figure 26.14: Partial Sticky Price: Positive IS Shock, Short Run to Medium Run

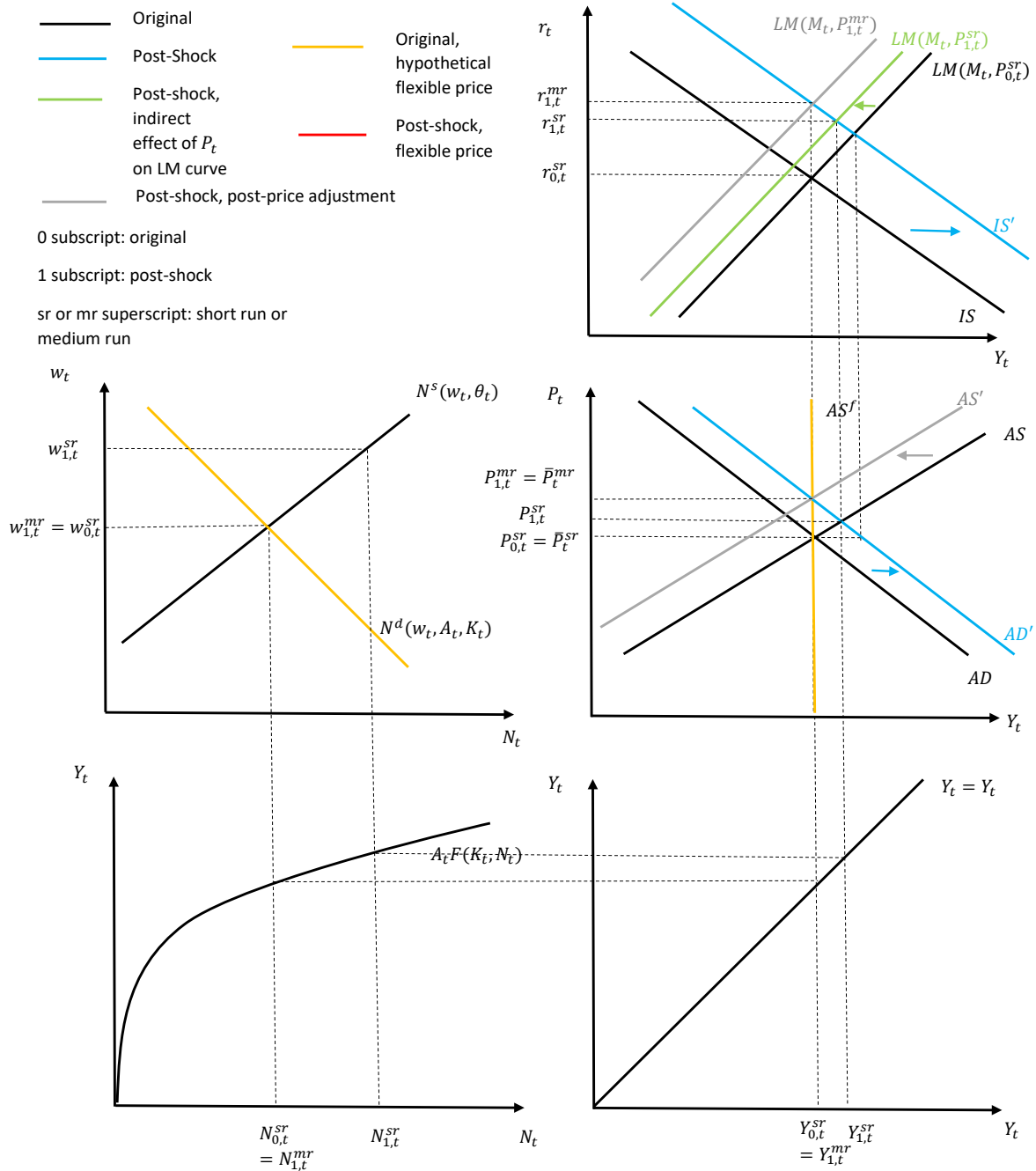
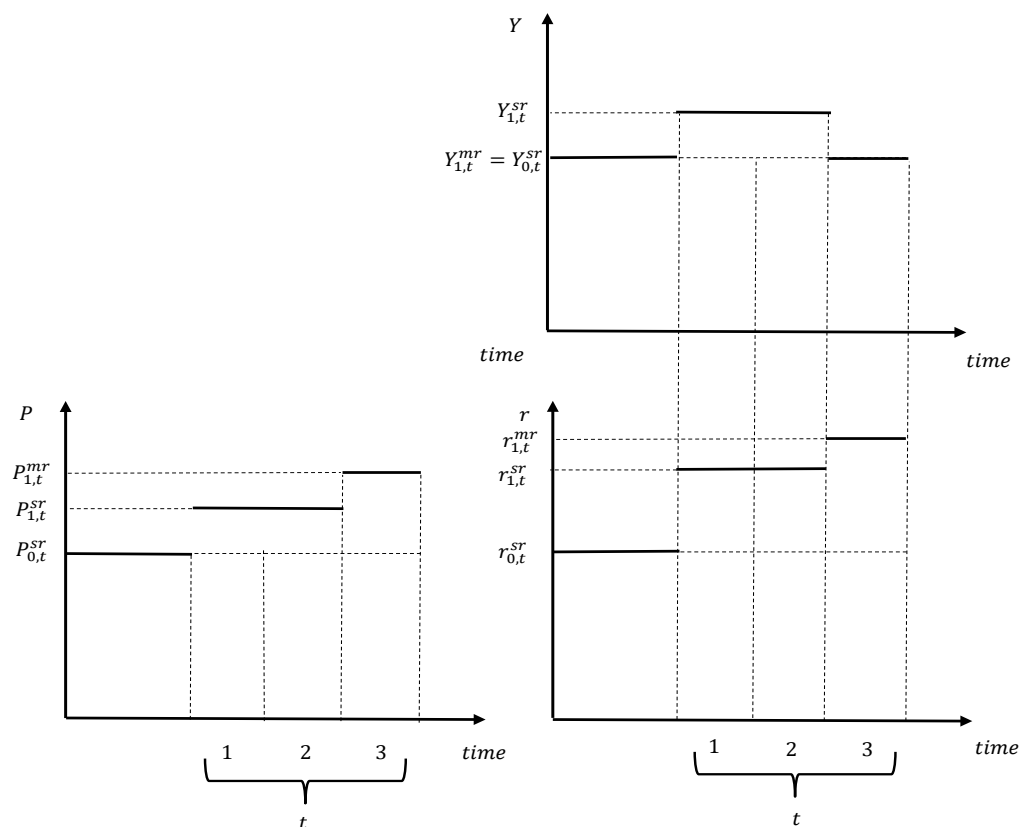

Figure 26.15 plots the paths of variables in response to the IS shock over period t . Output, the price level, and the real interest rate all rise in the short run. Although we do not show the comparison formally here, the short run increase in output is smaller than in the simple sticky price model and the short run increase in the real interest rate is larger. As the economy transitions to the medium run (i.e. in year 3), the price level and the real interest

rate rise further, with output returning to its pre-shock value.

Figure 26.15: Short Run and Medium Responses: Positive IS Shock



Next consider an exogenous increase in A_t . As Figure 26.16 shows, this causes the AS curve to shift out horizontally to the right (shown in blue). The magnitude of the horizontal shift is identical to the magnitude of the horizontal shift of the hypothetical vertical neoclassical AS curve (which can be found by finding the level of N_t consistent with being on both labor demand and supply curves consistent with the production function). But because the AS curve is not vertical, in equilibrium output rises by *less* than the flexible price, neoclassical level of output does (i.e. the change in output is *smaller* than the horizontal shift of the AS curve). The price level falls. The lower price level triggers an outward shift of the LM curve and a resulting decline in the real interest rate. It is ambiguous what happens to labor input and the real wage – if the AS curve is relatively flat, these will likely both fall, whereas if the AS curve is comparatively steep, they may both rise. The figure is drawn for the case where both fall in the short run.

Figure 26.16: Partial Sticky Price: Effect of Increase in A_t , Dynamics

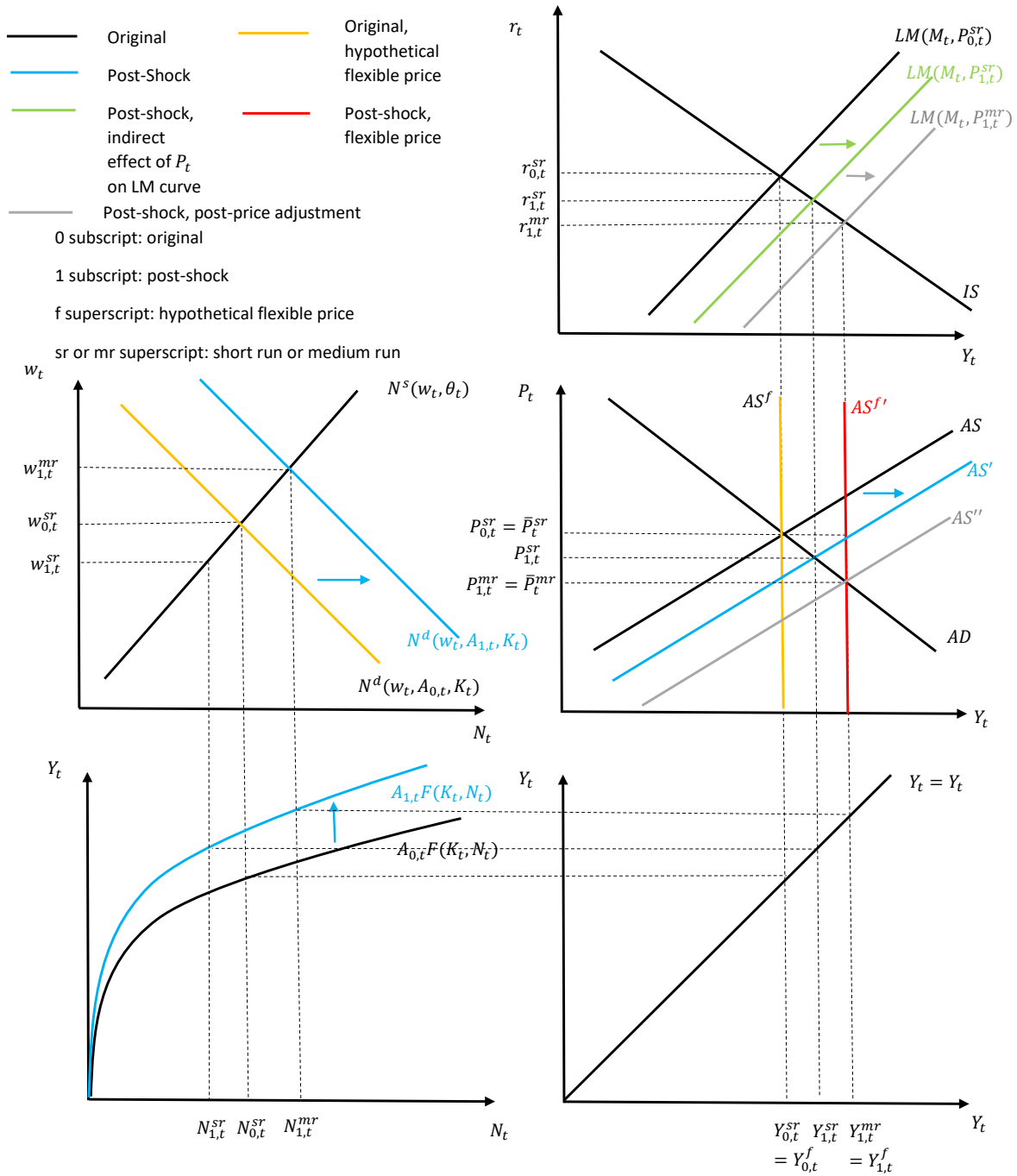

In the short run, output, $Y_{1,t}^{sr}$, is *less* than the neoclassical level of output, $Y_{1,t}^f$. The firm is producing less than it finds optimal. Once given the opportunity to do so, it will lower the exogenous component of the price level to \bar{P}_t^{mr} so as to stimulate demand and increase production. This will result in the AS curve shifting down (shown in gray) such that it intersects the AD curve at the new neoclassical level of output. The price level declines

further relative to its short run value, which results in a further outward shift of the LM curve and resulting further decline in the real interest rate. As output rises relative to the short run, labor input and the real wage also increase. Figure 26.17 plots the paths of variables across period t . Output rises, the price level falls, and the real interest rate falls in the short run. Relative to the medium run, these variables all “under-shoot” in that they move by less than they would if the price level were flexible. As the transition to the medium run takes place, output rises further, the price level declines more, and the real interest rate declines further.

Figure 26.17: Short Run and Medium Responses: Increase in A_t

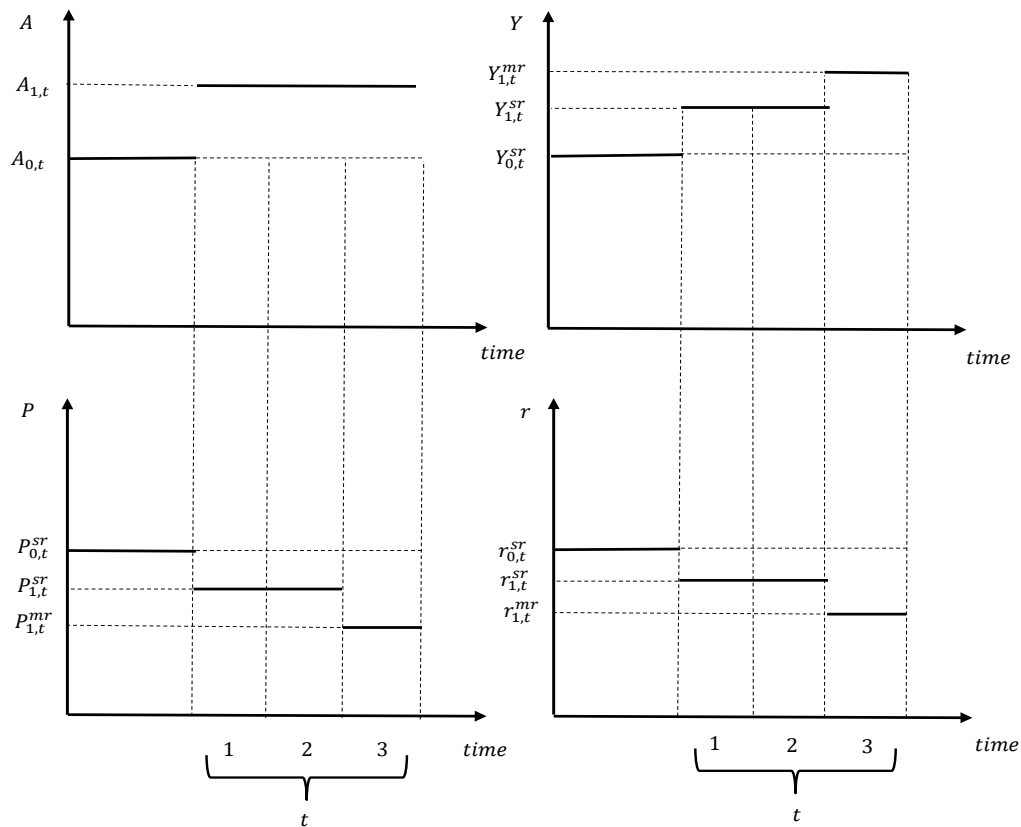

Table 26.2 qualitatively describes how different endogenous variables transition from short run to medium run in the partial sticky price model. These are qualitatively *identical* to what happens in the transition from short run to medium run in the simple sticky price model. Quantitatively, the transitions in the partial sticky price model are *smaller* than in the simple sticky price model. For example, after an increase in M_t , output declines *less* in the transition from short run to medium run in the partial sticky price model because it increases by *less* in the short run.

Table 26.2: Qualitative Effects of Exogenous Shocks on Endogenous Variables in the Partial Sticky Price Model, Transition from Short Run to Medium Run

Variable	Exogenous Shock		
	$\uparrow M_t$	\uparrow IS curve	$\uparrow A_t$
Y_t	-	-	+
N_t	-	-	+
w_t	-	-	+
r_t	+	+	-
i_t	+	+	-
P_t	+	+	-

26.3 The Phillips Curve

In macroeconomics, the so-called “Phillips Curve” is a name given to a relationship between some measure of real economic activity (e.g. the output gap, $Y_t - Y_t^f$) and some measure of changes in nominal prices (e.g. the price inflation rate). Originally the Phillips Curve was simply an empirical observation noted in historical data. It was named after A.W.H. Phillips, who documented a clear negative relationship between wage inflation (the rate of growth of nominal wages) and the unemployment rate in the United Kingdom (see [Phillips \(1958\)](#)). Most subsequent analyses of so-called Phillips Curve focus on general price inflation, rather than wage inflation. Also, many modern expositions use a measure of the output gap rather than unemployment as the “real” variable in the model. We will also follow this approach, particularly since our model (as laid out) doesn’t feature unemployment as traditionally defined (we will return to this issue later in [Chapter 16](#)).

[Figure 26.18](#) shows a scatter plot (with a best-fitting regression line drawn in) between inflation on the vertical axis and the output gap on the horizontal axis for US data since 1960. To compute the output gap, we measure Y_t^f as the CBO’s measure of “potential output.” This concept does not necessarily coincide with the concept of Y_t^f as being the hypothetical neoclassical level of output, but it is as close as we can easily get. In the figure, the output gap is measured in percentage deviations (so that 0.02 means that output is 2 percent above potential) and inflation is measured in annualized percentage units (so 4 means inflation, as measured by the GDP price deflator, is 4 percent in annualized terms).

Figure 26.18: Inflation and the Output Gap

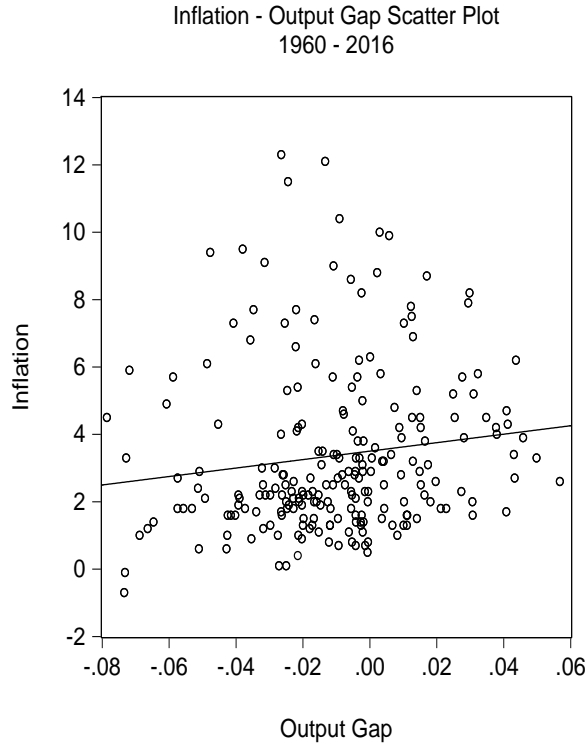

Each circle in the figure represents an inflation-output gap pair from a particular point in time. The empirical relationship between the output gap and inflation observed in the data is positive. Phillips' original observation noted a *negative* relationship between wage inflation and the unemployment rate. This is consistent with the data in Figure 26.18 because one would expect the unemployment rate to be negatively correlated with the output gap.

The Phillips Curve, as defined, is simply an empirical regularity. Does it have any basis in theory? It turns out that it does. The theoretical underpinnings of the Phillips Curve relationship can most easily be seen by focusing on the partial sticky price model. The assumed AS curve in that model is given by $P_t = \bar{P}_t + \gamma(Y_t - Y_t^f)$. This is written in terms of the price level. To think about changes in the price level (i.e. to think about inflation rates), simply subtract P_{t-1} from both sides to get:

$$P_t - P_{t-1} = \bar{P}_t - P_{t-1} + \gamma(Y_t - Y_t^f) \quad (26.1)$$

If we assume that the lagged price level is normalized to one, so that $P_{t-1} = 1$, then the change in the price level also corresponds to the inflation rate (i.e. the percentage change in the price level). Then (26.1) can be written:

$$\pi_t = \pi_t^e + \gamma(Y_t - Y_t^f) \quad (26.2)$$

In (26.2), we have defined $\pi_t = P_t - P_{t-1}$ and $\pi_t^e = \bar{P}_t - P_{t-1}$. We can think of π_t^e as measuring expected inflation – the exogenous component of the price level less the lagged price level. Since firms would presumably choose \bar{P}_t so that in expectation $Y_t = Y_t^f$, we can think of π_t^e as measuring the inflation rate that firms expect to obtain in period t . If inflation ends up higher than this, then output will be above potential, and vice-versa. Expression (26.2) is often referred to as an “expectations augmented Phillips Curve” after [Friedman \(1968\)](#) and [Phelps \(1967\)](#).

The empirical relationship documented in the scatter plot in [Figure 26.18](#) is relatively weak. In fact, it masks strong sub-sample differences, as can be seen in [Figure 26.19](#) below:

Figure 26.19: Inflation and the Output Gap

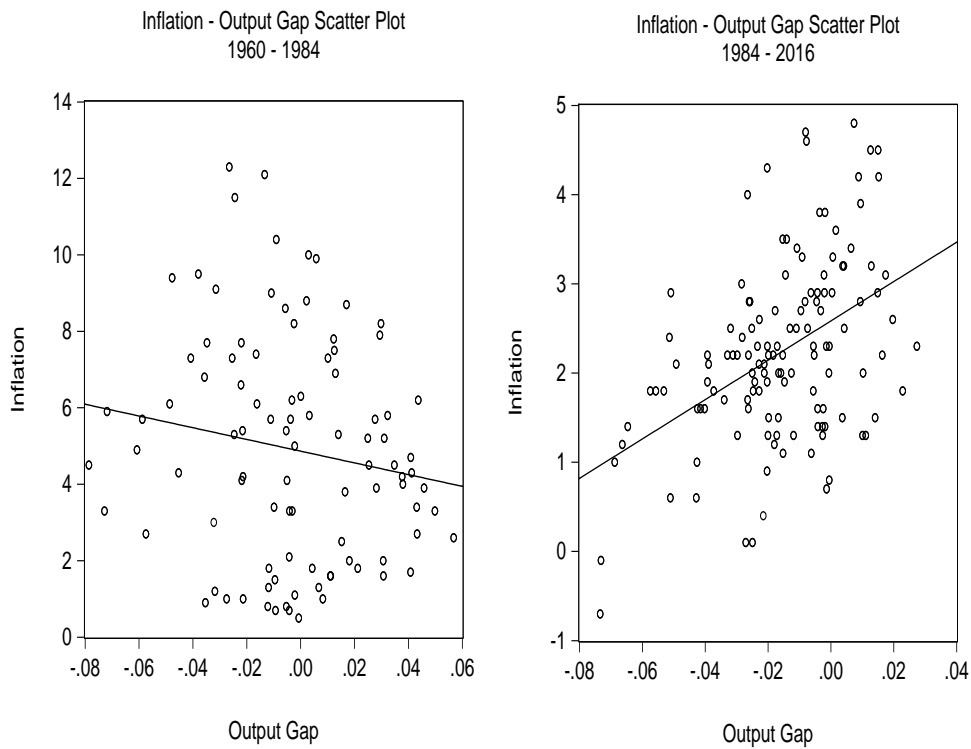

For the 1960-1984 period, the relationship between the output gap and inflation is weak, and the best-fitting line through all the circles is actually negatively sloped, which is inconsistent with the predictions of the New Keynesian model. For the 1984 to present period, in contrast, the relationship between the output gap and inflation is quite strong and positive – one can clearly see a positive relationship just by looking at all the circles in the figure. The full sample scatter plot (and best-fitting line) is roughly an average of the

two sub-sample scatter plots. So there is one part of the sample where the theory-implied relationship between the output gap and inflation fits the data very well, one part of the sample where the empirical relationship is at odds with the data, and over the whole sample the relationship between inflation and the output gap is consistent with the theory but only weakly so.

Our analysis in (26.1)-(26.2) gives us one way to potentially make sense of the empirical regularities documented in Figure 26.19. In particular, theory suggests that we should only expect to observe a positive relationship between the output gap and inflation to the extent to which π_t^e is stable (equivalently, \bar{P}_t is not shifting around significantly relative to P_{t-1}). Has this always been the case? Figure 26.20 plots average current quarter expected inflation across time. These data are obtained from the Survey of Professional Forecasters (SPF), a survey of professional forecasters which is administered quarterly by the Federal Reserve Bank of Philadelphia. These data are available beginning in 1970.

Figure 26.20: Average Inflation Expectations

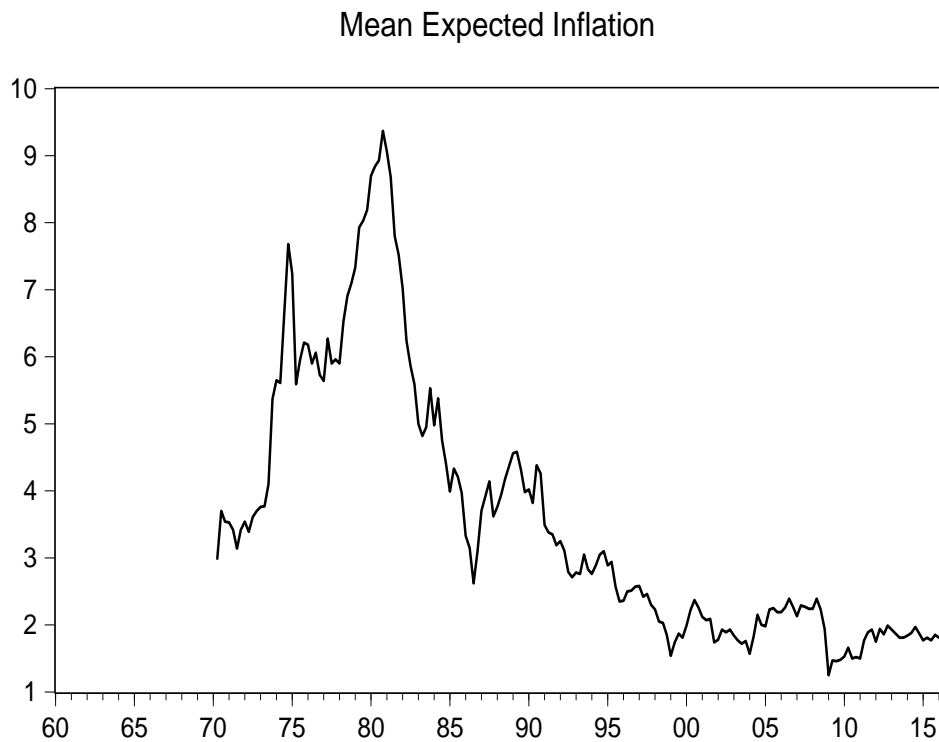

From Figure 26.20, we can draw two key observations. First, expected inflation was much higher in the 1970s and early 1980s than it has been since. This coincides with the behavior of actual price inflation, which was high in the 1970s and early 1980s and much lower since. Second, expected inflation was significantly more volatile in the early sample period in comparison to the later period. Since the early 1990s, expected inflation has been

quite stable. The fact that expected inflation was not stable during the early part of the sample provides a potential rationale for the empirical regularities documented in Figure 26.19. In particular, if π_t^e is fluctuating substantially (which in terms of our partial sticky price model would mean significant period-to-period changes in \bar{P}_t relative to P_{t-1}), we would not necessarily expect to see a positive relationship between π_t and $Y_t - Y_t^f$. Indeed, in the model an exogenous increase in \bar{P}_t would result in $Y_t - Y_t^f$ falling (since Y_t would fall and Y_t^f would be unaffected) while P_t would rise, implying a *negative* relationship between the inflation rate and the output gap. This can help us understand why we observe a weak and slightly negative relationship between inflation and the output gap in the early part of the sample. In contrast, in the later part of the sample, expected inflation seems to be quite stable, and, consistent with the theory, we observe a robust positive relationship between the output gap and inflation.

The stabilization of inflation expectations in the last thirty or so years is widely considered to be both a significant and important achievement by the Federal Reserve. As we will discuss in Chapter 27, to the extent to which \bar{P}_t is stable (equivalently, π_t^e is not moving around much), a central bank can simultaneously stabilize the output gap and inflation about target.

26.3.1 Implications of the Phillips Curve for Monetary Policy

Due to nominal rigidity, a one time increase in M_t can temporarily raise output in the New Keynesian model. This effect eventually goes away as the economy transitions from short run to medium run, with the price level adjusting so that the only ultimate effect of an increase in M_t is a higher price level.

A question worth pondering is the following: can a central bank persistently generate $Y_t > Y_t^f$ (i.e. high output) by continually increasing the money supply? For the partial sticky price version of the Phillips Curve above, (26.2), this would seem to be the case. A central bank could evidently achieve $Y_t > Y_t^f$ if it were willing to tolerate higher inflation, provided that expected inflation, π_t^e , is unaffected by such a policy. This last provision is important. It is only possible for $Y_t > Y_t^f$ if $\pi_t > \pi_t^e$. In other words, monetary neutrality in the model in a sense obtains by “fooling” people. If prices end up higher or lower than the firm expected, the existence of nominal rigidity triggers temporary deviations of output from its neoclassical level.

While it seems possible that the firm could temporarily be fooled, it does not seem likely that it could be continually fooled. In other words, it should not be possible for a central bank to persistently push output above potential. If that is the central bank’s objective, the firm should catch on and adjust its expectations and behavior in such a way as to undo any

potential real effects of monetary expansion.

To see this point clearly, suppose that the central bank increases M_t , but that this is *completely anticipated* by the firm in advance. Since the firm finds it optimal to produce the neoclassical level of output, a firm with this anticipation would increase \bar{P}_t in anticipation of the increase in M_t . The firm should not be caught surprised. It should preemptively raise its price by increasing \bar{P}_t in such a way that there would be no effect of the increase in M_t on Y_t . In effect, an anticipated increase in M_t would cause the AD curve to shift right and but the AS curve to simultaneously shift up in such a way as to leave output unaffected. In terms of (26.2), a fully anticipated monetary expansion would be met with a coincident increase in π_t and π_t^e , leaving output unaffected. This is documented for the partial sticky price model in Figure 26.21 below:

Figure 26.21: Sticky Price Model: Anticipated Increase in M_t , Reflected in π_t^e

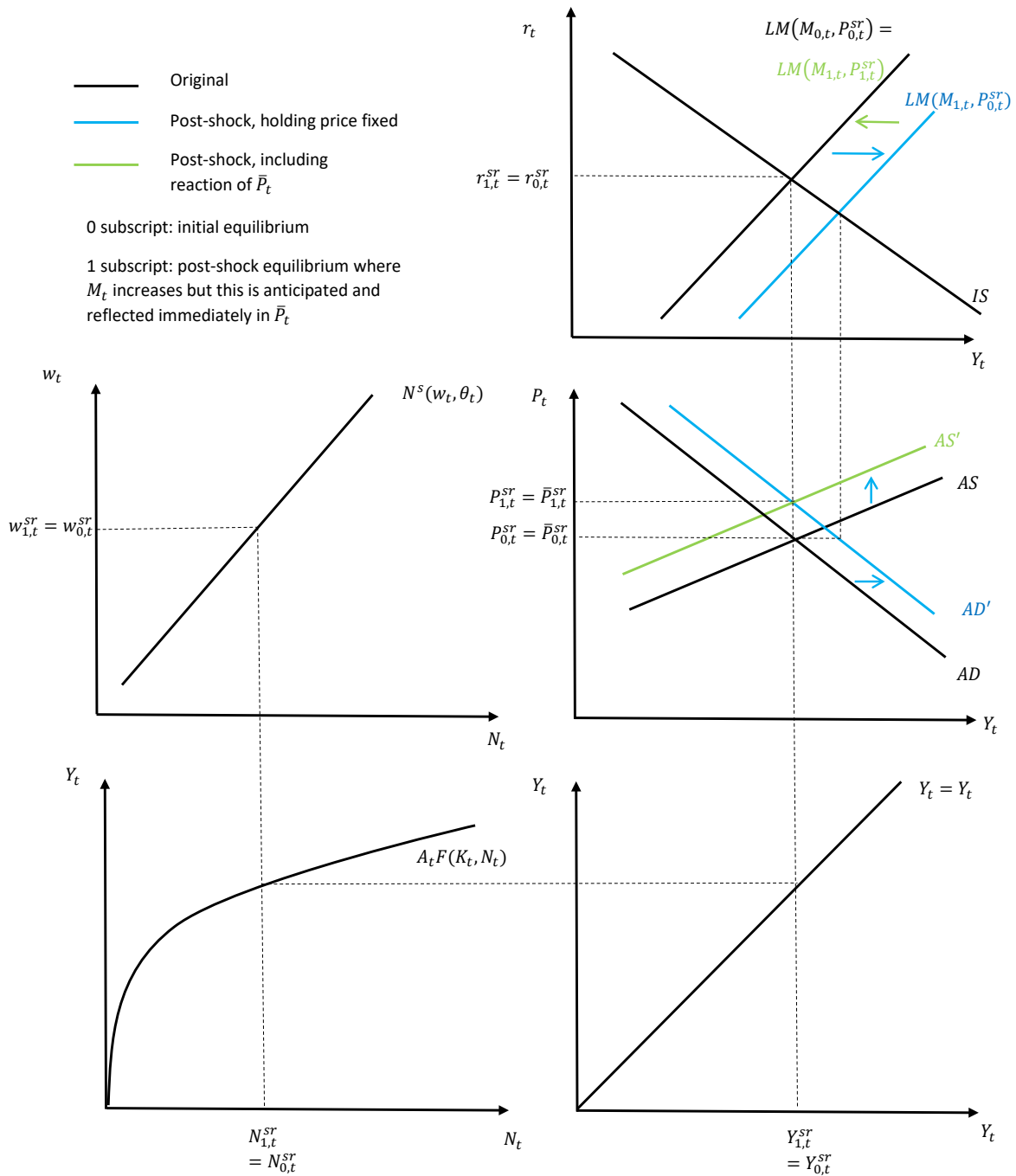

Our analysis suggests that changes in the money supply can have real effects by, in a sense, fooling private agents. This is the point raised in the classic paper by Lucas (1972). If agents do not anticipate the change in the money supply and the price level is at least partially set in advance, then output expands when M_t increases. But if the change in the money supply is fully anticipated, the price level can adjust in advance, with no change in

any real variable resulting from the increase in the money supply. In a sense, if the change in the money supply is fully anticipated, then there is no distinction between the short run and the medium run – it is as if the price level is perfectly flexible. If a central bank were to engage in a policy of trying to repeatedly push output above potential, it stands to reason that private sector agents would catch on to the scheme sooner or later, and the policy would not be effective at raising output, and would only generating persistently higher inflation.

26.3.2 The Possibility of Costless Disinflation

Suppose that a central bank desires to reduce the price level in an economy (or inflation, if you prefer). How can it do this, and what are the costs associated with disinflation (by which we mean a policy designed to reduce the price level, or the rate of growth of the price level)?

For the purposes of this section, we will focus on the partial sticky price model. Similar conclusions emerge in the simple sticky price model. Suppose that the central bank desires to reduce the price level. It can do this by reducing the money supply. If this reduction in the money supply is unanticipated by agents in the economy, output must decline in the short run. The effects of a reduction in the money supply are shown below in Figure 26.22. The reduction in the money supply causes the AD curve to shift in. This causes output to fall from $Y_{0,t}^{sr}$ to $Y_{1,t}^{sr}$ in the short run. As the economy transitions to the medium run, the firm will adjust the price level to \bar{P}_t^{mr} , the AS curve will shift down, and output will return to where it started with the desired fall in the price level eventually happens. Bringing the price level down evidently requires enduring a recession (a period of low output) in the short run.

Figure 26.22: Sticky Price Model: Unanticipated Disinflation

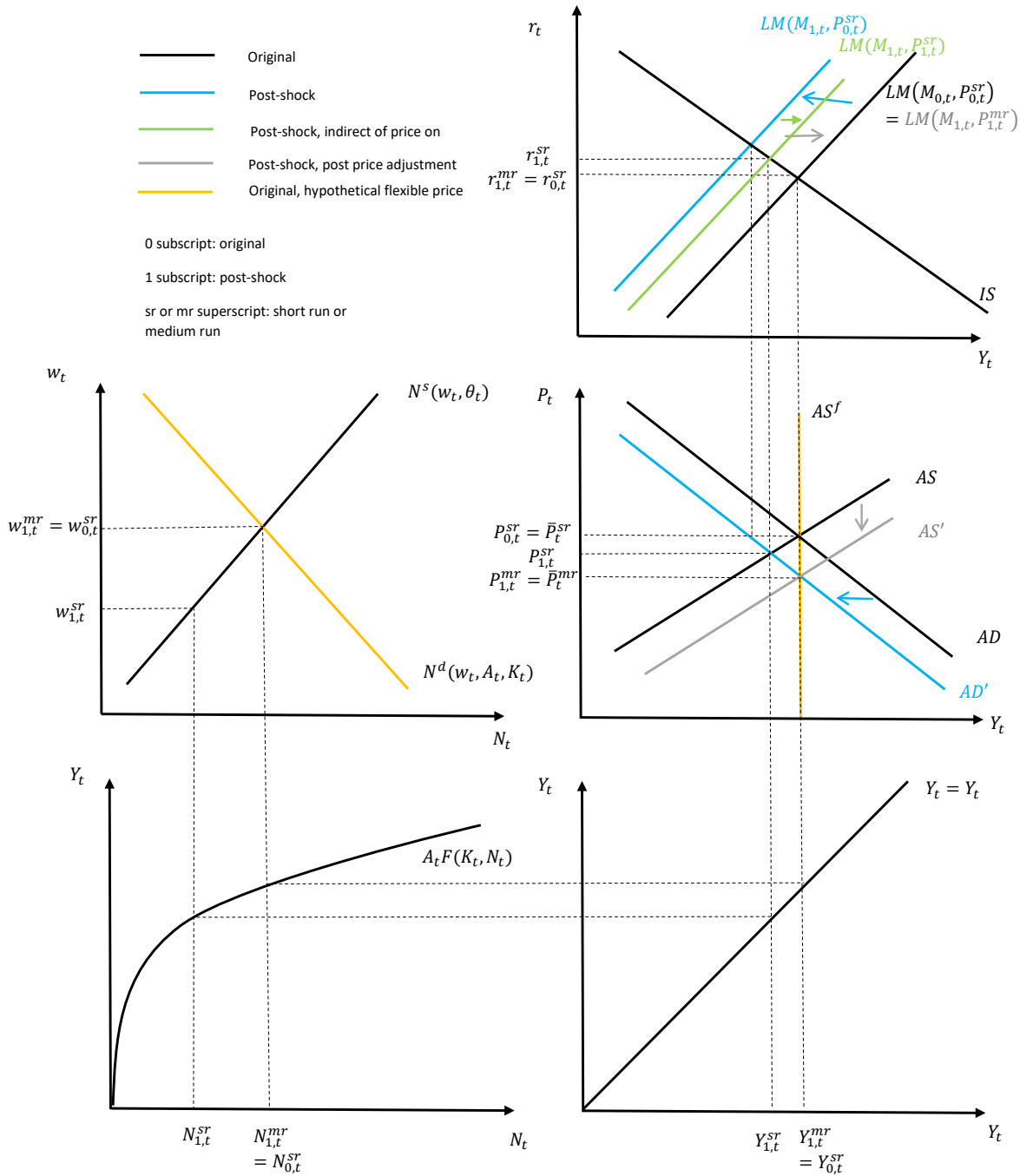

Economists have adopted the term “sacrifice ratio” as the ratio of the percentage of lost output to the percentage change in inflation. So, if a central bank wants to reduce the inflation rate by 1 percent and output falls by 5 percent, the sacrifice ratio is 5. The experience of the US economy during the early 1980s suggests that the sacrifice ratio is large. As Fed chairman, Paul Volcker sought to bring the US inflation rate down from the high

levels it had experienced during the 1970s. Inflation fell from about 9 percent in 1981 to about 4 percent in 1983. Relative to trend, real GDP fell by about 10 percent over the same period. This suggests the sacrifice ratio associated with the Volcker disinflation was about 2.

Our analysis from the previous subsection suggests, in contrast to the experience of the US in the early 1980s, that disinflation need not be costly. In particular, suppose that a central bank effectively communicates its desire to lower the price level to the public in advance of reducing the money supply. If it does this, the firm will lower its price level in advance of the reduction in M_t . As a result, while the AD curve will shift in, the AS curve will shift down simultaneously, resulting in no change in real variables but a reduction in the price level. These effects are shown below in Figure [26.23](#).

Figure 26.23: Sticky Price Model: Anticipated Disinflation

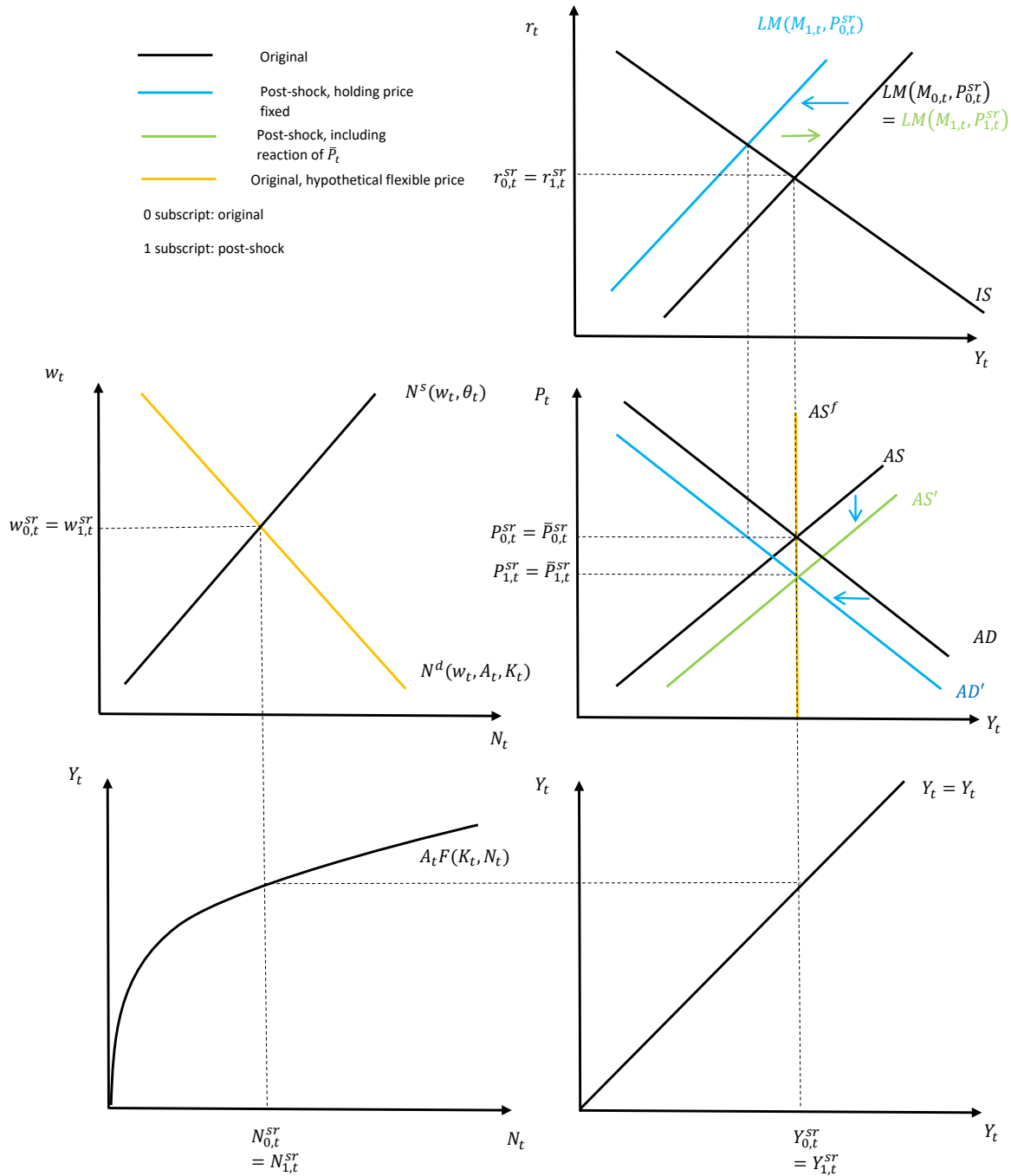

In a nutshell, if a central bank can effectively communicate its desire to lower the price level in advance, it may be able to do so without sacrificing any short run drop in output. It is sometimes said that there is the possibility of a “costless disinflation.” In other words, if successfully communicated to the public, there may be no distinction between the short run and the medium run, with the effects of price stickiness neutralized.

The possibility of costless disinflation rests on the assumption that private sector agents have well-formed expectations (in addition to the assumption that the central bank can credibly communicate its desire to lower the general level of prices to them). The “rational expectations” hypothesis holds that agents in an economy use all available information to make optimal forecasts of variables relevant to their current decision-making. Rational expectations does not mean that forecasts are always correct, though it does imply that forecasts are not systematically wrong. For example, if agents always expected an inflation rate of 2 percent, even though the actual inflation rate always turned out to be 4 percent, their forecasts would be systematically wrong, a violation of rational expectations. In contrast, if agents always expected an inflation rate of 2 percent, but the actual inflation rate was sometimes 3 percent and sometimes 1 percent (without any predictable reason why the inflation rate is high or low), but on average was 2 percent, expectations are rational.

The possibility of costless disinflation therefore rests on two assumptions: that expectations of inflation are fully rational and that the central bank can credibly communicate its desire to reduce the inflation rate to the public. This was evidently not the case during the Volcker disinflation of the early 1980s.

26.4 Summary

- There is no guarantee that the short run equilibrium of the New Keynesian model will coincide with the hypothetical equilibrium that would obtain if the price level were flexible. In other words, there is no guarantee that $Y_t = Y_t^f$. We sometimes refer to Y_t^f as “potential output” because this is the optimal level of output for the economy to produce (for a formal discussion of this point see Chapter 15). We refer to the term $Y_t - Y_t^f$ as the “output gap.”
- In the sticky price model a suboptimal equilibrium is one in which the would like to change its price but is unable to. As prices become flexible over a longer time horizon, the firm will adjust its price bringing the equilibrium to the equilibrium of the neoclassical model. For instance, if output is lower than its flexible level, firms have an incentive to reduce prices which shifts the economy to the neoclassical equilibrium. The intuition runs in the reverse direction if output is greater than its flexible price level.
- The Phillips curve is a generic name that applies to the relationship between some measure of real activity (e.g. the output gap) and the change in prices. The relationship between the output gap and inflation in post war US data is weakly positive. However, after 1984 the relationship is strongly positive and, contrary to the theory, is actually

weakly negative prior to 1984. Exceptionally volatile inflation expectations helps explain the anomalous behavior prior to 1984.

- If firms completely anticipate a change in money supply, they can respond by changing prices. Consequently, only unanticipated changes in the money supply affect the real economy.
- If every individual and firm has rational expectations and the central bank can credibly commit to its actions, it is possible for the central bank to reduce inflation without reducing output. This is known as “costless disinflation”.

Key Terms

- Output gap
- Phillips Curve
- Costless disinflation

Questions for Review

1. Suppose that you have a sticky wage model in which $Y_t < Y_t^f$. What does this imply about the real wage relative to where the household would like it to be? Given the chance to adjust its nominal wage, in which direction will the household change its nominal wage? What effect will this have on the position of the sticky wage AS curve?
2. Suppose that you have a sticky price model in which $Y_t > Y_t^f$. In this situation, is the firm hiring more or less labor than it would like to? What pressure does this put on the price level and output as the economy transitions to the medium run?
3. The original empirical Phillips Curve was based on correlations between wage inflation (the percentage change in the nominal wage over time) and the output gap. We have expressed things in terms of price inflation. If one takes the sticky wage New Keynesian model as the benchmark, what would the model predict about the correlation between the output gap and wage inflation?
4. Critically evaluate the following claim. “In the New Keynesian model, a central bank can increase output by increasing the money supply. Therefore, the central bank should increase the money supply by ever larger amounts each period. This will generate sustain increases in output.”

Exercises

1. Suppose the economy starts in the Neoclassical equilibrium and θ_t increases.
 - (a) Draw the dynamics in the sticky price case. Verbally describe what is going on.
 - (b) Draw the dynamics in the sticky wage case. Verbally describe what is going on.
2. Consider the basic sticky price New Keynesian model as presented in the text. Suppose that the economy is driven into a recession caused by an exogenous reduction in A_t .
 - (a) Graphically show the effects of the reduction in A_t on the endogenous variables of the model. Include in your graph what happens to the flexible price, neoclassical values of the endogenous variables.
 - (b) What pressure will there be on the position of the AS curve as the economy transitions from short run to medium run?
 - (c) An observer looking at data generated from this model will observe a particular correlation between inflation and output conditional on a shock to A_t . Is that correlation consistent with the idea of the Phillips Curve as presented in the text? What is missing from looking at a simple correlation between inflation and output when comparing it to the predictions of the Phillips Curve?
3. Consider a sticky price New Keynesian model. Suppose that the equations of the demand side are given as follows:

$$C_t = c_1(Y_t - G_t) + c_2(Y_{t+1} - G_{t+1}) - c_3r_t$$

$$I_t = -b_1(r_t + f_t) + b_2A_{t+1} - b_3K_t$$

$$M_t = P_t - m_1(r_t + \pi_{t+1}^e) + m_2Y_t$$

Here, c_1 , c_2 , and c_3 are positive parameters, as are b_1 , b_2 , b_3 and m_1 and m_2 . Government spending, G_t , is exogenous.

- (a) Derive an algebraic expression for the AD curve.
- (b) Find an expression for how Y_t will react to an increase in f_t when the price level is fixed at \bar{P}_t .

- (c) Solve for an expression for how much \bar{P}_t must adjust to keep Y_t fixed after an increase in f_t (as it would in the neoclassical model). Verify that the required increase in \bar{P}_t is positive.

Chapter 27

Monetary Policy in the New Keynesian Model

We have thus far taken monetary policy to be exogenous with respect to the model. That is, M_t is an exogenous variable. This allowed us to think about how exogenous changes in M_t might impact the endogenous variables of the model, but is not realistic in the sense that most changes in monetary policy are not exogenous, but are rather reactions to changes in economic conditions.

In this chapter, we study how monetary policy *ought* to be conducted in the New Keynesian model. We will focus on the partial sticky price model, which generalizes to the sticky price model when $\gamma = 0$. Appendix D also studies optimal monetary policy in the sticky wage New Keynesian model. In Chapter 21, it was argued that the neoclassical equilibrium is the efficient equilibrium allocation – a social planner could do no better than the private market left to its own devices. If the price level is sticky, in the short run, the equilibrium may not coincide with what it would be in the neoclassical model. In the medium run, pressures on the price level will naturally work to take the economy to the neoclassical, efficient, equilibrium. But how long does it take to go from the short run to the medium run? John Maynard Keynes famously said that “In the long run, we are all dead.” By this he meant that short run frictions (like price rigidity) which impede the efficient allocation of resources might last for a very long time, and that it is important for the fiscal or monetary authority to step in to try to restore an efficient equilibrium.

In a nutshell, optimal monetary policy in the New Keynesian model involves adjusting M_t (and hence interest rates) in response to other exogenous shocks so as to implement the hypothetical neoclassical equilibrium even when the price level is sticky. Mathematically, this means adjusting M_t such that $Y_t = Y_t^f$, where Y_t is the equilibrium level of output and Y_t^f is what output would be if the price level were flexible. Effectively, what this entails is adjusting monetary policy in response to other shocks so as to not wait for the medium run dynamic adjustment of prices to take over. As we will see below, this involves using monetary policy to *counteract* demand shocks (i.e. a positive IS shock should be countered by a contraction in the money supply and increase in interest rates) but using policy to *accommodate* supply shocks (i.e. an increase in A_t should be met by an increase in the money supply and a reduction in interest rates). We will also argue that a policy of inflation targeting will be

close to optimal provided fluctuations in \bar{P}_t are not very important.

A natural question that might come to mind is the following. If the equilibrium of the New Keynesian model is inefficient, why not also consider fiscal policy (which in a model with Ricardian Equivalence just means adjustment of government spending, although more generally could also mean the adjustment of tax policy)? There are a couple of reasons for not using fiscal policy, except in unusual circumstances. Most importantly, changes in fiscal instruments, while not affecting the hypothetical neoclassical level of output under our maintained assumptions about labor supply (see Appendix C for a situation in which this is not the case), do affect the distribution of that output among consumption and investment and affect the real interest rate which would obtain in the neoclassical model. Put differently, one could use changes in G_t (or G_{t+1}) to implement $Y_t = Y_t^f$, but the values of C_t and I_t would not be the same in the short run New Keynesian model as they would in the neoclassical model. We will return to this in more detail below in the section on the natural rate of interest. Another problem with fiscal policy is that it is associated with long legislative delays – by the time Congress can act, the underlying problem may have subsided. This is less of a problem with monetary policy, which can react to changes macroeconomic conditions rapidly.

27.1 Policy in the Partial Sticky Price Model

In this Chapter we focus on the partial sticky price model. The full set of equations describing the equilibrium are shown below:

$$C_t = C^d(Y_t - G_t, Y_{t+1} - G_{t+1}, r_t) \quad (27.1)$$

$$N_t = N^s(w_t, \theta_t) \quad (27.2)$$

$$P_t = \bar{P}_t + \gamma(Y_t - Y_t^f) \quad (27.3)$$

$$I_t = I^d(r_t, A_{t+1}, K_t) \quad (27.4)$$

$$Y_t = A_t F(K_t, N_t) \quad (27.5)$$

$$Y_t = C_t + I_t + G_t \quad (27.6)$$

$$M_t = P_t M^d(r_t + \pi_{t+1}^e, Y_t) \quad (27.7)$$

$$r_t = i_t - \pi_{t+1}^e \quad (27.8)$$

A graphical depiction of the equilibrium is presented in Figure 27.1 below. We assume that the economy initially sits in a short run equilibrium which coincides with the hypothetical flexible price equilibrium.

Figure 27.1: Equilibrium in the Partial Sticky Price Model

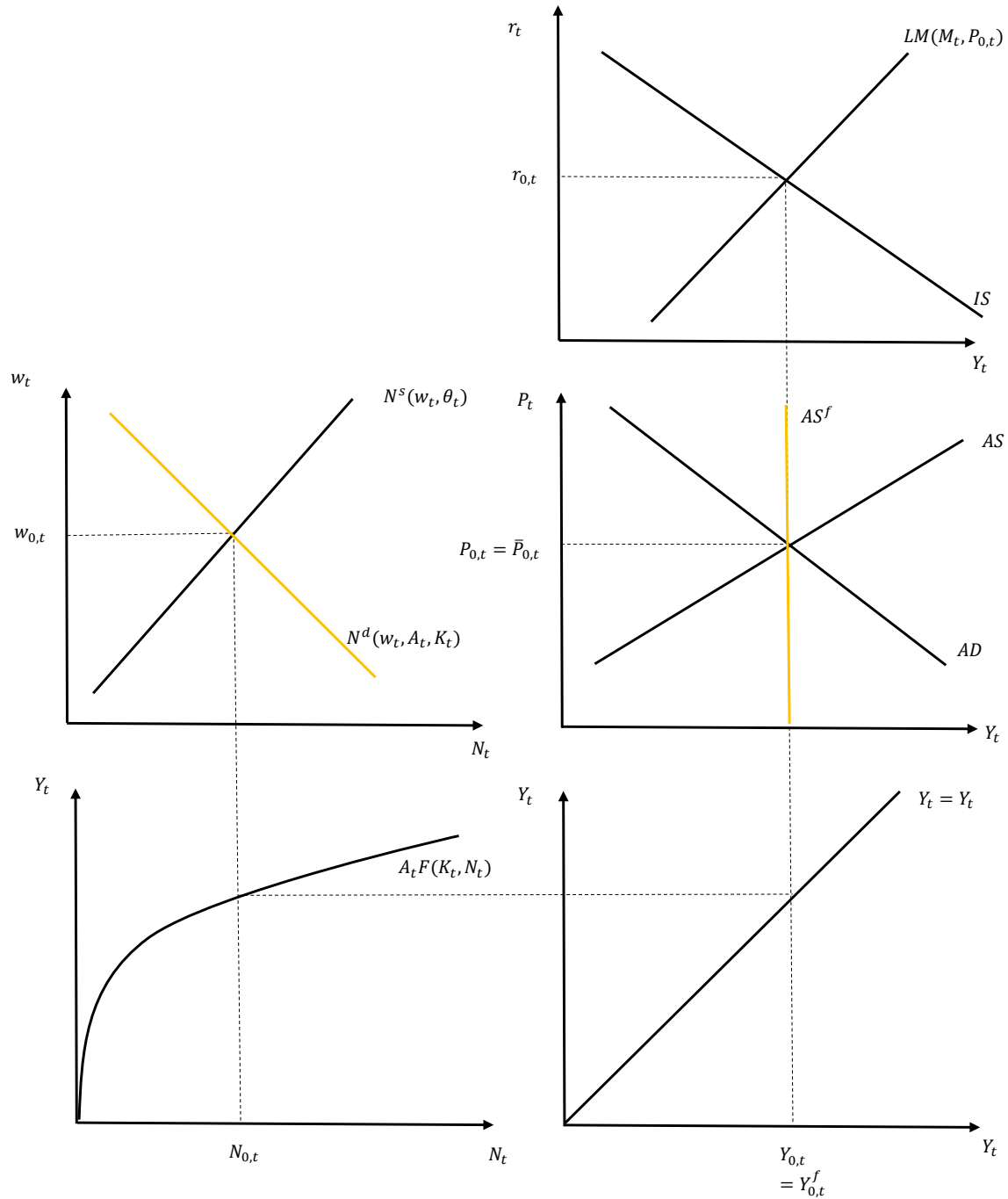

Now let us consider how monetary policy ought to adjust to different exogenous shocks so as to implement the neoclassical equilibrium in the short run. Consider first a shock which makes the IS curve shift to the right. This could be because of an increase in A_{t+1} or G_t , or a decrease in G_{t+1} . The initial equilibrium is depicted via black lines and labeled with a 0 subscript. The effects of the shock are shown in blue, and any indirect effect on the position

of the LM curve owing to a change in the price level is shown in green. 1 subscripts denote what the equilibrium would be in the short run with no policy response (i.e. with keeping the money supply fixed).

Figure 27.2: Optimal Monetary Response to Positive IS Shock

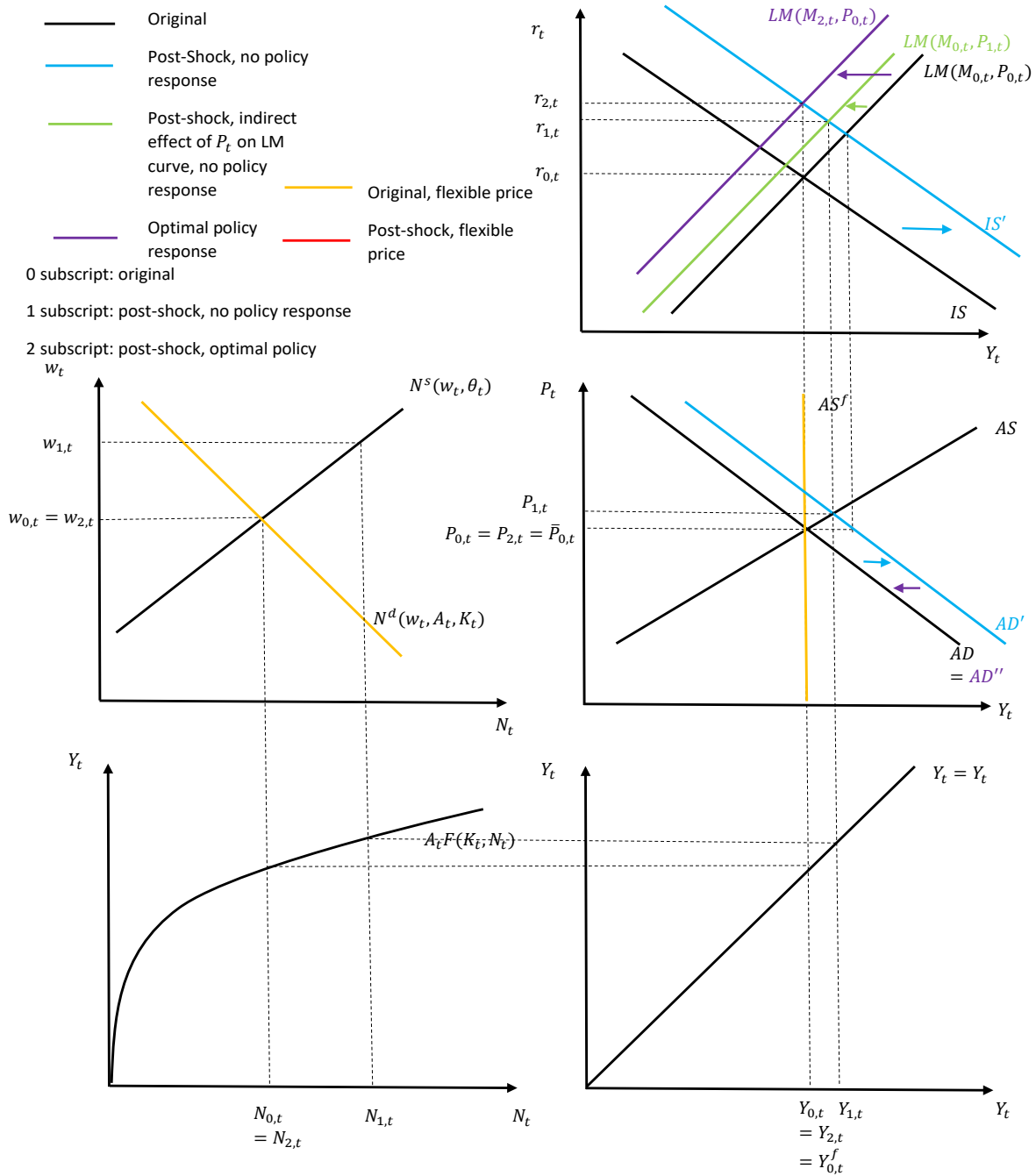

Absent any policy change, a positive IS shock would result in output rising, the price level rising, the real interest rate rising, and the real wage and labor input both rising. Since there

is no effect on Y_t^f , the output gap would be positive – the short run equilibrium features more output than is optimal. If monetary policy wanted to counteract this, it should change the money supply in such a way as to reduce output. This necessitates reducing the money supply, the effect of which would be to shift the LM curve in and the AD curve back in to where it started (shown in purple in the figure). If the change in M_t is sufficient to result in no net change in output (the 2 subscripts denote the short run equilibrium values with the optimal policy adjustment), then there will be no change in the price level, no change in labor input, and no change in the real wage. Relative to what would happen absent any policy change, the real interest rate would rise. Since $Y_{2,t} = Y_t^f$, there would be no pressure for \bar{P}_t to adjust and hence no dynamics from the short run to the medium run. We can therefore see that the optimal policy is to *counteract* the expansionary IS shock – the money supply should move opposite how output would move absent a policy change, and the real interest rate (and also the nominal rate, since we are treating expected inflation as an exogenous constant) would move in the same direction as output would move absent a policy change.

Consider next an exogenous increase in productivity, manifested in an increase in A_t . This is shown in Figure 27.3. The blue lines and 1 subscripts show what would happen in the short run absent any policy change. The AS curve would shift right, by a horizontal amount equal to the shift of the hypothetical vertical neoclassical AS curve, AS^f (the shift of which is shown in red). Output would rise, but by less than the neoclassical level of output. The price level and the real interest rate would fall. It is not possible to definitively sign the effects of an increase in A_t on labor market variables, though the figure is drawn where these both decrease.

Relatively to the neoclassical equilibrium, the short run equilibrium of the New Keynesian model features output under-reacting to the productivity improvement. Optimal policy would want to implement the neoclassical equilibrium, and therefore expansionary monetary policy is needed. The monetary authority should increase the money supply by an amount sufficient to shift the AD curve (shown in purple) such that it intersects the new AS curve (blue) at the new neoclassical AS curve (red). If this happens, there will be no resulting change in the price level. The real wage and labor input will both rise. The real interest rate will fall by more than it would if policy did not react to the shock.

Figure 27.3: Optimal Monetary Response to Increase in A_t

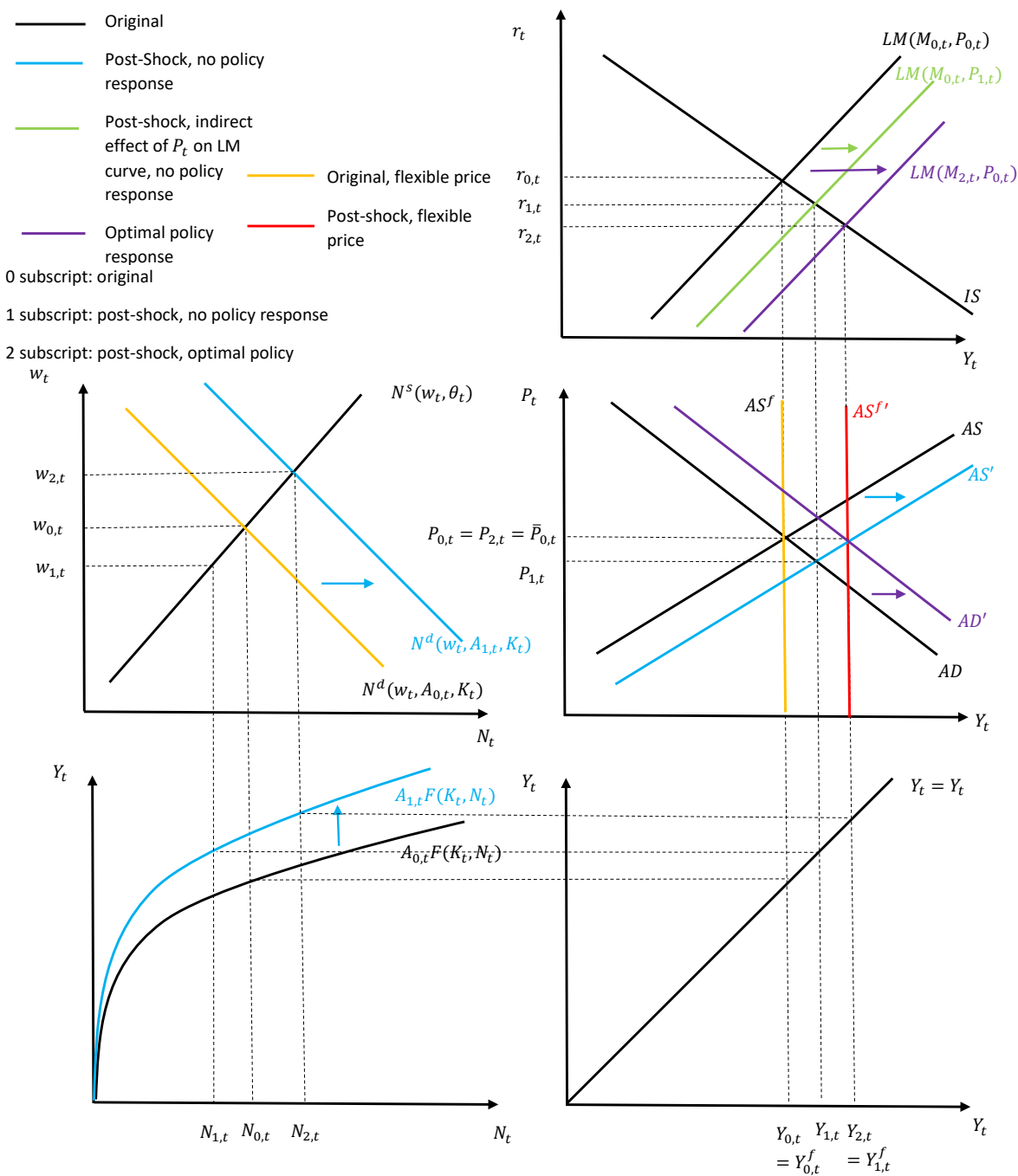

Next, let us consider an exogenous increase in the exogenous component of the price level, \bar{P}_t . One could think of this as an “expected inflation” shock, or perhaps as a shock to the price of materials input (e.g. the price of oil). This is shown in Figure 27.4 There is no effect of this shock in the neoclassical model. It causes the upward-sloping AS curve to shift up, crossing the hypothetical neoclassical AS curve at the unchanged neoclassical level

of output. If there is no policy change, output will decline and the price level will rise. To accommodate falling output, the real interest rate must rise, which is graphically achieved through an inward shift of the LM curve (shown in green) owing to the increase in the price level. The real wage and labor input must both fall.

If the monetary authority wishes to implement the neoclassical equilibrium level of output, it must engage in expansionary policy. It must increase the money supply so as to shift the AD curve out (purple), so that the new AD curve intersects the new AS curve at the unchanged neoclassical equilibrium level of output. In the new optimal policy equilibrium, the price level will be higher. The higher price level exactly offsets the higher money supply, so that the position of the LM curve is unaffected. Hence, there is no change in the real interest rate, nor any change in labor market variables.

Figure 27.4: Optimal Monetary Response to Increase in \bar{P}_t

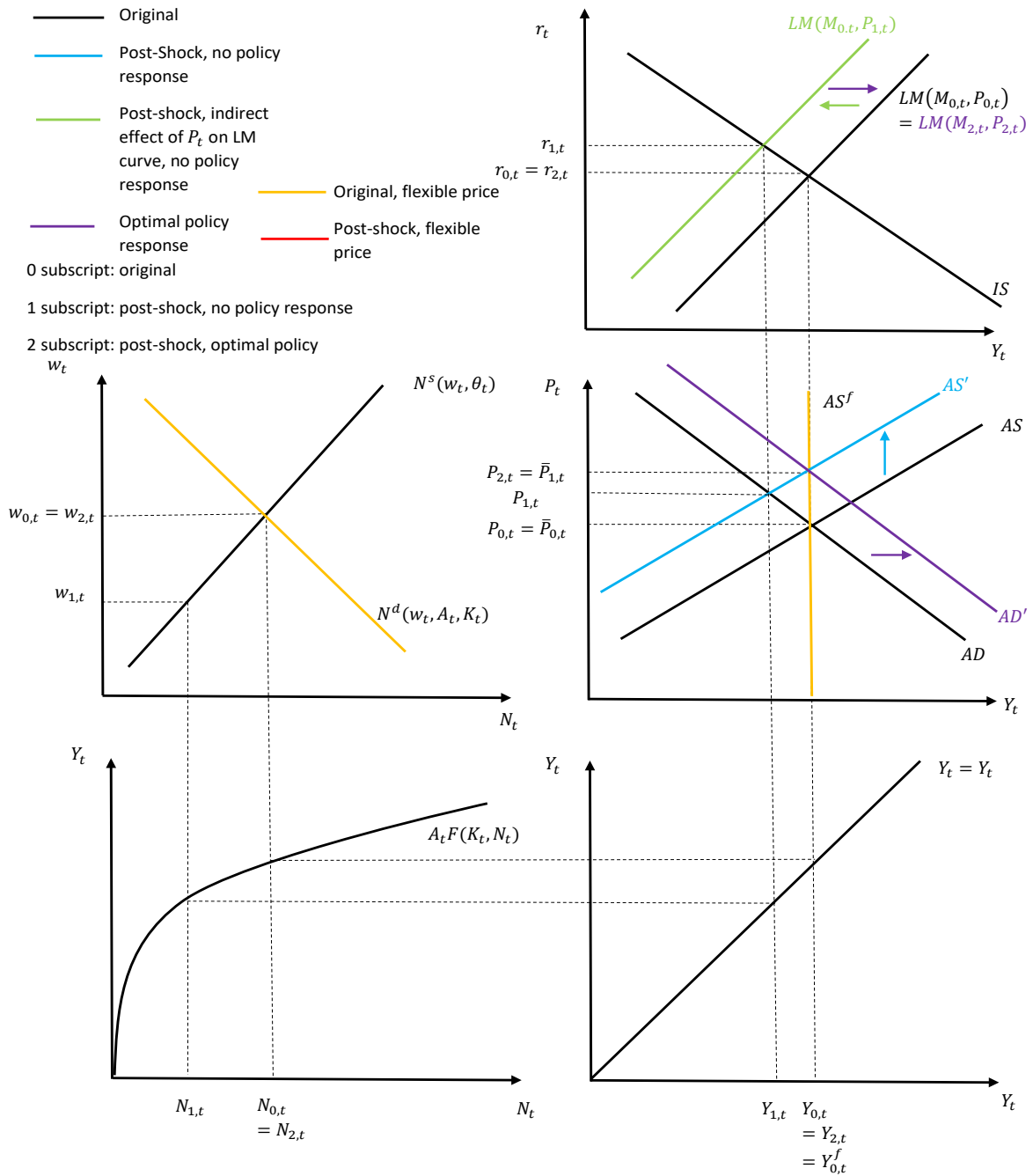

We leave a detailed analysis of the optimal policy response to an exogenous change in θ_t as an exercise. Table 27.1 shows the qualitative direction in which the money supply (and the real and nominal interest rates) ought to move in response to different exogenous shocks in the partial sticky price model. These directions are expressed relative to what would happen after a shock absent any policy change. This table would be the same for the simple sticky

price model as well.

Table 27.1: Optimal Monetary Policy Reaction to Different Shocks

Variable	Exogenous Shock		
	↑ IS curve	↑ A_t	↑ \bar{P}_t
M_t	-	+	+
r_t	+	-	-
i_t	+	-	-

Focusing on the first two inner columns of the table (the entries labeled “↑ IS curve” and “↑ A_t ”), we see that optimal monetary policy seeks to *counteract* IS shocks but to *accommodate* productivity shocks (the same would be true for exogenous changes in θ_t). By “counteract” we mean that policy should move the money supply *opposite* how output would react absent a policy change, and by “accommodate” we mean that the money supply should move in the *same* direction as how output would move absent a policy change. It is sometimes said that policy should counteract demand shocks (IS shocks) and accommodate supply shocks (changes in A_t or θ_t). This statement does not hold for the case of shocks to \bar{P}_t , where optimal policy would counteract these shocks. We discuss this in more detail in the section immediately below.

27.2 The Case for Price Stability

Many central banks around the world (including the Federal Reserve in the US) have as one of their stated goals (if not their *only* goal) “price stability.” In the US and other developed economies, price stability is typically interpreted as an inflation rate around 2 percent per year. It is common to refer to central banks with a price stability goal as following an *inflation target*.

From the perspective of the New Keynesian model, does price stability as a normative goal make sense? It turns out that the answer is yes, at least so long as fluctuations are not primarily driven by changes in \bar{P}_t . We can see this in the section above, where we analyzed the optimal monetary policy responses to positive IS shocks (Figure 27.2) and positive productivity shocks (Figure 27.3). In both cases, we see that in the new short run equilibrium with optimal monetary policy, the price level is unaffected by the IS or productivity shock. In other words, implementing optimal policy, which we have defined as adjusting the money supply in response to shocks so as to implement the hypothetical neoclassical equilibrium level of output, *implies* price stability. In other words, price stability is not the goal *per se*, but is an outcome of the implementation of optimal policy.

We can formally think about a central bank with a motivation for price stability as adjusting the money supply so that the price level is constant in equilibrium. This results in what we will call the *effective AD curve*, or AD^e , being horizontal. If the AD^e curve is horizontal at \bar{P}_t , then equilibrium output will equal the hypothetical, efficient neoclassical level. When thinking about the effective AD curve, we need not consider explicitly the LM curve. r_t is determined from the IS curve at the level of output where the AS and AD^e curves intersect. In the background, the central bank adjusts the money supply to make this happen. This is shown below in Figure 27.5:

Figure 27.5: A Strict Inflation (Price Level) Target and the Effective AD Curve

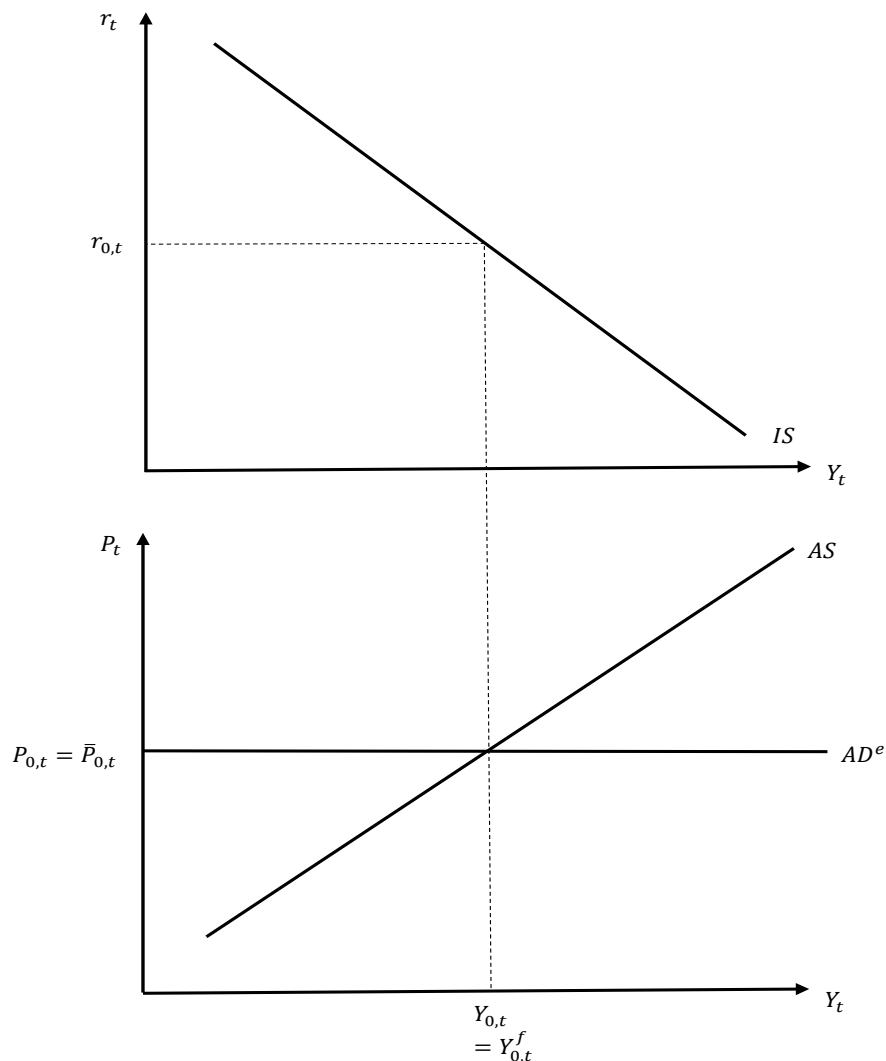

We can use these curves to think about how the economy will react to different exogenous shocks. Consider first a positive IS shock. This results in the IS curve shifting to the right. But if the AD^e curve is horizontal and its position solely determined by the central bank,

there is no shift in it and no change in equilibrium output or the price level. The real interest rate must rise given the new position of the IS curve for output to remain unchanged. This is shown in Figure 27.6 below:

Figure 27.6: A Strict Inflation (Price Level) Target: Response to Positive IS Shock

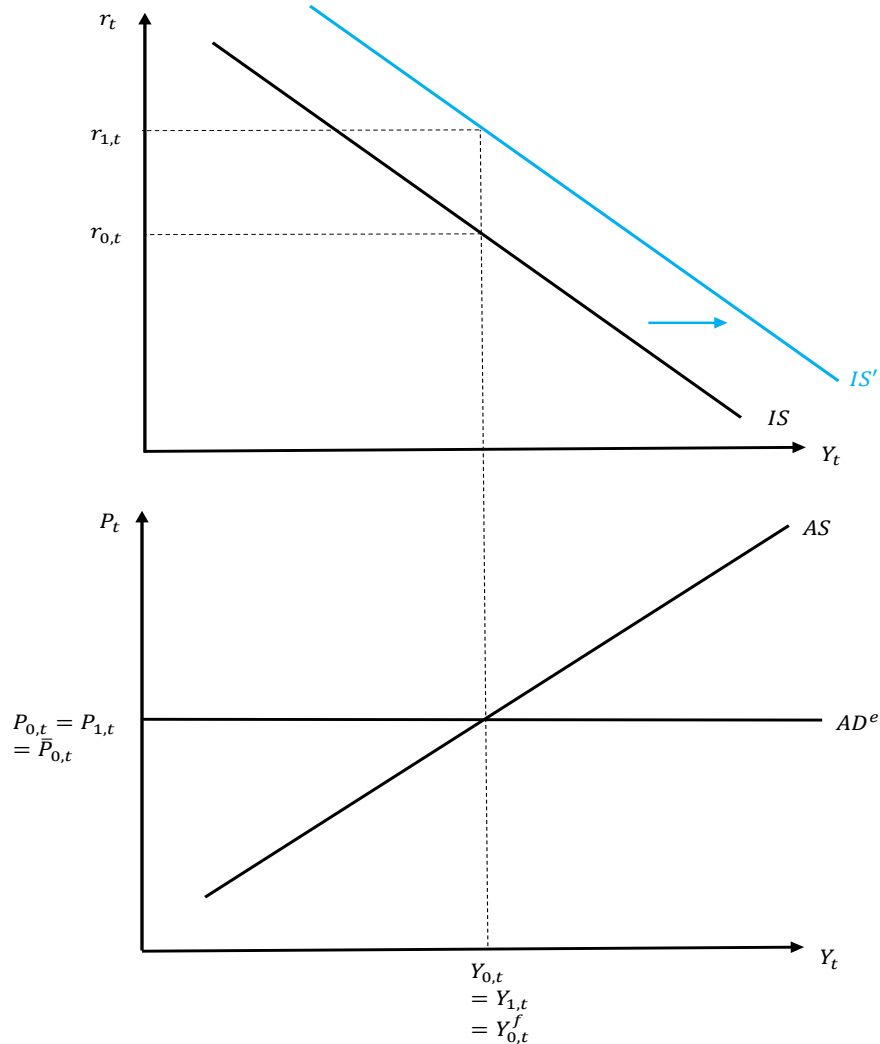

Consider next an increase in Y_t^f . This could be driven either by an increase in A_t or a reduction in θ_t . This is shown in Figure 27.7. The AS curve shifts to the right. With the AD^e curve being horizontal, output rises by the full amount of the change in Y_t^f and the price level is unaffected. The real interest rate must fall to support the higher level of output.

Figure 27.7: A Strict Inflation (Price Level) Target: Response to $\uparrow A_t$ or $\downarrow \theta_t$

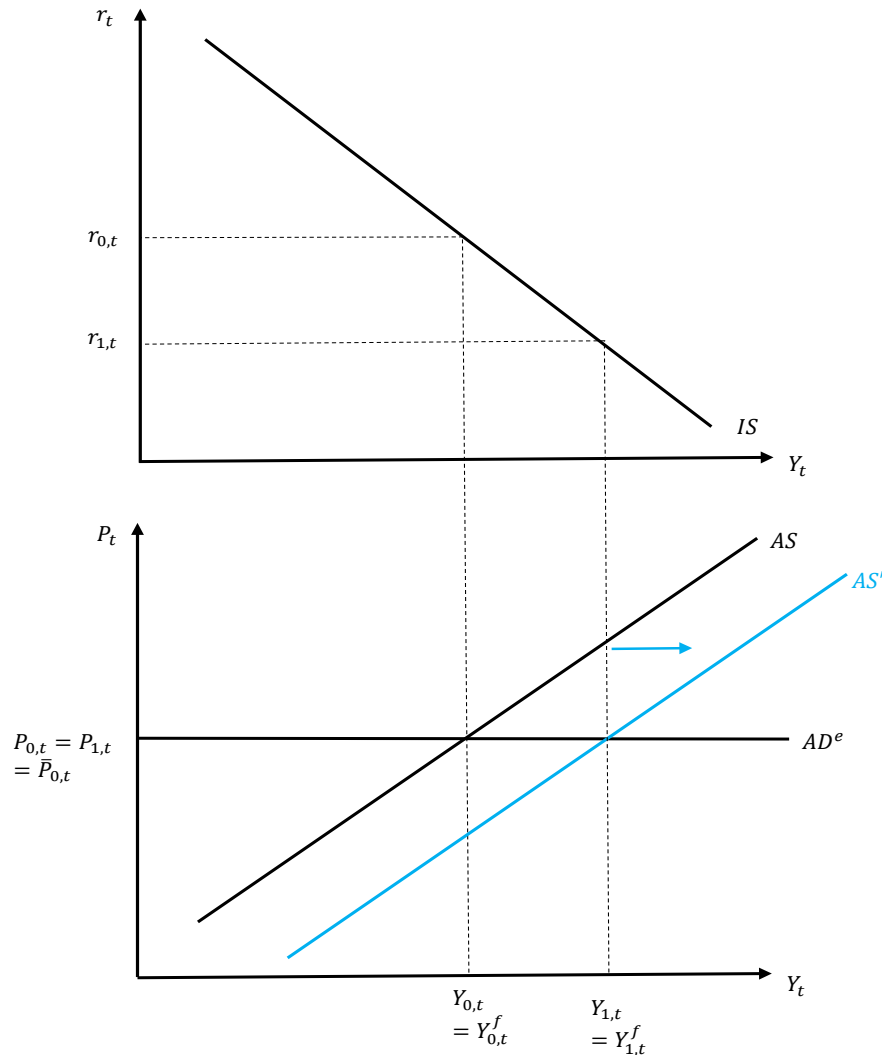

The analysis above reveals a critical point. If a central bank wants to implement the efficient equilibrium, it need only commit to price stability (and, in effect, cause the AD curve to become horizontal). Why is this a critical point? In reality, central banks may have difficulty in observing the exogenous shocks buffeting the economy in real time, and determining Y_t^f is no easy task in practice. Our analysis reveals that the central bank may not need to know what Y_t^f is, or what the actual exogenous shocks in the economy are, in order to achieve the efficient equilibrium. All it needs to do is to commit to price stability.

This is a rather remarkable result. It is so remarkable that [Blanchard and Galí \(2007\)](#) have called it the “Divine Coincidence.” The basic idea of the Divine Coincidence is that a central bank faces no tradeoff in achieving price stability and “full employment” (which in our model means $Y_t = Y_t^f$). Achieving one may automatically imply the other. Since Y_t^f is hard to determine, especially in real time, the Divine Coincidence implies that monetary

policy is relatively easy since fluctuations in the price level (or inflation rates) are much easier to observe at high frequencies and in real time.

Does the Divine Coincidence always hold in the New Keynesian model? Unfortunately, the answer turns out to be no. Conditional on IS shocks (demand) and shocks to A_t or θ_t (potential output shocks), the divine coincidence holds. Committing to stabilizing the price level automatically results in the efficient equilibrium outcome. But the Divine Coincidence does *not* hold conditional on shocks to \bar{P}_t . We have thought of changes in \bar{P}_t as primarily reflecting changes in expected rates of inflation, but more generally fluctuations in \bar{P}_t could reflect changes in the prices of important material inputs like oil. We can see this in Figure 27.8, which considers an exogenous increase in \bar{P}_t . If the central bank is committed to price stability, then the increase in \bar{P}_t necessitates a decline in output below potential, i.e. $Y_t < Y_t^f$.

Figure 27.8: A Strict Inflation (Price Level) Target: Response to $\uparrow \bar{P}_t$

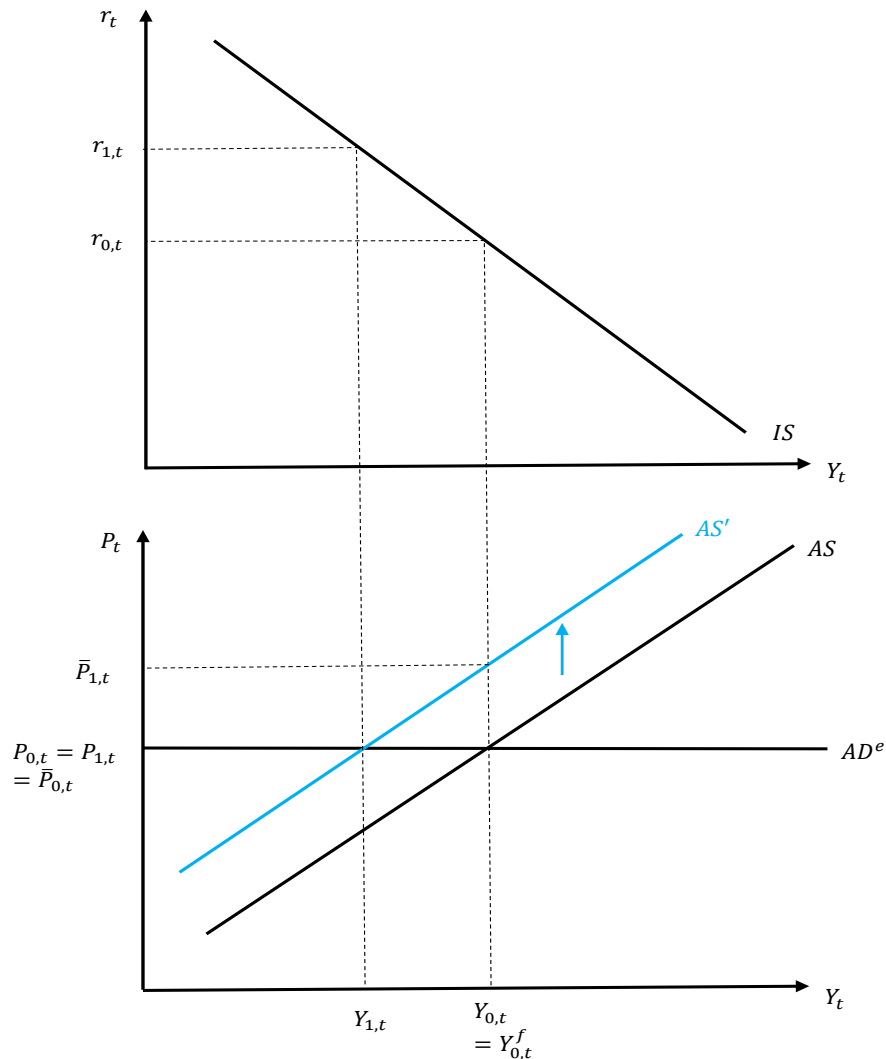

If in contrast, if the central bank tries to prevent output from declining in the face of an increase in \bar{P}_t , it must accept some inflation. The central bank cannot have its cake and eat it too conditional on \bar{P}_t shocks – it cannot simultaneously stabilize both prices and output.

Somewhat ironically, this analysis actually potentially strengthens the case for price stability. In particular, to the extent to which one thinks of \bar{P}_t as reflecting exogenous changes in expected inflation, then a central bank with a track record of achieving price stability is likely to face fewer and smaller fluctuations in \bar{P}_t . Hence, while a commitment to price stability may involve significant output costs when \bar{P}_t changes, a credible commitment to price stability likely means that those costs rarely have to be borne.

27.3 The Natural Rate of Interest and Monetary Policy

In the sections above, we have thought about monetary policy as in essence targeting $Y_t = Y_t^f$, where Y_t^f is the hypothetical neoclassical equilibrium level of output. For a fixed money supply, Y_t reacts differently to exogenous shocks than Y_t^f , and an optimizing central bank ought to adjust the money supply (and hence interest rates) to bring the two into alignment.

An alternative way to think about monetary policy is in terms of targeting interest rates rather than output. In particular, let r_t^f denote the “natural rate of interest,” or the real interest rate which would be the equilibrium real interest rate in the neoclassical model. The concept of the natural rate of interest was first developed by [Wicksell \(1898\)](#) and more recently popularized by [Woodford \(2003\)](#). In popular writings, the natural rate of interest is also sometimes called the “neutral” rate of interest or even sometimes (quite erroneously) the “equilibrium” rate of interest. The basic idea of optimal monetary policy can be cast in terms of adjusting r_t (through an adjustment of the money supply) so that $r_t = r_t^f$.

The natural rate of interest can be graphically determined by combining the vertical, hypothetical neoclassical AS curve (which gives Y_t^f) with the IS curve. This can be seen graphically below:

Figure 27.9: The Natural Rate of Interest

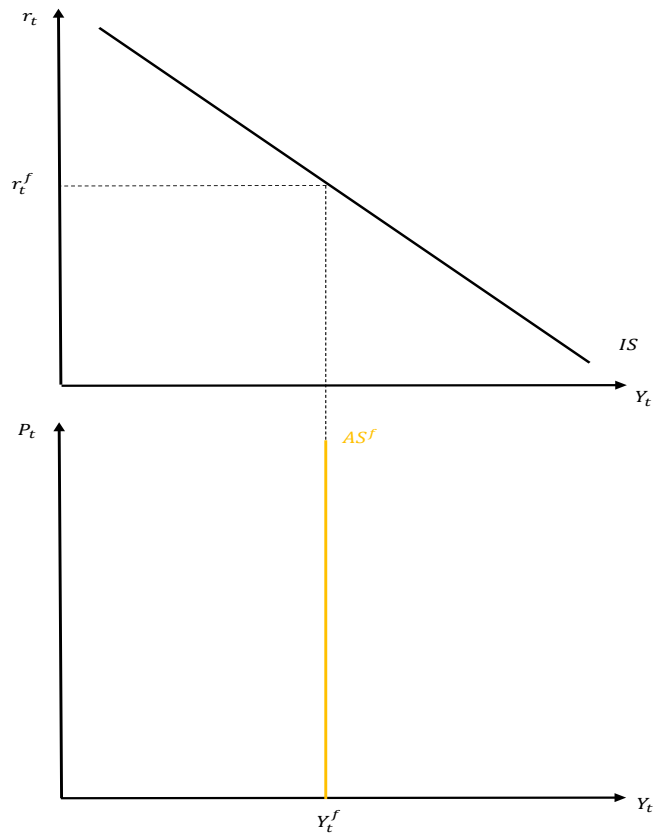

Mathematically, r_t^f is determined as the solution to the following expression:

$$Y_t^f = C(Y_t^f - G_t, Y_{t+1} - G_{t+1}, r_t^f) + I^d(r_t^f, A_{t+1}, K_t) + G_t \quad (27.9)$$

(27.9) is one equation in one unknown, r_t^f . Given exogenous variables and Y_t^f , one determines r_t^f as the solution to this equation. This is exactly what is shown graphically in Figure 27.9.

The natural rate of interest is affected by IS shocks and shocks to Y_t^f . In Figure 27.10, we show how a positive IS shock (e.g. an increase in A_{t+1} or G_t , or a reduction in G_{t+1}) impacts the natural rate of interest. The IS curve shifts right. But with no change in Y_t^f , the natural rate of interest rises by the amount of the vertical shift of the IS curve. The natural rate of interest would fall in response to a negative IS shock.

Figure 27.10: IS Shocks and the Natural Rate of Interest

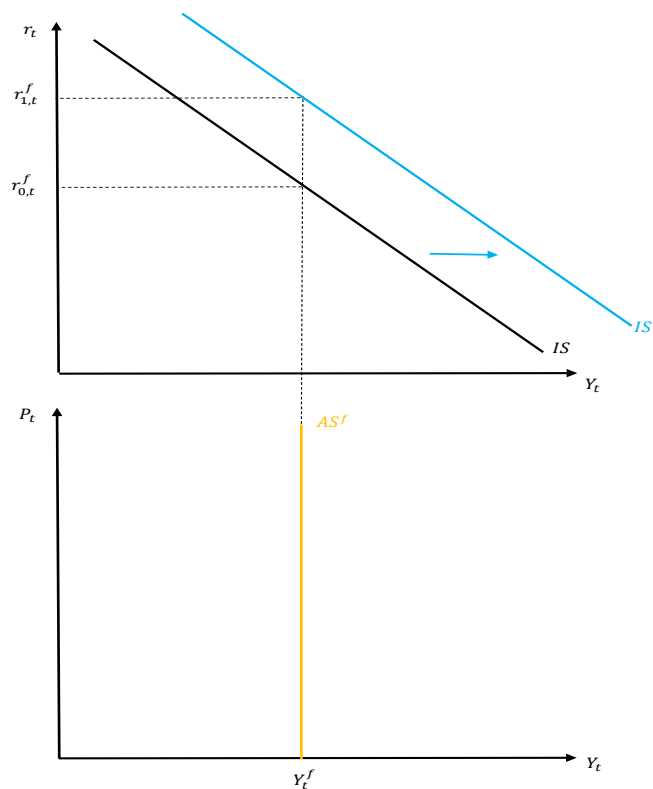

Consider next a positive shock to Y_t^f , which could occur because of an increase in A_t or a reduction in θ_t . There is no shift of the IS curve. But with Y_t^f higher, r_t^f must fall. This is shown below in Figure 27.11.

Figure 27.11: Y_t^f Shocks and the Natural Rate of Interest

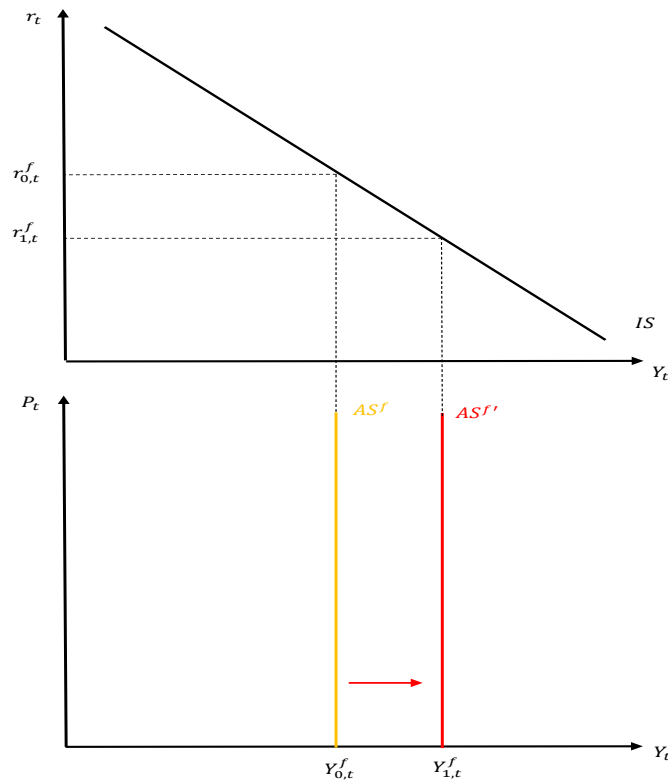

As we have seen, implementation of optimal policy requires targeting $Y_t = Y_t^f$, which implies targeting $r_t = r_t^f$. Though we have heretofore thought of policy in terms of adjustments in M_t , it is just as easy to think about the central bank as adjusting the interest rate (technically, central banks can only impact nominal rates, but to the extent to which expected inflation is constant, movements in the nominal and real rates are the same). In particular, we can think of optimal policy as targeting $r_t = r_t^f$. To see how the money supply must adjust to hit this target, consider the mathematical expression for the LM curve:

$$\frac{M_t}{P_t} = M^d(r_t^f + \pi_{t+1}^e, Y_t^f) \quad (27.10)$$

Taking r_t^f and Y_t^f as given, we can think of optimal policy as choosing M_t to make (27.10) hold. In particular, suppose that there is a positive IS shock. This raises r_t^f but has no effect on Y_t^f . This makes the demand for money (the right hand side of the equation) fall. To accommodate this demand for money, the central bank ought to reduce the money supply in such a way that $\frac{M_t}{P_t}$ falls to meet the fall in the right hand side without P_t changing. Similarly, suppose that there is a positive shock to, say, A_t . This causes Y_t^f to increase and r_t^f to decline, the combined effect of which is to increase the demand for money. The central bank

ought to increase the money supply so as to accommodate this increase in the demand for money without the price level changing.

The above analysis helps us to understand why most economists do not favor using fiscal policy as a stabilization tool, except perhaps in unusual circumstances to be discussed later. One reason that economists favor monetary over fiscal policy is outside of the confines of our model: with fiscal policy, there are long legislative lags and it takes a while to get things done. In contrast, monetary policy can react quickly to shocks. Furthermore, monetary policy makers are experts in the economy, whereas the same is not necessarily true of members of legislatures. The other reason, related to our discussion above, is that changes in fiscal variables (e.g. G_t) impact r_t^f . Changes in the money supply, in contrast, do not. It is therefore a well-defined thought experiment to adjust M_t to make (27.10) hold, since changes in M_t affect neither r_t^f nor Y_t^f . The same is not true in general for fiscal policy. As a trivial example, as can be seen in Figure 27.10, an increase in G_t raises r_t^f , even if it has no effect on Y_t^f .

This means that, in the context of the New Keynesian model, fiscal variables (like G_t) should not be used to combat shocks. As an example, suppose that the economy is hit with a positive IS shock (say people are more optimistic about the future, and A_{t+1} increases). G_t can be deployed to ensure that Y_t does not rise above Y_t^f , but this requires leaving the real interest rate unchanged. This can be seen in Figure 27.12 below. There we consider the effects of a positive IS shock in the partial sticky price model, and engage in the thought experiment of counteracting this with a change in G_t so as to keep $Y_t = Y_t^f$. The positive IS shock raises r_t^f even though there is no effect on Y_t^f . Using fiscal policy to make $Y_t = Y_t^f$ would necessitate reducing G_t , which would shift the IS and AD curves back in to their original positions. But this would entail no change in the equilibrium real interest rate, which would mean that, even though $Y_t = Y_t^f$, r_t would be less than what it would be in the neoclassical model with no policy response (which in the graph is labeled $r_{1,t}^f$). This means that using fiscal policy to combat the IS shock would result in the output gap being zero, but would affect the *composition* of output (between consumption, investment, and government spending) relative to the efficient, neoclassical equilibrium.

Figure 27.12: Using Fiscal Policy to Combat an IS Shock

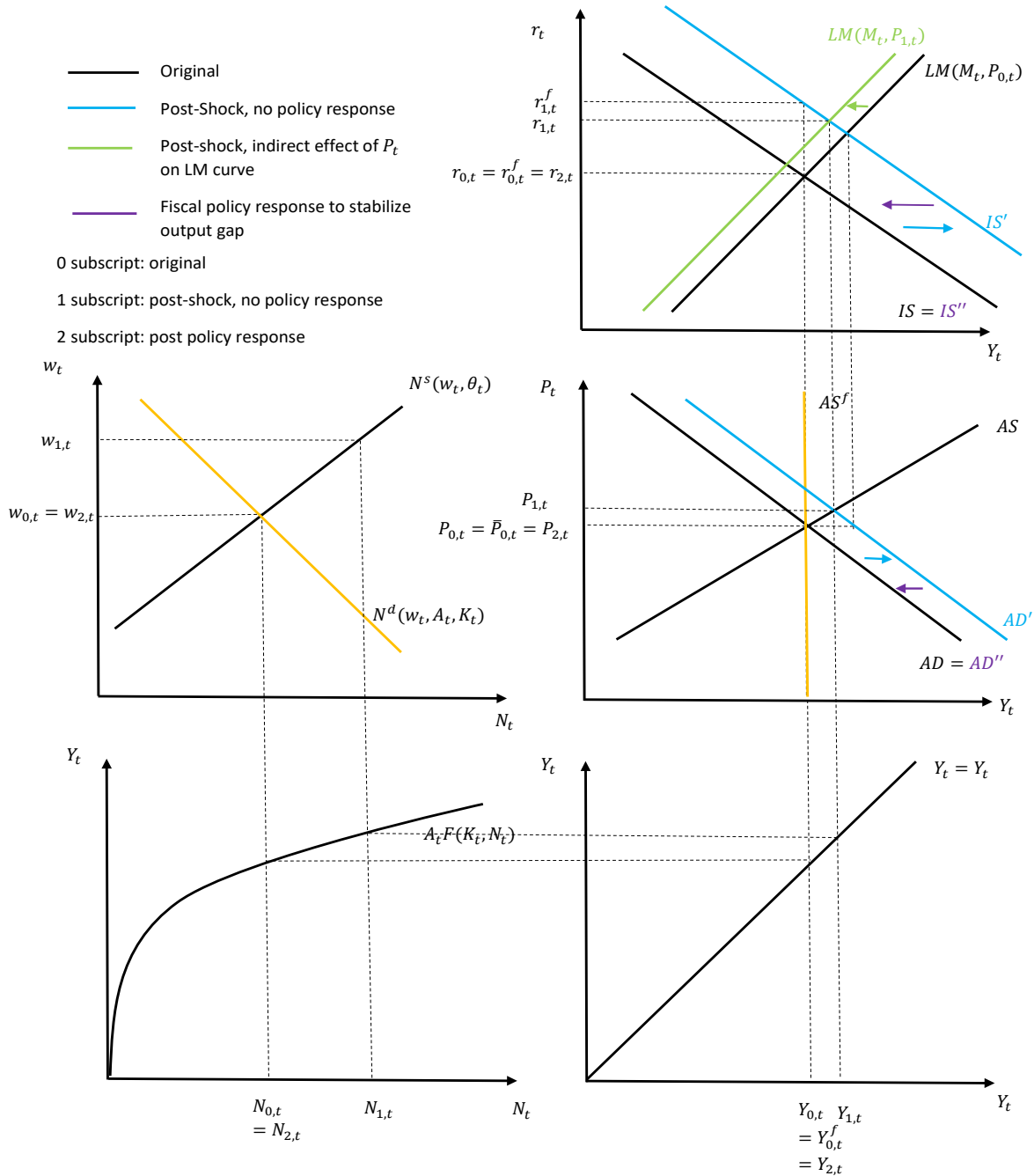

27.4 The Taylor Rule

We have thought about monetary policy as being conducted in terms of setting the money supply, M_t . We initially thought about M_t being exogenous, and in this chapter we have discussed how M_t ought to adjust in response to different exogenous shocks so as to implement

the neoclassical equilibrium.

There are a couple of potential drawbacks of this approach. First, modern monetary policy is typically conducted via targeting a short term nominal interest rate (like the Fed Funds Rate in the US), not the money supply. This is perhaps not such a big problem, because changes in M_t are what bring about changes in the target nominal interest rate and hence real interest rates, as we have seen. Second, while one can think about optimal monetary policy in terms of adjusting M_t in response to different shocks, it is not very transparent how this is done and a central bank behaving in this way has a lot of discretion.

For these reasons, many economists now think about monetary policy in the form of explicit rules relating target values of economic variables to a central bank's policy interest rate. The most famous monetary policy rule is attributed to John Taylor, [Taylor \(1993\)](#), and is often simply called the "Taylor Rule." Taylor posited that the Federal Reserve's target nominal interest rate equals the long run real interest rate, r^* , plus a long run inflation target, π^* , and responds positively to deviations of the actual inflation rate from target and to the output gap. The response coefficients ϕ_π and ϕ_y are both assumed to be positive. Formally, we can express this type of monetary policy rule as:

$$i_t = r^* + \pi^* + \phi_\pi(\pi_t - \pi^*) + \phi_y(Y_t - Y_t^f) \quad (27.11)$$

Suppose that the long run target real interest rate is $r^* = 2.5$ and the long run inflation target is $\pi^* = 2$. Taylor proposed coefficient values of $\phi_\pi = 1.5$ and $\phi_y = 0.5$. [Figure 27.13](#) below plots the actual Fed Funds Rate (black line) and the rate implied by (27.11) with these coefficients for the period 1984q1 through 2008q3. We omit the period prior to 1984 because of a large switch in the conduct of monetary policy occurring in the mid-1980s, and omit the period after 2008 because the actual Federal Funds rate has been at or near zero ever since.

Figure 27.13: Actual and Monetary Policy Rule Implied Fed Funds Rate

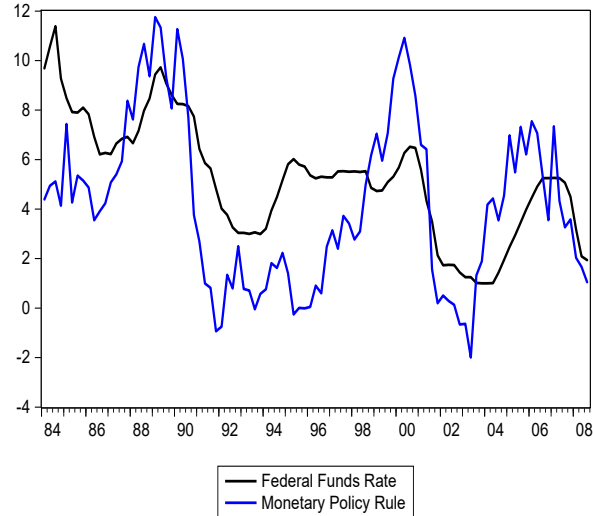

One can observe that, at least qualitatively, (27.11) provides a fairly good description of actual Fed policy. The correlation between the actual Funds rate and the rate implied by (27.11) is about 0.6. The two series can be made to look much more similar if one incorporates an interest-smoothing motive into the policy rule by including a lagged nominal interest rate term on the right hand side (i.e. something like ρi_{t-1} , where $0 < \rho < 1$).

It turns out that a monetary policy rule like the Taylor rule implies similar policy actions to what we have argued are optimal in the text. In particular, in the Taylor rule the Fed reacts to positive demand shocks by raising interest rates (which implies reducing the money supply) and to positive supply shocks by cutting interest rates (which involves increasing the supply of money). One can formally incorporate a policy rule like (27.11) into our model. This effectively involves replacing the LM curve (which treats the money supply as exogenous) with something like (27.11). The model can be graphically analyzed and has very similar implications to what we have studied in the text. This version of the model, which we call the IS-MP-AD-AS model, is presented and studied in Appendix E.

Chapter 28

The Zero Lower Bound

In Chapter 27, we discussed how a central bank can optimally adjust the money supply (and hence interest rates) in response to changing economic conditions. The basic idea of optimal policy is that a central bank wants to use its control of the money supply to impact the position of the AD curve in such a way that the short run equilibrium of the New Keynesian model coincides with the hypothetical equilibrium which would emerge in the medium run neoclassical model. Provided fluctuations in \bar{P}_t are not a major source of fluctuations, one way to think about this is that the central bank desires for the effective AD curve to become horizontal, which coincides with a policy of price stability.

A practical problem with this approach to policy that is particularly relevant of late is that nominal interest rates cannot go below zero (or cannot go very far below zero). Why is this? The nominal interest rate is the return on holding money across time. If you save one unit of money, you get back $1 + i_t$ units of money in the next period. Since money is storable across time (one of the functions which defines money is that it is a store of value), one should never accept a negative nominal return. Why? Suppose that the nominal interest rate is -5 percent. Putting one unit of money in the bank would yield 0.95 units of money in the next period. The outside option is simply to hold the money on your own, which would yield one unit of money in the future. Only if the nominal interest rate is positive is there a disincentive to hold money and put it in interest bearing bonds or bank accounts. Note that the real interest rate, in contrast, can be negative. Because of the non-storability of goods, one might accept a negative rate of return – i.e. you may give up a unit of goods today in exchange for 0.95 goods in the future if your outside option is to have zero units of the good in the future. But because money is storable, one ought to not be willing to accept a negative nominal return.

We can see the effects of the zero lower bound by referencing back to the first order condition for the holding of money we derived in Chapter 14. It is:

$$v' \left(\frac{M_t}{P_t} \right) = \frac{i_t}{1 + i_t} u_C(C_t, 1 - N_t) \quad (28.1)$$

In (28.1), if $i_t = 0$, then the only way for this expression to hold is if $\frac{M_t}{P_t} \rightarrow \infty$, which in

turn drives the marginal utility of holding money to zero. In other words, if the nominal interest rate goes to zero, there is an infinite demand for real money balances. For this reason, the nominal interest rate going to zero is sometimes called a “liquidity trap” – when the nominal interest rate is zero, there is an infinite demand for money (i.e. liquidity) relative to less liquid, interest-bearing assets. We can see from (28.1) that this first order condition cannot hold if $i_t < 0$ – this would require that the marginal utility of real balances or of consumption must be negative, which is inconsistent with the assumptions we have made on those functions. In other words, $i_t < 0$ is inconsistent with this equation holding. $i_t = 0$ is therefore a lower bound on the nominal interest rate. We refer to this as the “zero lower bound” and abbreviate it ZLB.

Until very recently, conventional wisdom among economists was consistent with what has been laid out here – nominal interest rates cannot go negative. Recently, several central banks around the world – including several central banks in Europe and Japan – have experimented with negative interest rates, and there have been calls from some for the US Federal Reserve to follow suit. Contrary to the predictions of our simple theory, embodied in the money demand specification (28.1), the demand for liquidity has not gone to infinity in those areas with negative nominal interest rates. Why not? Our modeling assumptions abstract from the fact that it is probably costly to hold liquidity. To use a literal example, suppose that holding money means stuffing it under one’s mattress. Surely there is some inconvenience associated with this (as well as a heightened probability of theft), and individuals may be willing to tolerate slightly negative nominal interest rates in exchange for not having to store all of their wealth under their mattress. There is likely *some* lower bound on nominal interest rates below which individuals would have an infinite demand for liquidity. It just may not be exactly zero. Since central banks experimenting with negative nominal interest rates have not lowered interest rates that far below zero, we don’t really know what that lower bound might be. Some economists prefer the term *effective lower bound* (ELB) rather the ZLB.

In what follows, we will assume that zero is in fact the lower bound on nominal interest rates. For the analysis which we do, it is actually not crucial that the lower bound is zero, just that there is some lower bound. What matters for our analysis is not so much that the nominal interest rate gets stuck at some particular point, but rather that the nominal interest rate becomes fixed at that point. Whether that invariant nominal interest rate is zero or slightly negative is not that important.

As we show in the subsections below, the ZLB introduces a flat portion to the LM curve. Most of the time, this flat portion of the LM curve is irrelevant, and the analysis of the New Keynesian model conducted in previous chapters is unaffected. But if the economy ventures into the flat portion of the LM curve, the AD curve becomes vertical. This means that output

becomes completely demand determined, which is a 180 degree change from the neoclassical model where output is completely supply determined. Furthermore, the real interest rate becomes constant when the ZLB binds. This will mean that shocks to the IS curve will have particularly large impacts on aggregate demand and total output. Furthermore, a binding ZLB could result in a deflationary spiral wherein the economy gets “trapped” at a suboptimally low level of output, where the economy’s supply-driven self-correcting mechanism does not work.

A binding ZLB has important implications for policy. First, it opens the door for the potential desirability of fiscal stimulus. This is because fiscal stimulus does not impact the real interest rate if the ZLB binds, which means that it does not crowd out private expenditure. Second, normal monetary policy will not work at the ZLB – the central bank cannot adjust interest rates in response to shocks since the interest rate becomes fixed. Exiting the ZLB can be difficult to engineer, and central banks will in general try to avoid ever hitting the ZLB in the first place. We conclude the chapter with a discussion of the tradeoffs involved in trying to design policies to avoid the ZLB.

28.1 The IS-LM-AD Curves with the ZLB

Given an exogenous amount of expected inflation, we can think about the ZLB as imposing a lower bound on the real interest rate. From the Fisher relationship, since $r_t = i_t - \pi_{t+1}^e$, $i_t \geq 0$ means that $r_t \geq -\pi_{t+1}^e$. Since expected inflation can be positive, the lower bound on the real interest rate can be negative.

In the upper panel of Figure 28.1, we plot the conventional LM curve, which is upward-sloping in a graph with r_t on the vertical axis and Y_t on the horizontal axis. Along with this, we plot a dashed line corresponding to the implied lower bound on the real interest rate of $-\pi_{t+1}^e$ (where again we take expected inflation to be exogenous.)

Figure 28.1: The LM Curve and the ZLB

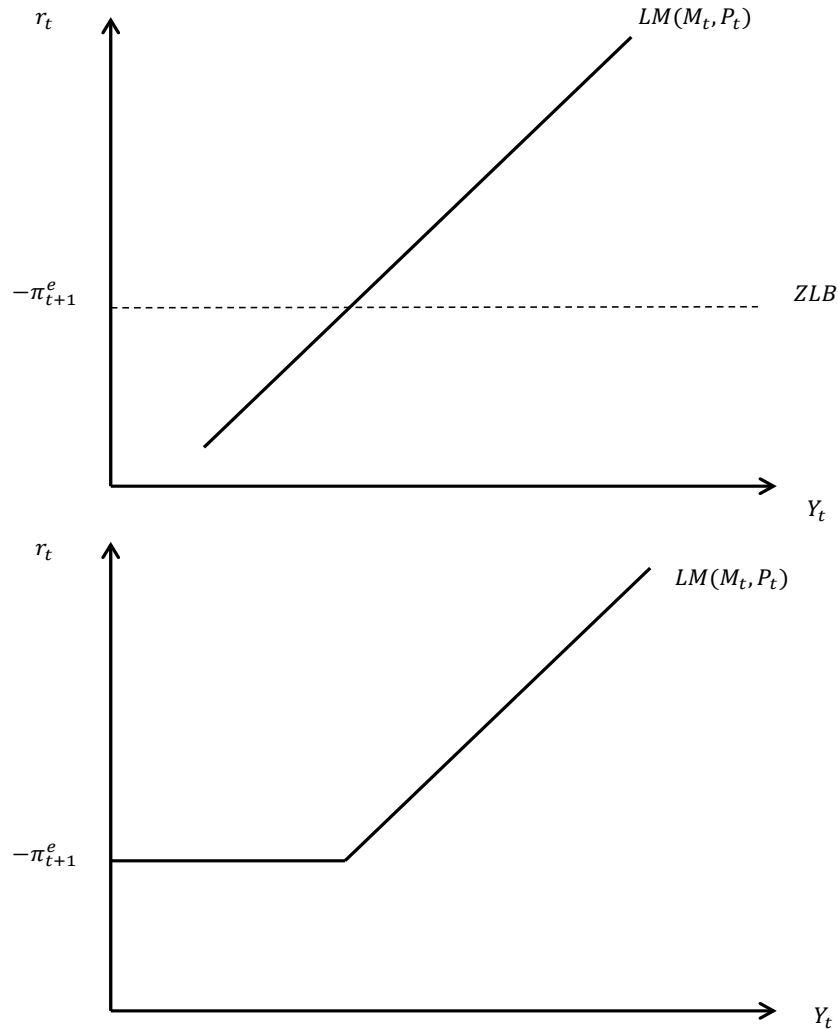

The effective LM curve is the upper bound of the conventional LM curve and the dashed line corresponding to the ZLB. In other words, the ZLB introduces a kink into the LM curve. For $r_t > -\pi_{t+1}^e$, the LM curve looks normal. For $r_t < -\pi_{t+1}^e$, the effective LM curve is a horizontal line at $r_t = -\pi_{t+1}^e$. This is shown in the lower panel of Figure 28.1.

How does one go from the effective LM curve (with the kink at $r_t = -\pi_{t+1}^e$) to the AD curve? We will first consider three different cases, one in which the ZLB is “non-binding,” one in which it always “binds,” and one in which it sometimes binds and sometimes does not. The first is for a “non-binding” ZLB. By this we mean that the IS curve is sufficiently far to the right that we need not worry about the ZLB binding. This case is considered in Figure 28.2 below. We proceed in the normal way. An increase in the price level causes the LM curve to shift in, which results in a higher real interest rate and hence lower output along the IS curve. Hence, the AD curve slopes down, just as it did before.

Figure 28.2: AD Derivation with a Non-Binding ZLB

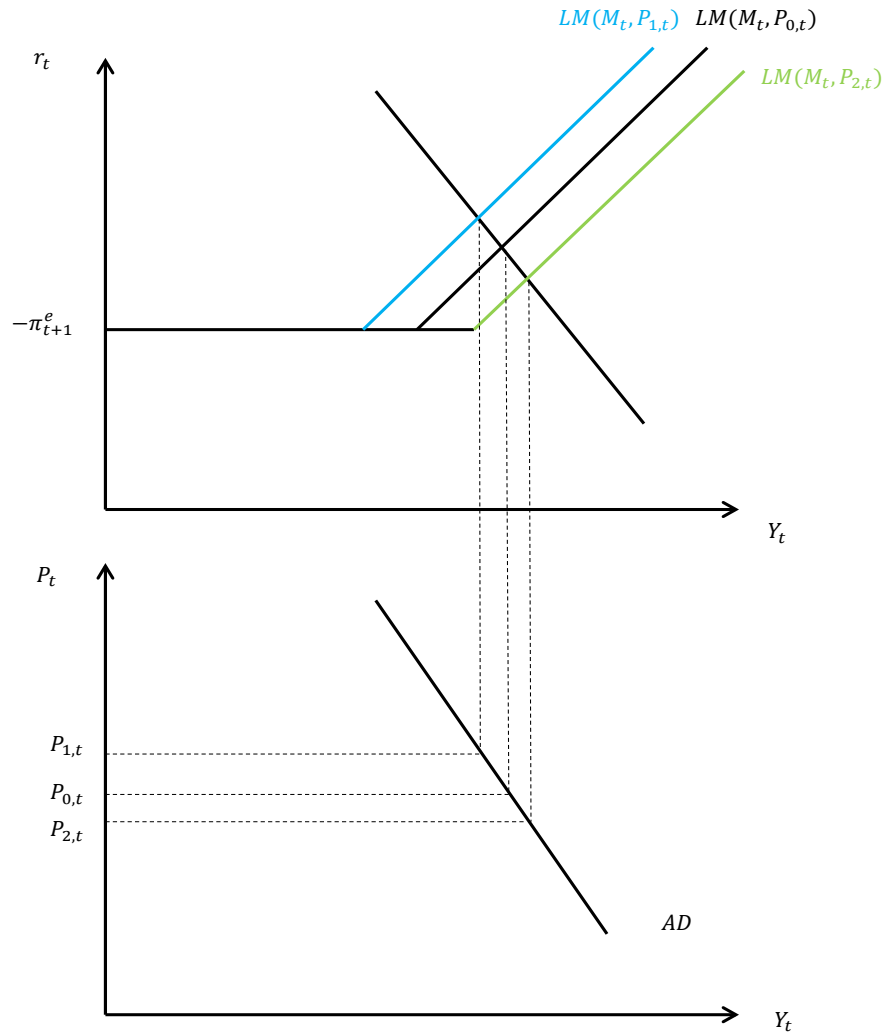

Next, we consider the case of a binding ZLB. This case is considered graphically in Figure 28.3. By binding ZLB we mean that the position of the IS curve is such that it intersects the effective LM curve in the flat region at $r_t = -\pi_{t+1}^e$. An increase in the price level causes the upward-sloping portion of the LM curve to shift in, but does not affect the flat portion of the effective LM curve. As long as the change in the price level is not so large as to shift upward-sloping portion of the LM curve in to the point where the IS curve would intersect it above $r_t = -\pi_{t+1}^e$ (which we rule out for the purposes of these exercises), the change in the price level has no impact on the real interest rate (it is effectively fixed), and hence no effect on Y_t . Put slightly differently, the IS curve is one equation in two unknowns – Y_t and r_t . But at the ZLB, r_t effectively becomes exogenous. This means that output is determined solely from the IS curve, and P_t does not affect the IS curve. This means that the AD curve becomes vertical.

Figure 28.3: AD Derivation with a Binding ZLB

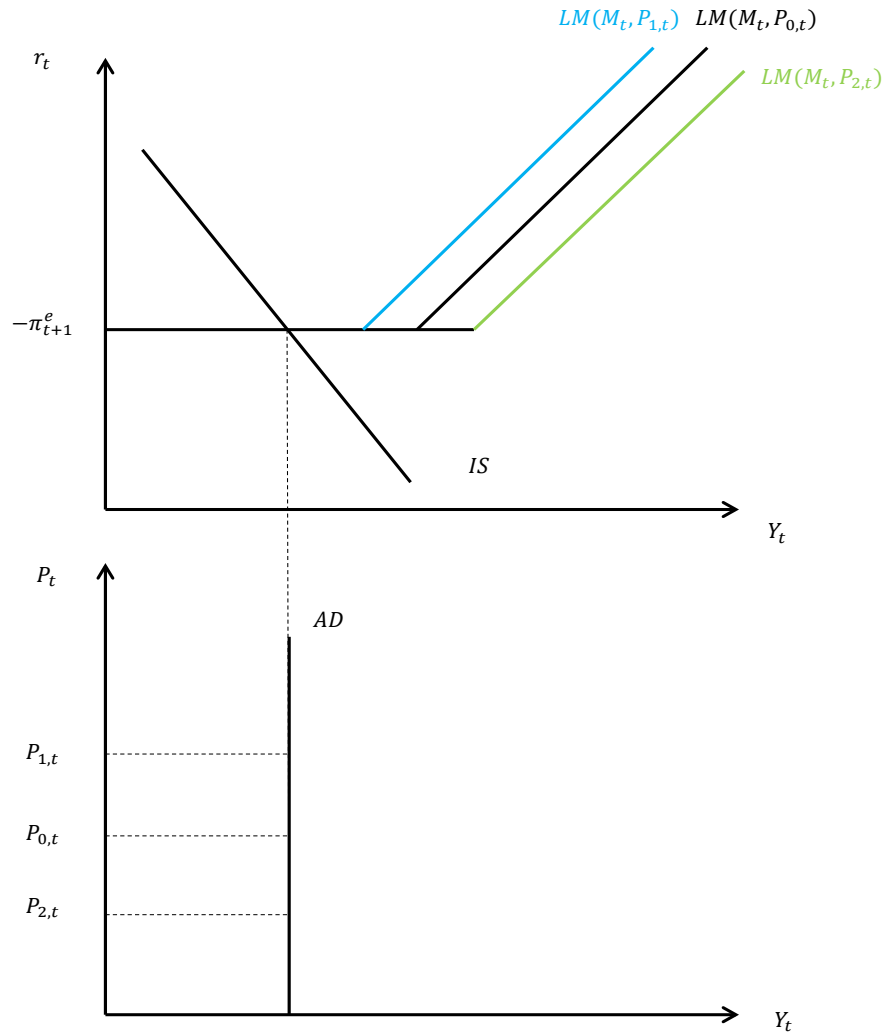

Finally, we consider the case where sometimes the ZLB binds and sometimes it does not. This is shown in Figure 28.4. With the price level sufficiently high, the upward-sloping portion of the LM curve is sufficiently far to the left that it intersects the IS curve above the lower bound on the real interest rate. In this region, the AD curve is downward-sloping as it ordinarily is. When the price level is sufficiently low, in contrast, the LM curve is sufficiently far to the right that the IS curve intersects the lower bound on the real interest rate before hitting the upward-sloping portion of the LM curve. In this region, the AD curve is vertical. Hence, we can think of the ZLB as introducing a kink into the AD curve – below some cutoff price level, the AD curve is vertical. Note that the ZLB is most likely to bind when the price level is low.

Figure 28.4: AD Derivation with Both a Binding and Non-Binding ZLB

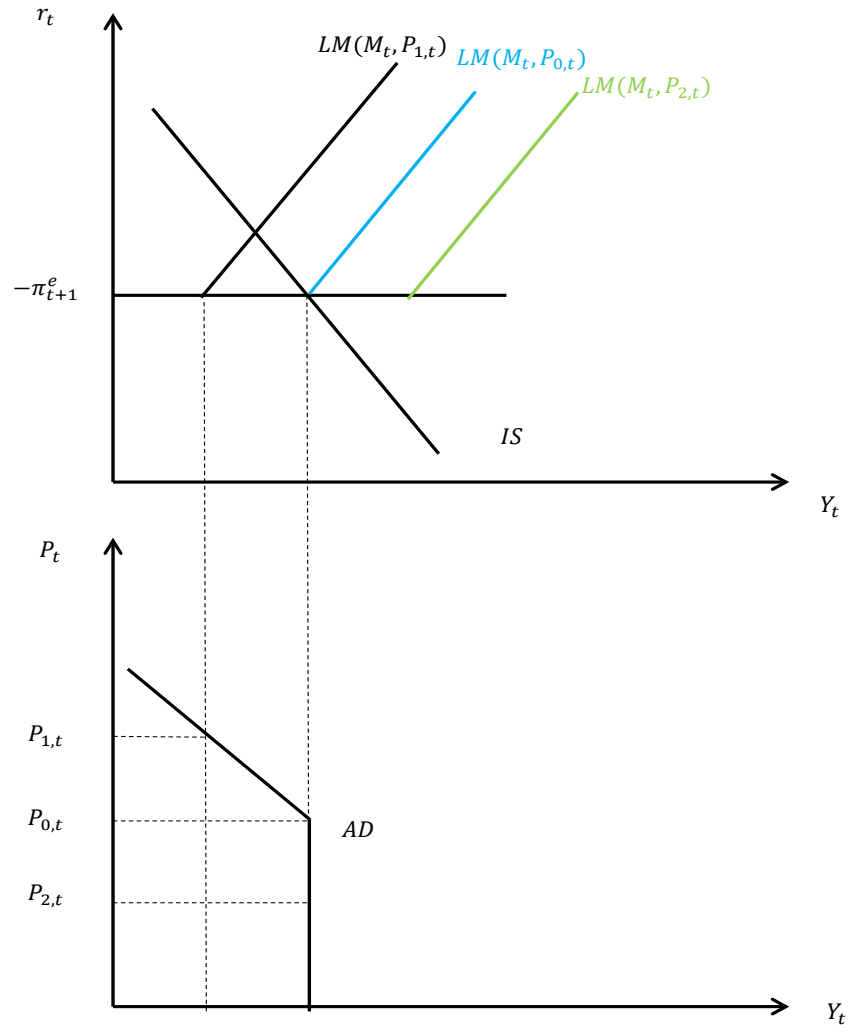

For the rest of this chapter, we will not worry about whether the ZLB is binding or non-binding, and will focus our attention on the case in which it does bind. In this case the LM curve is effectively horizontal and the AD curve becomes vertical. In a sense, we can think about the ZLB as representing the polar opposite of the neoclassical model. In the neoclassical model, the AS curve is vertical and hence output is completely supply determined. In the New Keynesian model with a binding ZLB, output is completely demand determined. Note that we cannot entertain the neoclassical model with a binding ZLB – this would result in either no equilibrium or an indeterminate equilibrium, since both the AS and AD curves would be vertical. There would either be no equilibrium (the AS and AD curves do not lie on top of one another), or an indeterminate price level (the AD and AS curves lie on top of one another, which would determine Y_t but not P_t).

When the ZLB binds, the level of the money supply does not impact the position of the

AD curve. This is shown graphically in Figure 28.5. Since changes in the money supply only impact the position of the upward-sloping portion of the effective LM curve, and not the flat portion, they do not impact the real interest rate and hence do not impact the level of output or the position of the AD curve when the ZLB binds. Note that we do not consider a sufficiently large decline in the money supply, which would shift the upward-sloping portion of the LM curve in so much that the ZLB would cease to bind.

Figure 28.5: Changes in the Money Supply and a Binding ZLB

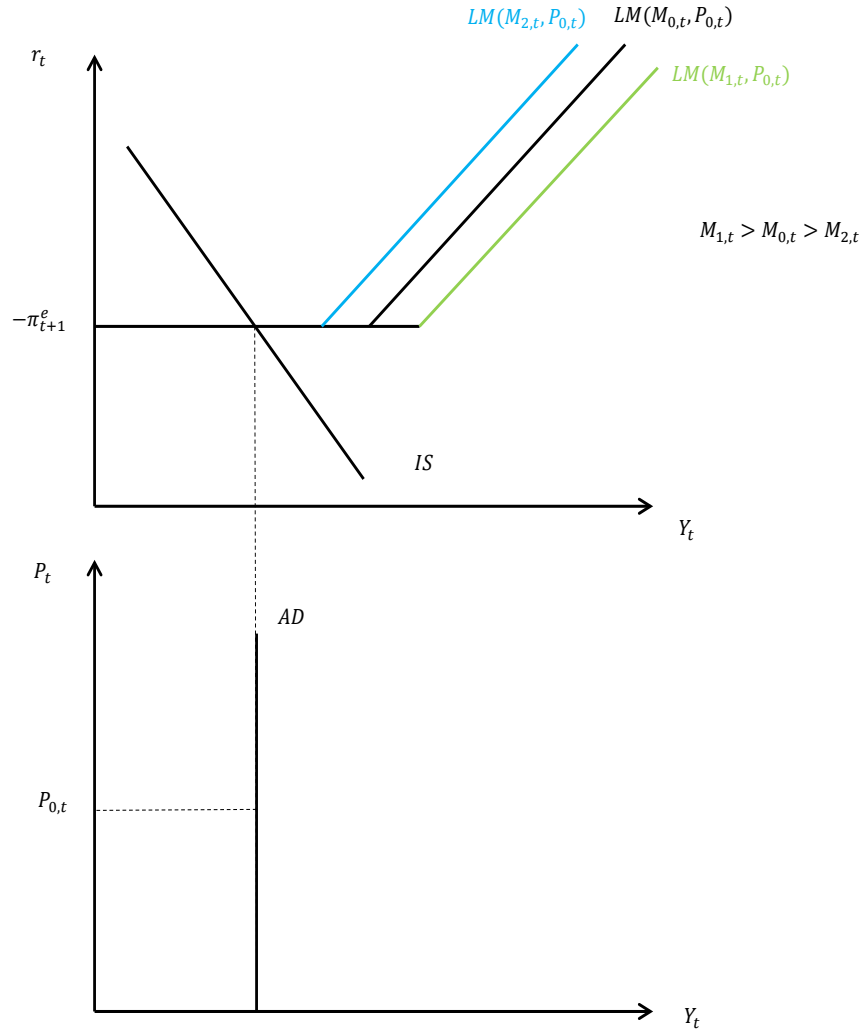

That the money supply does not impact the position of the AD curve when the ZLB binds has important implications. In particular, it means that the central bank ceases to have any control over the real interest rate and output. As we will see, this means that conventional monetary policy is no longer an option at the ZLB.

28.2 Equilibrium Effects of Shocks with a Binding ZLB

In this section, we consider the equilibrium effects of changes in exogenous variables when the ZLB binds. We focus on the partial sticky price model. In the analysis which follows, we assume that the ZLB binds before a shock hits and continues to bind after that shock hits. Put differently, we do not consider the case in which a shock causes the equilibrium to switch to the downward-sloping portion of the AD curve. As such, we will draw pictures where the LM curve is simply a horizontal line – i.e. we do not consider the upward-sloping portion of the LM curve in the ensuing analysis.

Consider first a negative shock to the IS curve. This could be caused by a reduction A_{t+1} or G_t , or an increase in G_{t+1} . We plot out the effects of this negative IS shock in Figure 28.6. We abstract from looking at the behavior of labor market variables. To understand how the and why the ZLB matters, we also draw in hypothetical curves corresponding to a situation in which the ZLB does not bind. The original LM and AD curves when the ZLB binds are shown in black, while the hypothetical original positions of these curves with a non-binding ZLB are shown in orange. After the IS shock, the new curves with the binding ZLB are shown in blue, while they appear in red for the hypothetical case in which the ZLB does not bind.

Figure 28.6: Sticky Price Model: Negative IS Shock with Binding ZLB

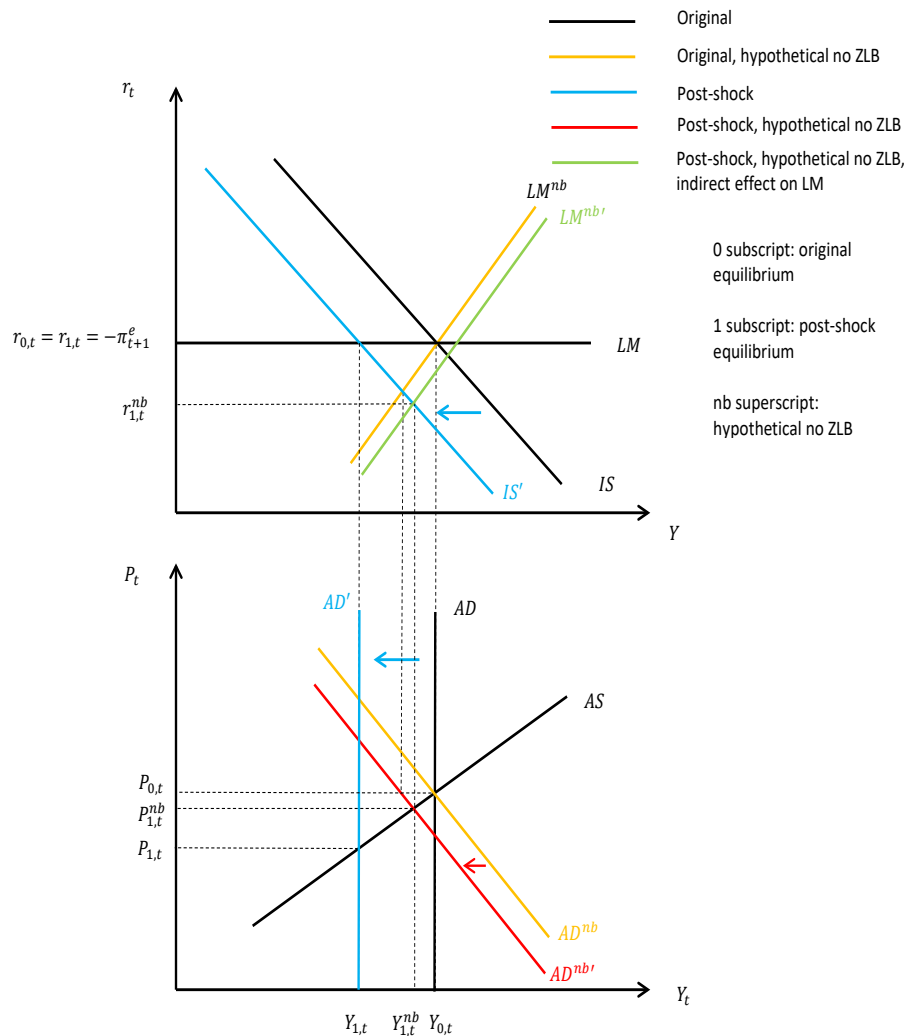

When the ZLB binds, the real interest rate is fixed at $-\pi_{t+1}^e$. The inward-shift of the IS curve causes the vertical AD curve to shift in. The inward shift of the vertical AD curve is the same as the horizontal shift of the IS curve. Output falls from $Y_{0,t}$ to $Y_{1,t}$. Now consider the case where the ZLB does not bind (but the original equilibrium value of output is the same). The inward shift of the IS curve is the same in either case. But because the LM curve is upward-sloping, the level of Y_t where the IS and LM curves intersect does not fall by as much as it does when the LM curve is horizontal. Consequently, the downward-sloping AD curve shifts in, but not as much as the vertical AD curve shifts in when the ZLB binds. In addition, the decline in the price level causes the LM curve to shift out some, further reducing the real interest rate and further mitigating the fall in output. On net, when the ZLB does not bind, output falls, but not by as much as it does when the ZLB binds. The price level declines by more in response to the shock when the ZLB binds in comparison to when it does

not. The reason why output falls by less after the negative IS shock when the ZLB does not bind is because the real interest rate falls. This fall in the real interest rate works to increase desired spending, partially offsetting the decline in desired expenditure resulting from the negative IS shock. When the ZLB binds, the real interest rate cannot fall. This means that output falls by more after the negative IS shock than it would if the ZLB did not bind.

Consider next a positive supply shock. Think of this as resulting from an increase in A_t or a reduction in θ_t . The effects of the supply shock with and without the ZLB binding are shown in Figure 28.7. If the AD curve is vertical, the rightward shift of the AS curve results in no change in output and a large decline in the price level. Intuitively, the reason that output cannot rise is that the real interest rate cannot fall, so there is no incentive for the household or firm to spend more. In contrast, when the ZLB does not bind, the decline in the price level triggers a rightward shift of the LM curve, which allows the real interest rate to fall and output to expand.

Figure 28.7: Sticky Price Model: Positive Supply Shock with Binding ZLB

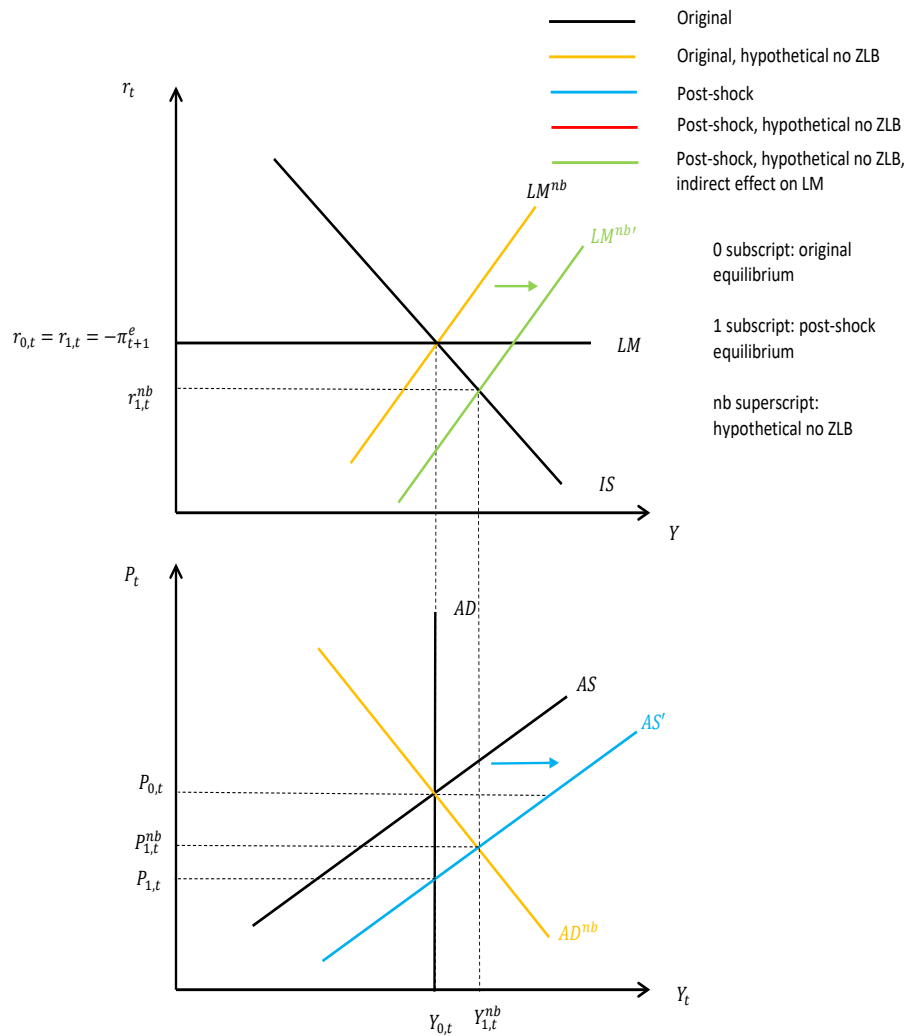

The exercises demonstrated graphically in Figures 28.6 and 28.7 reveal an important point. The ZLB *accentuates* the differences between the New Keynesian and neoclassical models. Output responds even more to IS shocks, and even less to supply shocks (in fact, not at all) compared to the neoclassical model.

28.3 Why is the ZLB Costly?

Central bankers and academics often speak of the ZLB as if it is something of which to be afraid. Why is this? Why is the ZLB considered to be costly?

Firstly, the ZLB is costly because normal monetary policy ceases to work when the nominal interest rate gets stuck at zero. This was touched on in reference to Figure 28.5 above. When changes in the money supply do not affect the real interest rate, conventional

monetary policy will not work. This means that central banks cannot engage in the type of endogenous monetary policy actions discussed in Chapter 27 in response to exogenous shocks. Not being able to conduct policy in this way will therefore accentuate the costs associated with not being at the neoclassical equilibrium. The ZLB is mostly likely to bind after a sequence of negative IS shocks (which shift the IS curve to the left, making it more likely that it intersects the effective LM curve in the flat portion). In response to negative IS shocks, a central bank would like to increase the money supply (and hence lower interest rates) to combat this. But if the interest rate is at the ZLB, it is not possible to lower interest rates further.

The second reason that the ZLB is costly is that the economy's self-correcting mechanism will not restore the short run equilibrium to the medium run neoclassical equilibrium when the ZLB binds. Suppose that an economy finds itself in a situation where the ZLB binds and $Y_{0,t} < Y_t^f$ – i.e. the output gap is negative. This outcome could happen after a sequence of negative IS shocks, which drive output down and cause the ZLB to bind. A situation with a binding ZLB and a negative output gap is depicted in Figure 28.8.

Figure 28.8: Medium Run Supply-Side Dynamics at the ZLB, Sticky Price Model

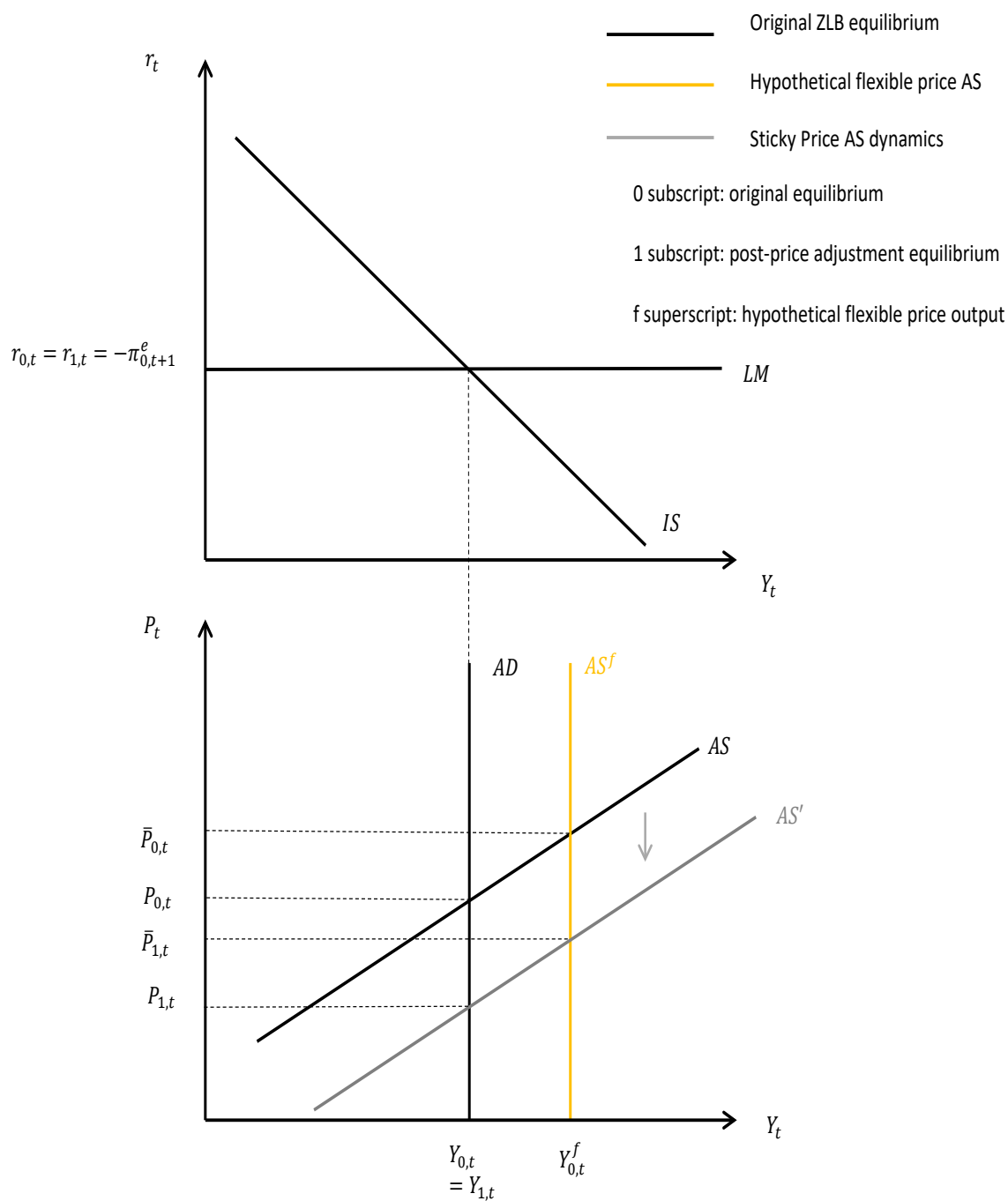

Let us now reference back to our discussion in Chapter 26 about how the AS curve out to adjust starting from a situation with $Y_t < Y_t^f$. In the sticky price model, this means that the equilibrium price level, $P_{0,t}$, is lower than the predetermined component of the price level, $\bar{P}_{0,t}$. Given the chance to adjust, the firm will lower the predetermined component of the price level to something like $\bar{P}_{1,t}$. If the AD curve were its usual downward-sloping shape,

this would cause the output gap to disappear as the economy transitions from short run to medium run. But since the AD curve is vertical when the ZLB binds, the downward shift of the AS curve only results in falling prices and no change in output. In other words, the output gap does not disappear. Furthermore, because $P_{1,t} < \bar{P}_{1,t}$ after the transition of the AS curve, there will be further pressure on the AS curve to shift downward in the future. This will just result in more price level declines but no change in output.

Not only might the economy get stuck with a suboptimally low level of output at the ZLB, things may actually get worse depending on how expectations are formed. As shown in Figure 28.8, the natural dynamics of the price level when the output gap is negative are for prices to fall. In other words, it is natural for a negative output gap to exert deflationary pressures in the economy. If household and firm inflation expectations are exogenous, the economy may get stuck with a suboptimally low level of output, like that shown in Figure 28.8. But what would happen if both the household and the firm start to expect falling prices?

Suppose that the economy finds itself in a situation like that depicted in Figure 28.8. The AS curve has shifted down, but because the AD curve is vertical, this results in no change in output. Now suppose that agents start to expect further future declines in the price level. That is, suppose that expected inflation decreases, from $\pi_{0,t+1}^e$ to $\pi_{2,t+1}^e$, where $\pi_{2,t+1}^e < \pi_{0,t+1}^e$. A decrease in expected inflation effectively raises the lower bound on the real interest rate. This causes the flat portion of the effective LM curve to shift up. The resulting higher real interest rate results in a decline in desired expenditure, and results in the AD curve shifting to the left. This scenario is depicted in Figure 28.9.

Figure 28.9: Medium Run Supply-Side Dynamics at the ZLB, Deflationary Expectations, Sticky Price Model

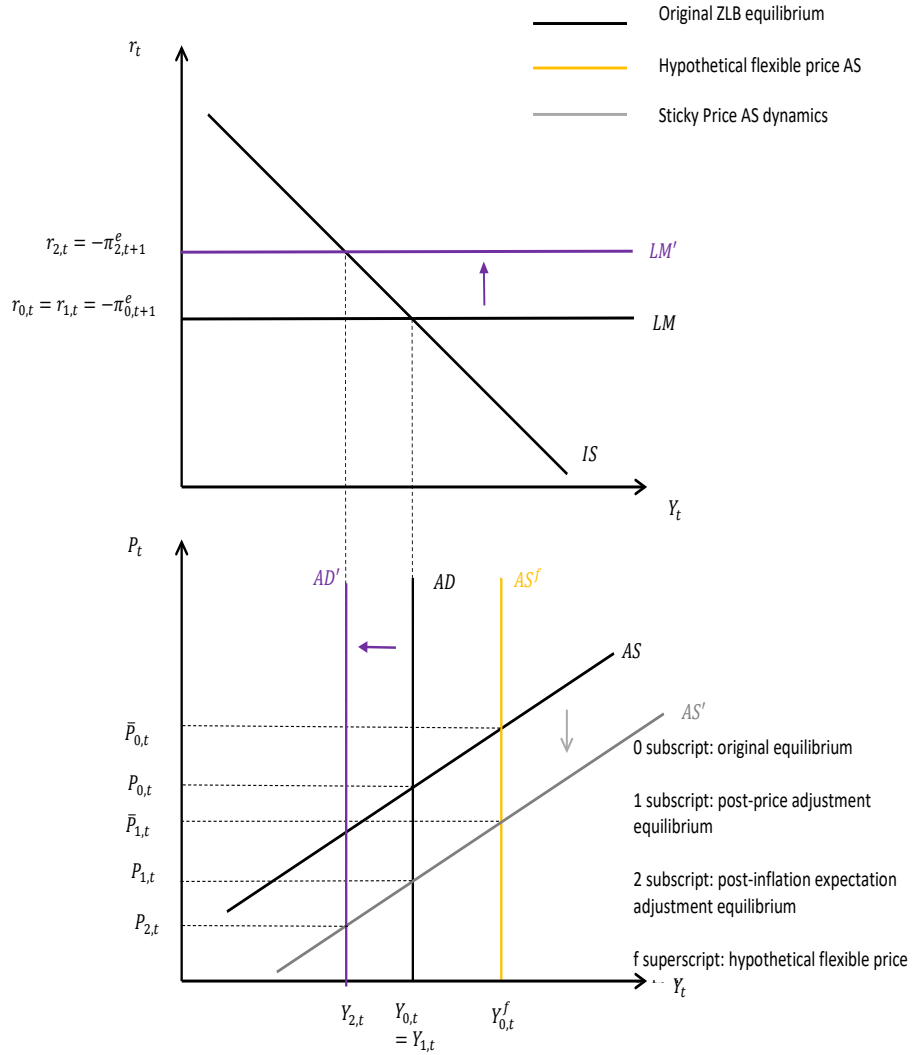

Hence, not only might the economy get stuck with a suboptimally low level of output, as in Figure 28.8, if agents start to expect falling prices, things could actually get worse, as depicted in Figure 28.9. Furthermore, the worsening of conditions depicted above can become self-reinforcing – output will fall further and further below potential, which will put more and more deflationary pressure on the economy. This might fuel further declines in expected inflation, resulting in even higher real interest rates and even lower output. We call such a scenario a “deflationary spiral.” A negative output gap puts downward pressure on prices, but given that the nominal interest rate is fixed at zero, expected deflation pushes the real interest rate up, which only worsens the output gap.

28.4 Fiscal Policy at the ZLB

In Chapter 27, we mentioned how fiscal policy is an undesirable stabilization tool under normal circumstances. The reason for this is that changes in government spending (or taxes, to the extent to which Ricardian Equivalence does not hold) alter the hypothetical neoclassical real interest rate, r_t^f , and therefore impact the split of output between consumption, investment, and government spending. Put somewhat differently, away from the ZLB an increase in government spending may raise output (and hence move output closer to potential), but it results in consumption and investment falling (because of “crowd-out” associated with a higher real interest rate).

Fiscal policy may be substantially more desirable when the ZLB binds. The essential gist of why is that, because the real interest is fixed at the ZLB, there is no crowd out. This is shown graphically in Figure 28.10 when the ZLB binds. An increase in G_t shifts the IS curve out to the right. With a fixed real interest rate, this results in the vertical AD curve shifting out to the right, and no change in the real interest rate.

Figure 28.10: Sticky Price Model: Fiscal Expansion with Binding ZLB

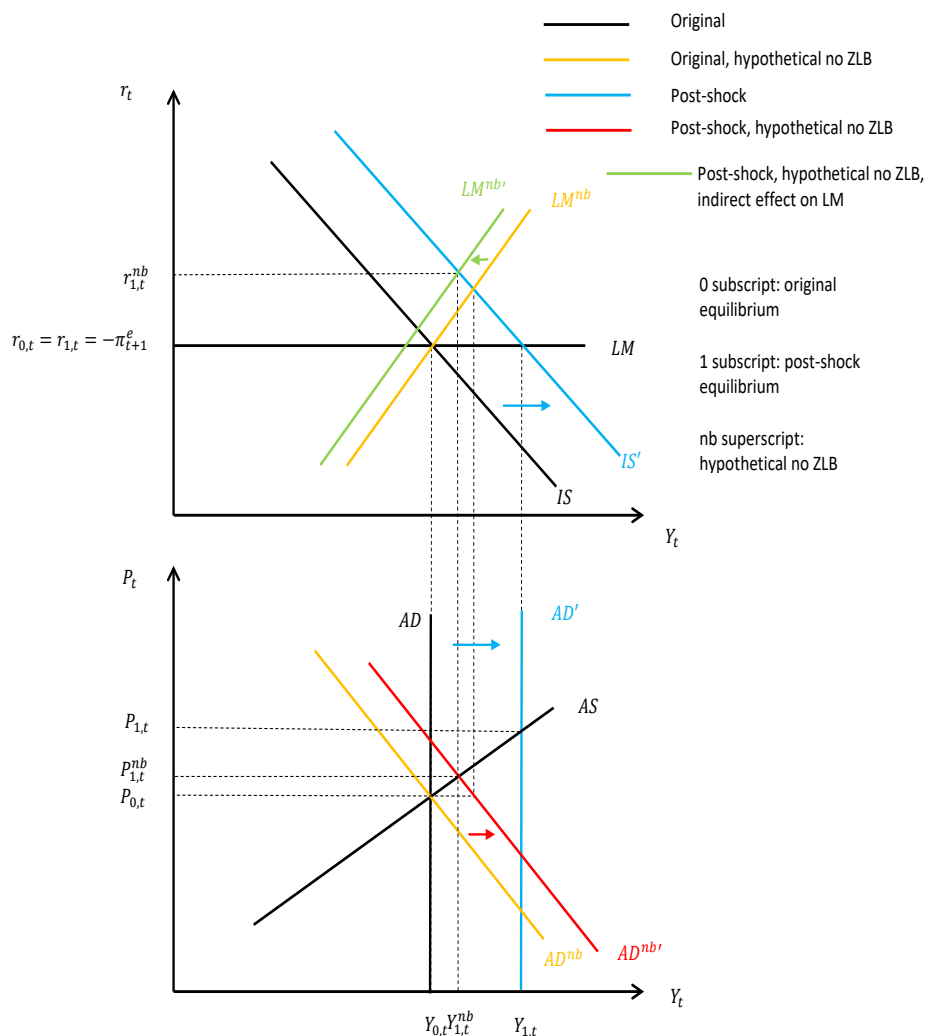

Because there is no change in the real interest rate when the ZLB binds, investment will not fall after the increase in G_t . Assuming Ricardian Equivalence holds, Y_t will increase by the increase in G_t . This, coupled with no change in r_t , means that consumption will not fall either. Output will simply increase one-for-one with government spending. While this may not stimulate consumption and investment, it will stimulate labor input and the real wage. If the ZLB did not bind, in contrast, the rightward shift of the AD would be much smaller, the real interest rate would rise, and the resulting increase in Y_t would be significantly smaller. If Ricardian Equivalence does not hold for some reason, then output could increase by more than government spending, and consumption could rise. In a sense, the reason why fiscal expansion might be more desirable at the ZLB is just a corollary to the fact that IS shocks have bigger effects on output at the ZLB.

28.5 How to Escape the ZLB

The ZLB is costly. Once there, conventional monetary policy is unavailable. Furthermore, the economy will not tend to close an output gap through the usual supply-side adjustments. Furthermore, if expectations are sufficiently forward-looking, anticipation of these supply-side adjustments could trigger changes in expected inflation that only make things worse.

That the ZLB is costly naturally leads to the following question. If an economy finds itself at the ZLB, how can policy be conducted so as to escape it? In a nutshell, there are two options. The first is to use fiscal policy to influence the position of the IS curve. This is similar to the exercise considered in Figure 28.10. If the fiscal expansion is sufficiently large, the IS curve may shift out to the right sufficiently much so that the ZLB no longer binds. This is depicted in Figure 28.11.

Figure 28.11: Fiscal Expansion to Exit the ZLB

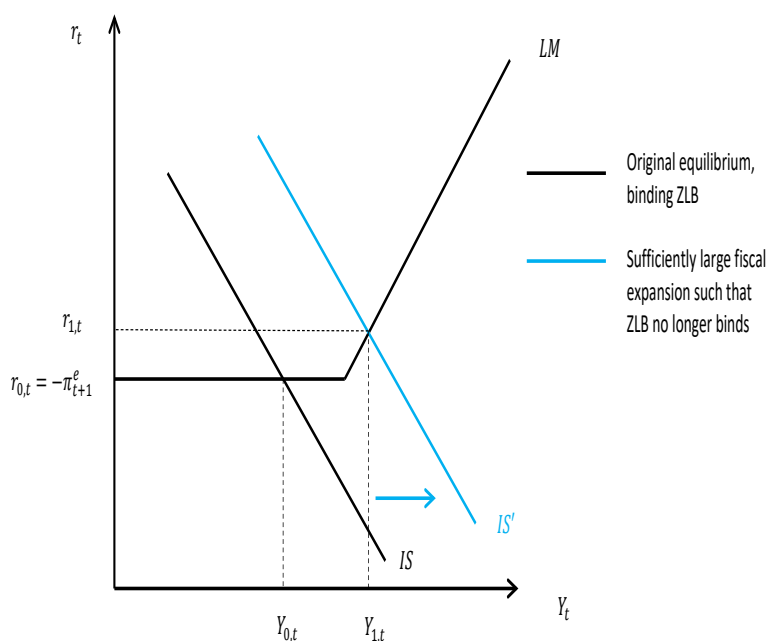

The other option available for escaping the ZLB relies on the manipulation of expected inflation. In particular, the lower bound on the real interest rate is the negative of the rate of expected inflation. If policymakers can engineer an *increase* in expected inflation, this eases the lower bound on the real interest rate, allows the real interest rate to decline and output to expand, and may result in the ZLB no longer binding. Figure 28.12 considers the case where the ZLB is initially binding with expected inflation of $\pi_{0,t+1}^e$. Then it considers an increase in expected inflation to $\pi_{1,t+1}^e > \pi_{0,t+1}^e$. This increase in expected inflation is sufficiently large

so that the IS curve now crosses the effective LM curve in the upward-sloping region – i.e. the ZLB no longer binds. Relative to the original equilibrium, the real interest rate falls and output rises.

Figure 28.12: Engineering Higher Expected Inflation to Exit the ZLB

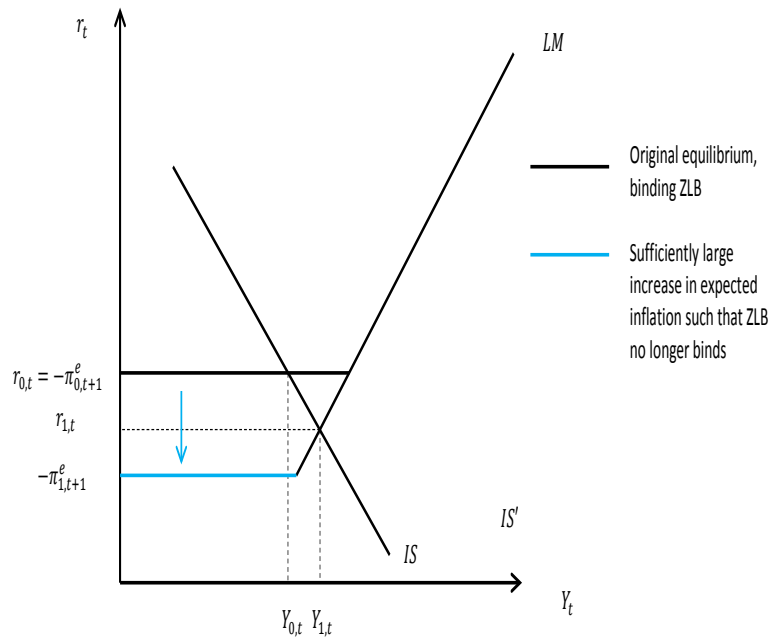

Using policy to engineer higher expected inflation may sound simple in theory, but is likely not easy to do in practice. This is especially true given that the natural dynamics with a binding ZLB are for prices to fall over time, not rise. How might the central bank do this? Effectively, what the central bank would need to do is to communicate to the public that it plans to engage in highly expansionary *future* monetary policy (by future we mean after the ZLB no longer binds). In other words, the central bank needs to commit to creating sufficiently high future inflation. In order to be able to do this, the central bank needs to have a lot of credibility with the public – for this to work, the public must believe that the central bank will do what it says it plans to do. Committing to higher future inflation is one way to think about the recent “Forward Guidance” policy in which the Federal Reserve has been engaging – it has promised to keep interest rates low for a long time, in the hopes that this will stimulate current inflation expectations. We will return more to a discussion of this policy in Chapters 33 and 36.

28.6 How to Avoid the ZLB

The ZLB is costly and may be difficult to escape. As such, central banks would like to design policy so as to minimize the occurrence of hitting the ZLB in the first place. How might policy makers do this?

As we discussed in Chapter 20, over long periods of time the primary determinant of the level of the nominal interest rate is the inflation rate. The inflation rate is in turn determined by the growth rate of the money supply relative to output. A central bank can lower the incidence of hitting the zero lower bound by raising the average level of the nominal interest rate. It can do this by raising its long run inflation target, which can be accomplished by increasing the average growth rate of money relative to output. In light of the analysis pursued in this chapter, the logic is quite simple. The lower bound on the real interest rate is $r_t = -\pi_{t+1}^e$. To the extent to which expected inflation coincides with realized inflation over long periods of time, a higher level of average inflation will correspond to a higher level of expected inflation, which lowers the lower bound on the real interest rate. The smaller lower bound on the real interest rate naturally means that it is less likely that the IS curve will shift sufficiently far to the left to intersect the effective LM curve in the flat region. In short, the higher is the average inflation rate, the less likely it is to hit the zero lower bound.

Another way to think about the effects of the inflation rate on the incidence of hitting the ZLB is to appeal to the discussion of the natural rate of interest from Chapter 27. An optimizing central bank would like to implement $r_t = r_t^f$, where r_t^f is the real interest rate which would emerge in the absence of price rigidity. From the Fisher relationship, $r_t = i_t - \pi_{t+1}^e$. Equating these two, we can think about optimal monetary policy as adjusting the money supply so as to set $i_t = r_t^f + \pi_{t+1}^e$. To the extent to which expected inflation is stable, the central bank wants to adjust the nominal interest rate to move along with the natural rate of interest. The higher is π_{t+1}^e , the more “wobble room” the central bank has to lower i_t when r_t^f falls sufficiently. Hence, by raising its inflation target (and hence expected inflation), the central bank can make it less likely that it would want to lower i_t to less than zero.

Based on the logic expounded upon in the paragraphs above, why wouldn't central banks want to raise inflation targets to a point where the economy would never bump into the ZLB? The reason, as discussed in Chapter 21, is that high inflation rates (and hence high nominal interest rates) are costly. This can be seen from (28.1) above. In the medium run, real quantities are independent of nominal variables. Hence, the marginal utility of consumption, $u_C(C_t, 1 - N_t)$, is not influenced by nominal variables. The larger is i_t , the larger is $\frac{i_t}{1+i_t}$. This means that $v'(\frac{M_t}{P_t})$ must be larger for (28.1) to hold, which means that $\frac{M_t}{P_t}$ must be smaller. Hence, the larger is the nominal interest rate, the smaller will be real money balances

in the medium run. Since the household receives utility from holding real balances, lower real balances translate into lower utility. As we discussed in Chapter 15, the Friedman rule characterizes optimal monetary policy in the neoclassical model, and entails setting $i_t = 0$, which maximizes utility from real money balances.

Hence, when thinking about avoiding the ZLB in the short run, a central bank must balance its desire to have low inflation and low nominal interest rates in the medium run (i.e. its desire to be at or near the Friedman rule), with its desire to have the nominal interest rate sufficiently far from zero to avoid hitting the ZLB in the short run. There are other potential costs associated with higher nominal interest rates (and hence higher inflation rates) which are not captured in our model. These include so-called “shoeleather costs” referencing the fact that, in a high inflation environment, people will try to avoid holding money to the extent possible, which entails trips to and from the bank to get cash (hence wearing out the leather on one’s shoes). In addition, in a more sophisticated model with firm heterogeneity, higher rates of average inflation can introduce non-optimal distortions into the relative price of goods when some firms can adjust their prices and others cannot. [Coibion, Gorodnichenko, and Wieland \(2012\)](#) study the optimal inflation rate in a sticky price New Keynesian model similar to the one developed in this book. Their analysis balances the costs of higher inflation (and hence higher nominal interest rates) with the benefit of a reduced incidence of hitting the ZLB. They find that the optimal inflation rate is about 2 percent per year, which is close to what it has been in the US since the early 1980s.

28.7 Summary

- Since the nominal interest rate is the return on investing money, it cannot go much below 0. The reason is that instead of investing money in a bank for a negative return, one could put money in their mattress and receive no return. In actuality, there are transaction costs to holding large amounts of money which opens the door to slightly negative nominal interest rates. Near zero nominal interest rates is described as the zero lower bound (ZLB).
- In the region where the ZLB is binding the LM curve is flat and the AD curve is vertical. An implication of this is that output is completely demand determined which is completely opposite of the Neoclassical model in which output is supply determined.
- At the ZLB, changes in the money supply do not affect the AD curve. However, the effects of any other demand shock exacerbates the output response at the ZLB relative to normal times whereas the effects of supply shocks are smaller.

- The ZLB is bad from a policy perspective because it prevents monetary policy makers from lowering nominal interest rates and because it prevents the dynamics transitioning from the short to medium run.
- Increases in government spending are particularly effective at the ZLB because such spending does not raise the real interest rate so there is no crowding out.
- Policy makers can attempt to exit the ZLB by increasing government spending or by increasing inflation expectations.
- Economies can avoid hitting the ZLB in the first place by maintaining a sufficiently high inflation rate. The higher the inflation rate the farther the economy is away from the Friedman rule. Hence, there is a tension of wanting the interest rate high enough in the short run to avoid the ZLB and low enough in the medium term to come close to the Friedman rule.

Questions for Review

1. Explain what is meant by a “deflationary spiral” and why the normal mechanism which restores the efficient neoclassical equilibrium may not work at the ZLB.
2. Explain the tradeoffs at play when considering raising the long run inflation target as a means by which to avoid hitting the ZLB.
3. Intuitively, explain why changes in government spending have a bigger effect on output at the ZLB than away from it.
4. In the text, we have thought about the kind of shock which might make the ZLB bind as a negative shock to the IS curve (e.g. a reduction in f_t). Could a shock to A_t make the ZLB bind? What sign would this shock have to be to make it bind? In the data, most episodes where the ZLB binds (the US in the wake of the Great Recession, Japan during the 1990s, and the US during the Great Depression) output is low. Given this, would a supply shock as the reason for a binding ZLB make empirical sense?

Exercises

1. Suppose that you have a sticky price New Keynesian model in which the ZLB is binding. Consider an exogenous reduction in f_t . Show how this affects the equilibrium values of the endogenous variables of the model, including

labor market variables. Comment on how these effects compare relative to the case in which the ZLB does not bind.

Chapter 29

Open Economy Version of the New Keynesian Model

In this chapter we consider an open economy version of the New Keynesian model with which we have been working. For this chapter, we will focus on the partial sticky price New Keynesian model, which generalizes the simple sticky price model and the neoclassical model.

As in the open economy version of the neoclassical model explored in Chapter 22, the openness of the economy affects only the demand side. In particular, there is a new term in desired expenditure, net exports. Net exports depend on the real exchange rate and a variable which we take to be exogenous to the model, Q_t . The real exchange rate in turn depends on the real interest rate differential between the home and foreign economy.

The equations characterizing the equilibrium of the open economy version of the sticky price model are similar to Chapter 22, with the exception that we replace the labor demand curve with the partial sticky price AS curve.

$$C_t = C^d(Y_t - G_t, Y_{t+1} - G_{t+1}, r_t) \quad (29.1)$$

$$I_t = I^d(r_t, A_{t+1}, K_t) \quad (29.2)$$

$$NX_t = NX^d(r_t - r_t^F, Q_t) \quad (29.3)$$

$$Y_t = C_t + I_t + G_t + NX_t \quad (29.4)$$

$$N_t = N^s(w_t, \theta_t) \quad (29.5)$$

$$P_t = \bar{P}_t + \gamma(Y_t - Y_t^f) \quad (29.6)$$

$$Y_t = A_t F(K_t, N_t) \quad (29.7)$$

$$M_t = P_t M^d(r_t + \pi_{t+1}^e, Y_t) \quad (29.8)$$

$$r_t = i_t - \pi_{t+1}^e \quad (29.9)$$

$$\epsilon_t = h(r_t - r_t^F) \quad (29.10)$$

$$e_t = \epsilon_t \frac{P_t}{P_t^F} \quad (29.11)$$

(29.1) is the standard consumption function, and (29.2) is the conventional investment demand function. (29.3) is the net export demand function. Net exports depend negatively on the real interest rate differential, $r_t - r_t^F$, where r_t^F is the exogenous foreign real interest rate. (29.4) is the open economy resource constraint. (29.5) is the labor supply curve, where labor is increasing in the real wage and decreasing in the exogenous variable θ_t . The sticky price AS curve is reflected in (29.6). The aggregate production function is (29.7). Money demand is given by (29.8), with the money supply exogenously set by a central bank. The Fisher relationship is (29.9). The real exchange rate, ϵ_t , is a function of the real interest rate differential. This is given in (29.10). The real exchange rate is a decreasing function of the real interest rate gap. If the domestic real interest rate is higher than the foreign real interest rate, then there will be excess demand for domestic goods, which will cause the domestic currency to appreciate (which means ϵ_t declines). The relationship between the real and nominal exchange rates is given by (29.11), where e_t is the nominal exchange rate. These are exactly the same expressions as in the open economy version of the neoclassical model, except that we replace the labor demand curve with an exogenously fixed price level. Note that the supply side of the model is unaffected by the openness of the economy; hence Y_t^f in the open economy is the same as it would be in a closed economy.

In the sections below, we will provide a graphical depiction of these equilibrium conditions. We will then use the graphical setup to analyze the effects of changes in exogenous variables on endogenous variables. We will discuss how monetary policy interacts with the exchange rate regime (floating or fixed) and what this means for domestic policy. On the basis of this, we will include a discussion about the costs and benefits of monetary unions (such as the Euro), which can be thought of as many countries grouping together with a fixed exchange rate.

29.1 Deriving the AD Curve in the Open Economy

The sticky price assumption affects only the supply side of the economy, which is identical in both the open and closed variants of the model. As with the closed economy variant of the model, we will again use the IS-LM-AD curves to summarize the demand side of the economy.

As we discussed in Chapter 22, the open economy IS curve is flatter than the closed economy IS curve. Intuitively, this is simply because aggregate expenditure is more sensitive to the real interest rate when there is an additional expenditure component which depends negatively on the real interest rate (net exports). How does the flatter IS curve impact the shape of the AD curve?

We can graphically derive the AD curve in the usual way. For point of comparison, in Figure 29.1, we derive the AD curve both for a closed economy (red, relatively steep IS curve) and an open economy (black, comparatively flatter IS curve). An increase in the price level causes the LM curve to shift in. Along a downward-sloping IS curve, an inward shift of the LM curve results in a higher real interest rate and consequently a lower level of Y_t . For a given inward (or outward) shift of the LM curve, the decline in Y_t is larger the flatter is the IS curve. Tracing out the (P_t, Y_t) combinations where the economy sits on both the IS and LM curves, one can see that the AD curve will be flatter in the open economy compared to the closed economy.

Figure 29.1: The AD Curve: Open vs. Closed Economy

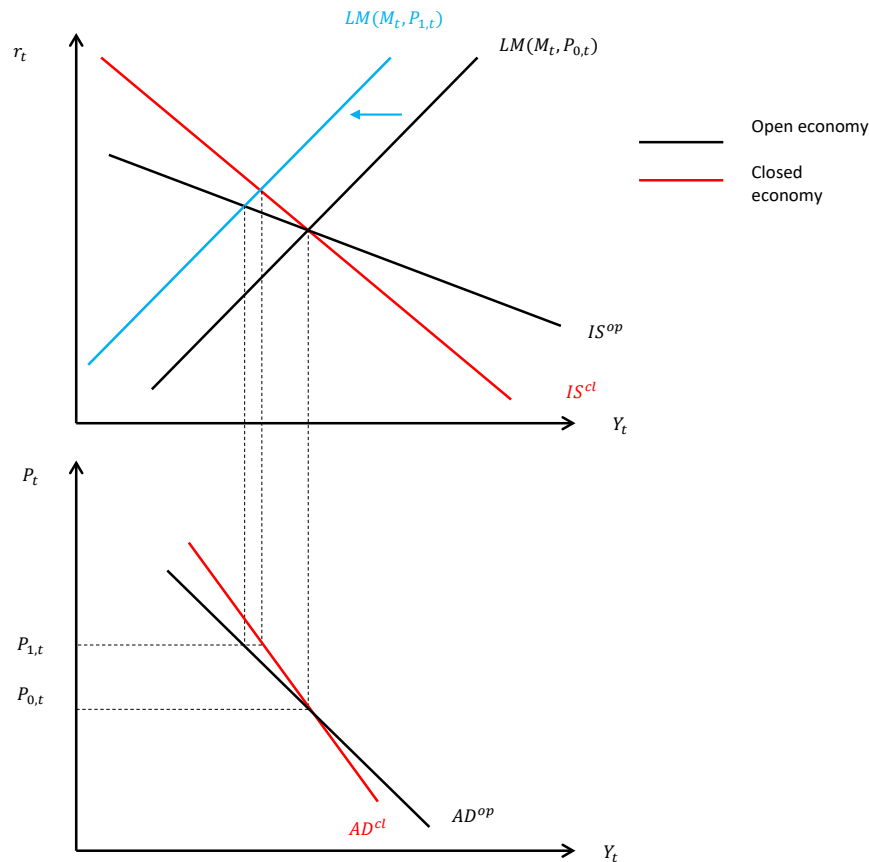

The AD curve will shift in response to changes in exogenous variables which affect the positions of the IS or LM curves. This includes the usual set of variables from the closed economy version of the model – A_{t+1} , G_t , and G_{t+1} affect the IS curve, and M_t affects the LM curve. In the open economy version of the model, r_t^F and Q_t will also affect the position of the AD curve through an effect on desired expenditure through net exports. An increase in

r_t^F lowers $r_t - r_t^F$ for a given r_t ; this results in a currency depreciation and an increase in net exports, which causes the IS curve to shift to the right. Hence, an increase in r_t^F will cause the AD curve to shift out to the right. An increase in Q_t represents an exogenous increase in desired net exports. This will also result in outward shift of the IS curve and therefore a rightward shift of the AD curve.

29.2 Equilibrium in the Open Economy Model

The supply side of the open economy version of the sticky price New Keynesian model is identical to the supply side in the closed economy model. The AS curve is given by $P_t = \bar{P}_t + \gamma(Y_t - Y_t^f)$. \bar{P}_t is an exogenous variable and represents the predetermined component of the price level. The intersection of the AD and AS curves determines Y_t . Given Y_t , N_t is determined from the production function to be consistent with this level of output. The real wage is then determined from the labor supply curve at this level of labor input. Y_t^f is the level of output which would be consistent with being on both labor demand and supply curves.

Figure 29.2 graphically characterizes the equilibrium of the sticky price open economy model. Qualitatively, this picture looks *exactly* the same as in the closed economy model. The effects of changes in exogenous variables will therefore be *qualitatively* similar to the closed economy version of the model, but some care needs to be taken, because the IS curve (and hence the AD curve) are flatter in the open economy version of the model. The labor demand curve is drawn in orange because this allows us to determine Y_t^f . We assume that the economy initially begins with $Y_t = Y_t^f$, which means that $P_t = P_t^f$.

Figure 29.2: Equilibrium in the Open Economy Sticky Price Model

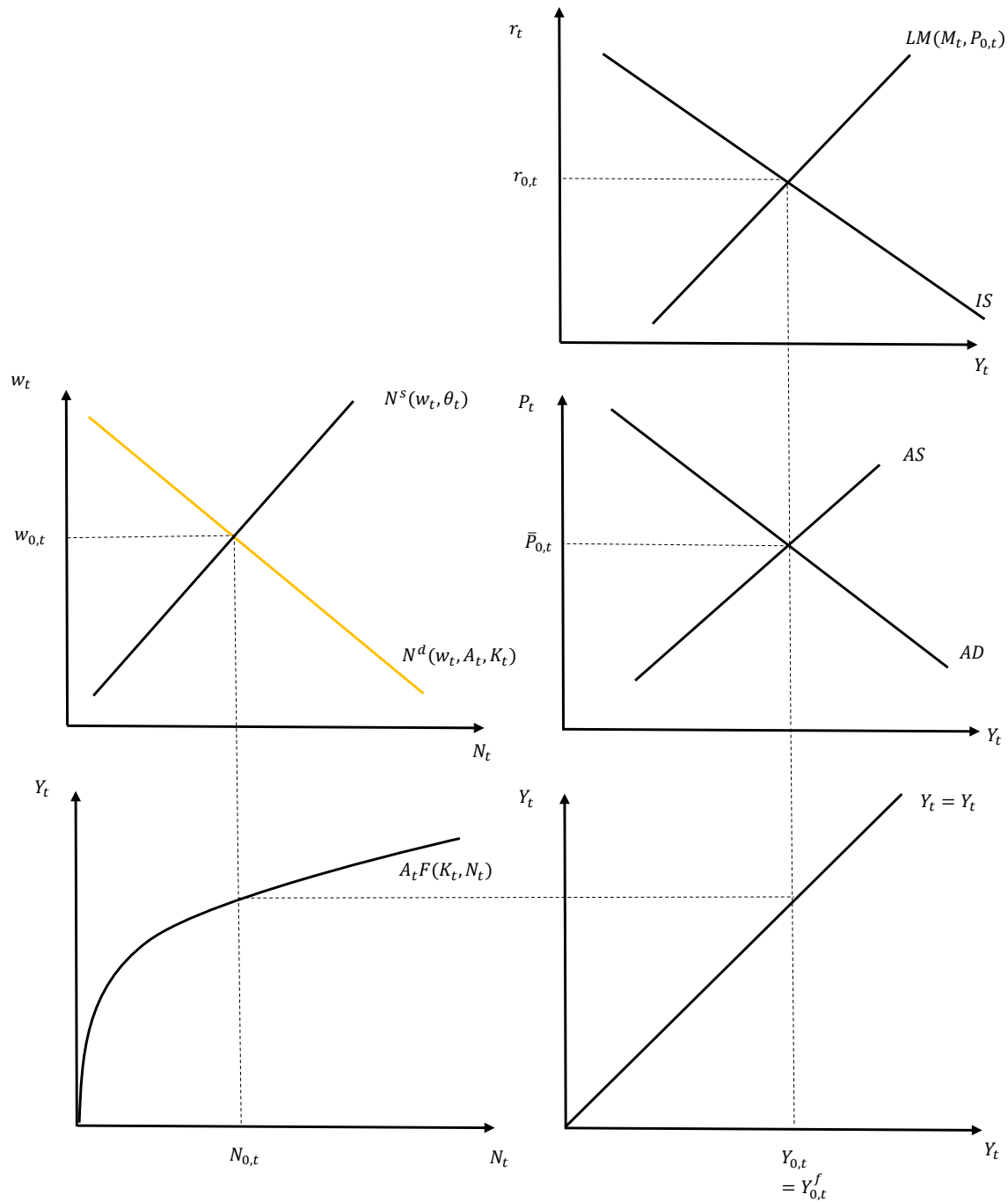

29.3 Comparing the Open and Closed Economy Variants of the Model

In this section, we want to examine how the endogenous variables of the model change in response to shocks in the open economy model in comparison to the closed economy variant

of the sticky price model. Because these graphs will get messy, it is easiest if we work in the simple sticky price model version of the model (in which $\gamma = 0$). Having the price level effectively fixed simplifies matters because we need not worry about “indirect” effects on the position of the LM curve owing to changes in the price level. All of the results which follow are qualitatively similar in the more general partial sticky price model.

Let us first consider a positive shock to the LM curve, concretely an increase in the money supply (a change in expected inflation would have qualitatively similar effects). These effects are documented in Figure 29.3. The black lines correspond to the curves in the initial equilibrium of the open economy sticky price model. The orange lines are hypothetical curves (prior to the change in the money supply) in a closed economy variant of the model. As discussed above, the IS curve (and hence the AD curve) are steeper in the closed economy version of the model. The blue lines show the effect of the increase in the money supply in the open economy model. The red line depicts how the hypothetical AD curve in the closed economy would shift. 0 subscripts denote the initial, pre-shock equilibrium, which we assume is the same in both the open and closed economy variants of the model. 1 subscripts denote post-shock equilibrium values. A superscript “op” denotes open, while a superscript “cl” stands for closed.

Figure 29.3: Increase in M_t : Open vs. Closed Economy

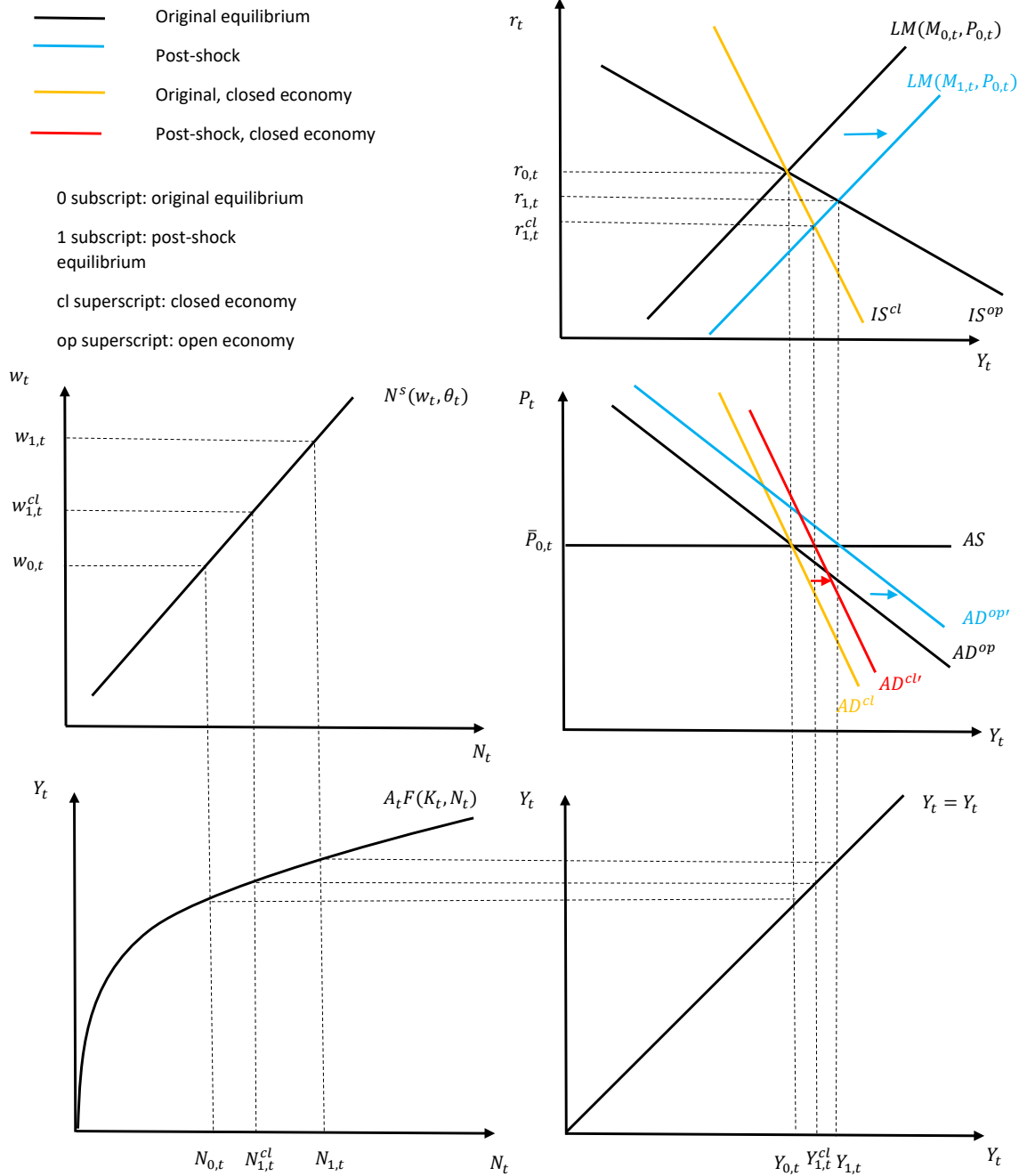

The outward shift of the LM curve (which is the same in both variants of the model) results in higher output and a lower real interest rate. This causes the AD curve to shift out to the right in either the open or closed economy versions of the model. Because the IS curve in the open economy model is flatter than in the closed economy model, output increases by more (and the real interest rate falls by less) when the economy is open than when it

is closed. Consequently, the AD curve shifts out further to the right in the open economy model than it does in the closed economy model. As a result, the labor input increases by more after an increase in the money supply when the economy is open than when it is closed. Since the real wage is determined off of the labor supply curve, the real wage also increases by more after an increase in the money supply in the open economy version of the model in comparison to the closed economy variant.

We conclude that monetary policy is relatively more potent in impacting the real economy in the open economy sticky price model. Note that this is in spite of the fact that the increase in M_t generates a smaller decrease in the real interest rate in the open economy model. What accounts for this? Whereas in the closed economy model, the only mechanism by which monetary policy impacts real output is through an effect on the real interest rate. In the open economy model, changes in the money supply impact both the real interest rate and the real exchange rate (which is indirectly impacted by the real interest rate). In particular, a monetary expansion lowers the real interest rate. This makes the US a relatively unattractive place to save, which reduces the demand for its currency. Consequently, the US currency depreciates. This depreciation stimulates net exports. So the “monetary transmission” mechanism in the open economy model includes both an affect on real interest rates as well as an effect on the exchange rate, and hence net exports. Because of this, monetary policy is relatively more potent in the open economy compared to the closed economy.

Next, consider the effects of a positive shock to the IS curve. This could arise because of an increase in A_{t+1} , an increase in G_t , or a reduction in G_{t+1} . For this exercise, we will consider only changes in closed economy exogenous variables – we will focus on the effects of changes in open economy exogenous variables in the next section. The effects of a positive IS shock in both an open and a closed economy version of the sticky price model are depicted in Figure 29.4. The labeling of the figure is the same as Figure 29.3.

Figure 29.4: Positive IS Shock: Open vs. Closed Economy

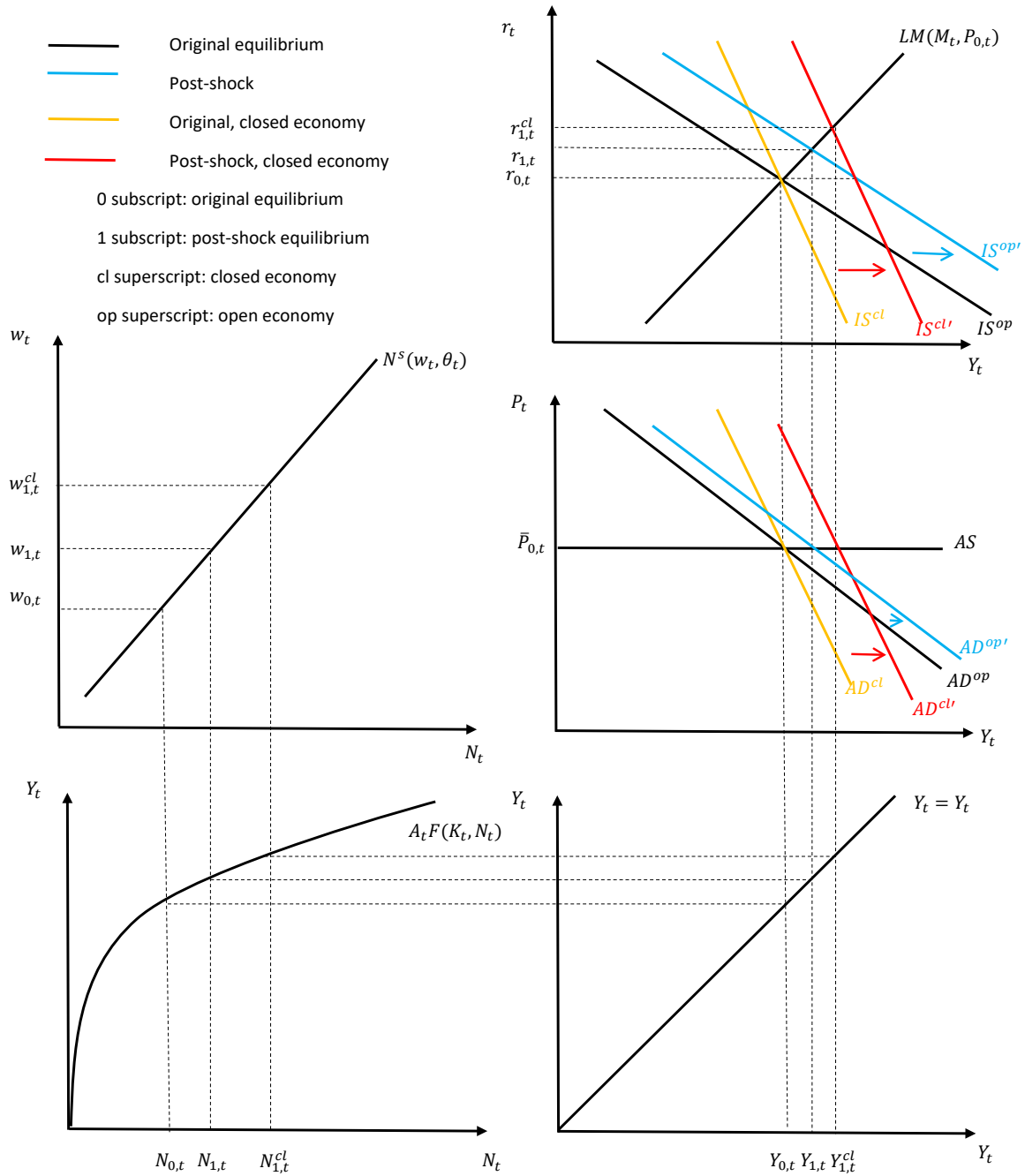

In either the open or closed economy versions of the model, the horizontal shift of the IS curve is the same – i.e. this says what would happen to desired expenditure holding the real interest rate fixed, and with a fixed real interest rate, net exports would be constant in response to a change in a domestic exogenous variable, so the horizontal shift of the IS curve is the same in both variants of the model. However, we can see that the increase in Y_t and

the increase in r_t are both smaller in the open economy version of the model in comparison to the closed economy variant. This means that the AD curve shifts out *less* in response to an IS shock when the economy is open in comparison to when the economy is closed. Consequently, the change in labor input and the increase in the real wage are smaller when the economy is open than when it is closed. The reason for why an IS shock has a smaller effect in the open economy model in comparison to the closed economy model are, in a sense, the mirror image of why shocks to the LM curve have bigger effects in the open economy model. Because the IS shock raises the real interest rate, it results in an appreciation of the home currency, which drives down net exports.

In conclusion, when the economy is open, demand shocks resulting from LM shifts have *larger* effects on output while demand shocks resulting from IS shifts (due to changes in domestic exogenous variables) have *smaller* effects on output in comparison to the closed economy model. Because the AS curve is horizontal in the sticky price model, changes in A_t or θ_t do not affect output in either variant of the model. Although we will not do the exercise here, changes in the exogenous price level, \bar{P}_t , will have bigger effects on output in the open economy model in comparison to the closed economy model (because the AD curve is flatter in the open economy model).

Table 29.1 shows the qualitative signs of the effects of an increase in the money supply or a positive IS shock on various endogenous variables of the model. It also includes a comment referring to whether the change is bigger or smaller in an open or closed economy, where “OP” stands for open and “CL” denotes closed. We also show how the real and nominal exchange rates are affected. From (29.10), the real exchange rate is a decreasing function of $r_t - r_t^F$. Hence, the real exchange rate moves in the opposite direction of r_t . Note that an increase in ϵ_t is a depreciation of the home currency, while an increase in ϵ_t is an appreciation. A depreciation results in higher net exports, while an appreciation results in lower net exports. From (29.11), with P_t fixed because of the sticky price assumption, the real and nominal exchange rates move together one-for-one.

Table 29.1: Comparing the Open and Closed Economy Variants of the Sticky Price Model

Variable	Exogenous Shock	
	$\uparrow M_t$	\uparrow IS curve
Change in Y_t	+ OP > CL	+ OP < CL
Change in N_t	+ OP > CL	+ OP < CL
Change in w_t	+ OP > CL	+ OP < CL
Change in r_t	- OP < CL	+ OP < CL
Change in ϵ_t	+	-
Change in e_t	+	-
Change in NX_t	+	-

29.3.1 Comparison in the Small Open Economy Version of the Model

In Chapter 22, we said that an extreme version of the open economy model is the so-called small open economy model. In the small open economy model, $h'(r_t - r_t^F) = -\infty$. Effectively, any deviation of the domestic real interest rate from the foreign real interest rate would trigger a very large change in the real exchange rate. This makes net exports extremely sensitive to the real interest rate, and has the effect of making the open economy IS curve perfectly horizontal at the exogenous foreign real interest rate, r_t^F . The equilibrium of the small open economy sticky price model is depicted in Figure 29.5. For generality we consider the partial sticky price model, so we draw in an orange labor demand curve, which allows us to determine the neoclassical level of output. We assume that the equilibrium of the economy initially coincides with the hypothetical flexible price neoclassical model.

Figure 29.5: Equilibrium in the Small Open Economy Sticky Price Model

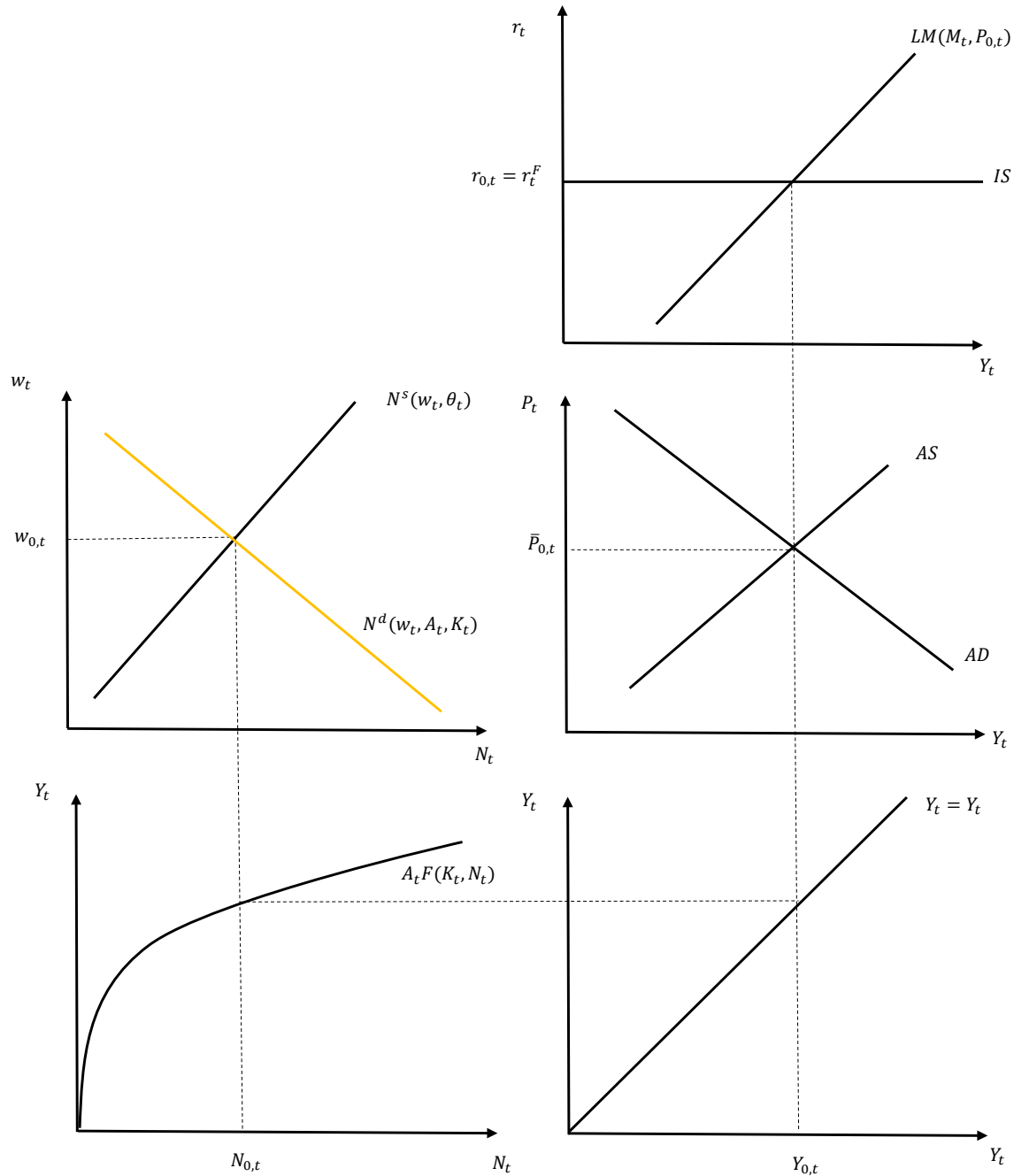

We have previously argued that the IS curve in the open economy is flatter than the IS curve in the closed economy. The small open economy is just an extreme version of this – in the small open economy, the IS curve is even flatter (in fact, perfectly horizontal). This has the implication that the AD curve will be even flatter in the small open economy in comparison to the open economy (though the AD curve will still be downward-sloping).

Figure 29.6 depicts the effects of a monetary expansion in the small open economy version of the model in comparison to a closed economy. We again revert to the simple sticky price model assumption in which the AS curve is horizontal.

Figure 29.6: Increase in M_t : Small Open vs. Closed Economy

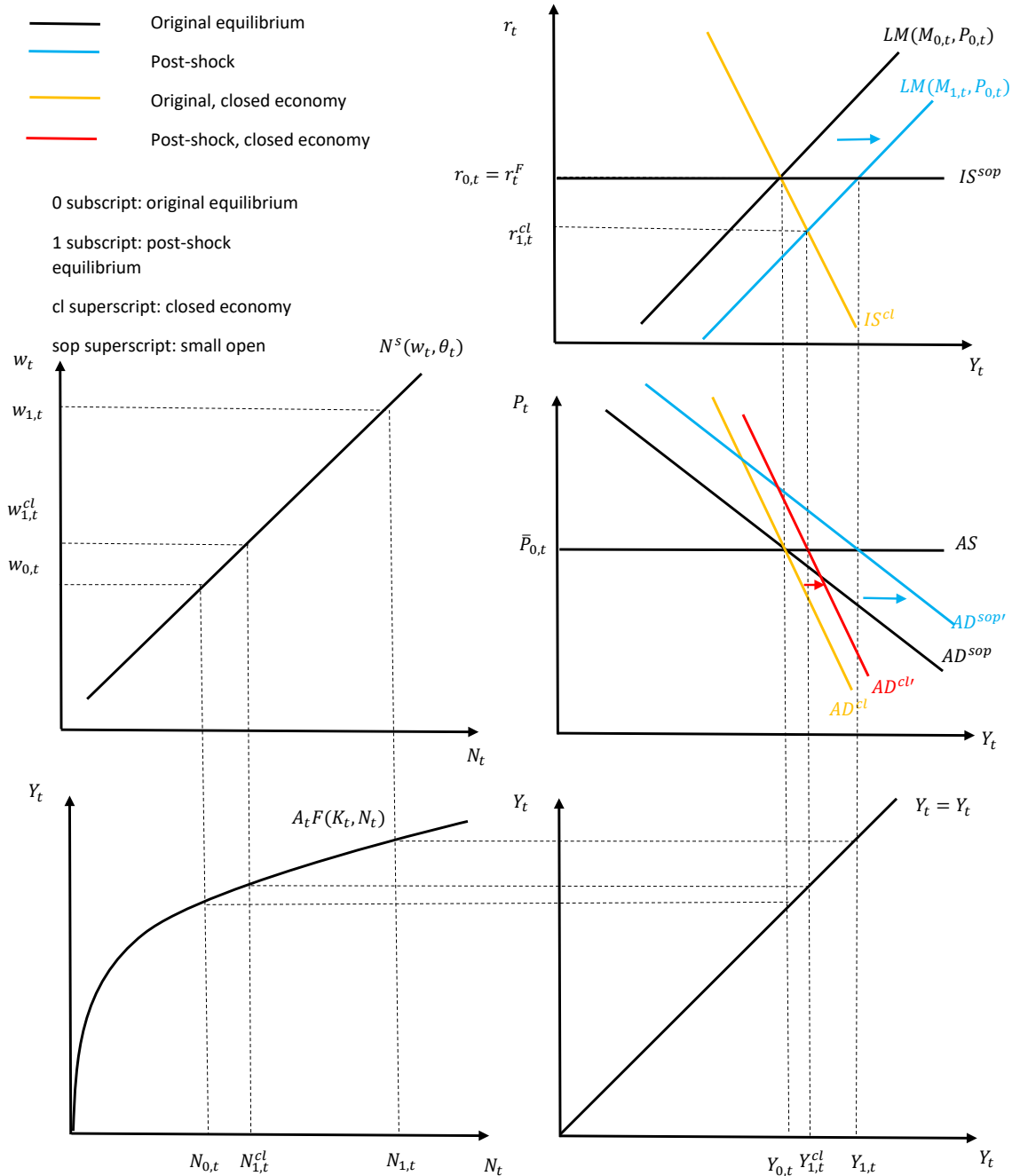

In the small open economy version of the model, output (and hence labor input and the real wage) increase by even more in comparison to the closed economy model than in the

open economy model where the IS curve is downward-sloping. Interestingly, this happens even though the real interest rate does not change. What is going on? We can think about the monetary expansion as putting an incredibly small amount of downward pressure on r_t (even though in the figure r_t is unaffected, for thinking about the intuition suppose it decreases by a very small amount). This small downward pressure on r_t puts upward pressure on the exchange rate, which stimulates net exports. Hence, in the small open economy, the monetary transmission mechanism is not related to the real interest rate, but rather to the real exchange rate. The real exchange rate depreciates when the money supply increases, which triggers an increase in net exports.

Next, consider a shock to a domestic exogenous variable which would ordinarily cause the IS curve to shift horizontally to the right. Because the IS curve is horizontal in the small open economy model, there ends up being no horizontal shift in the IS curve, and therefore no effect on output, the real wage, or labor input. In other words, graphically there is no effect on the equilibrium.

But there must be some effect on the components of expenditure. Why is this? In equilibrium, we must have $Y_t = C_t + I_t + G_t + NX_t$. Suppose that the exogenous variable which would ordinarily cause the IS curve to shift to the right is an increase in G_t . If G_t increases but Y_t is unchanged, some of the components of aggregate expenditure must be affected. But since r_t is unaffected, I_t will also be unaffected. Since $Y_t - G_t$ goes down, C_t must also fall (though not one-for-one). Hence, NX_t must also fall. What is the mechanism giving rise to this? As in the case of the increase in M_t , think about the increase in G_t exerting a small amount of upward pressure on r_t . This would trigger a very large decrease in ϵ_t (i.e. an appreciation of the currency), which would in turn trigger a decline in NX_t . In other words, an IS shock triggers an appreciation of the domestic currency, which effectively completely “crowds out” net exports, leaving total output unchanged.

We can thus conclude that, in the small open economy version of the model, the relative magnitudes highlighted in Table 29.1 are exacerbated – a change in M_t has an even bigger effect on output, whereas a positive IS shock has no effect on output. A comparison of the magnitude of the effects is summarized in Table 29.2 below. A monetary shock has bigger effects in the small open economy compared to the open economy (and in turn in comparison to the closed economy), while the reverse is true for a shock to the IS curve. The real exchange rate and net exports move in the same direction in the small open and open economy versions of the model in response to shocks, but the effects are bigger in the small open economy model.

Table 29.2: Comparing the Small Open and Open Economy Variants of the Sticky Price Model

Variable	Exogenous Shock	
	$\uparrow M_t$	\uparrow IS curve
Change in Y_t	+ SOP > OP	0 SOP < OP
Change in N_t	+ SOP > OP	0 SOP < OP
Change in w_t	+ SOP > OP	0 SOP < OP
Change in r_t	0 SOP < OP	0 SOP < OP
Change in ϵ_t	+ SOP > OP	- SOP > OP
Change in e_t	+ SOP > OP	- SOP > OP
Change in NX_t	+ SOP > OP	- SOP > OP

29.4 Effects of Foreign Shocks in the Open Economy New Keynesian Model

In this section, we consider the effects of changes in exogenous variables which are foreign to the domestic economy. These include r_t^F (the foreign real interest rate), Q_t (a variable which we take to be exogenous which shifts the demand for net exports), and P_t^F , the foreign price level. Changes in P_t^F have no effect on real domestic endogenous variables, and only result in a change in the nominal exchange rate. We will again focus on the simple sticky price model in which the AS curve is horizontal.

29.4.1 Increase in r_t^F

First, consider the effects of an increase in r_t^F , the foreign real interest rate. For a given r_t , an increase in r_t^F results in a reduction in $r_t - r_t^F$. This leads to a depreciation of the home currency and an increase in the demand for net exports. An increased demand for net exports results in the IS curve shifting out to the right. These effects are depicted graphically in Figure 29.7.

Figure 29.7: Effect of an Increase in r_t^F

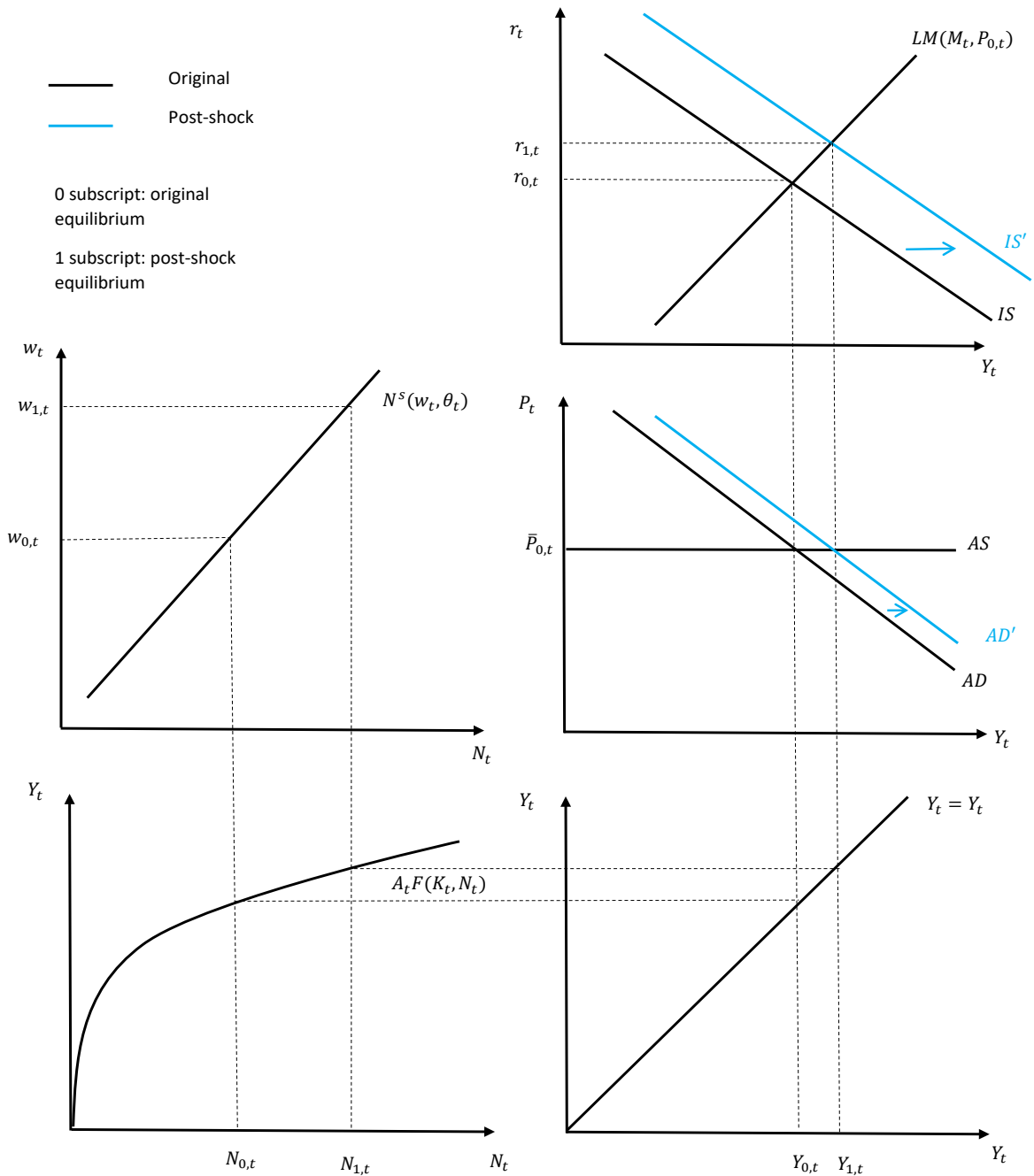

The rightward shift of the IS curve results in the AD curve shifting to the right. r_t and Y_t increase. Because Y_t is higher, labor input must be higher. Since the real wage is determined from the labor supply curve, this means that the real wage must rise.

How does the rise in r_t compare to the exogenous increase in r_t^F , and in turn what happens to the real exchange rate and net exports? To see this, suppose that the LM curve were

vertical. In this case, r_t would increase with no change in Y_t . The increase in r_t would drive I_t down. The increase in r_t combined with no change in Y_t would mean that C_t would also be lower. Since $Y_t = C_t + I_t + G_t + NX_t$, if there were no change in Y_t and no change in G_t (since it is exogenous), NX_t would have to increase, which would mean that $r_t - r_t^F$ would have to decrease (i.e. r_t rising by less than r_t^F). Hence, even if the LM curve were vertical, r_t would have to rise by less than r_t^F , which means that ϵ_t would have to rise (i.e. depreciate), which would result in NX_t increasing. Since the LM curve is not, in general, vertical, we can conclude that r_t will rise by less than r_t^F , the ϵ_t will increase, and that net exports will increase when r_t^F increases.

29.4.2 Increase in Q_t

Next, consider an increase in Q_t . This variable is taken to be exogenous, and it is defined such that an increase in Q_t raises the demand for net exports. The increase in Q_t thus results in an outward shift of the IS curve. This is depicted graphically in Figure 29.8. Qualitatively, the graph looks exactly the same as Figure 29.7. Output and the real interest rate rise. Labor input and the real wage rise as well.

Figure 29.8: Effect of an Increase in Q_t

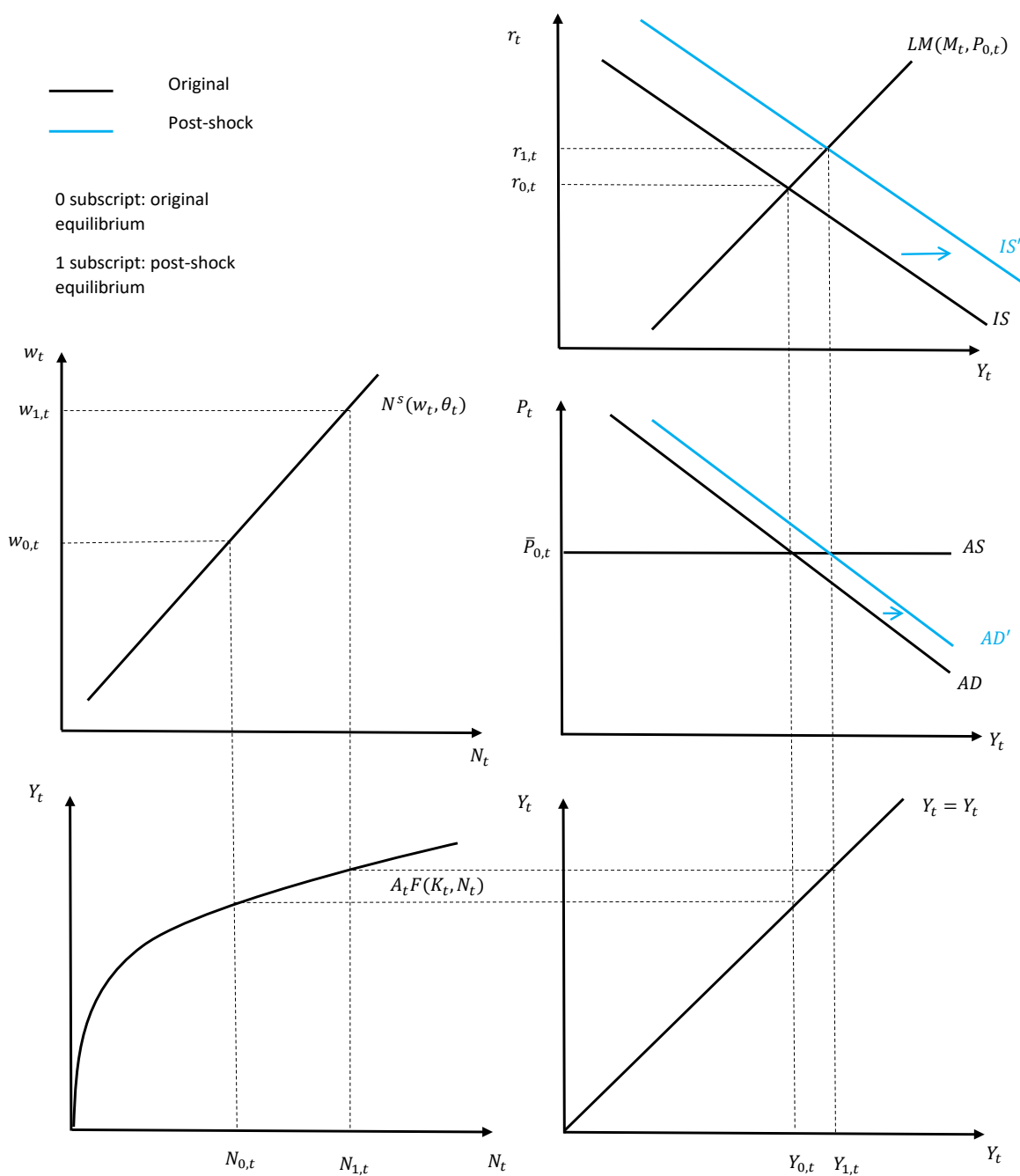

What happens to net exports and the real exchange rate? Since r_t increases but r_t^F is unaffected, $r_t - r_t^F$ increases, which from (29.10) causes the real exchange rate to fall (i.e. appreciate). This would ordinarily put downward pressure on net exports, the effect of Q_t works to counter this effect. What happens on net? To see this, as in the case of an increase in r_t^F suppose that the LM curve were vertical. If this were the case, r_t would increase

but there would be no change in Y_t . This means that C_t and I_t would both decline. Since $Y_t = C_t + I_t + G_t + NX_t$, it must be the case that NX_t increases. This means that even if the LM curve were vertical, the appreciation of the real exchange rate would not completely offset the direct effect of Q_t on NX_t , and NX_t would still rise. With a non-vertical LM curve, the increase in r_t is smaller than in the case where the LM curve is vertical, and hence the appreciation of the real exchange rate is smaller, so net exports will rise by more than when the LM curve is vertical. We conclude that net exports must rise when Q_t increases, and the real exchange rate must fall (i.e. depreciate).

29.5 Fixed Exchange Rates

Thus far in this chapter, we have been focusing on an economy in which the exchange rate is allowed to “float,” which simply means that the exchange rate is an endogenous variable. In the last forty years, most developed economies have allowed their exchange rates to float (at least within certain bounds). This was not always the case. From the end of World War II until 1971, most developed economies operated under a fixed exchange rate system, which operated according to the [Bretton Woods](#) agreement. In particular, under Bretton Woods, most western developed economies agreed to operate their money policy by fixing their exchange rates to one another.

Under a system of fixed exchange rates, an economy’s central bank targets an exogenous value of the exchange rate (both real and nominal, to the extent to which the price level is fixed, as we assume in the sticky price model). Call the exogenous target value of the real exchange rate ϵ^* . From (29.10), the following must then hold:

$$\epsilon^* = h(r_t - r_t^F) \quad (29.12)$$

Since r_t^F is exogenous, and ϵ^* is now exogenous, this is one equation in one unknown. We can solve for r_t in terms of the two exogenous variables as:

$$r_t = h^{-1}(\epsilon^*) + r_t^F \quad (29.13)$$

In (29.13), $h^{-1}(\cdot)$ denotes the inverse of the function $h(\cdot)$. (29.13) does not require that r_t equal r_t^F (depending on what ϵ^* is), but does imply that r_t will have to move one-for-one with changes in r_t^F for a given target exchange rate, ϵ^* . To implement this target real interest rate, the central bank must adjust the money supply so as to be consistent with this. In other words, if a central bank commits to a fixed exchange rate, it loses control over its own monetary policy. The central bank cannot simultaneously adjust M_t to target both r_t and ϵ_t .

If it wants to use monetary policy to control r_t (effectively what we considered in the analysis above), it must allow ϵ_t to float. If it wants to target $\epsilon_t = \epsilon^*$ instead, it must adjust the money supply (and hence the domestic real interest rate) so as to be consistent with (29.13) holding.

Under a system of fixed exchange rates, we cannot therefore consider an exogenous change in the money supply without a change in the target exchange rate. We can consider how shocks to the IS curve will affect endogenous variables of the model. The way we will proceed is as follows. We will consider a shock to the IS (resulting from changes in domestic exogenous variables) curve, and will determine what would happen to the endogenous variables of the model with the money supply fixed, and the exchange rate implicitly allowed to float. Then we will figure out how the money supply must adjust so as to keep the exchange rate fixed. From (29.13), this effectively amounts to conducting monetary policy so as to keep real interest rate fixed (so long as the foreign real interest rate is fixed).

Figure 29.9 carries out a graphical analysis of a positive IS shock under a system of fixed exchange rates. The black lines and 0 subscripts denote the initial, pre-shock equilibrium. The blue lines show how curves would shift with the money supply fixed (i.e. floating exchange rates), and the equilibrium values after this shift are denoted with 1 subscripts. The red lines show how curves shift when monetary policy reacts to keep the real interest rate (and hence the exchange rate) fixed. The equilibrium values after this policy response are denoted with 2 subscripts.

Figure 29.9: A Positive IS Shock and a Fixed Exchange Rate Regime

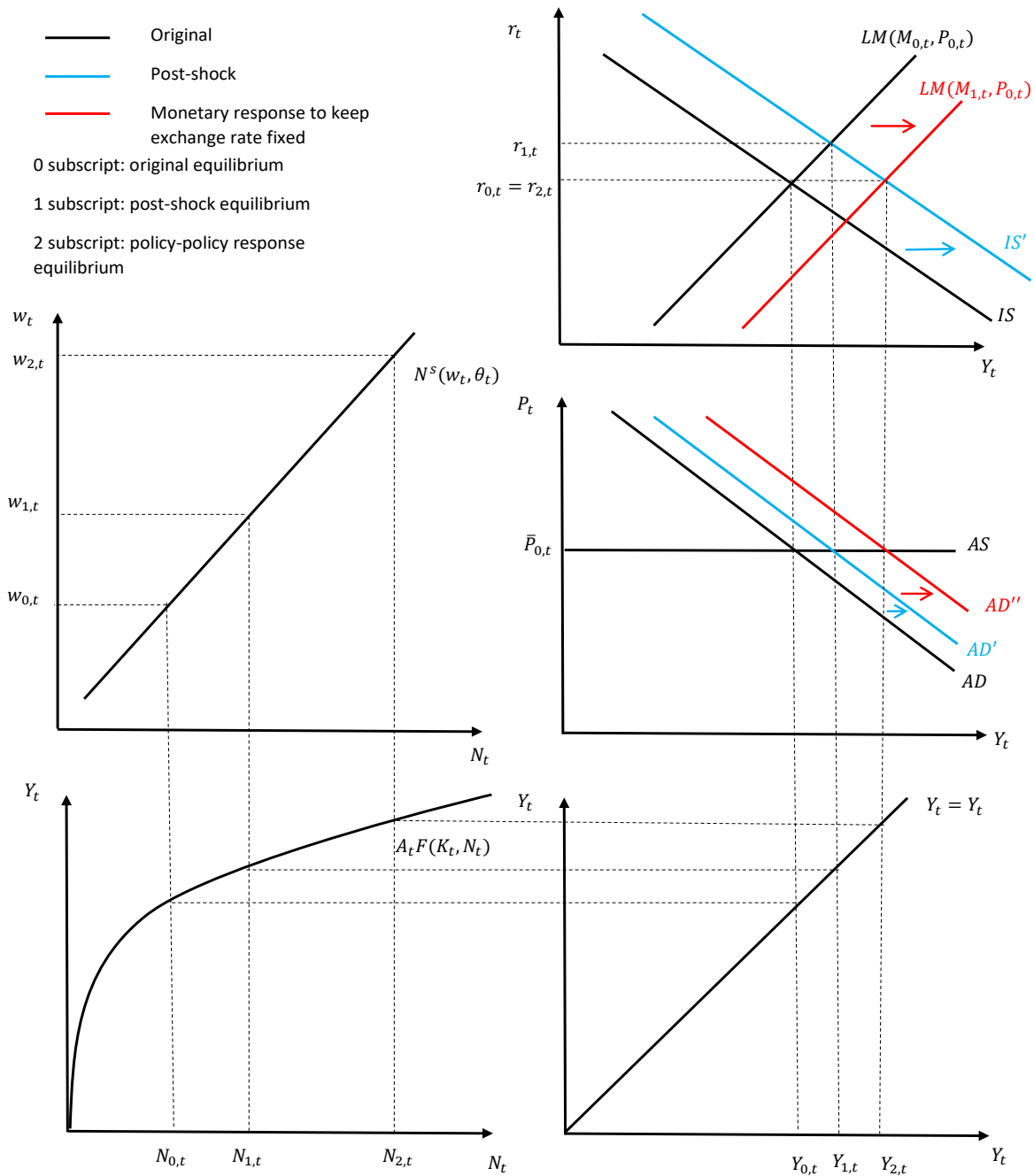

The IS shock causes the IS curve and hence the AD curve to shift to the right (shown in blue). This would ordinarily result in an increase in the real interest rate and a resulting appreciation of the currency (i.e. ϵ_t declining). Output, labor input, and the real wage would rise. To keep the exchange rate from changing, the money supply must adjust so as to keep the real interest rate fixed. Hence, in this example, the money supply must increase. This

results in the LM curve shifting to the right (depicted in red), which triggers an even bigger outward shift of the AD curve (also shown in red). Compared to a situation with exogenous monetary policy, output rises by more. This means that labor input and the real wage also rise by more.

Under a system of fixed exchange rates, we can thus conclude that IS shocks have bigger effects on output than under a system of floating exchange rates. In a sense, one can think about the fixed exchange rate model as being very similar to the closed economy model with a binding zero lower bound. As in the case where the ZLB binds in an open economy, the real interest rate is fixed under a fixed exchange rate regime. This means that shocks to the IS curve have bigger effects output, and that conventional monetary policy is ineffectual.

Consider next the effects of an increase in r_t^F from $r_{0,t}^F$ to $r_{1,t}^F$. Since the domestic real interest rate must satisfy $r_t = h^{-1}(\epsilon^*) + r_t^F$, the increase in r_t^F requires that the central bank adjust its monetary policy in such a way as to increase the domestic real interest rate by the same amount as the foreign real interest rate. Since $r_t = r_t^F$, unlike in the case of a floating exchange rate, there is no increase in the demand for net exports and no IS shift, unlike what is depicted in Figure 29.7.

The effects of the increase in r_t^F under a system of fixed exchange rates are depicted in Figure 29.10. To keep its exchange rate fixed, the central bank must reduce the money supply in such a way that the domestic real interest rate increase by the same amount as the increase in the foreign real interest rate. This results in an inward shift of the AD curve (shown in blue). Output declines. The output decline necessitates a reduction in labor input and a reduction in the real wage. This example underscores the fact that a country loses independent control of its monetary policy under a system of fixed exchange rates – it must move its real interest rate in lock-step with other countries to keep its exchange rate fixed.

Figure 29.10: An Increase in r_t^F in a Fixed Exchange Rate Regime

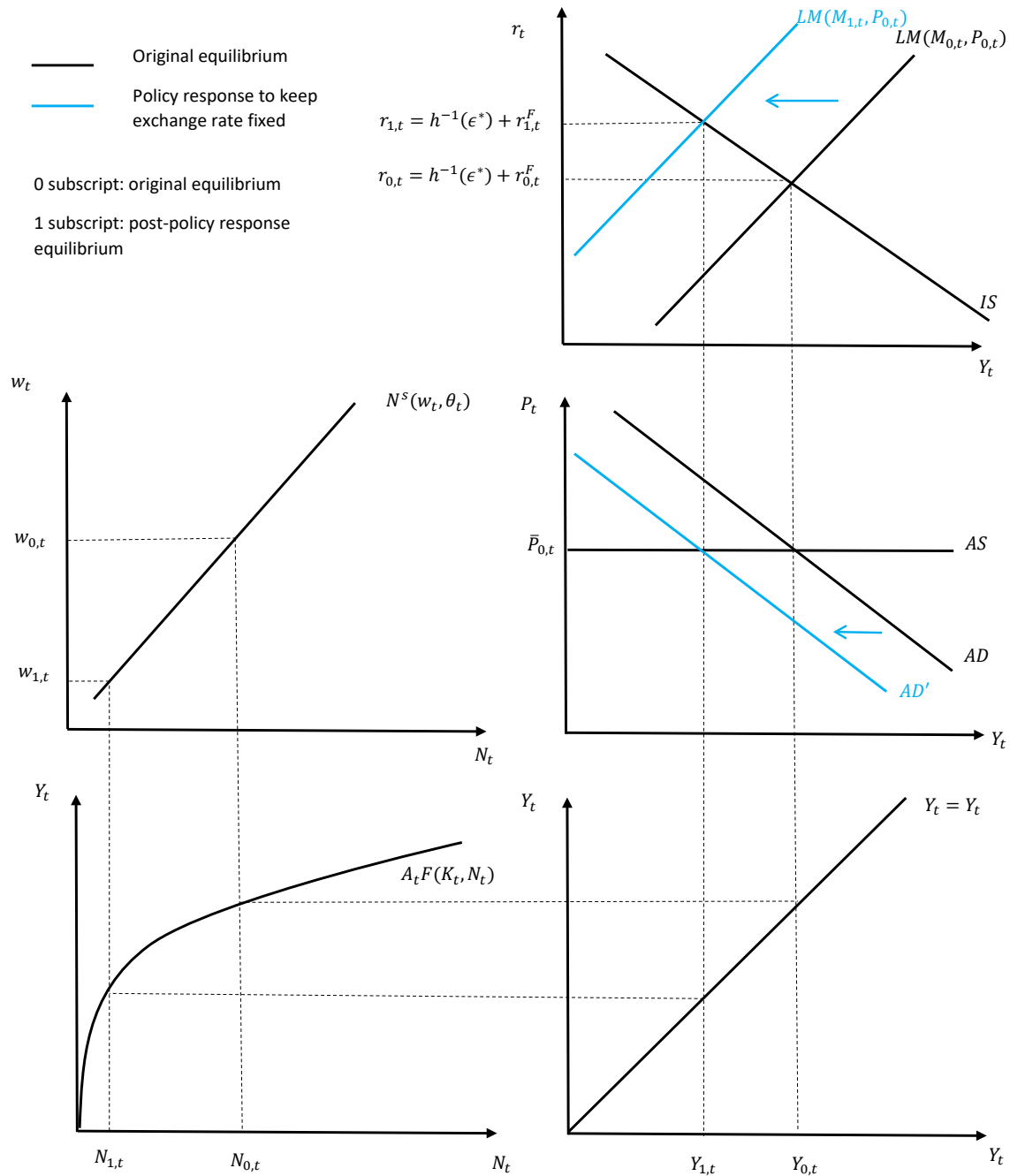

From the perspective of our model, fixed exchange rates are a bad idea. This is clear from (29.9). If the objective of a central bank is to implement the hypothetical, neoclassical equilibrium (which we explored in the open economy case in Chapter 22), it must be able to adjust the money supply (and hence interest rates) in response to domestic economic shocks. Furthermore, a system of fixed exchange rates exposes an economy to potentially large swings

in interest rates and output, as we can see in Figure 29.10.

If fixed exchange rates are a bad idea from the perspective of our theoretical framework, then why have we observed countries implementing fixed exchange rate regimes in the past, and why do some continue to do so today? Arguments in favor of fixed exchange rates rely on elements of reality which are not captured in our model. Some of these are discussed below:

1. A country's exchange rate could be quite volatile if it is allowed to float. This is particularly true for relatively small economies. This volatility in exchange rates could increase uncertainty, and could pose problems for businesses involved in importing and exporting in that contracts might have to be set in advance. If the exchange rate fluctuates a lot, setting a contract in advance based on an expectation of the prevailing exchange rate which turns out to be wrong after the fact exposes businesses to significant risk.
2. In a floating exchange rate regime, exchange rates are potentially subjective to non-fundamental speculations. For example, large financial institutions (such as hedge funds) frequently trade foreign exchange, hoping to make a profit. If a country is small enough, its exchange rate could be subject to large swings that are not rooted in economic fundamentals, but rather in terms of irrational speculation by large institutions. Related to the point above, this volatility in exchange rates could be bad for an economy's health.
3. A country may want to artificially weaken its currency to achieve export led development. This is particularly true for very poor and relatively undeveloped countries, many of which achieve growth through exports. A weak currency strengthens their export competitiveness. A recent example of a country trying to grow through artificial downward manipulation of its currency is China, which pegged its currency at an artificially low level throughout much of the 1990s and early 2000s.

A [currency union](#), which is a situation in which multiple sovereign governments team together to use a single, common currency, is an example of a fixed exchange rate regime. The states in the US constitute an example of a currency union – one dollar in Nevada exchanges for one dollar in Texas. An example with which you are probably familiar is the [Eurozone](#). Close to 20 European countries have adopted a common currency, the euro. This means that one euro in France exchanges for one euro in Italy. Effectively, by adopting a common currency, France and Italy (and all the other countries in the Eurozone) are fixing their exchange rates.

The argument in favor of a common European currency is essentially one of convenience. Since European countries are relatively small, they trade extensively with one another. A common currency makes this trade significantly easier. Traveling within Europe is also now much easier for individuals, who do not have to worry about exchange rate fluctuations or exchanging one currency for another. The obvious drawback of the currency union, related to what we discussed above, is that individual countries had to effectively cede control of their own monetary policy upon adopting the common currency. Monetary policy in the Eurozone is now conducted by the European Central Bank, rather than individual countries' central banks. This can, and has, proven problematic to the extent to which economic conditions in the various member countries are not well-synchronized. During the recent Great Recession, countries like Greece experienced severe economic downturns, whereas other countries, like Germany, performed comparatively well. What would have been good monetary policy for Greece was not necessarily good for Germany. Many argue that the currency union exacerbated the effects of the recession in many European economies, like Greece.

Why does the currency union work relatively well in the US, but may be prone to problems in Europe? In the US, all states speak the same language, and for this and other cultural reasons labor is more mobile across state lines than it is in Europe. This means that it is possible for workers in a particularly hard hit region to move to another region, which works to reduce regional differences in economic performance. In practice, economic conditions across US states are far more synchronized than are conditions across European countries. Another advantage which the US has which is absent in European is a centralized fiscal authority. The US can make use of aggregate fiscal spending and transfers to smooth out economic conditions across states. The Eurozone, in contrast, has a weak centralized fiscal authority.

A problem related to its lack of a centralized fiscal authority in Europe is one of sovereign debt crises. In Greece, for example, the period immediately after the Great Recession was one in which Greek government debt soared, raising concerns about the solvency of the country. This has debilitating economic consequences. If Greece had control of its own monetary policy, it could have engaged in highly expansionary monetary policy, which would in effect allow it to default on some of its debt obligations via inflation. While an inflationary default comes with its own costs, it likely would have both shortened the length, and reduced the severity, of the sovereign debt crisis. Because it did not have control over its own monetary policy, this path was not an option for Greece. For this reason, many people at the time argued that Greece ought to leave the Euro, thereby regaining control over its own monetary policy.

29.6 Summary

- The open economy AD curve is flatter than the closed economy AD curve. The supply side is not affected.
- A monetary expansion lowers the real interest rate which reduces the real exchange rate and stimulates net exports. This is an additional monetary transmission mechanism relative to the domestic economy. Consequently, increases in the money supply are more expansionary in the closed economy. Conversely, expansionary shifts in the IS curve have less of an effect on output in the open economy compared to the closed economy. The reason is that a positive IS shock raises the real interest rate, which reduces the real exchange rate and lowers net exports.
- In a small open economy the monetary transmission mechanism happens entirely through the net exports channel. Conversely increases in the IS curve that cause one spending component to increase are completely offset by reductions in net exports.
- In a fixed exchange rate regime, the nominal exchange rate is fixed. The money supply is continually adjusted to always hit this exchange rate peg. A consequence of this is that monetary policy loses its discretion to react to other shocks. If the goal of monetary policy is to implement the Neoclassical equilibrium, fixed exchange rates are a bad idea. However, there may be beneficial reasons to pegging the exchange rate which we have omitted from the model.

Questions for Review

1. Consider the following statement. “The effects of exogenous shocks in the open economy version of the New Keynesian model are generally between those in the closed economy and those in the small open economy.” Would you agree with this statement? Explain.
2. List a couple of reasons why a fixed exchange rate regime might be desirable, focusing on features which are not present in our model.
3. Elaborate on a couple of reasons why a currency union is likely a better idea in the United States than in Europe.
4. Explain why changes in G_t will have a bigger effect on output with fixed exchange rates compared to floating exchange rates.
5. Is an economy more or less affected by changes in r_t^F under a system of fixed or floating exchange rates? Explain.

Exercises

1. Derive the AD curve under three different scenarios, all in the same graph:
 - (a) A closed economy
 - (b) An open economy
 - (c) A small open economy

Comment on the differences in the AD curve under each regime.

2. Suppose that monetary policy wants to implement the neoclassical equilibrium in response to exogenous shocks. Consider a positive shock to the IS curve from a domestic exogenous variable (e.g. an increase in G_t). Will the central bank have to adjust the money supply (and interest rates) by more or less in the open economy or the closed economy to implement the neoclassical equilibrium? Show graphically and discuss.
3. Suppose that an economy wants to implement a fixed exchange rate regime, but wants to use changes in government spending to implement it rather than monetary policy. Show how G_t must react to IS shocks (e.g. a change in A_{t+1}) as well as a positive supply shock (e.g. an increase in A_t).

Part VI

Money, Credit, Banking, and Finance

Many textbook presentations of macroeconomics abstract from issues related to banking and finance altogether. Most all of our analysis up to this point follows suit. Nevertheless, the recent financial crisis and ensuing Great Recession have reminded economists of the important linkages between the financial system and the macroeconomy. This section of the book addresses a subset of these issues in some detail. Much of the material in this section is ordinarily reserved for textbooks on money, credit, and banking. In that sense, our attempt to incorporate these issues into a macroeconomics text is reminiscent of [Ball and Mankiw \(2011\)](#).

Banks play an important role in intermediating credit from savers to borrowers. [Chapter 30](#) discusses the basic business of banking. There we discuss the two principal reasons economists have advanced for the importance of financial intermediation – that banks help ameliorate informational asymmetries between borrowers and savers and that banks engage in the important process of liquidity transformation, though the bulk of the discussion concerning liquidity transformation is delegated to a separate chapter, [Chapter 32](#). In [Chapter 30](#) we introduce the concept of a bank balance sheet and use T-accounts to discuss adjusting assets and liabilities so as to manage credit and liquidity risk. We also include a discussion of how the banking system has changed in the last several decades and in particular discuss the rise of the so-called “shadow banking system,” which we broadly take to mean financial firms engaged in credit intermediation which are nevertheless not traditional depository institutions. [Chapter 31](#) builds off the T-accounts introduced in [Chapter 30](#) to discuss the process through which the supply of money is set. This provides background analysis for other parts of the book which treat the money supply as an exogenous variable which central banks can easily manipulate.

[Chapter 32](#) discusses the role of banks in liquidity transformation, by which we mean taking funds from savers, investing in longer term illiquid projects, yet at the same time providing savers with liquid assets like demand deposits. We proceed by working through a couple of simple examples and show how liquidity transformation can make risk averse households unambiguously better off. But we note how the process of liquidity transformation leaves banks prone to periodic runs in which liabilities dry up and the bank is unable to liquidate all of its investments. In so doing we provide a simplified version of the classic [Diamond and Dybvig \(1983\)](#) model of bank runs. We discuss policies to reduce the frequency and severity of banking panics and provide some historical context. Some of the work in this chapter is useful, though not entirely necessary, for understanding the Great Recession, which is discussed in depth in [Chapter 36](#).

[Chapters 33](#) and [34](#) are dedicated to asset pricing. [Chapter 33](#) studies bond pricing and [Chapter 34](#) stocks. We do so in the context of a [Lucas \(1978\)](#) endowment economy model

in which assets are held in zero supply (which is in turn similar to our analysis in Chapter 11). An asset's price depends on the expectation of the product of the stochastic discount factor with the expected future cash flows from holding the asset. As a result, the yield (or expected return on an asset) depends on how that asset's cash flows co-vary with the stochastic discount factor. Chapter 33 uses this framework to discuss both the term and risk structure of interest rates. The concept of a yield curve is introduced and the expectations hypothesis, as well as the expectations hypothesis allowing for a term premium, are discussed. We include a discussion comparing and contrasting conventional and unconventional monetary policy, which is later discussed in more detail in Chapter 36. Chapter 34 introduces the concept of the equity premium and uses our modeling framework to argue why one ought to expect stocks to return more (in expectation) than riskless government bonds. We also define and discuss bubbles and present some empirical evidence related to bubbles.

Chapter 35 discusses how one might incorporate, in a relatively straightforward way, financial frictions into an otherwise standard macroeconomic framework. We argue that a sensible way in which to do this is to incorporate an exogenous credit spread variable measuring a spread between what the representative household receives for saving and what the representative firm must pay to do more investment. Exogenous fluctuations in this spread variable can be a source of shocks (in either the New Keynesian or neoclassical models) in that they shift the *IS* and hence *AD* curves. We argue that financial panics are times in which there is heightened demand for liquid, comparatively safe assets, which leads to an increase in credit spreads and a decline in aggregate demand. We also show how this framework can be modified in such a way as to include a “financial accelerator” mechanism (Bernanke, Gertler, and Gilchrist 1999) in which the credit spread depends on the output gap.

Chapter 36 discusses financial crises with a particular focus on the recent Great Recession. We provide some background information on the Great Recession and discuss how the financial panic that followed from losses in the housing market closely resembled a classic banking panic. In this way, the material in this chapter partially builds off of the work in Chapters 30 and 32, but is presented in such a way as to be self-contained. We use the New Keynesian AD-AS model, augmented to include financial frictions as presented in Chapter 35, to think about the Great Recession as a financial crisis manifested in increases in credit spreads and exacerbated by a binding zero lower bound. We use this framework to discuss the myriad unconventional policy responses that were taken in the Great Recession's aftermath. Although this material on policy is presented in a way so as to be self-contained, it is related to the analysis from Chapter 33.

Chapter 30

The Basics of Banking

The financial system in the United States and other developed nations is large and complex. At a fundamental level, the financial system funnels savings into investment. We refer to this as financial intermediation, and it is highlighted in Figure 30.1 below. This is an extremely important function, and many economists blame underdeveloped financial systems for the low levels of productivity observed in very poor countries. With underdeveloped financial systems, talented but poor individuals are unable to secure loans to develop their ideas into businesses. With some of society’s most talented people being prevented from innovating, overall productivity decreases.

Figure 30.1: Financial Intermediation

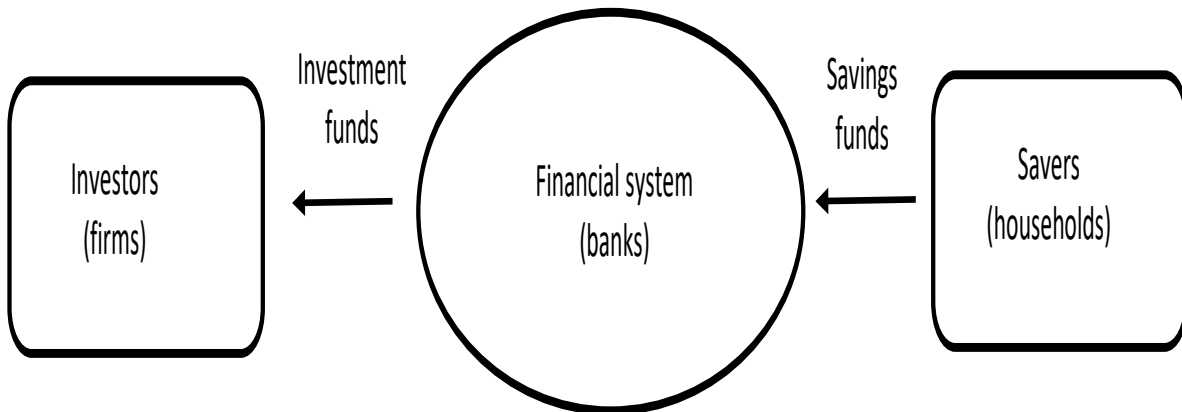

The financial system is composed of many different types of firms – commercial banks, investment banks, bank holding companies, insurance companies, pension funds, and hedge funds, to name a few. These different types of firms differ slightly in the specifics of the business activities they undertake, but they all play a similar fundamental role of intermediating credit between savers (typically, households) and investors (typically, firms). In this chapter we will repeatedly refer to such an intermediary as a “bank,” even though for regulatory purposes there are many financial firms which are not officially designated as banks but which engage in credit intermediation.

The basic business of banking involves a bank borrowing funds from savers and then lending out those funds to investors. In other words, the bank (or the financial system more generally) intermediates credit from savers to borrowers. While there are exceptions, particular for very large and established firms, the most reliable source of investment funds for many firms are conventional bank loans. Why is this the case? Economists focus on two principal reasons for the existence and importance of financial intermediaries. The first reason is one of asymmetric information, which will be discussed in Section 30.1 below. Asymmetric information means that investors are more informed about their own activities than are savers. For this reason, savers are leery to give funds directly to firms, and banks (or other financial intermediaries) step in and play an important role in ameliorating informational asymmetries between savers and borrowers.

The second principal reason advanced by economists for the existence of banks is that banks play an important role in what is called liquidity transformation (or sometimes maturity transformation). The liquidity of an asset refers to the ease with which it can be converted to a medium of exchange (i.e. money), and hence used in transactions, quickly and without affecting the price of the asset. Most investment projects are illiquid in the sense that, if \$100 million is invested in a building, that \$100 million cannot be easily converted back to cash – it is tied up in the construction of the building, the returns from which will not be received for some time in the future. Households have a preference to save in comparatively liquid assets because households are not entirely sure of when their spending needs will arise. For example, if there is a chance that you will be injured in a car accident tomorrow and will need \$10,000 cash, you'd prefer to have \$10,000 sitting in a bank account (which is an extremely liquid asset) compared to all tied up in your home (the liquidation of which would take time, involve fees, and would result in an uncertain amount of funds). Banks, or financial intermediaries more generally, can engage in what economists call liquidity transformation by taking funds from savers, funneling those funds to firms investing in relatively illiquid (and generally longer term) projects, while at the same time creating liquid assets that households desire. Liquidity transformation, and the susceptibility of banks and the financial institutions to periodic runs, are discussed more formally in Chapter 32.

In this chapter we will mostly focus on a simplified framework in which a bank takes in funds from savers in exchange for what are called demand deposits (i.e. checking accounts). Demand deposits are perfectly liquid in that they can be used to exchange goods and services. Demand deposits are also short term in that they can be redeemed for currency at any time (i.e. “on demand”). The bank takes these funds and lends them out to firms. The loans to firms are generally less liquid than deposits (while loans can be sold and often are, it may be difficult to do so quickly and at a fair price) and are longer term (i.e. the loan is extended

for a number of years over which the borrower will be expected to pay the funds back). For this reason, it is often said that banks “borrow short and lend long,” where “short” and “long” refer to the maturities of deposits and loans, respectively. Banks earn profits by paying less for deposits (or for liabilities more generally) than they earn on their loans (or their investments more generally). In terms of mathematical notation introduced earlier in the book we can think about banks paying a (real) interest rate of r_t on deposits and lending out to firms at a (real) interest rate of $r_t^I = r_t + f_t$, where f_t is the spread between the rate on deposits and the rate on loans. As long as f_t is relatively stable thinking about there being one interest rate in the economy, as we have done throughout the book, is not a bad simplifying assumption. Of course, for a variety of different reasons this spread could in fact change, as we discuss in Chapters 35 and 36. There is a famous joke that bankers follow the “3-6-3 rule” – they pay depositors 3 percent interest, they charge 6 percent interest on loans, and they are on the golf course by 3 pm.

We will discuss some more complicated features of the modern banking system in Section 30.4, particular the rise of non-bank financial intermediaries, which we will generically refer to as “shadow banks.”

30.1 Asymmetric Information: Adverse Selection and Moral Hazard

One principal reason that financial intermediation is so important is because of asymmetric information between savers and borrowers. Asymmetric information refers to any situation in which two parties to a transaction are not equally well-informed about one another. The two main kinds of asymmetric information emphasized by economists are *adverse selection* and *moral hazard*. The easy way to remember the distinction between the two is that adverse selection is a type of informational asymmetry which plagues transactions before they take place, whereas moral hazard occurs after a transaction has taken place. It will be easiest to introduce these concepts through examples.

The concept of adverse selection was famously studied by Akerlof (1970). He studied the issue of adverse selection by focusing on the market for used cars. We will illustrate an example inspired by his paper, and then discuss how adverse selection is potentially important for financial intermediation. You have probably heard the term “lemon” used to describe a car that functions poorly. In the example we will pursue here, we will assume that there are two kinds of cars – lemons which are plagued by mechanical malfunctions, and “peaches” which work well and are comparatively maintenance-free. An owner of a car knows which kind of car she owns – i.e. whether the owner has a lemon or a peach. Potential buyers, in

contrast, are not as well-informed. They cannot tell whether a car for sale is a lemon or a peach. There is an information asymmetry in that one party to the transaction (the potential buyer) is less well-informed about the characteristics of the object to be sold than the other side of the transaction (the seller).

Suppose that potential buyers and sellers of used cars have the following dollar valuations of peaches and lemons as shown in Table 30.1:

Table 30.1: Potential Buyer and Seller Valuations

Car Type	Seller	Buyer
Peach	\$15,000	\$18,000
Lemon	\$10,000	\$12,000

The numbers in the Table 30.1 reflect the respective valuation of each type of car by both potential buyers and sellers. In both cases, a potential buyer values a car more than the seller does. This means that with symmetric information, there would be gains from trade and we would expect both types of cars to be sold – peaches would sell for between \$15,000 (the minimum the seller would accept) and \$18,000 (the maximum a buyer would be willing to pay). Lemons would sell for between \$10,000 and \$12,000. The exact split of surpluses between buyers and sellers is not important. The important point is that both kinds of cars would sell.

But what would happen if there were asymmetric information? In particular, suppose that a potential seller knows the type of her car. But a buyer does not know the type of the car of any seller that he encounters. The buyer only knows that a fraction, $q \in (0, 1)$, of all cars are lemons – the other $1 - q$ are peaches. A potential seller also knows the fraction of cars that are lemons, and furthermore knows that potential buyers know this fraction as well. The maximum amount a potential buyer would be willing to pay for a car is equal to the expected valuation from a buyer’s perspective, which would work out to $q \times 12,000 + (1 - q) \times 18,000$. Suppose that $q = 0.6$, so that 60 percent of cars are known to be lemons. Then the expected valuation is \$14,400. This is \$600 less than minimum price the owner of a peach would accept for her car. Because the maximum an uninformed buyer would be willing to pay is less than the minimum amount the seller of a peach would accept, peaches will not be sold. But then potential buyers will know that owners of peaches are not willing to sell their cars, and only lemons would be sold. The market breaks down and only the low quality cars are traded.

This example nicely illustrates the deeper concept of adverse selection, which is that the presence of bad sellers in a market (in this case, lemons) can potentially drive good sellers out of the market (in this case, peaches). The concept of adverse selection can also be applied to

a situation in which firms seek to raise investment funds directly from households, rather than through a financial intermediary. Let us again proceed with an example. Suppose that there are two types of firms – for simplicity, call them “safe” and “risky.” These firms need \$1 to engage in an investment project. With certainty, if the good firm gets \$1, it will generate \$1.20 of income in the next period. Things are not this way for the risky firm. With probability of $\frac{1}{2}$ its project will succeed and will generate \$1.50 of income in the next period. But with probability of $\frac{1}{2}$ the project will fail completely, and the invested dollar will be lost.

There is a household who has \$1 to save, with an outside option of just storing the \$1. To make matters as simple as possible, suppose that there is no discounting of future payoffs relative to current payoffs. The household can make a loan to a firm at (real) interest rate r – in the event the project succeeds, the household gets its principal plus interest back, so the household receives future income of $1 + r$. If the project fails, the household gets nothing in return. Suppose that a household is willing to make a loan so long as its expected return is non-negative. The expected return of making a loan to the safe firm is simply r (i.e. $1 + r - 1$, where the -1 is netting out the upfront cost of making the loan). The expected return of making a loan to the risky firm is $\frac{1}{2}r - \frac{1}{2}$.

If there were perfectly symmetric information, would the household fund either type of firm? In answering this question, it is important to note that, because of limited liability, a firm only cares about what happens should the investment project succeed. For the safe firm, this means that the firm would take a loan with any interest $r \leq 0.2$ – if $r > 0.2$, the firm would lose money by getting the loan. The household would be willing to make a loan to the safe firm for any $r \geq 0$. This means that the safe firm would get a loan for an interest rate somewhere between 0 and 20 percent (as in the case of the lemons and peaches example, the exact split of surplus between the household and firm is irrelevant). What about the risky firm? The risky firm would accept a loan for any interest rate less than or equal to 50 percent (i.e. $r \leq 0.5$) – if the project succeeds, the firm earns some profit, and if it fails, the firm does not care. What about the household? From above, for the household’s expected return to be non-negative, we must have $r \geq 1$. In other words, with a 50 percent probability of failure, the household would only be willing to make a risky firm a loan with an interest rate of 100 percent or more. But the risky firm would never accept such a loan. So we would be left with the outcome that safe firms get funding and risky firms do not.

Now consider a case of asymmetric information that is analogous to the used car market. A household with a \$1 to save cannot tell safe firms apart from risky firms – firms know whether they are risky or safe, but households do not. A household only knows that there is a probability, again call it q , that a firm is risky, and a probability $1 - q$ that a firm is safe. Would the household be willing to lend money to a firm not being certain about what type

that firm is? It depends on how big q is. As an example, suppose that $q = \frac{1}{2}$ – that is, one half of firms are risky. The household’s expected profit from making a loan is then equal to:

$$E(\textit{profit}) = \frac{1}{2} \times r + \frac{1}{2} \times \left[\frac{1}{2}(r - 1) \right] \quad (30.1)$$

In (30.1), the r after the first $\frac{1}{2}$ is the expected return from lending to a safe firm, while the $\frac{1}{2}(r - 1)$ in brackets after the second $\frac{1}{2}$ is the expected return on lending to a risky firm. The two $\frac{1}{2}$ terms before the multiplication signs are the probabilities of lending to a safe and risky firm, respectively. For the expression in (30.1) to be non-negative, it must be the case that $r \geq \frac{1}{3}$. In other words, for a household to be willing to lend directly to a firm without knowing the firm’s type, given the probability structure the household would require at least an interest rate of 33.33 percent. But the safe firm would never take such a loan – that firm would only take an interest rate of 20 percent or lower. Hence, safe firms will not seek a loan. Risky firms would take a loan at an interest rate of 33.33 percent, but at that interest rate the household would know it is dealing with a risky firm, and would instead require an interest rate of 100 percent or more to make a loan. But then the risky firm would not take this loan. The market for funds would break down entirely – neither type of firm would be able to get a loan. In effect, the presence of the risky firm makes it such that the safe firm does not get a loan. But once that is the case, the household does not want to fund the risky firm, and no investment gets undertaken. This is adverse selection at work applied to a hypothetical financial market.

A potentially important role of banking (or financial intermediation more generally) is that a bank may develop expertise that allows it to overcome asymmetric information problems. You may have noticed that many, if not most, used cars are sold through dealerships rather than through personal transactions. The reason why is asymmetric information – an individual buyer will have a difficult time figuring out the true quality of a car, and is potentially willing to pay a little more to go through a dealer, where the dealer builds up expertise in discriminating between lemons and peaches and can even offer its stamp of approval to the quality of a car. Banks can potentially play a similar role. Banks become experts at evaluating the credit risks of potential borrowers in a way that is not feasible for an individual household. They can take in money from households and then use those funds to finance the best-looking projects. The household may be willing to pay a premium for this (in the form of a lower interest rate on its deposits) because it is comfortable that the bank will do a good job separating out good credit risks from bad.

The other type of asymmetric information on which economists focus is moral hazard, which is mentioned and defined above. Moral hazard is a type of information asymmetry that

happens after a transaction has taken place. Moral hazard problems emerge when parties to a transaction have different exposures to risk. Take car insurance, for example. If an insurer issues you a policy, you have less incentive (once insured) to drive carefully. Perhaps you are more likely to speed, less likely to park far away in parking lots from crowded areas, and the like. But knowing that once insured you have less incentive to try to reduce the risk of an accident, the insurance company will want to charge you more for insurance up front. If the problem is bad enough, you may find the price of insurance prohibitive and the market for insurance could break down.

A similar problem can occur in financial markets. One can see this with an example that is similar to the adverse selection example mentioned above, but with a slight relabeling of terms. Suppose that there is only one firm seeking a loan. But that firm has two different projects it can undertake – a safe project that returns \$0.20 on net with certainty, and a risky project that returns \$0.50 with probability $\frac{1}{2}$ and fails completely with probability $\frac{1}{2}$. There is limited liability in the sense that if the project fails, the firm loses nothing (whereas the lender does, which makes this example similar to the insurance example discussed above). Suppose that a lender makes a loan with an interest rate of $r = 0.1$. If the borrower takes the safe project, both he and the lender net \$0.1 with certainty (i.e. the project earns \$0.20 and the firm has to pay back \$0.1). If, instead, the firm undertakes the risky project, he will earn $\frac{1}{2}(0.5 - 0.1) = 0.2$ in expectation. This is higher than the expected return of undertaking the safe project. Hence, with $r = 0.1$, the borrower will prefer to “gamble” and go with the risky project. But the lender would lose money – with probability $\frac{1}{2}$ the lender would get back $r = 0.1$, but with probability $\frac{1}{2}$ the lender would lose the dollar entirely, for an expected return of $-\$0.45$. For this example, similar to the adverse selection example above, there is no r where both the lender and the borrower at least break even if there is no way for the lender to force the borrower to invest in the safe project. The loan market breaks down.

This is again a place in which financial intermediation can step in. In addition to evaluating credit risks prior to making loans (i.e. dealing with the problem of adverse selection), banks can also become experts at monitoring the behavior of borrowers once loans are made. Many bank loans include restrictions on how the funds can be used, and banks have the expertise to monitor and enforce such restrictions, both of which would be difficult if not impossible for an individual to do on his or her own. Another means by which banks can enforce good behavior by borrowers is that banks often have repeated interactions with the same borrowers. Knowing the repeated nature of their interactions, a borrower is more likely to behave in desirable ways once a loan is made because that borrower is likely going to seek a loan again in the future.

In summary, then, one reason that financial intermediation is so important is because

of the screening (adverse selection) and monitoring (moral hazard) roles that banks can serve. Without an intermediary playing these roles, households may find it undesirable to directly fund investment projects. As we will discuss in Chapter 32, another (and arguably more, given recent developments in financial intermediation) important function of banking is so-called liquidity transformation. Finally, there is another less exciting, though nonetheless important, reason for banking and financial intermediation related to the size and scope of most investment projects. Most investment projects require more funds than any one potential household has to save. By aggregating many smaller sources of savings, financial intermediaries can facilitate such projects being undertaken.

30.2 The Bank Balance Sheet

The key to analyzing the business of banking is what is called the balance sheet. The balance sheet describes the assets and liabilities of a bank, institution, or an individual. An asset is something which an agent owns which generates some flow payouts and/or which can be sold to generate cash. Examples of assets are things like stocks and bonds held by an individual – these are pieces of paper that entitle the holder to periodic cash flows. Another example of an asset is a house – this provides a flow benefit (the utility from living in the house or the rents that can be earned by leasing it out), and it can be sold to generate cash. Cash, held either in the form of currency or in a checking or savings account, is also an asset for the account holder. Liabilities are debts or obligations that an individual or institution owes to another individual or institution. For example, if you are taking out student loans, then these loans are a liability to you. The loans are an asset to the bank holding the loan, however, since holding the loans entitles the bank to payments of interest and principal. Similarly, money in your checking account is an asset to you, but a liability to the bank in the sense that the bank has to produce cash on demand should you choose to withdraw, or has to transfer funds to another bank should you write a check.

The basic business of banking is that banks fund themselves with liabilities (in the simplest and most traditional example, these liabilities are deposits) and invest in assets (which in the canonical example are loans to other individuals or businesses). The bank makes a profit if its liabilities cost less than its assets earn. Equity (also called net worth and/or financial capital) is defined as the difference between the value of an agent's assets and her liabilities. For example, suppose that you purchased a home with a \$300,000 mortgage loan and no money down. The home is now valued at \$350,000. You have \$350,000 in assets and \$300,000 in liabilities. Your equity is \$50,000.

We summarize the balance sheet of a bank (or any other individual or institution) with

what is called a T-Account. On the left hand side of the “T” we list the value of different assets. On the right hand side of the “T” we list the value of all liabilities. We list equity on the right hand side after all liabilities as a convention, where again equity is equal to the difference in the value of assets and liabilities. Initial equity investments for banks (or other institutions) can come either from a private cash investment by individual investors or by the issuance of stock to the public. Holding stock entitles an owner to their share of profits earned and their share of total assets in the event of the bank being closed and its assets liquidated.¹

For our purposes, there are three important asset categories for the typical bank. These are loans outstanding, securities held, and cash reserves. Loans are the usual individual and business loans which banks make. Securities comprise financial securities that banks may also choose to hold; for conventional commercial banks, these securities are limited to debt issued by governments. Cash reserves are cash stored in the vault of a bank or reserve balances which individual banks have with a central bank. Reserve balances are kind of like checking accounts for banks. We will discuss the important role of reserve balances more in Chapter 31. The two important forms of liabilities for a typical bank are deposits (for our purposes we will not seek to distinguish between checking and savings accounts) and borrowings. Borrowings denote borrowed money from any source other than deposits. For example, banks can borrow funds from other banks or from a central bank. The difference between the value of assets and liabilities is the bank’s equity.

The following T-Account provides an example balance sheet for a typical bank:

Table 30.2: T-Account for Hypothetical Bank

Assets	Liabilities plus Equity
Loans: \$100	Deposits: \$100
Securities: \$10	Borrowings: \$0
Cash Reserves: \$10	Equity \$20

As we discuss more in Chapter 31, commercial banks are required by law to maintain reserve balances equal to a fraction of total deposits. We will denote this required reserve ratio via the parameter rr , which we take to be exogenous. Suppose, for simplicity, that the reserve requirement binds in the sense that the bank will not want to hold more reserves than it is required to. So in this case, we are assuming a required reserve ratio of $rr = 0.1$, or 10 percent.

¹Typically equity holders are more “junior” claimants on a firm’s assets than are debt holders. In the event of bankruptcy, debt holders get paid first and then equity holders get any remaining value from the liquidated firm.

A balance sheet as described in a T-Account is static – it shows the condition of a bank at a point in time. As noted above, a bank makes money in a dynamic sense by earning more on the assets in which it invests than it pays for its liabilities. For example, suppose that a bank pays $r = 0.1$ for deposits and earns $r^L = 0.15$ on loans. Securities earn $r^S = 0.1$ and cash reserves pay nothing. Assuming that no loans default (i.e. fail to pay back) and that the market price of securities is unchanged, the bank will earn revenues of $0.15 \times 100 + 0.1 \times 1 = 16$ and will have total costs of $0.1 \times 100 = 10$. Its profit is the difference between revenues and costs, and in this case profit would be \$6. In a dynamic sense, the bank could either increase its equity (which would be reflected in higher stock prices) or return the profit to the equity holders in the form of dividends.

It is now useful to define a couple of terms. We can define a bank's *equity multiplier* as the ratio of its total assets to its total equity. In this example, the equity multiplier is $\frac{120}{20} = 6$. The higher the equity multiplier, the more of the bank's assets it is funding through credit (either in the form of accepting deposits or other borrowings) and the less the bank is funding its assets through equity. A related concept is the so-called *capital ratio*, which is simply the inverse of the equity multiplier (i.e. the ratio of total equity, also called financial capital, to total assets). Here the capital ratio is $\frac{20}{120} = \frac{1}{6}$. The *leverage ratio* is the ratio of a firm's liabilities to its equity, in this case $\frac{100}{20} = 5$. The leverage ratio conveys similar information to the equity multiplier – the higher it is, the more the bank is relying on debt to finance its assets. A bank's so-called *liquidity ratio* is the ratio of its liquid assets to its liabilities. We will consider cash and securities to be liquid assets in the sense that there are well-developed markets for securities and these securities can hence be converted to cash (i.e. liquidated) quickly and at little cost. Loans, in contrast, are less liquid. It may be possible to sell loans to a third party in order to raise cash, but doing so may be difficult and may involve taking a loss on the loan. We will return to this point more below. The bank's liquidity ratio is a measure of how easy a time the bank would have should it face unusually large withdrawals. The higher the liquidity ratio, the more easily the bank can accommodate withdrawals.

A bank's *return on assets* (or ROA for short), is its profit expressed as a fraction of its assets. In the example given above, the ROA would be $\frac{6}{120} = 0.05$. A bank's *return on equity* (or ROE for short) is its profit expressed as a fraction of its equity. In the example above, this would be $\frac{6}{20} = 0.30$. The ROA and ROE are related to the equity multiplier as follows:

$$ROE = EM \times ROA \quad (30.2)$$

A bank acting in its owners's best interests seeks to maximize its return on equity. For a given return on assets, the bank has an incentive to increase the equity multiplier, which equivalently implies increasing the leverage ratio. We can see this process at play by thinking

of an example with a homeowner and a mortgage. Suppose you buy a house valued at \$100,000 with \$20,000 down payment (your equity investment) and a \$80,000 mortgage loan. This is shown in the T-account below:

Table 30.3: T-Account for Homeowner

Assets	Liabilities plus Equity
House: \$100,000	Mortgage: \$80,000 Equity \$20,000

Suppose that the house appreciates in value to \$110,000, and ignore issues of interest owed on the loan. Your equity in the home increases one-for-one with the value of the home since the value of the outstanding mortgage is fixed. In this example, your equity would go from \$20,000 to \$30,000, for a return on equity of 50 percent. If you had instead financed the home with only \$10,000 of equity (and a \$90,000 mortgage loan), you would still get an increase in equity of \$10,000. But this would represent a return on equity of 100 percent (going from \$10,000 to \$20,000). If, in contrast, you had paid cash for the house (so equity equals initial house price of \$100,000), you would still earn \$10,000 when the value of the house appreciates. But this would only represent a 10 percent return on your investment. This process would also work in reverse if the house were to lose value. The important point is that more leverage (i.e. a higher equity multiplier) magnifies equity returns relative to asset returns. It does so in both the positive and negative direction – a high leverage ratio magnifies both positive returns and losses.

30.3 Managing the Balance Sheet

The objective of a bank is to maximize returns on equity. To do so, a bank chooses how to manage its balance sheet – in particular, what kinds of assets in which to invest, how much equity to raise, and what kind of liabilities to acquire. In managing its balance sheet, a bank must make accommodations both for what we will term *credit risk* – the risk that some of the assets in which it invests may underperform – as well as *liquidity risk* – the risks that liabilities will be drawn down (e.g. the bank faces an unexpectedly large withdrawal) in such a way that requires the bank to either have a large amount of cash reserves on hand or to quickly raise cash reserves. Balancing the objectives of maximizing the return on equity – which generally involves having significant leverage and holding few liquid assets – with dealing with credit and liquidity risk – which both call for a low leverage ratios and a high liquidity ratio, respectively – is the problem faced by a bank managing its balance sheet.

30.3.1 Credit Risk

Credit risk refers to the possibility that assets a bank holds on its balance sheet may underperform. The easiest example to think about is loans made. Some loans may default (i.e. the borrower does not pay the loan back), in which case the bank must realize a loss on its balance sheet by “writing off” the loan and accepting a reduction in equity. The general conclusion we can draw here is that having a higher capital ratio (equivalently, lower leverage) reduces the possibility of credit risk leading a bank into insolvency, which is defined as a situation in which a bank finds itself with negative equity (i.e. its assets are worth less than its liabilities).

To see this clearly, consider the following example balance sheet of a hypothetical bank, which is the same as considered above in Table 30.2:

Table 30.4: T-Account for Hypothetical Bank

Assets	Liabilities plus Equity
Loans: \$100	Deposits: \$100
Securities: \$10	Borrowings: \$0
Cash Reserves: \$10	Equity \$20

Suppose that some of the bank’s assets lose value. This could result from a reduction in the market value of the securities it holds, but it is most natural to think of loans issued going into default. In particular, suppose that \$25 of the bank’s \$100 loans go into default, forcing the bank to write this loan off as a loss. The balance sheet becomes:

Table 30.5: T-Account for Hypothetical Bank After Loan Default

Assets	Liabilities plus Equity
Loans: \$75	Deposits: \$100
Securities: \$10	Borrowings: \$0
Cash Reserves: \$10	Equity -\$5

The loss directly reduces bank equity. Since the loss in this example is greater than the bank’s initial equity, the loss forces the bank into insolvency, by which we mean a situation of negative equity. This means that the bank’s equity holders have effectively been “wiped out” and the bank cannot stay in business.

Somewhat mechanically, we can see that, holding the total size of the balance sheet fixed, a bank will be better situated to handle credit risk the more equity it has relative to liabilities – i.e. the lower is its leverage. Instead of that shown in Table 30.4, suppose instead that the bank’s initial balance sheet were:

Table 30.6: T-Account for Hypothetical Bank

Assets	Liabilities plus Equity
Loans: \$100	Deposits: \$90
Securities: \$10	Borrowings: \$0
Cash Reserves: \$10	Equity \$30

In comparing Tables 30.6 with 30.4, we see that the size of the initial balance sheet (by “size” we simply mean the total value of assets) is the same, but the bank is funding its activities less with liabilities and more with equity. If \$25 in loans go into default, the bank can stomach this loss and still have positive equity, as we can see below:

Table 30.7: T-Account for Hypothetical Bank

Assets	Liabilities plus Equity
Loans: \$75	Deposits: \$90
Securities: \$10	Borrowings: \$0
Cash Reserves: \$10	Equity \$5

We can see that holding more equity provides the bank with more of a “cushion” to absorb losses, and therefore makes it less likely that the bank will become insolvent. Why then would banks not choose to finance themselves mostly with equity in the first place? This relates back to the discussion above in Section 30.2. While holding more equity reduces the probability of bank failure, for the purposes of maximizing returns on equity a bank is incentivized to hold less equity. To see this clearly take both Table 30.4 and 30.6 to describe hypothetical initial balance sheets for a bank. Suppose that if no loans go into default, loans earn interest each period of 10 percent, while securities earn 5 percent and cash reserves earn nothing. Deposits cost 5 percent. In the first example, with initial equity of \$20, absent failure the bank would earn profit of $0.1 \times 100 + 0.05 \times 10 - 0.05 \times 100 = 5.5$, for a return on equity of $\frac{5.5}{20} = 0.2750$. In the second example, with initial equity of \$30, absent failure the bank would earn profit of $0.1 \times 100 + 0.05 \times 10 - 0.05 \times 90 = 6$, but the return on equity would be lower at $\frac{6}{30} = 0.2$.

Because having a higher leverage ratio amplifies returns on equity for a given return on assets, a bank has an incentive to “lever up” by attracting more liabilities to finance its assets. At the same time, having a lower leverage ratio reduces the likelihood of insolvency. Individual banks (and their equity investors) stand to reap all the possible gains from “levering up” so as to maximize return on equity, while because of limited liability they do not fully bear the costs of insolvency and failure. If a bank fails, some depositors (and other creditors) may lose a substantial amount of their funds, whereas the bank’s downside is limited to the initial

equity investment. For this reason, there is a misalignment between private incentives of banks and their equity investors (the incentive to lever up to maximize returns) and what society at large would prefer, which would be to not have exorbitantly high leverage ratios so as to limit the likelihood of insolvency.

Because of this misalignment of incentives, banks are highly regulated, and one of the main forms of regulation is that banks are required to maintain certain capital ratios. The main objectives in these kinds of regulation are to provide a bigger cushion to reduce the likelihood of insolvency and to force the bank to internalize some of the potential risks in its investment decisions. The more capital a bank finances itself with, the more it stands to lose (rather than its creditors) should its investments underperform. The [Basel Accords](#) are an internationally agreed upon set of guidelines for bank regulations, some of the most important of which include recommendations for required capital ratios. In addition, because of the misalignment of private and public incentives, banks are restricted in the kinds of assets in which they can invest. Traditional commercial banks are restricted to making conventional personal and business loans and holding government securities. They are prohibited, for example, from investing in the stock market, which typically has higher returns but is substantially riskier than making loans or holding government debt securities.

30.3.2 Liquidity Risk

In addition to credit risk, banks also face what is known as liquidity risk. Liquidity risk refers to the possibility that the bank’s liabilities may dry up, forcing the bank to come up with a significant amount of cash. The classic example of liquidity risk is an unexpectedly large deposit withdrawal, which reduces a bank’s liabilities and must be met with cash. More generally, liquidity risk could refer to any other sources of liabilities drying up. For example, if a bank is funding itself by borrowing from other banks, if those loans are not “rolled over” (continued) it is equivalent to a withdrawal of deposits.

We will again study liquidity risk through an example. Suppose that a bank’s initial balance sheet is as above, repeated here:

Table 30.8: T-Account for Hypothetical Bank

Assets	Liabilities plus Equity
Loans: \$100	Deposits: \$100
Securities: \$10	Borrowings: \$0
Cash Reserves: \$10	Equity \$20

In [Table 30.8](#), the bank only has \$10 in cash on hand. It can therefore only accommodate

a withdrawal of \$10. If the bank faces a withdrawal of more than \$10, it would have to sell some of its loans or securities in order to raise cash (alternatively, it could raise more equity or borrow more from other sources, but we will ignore these possibilities in the analysis to be carried out below). Since government securities are widely traded, we will assume that a bank can quickly sell securities dollar-for-dollar – that is, if the bank needs to raise \$1 in cash, it can sell \$1 in securities. In contrast, we will assume that loans are less liquid, in the precise sense that they can only be sold quickly less than dollar-for-dollar. The reason for this is that other parties who might be interested in purchasing a loan are less well-informed about the credit risks associated with a loan. Indeed, this is an adverse selection problem at work. There are loans with good credit risks and loans with bad credit risks. A third party does not know which kind of credit risk it is facing when it purchases an already issued loan, and will therefore likely only purchase a high quality loan for less than it is worth.

As an example, let us suppose that loans can only be sold quickly for \$0.5 on the dollar. Suppose that the bank faces a withdrawal of \$20. This reduces deposits from \$100 to \$80 and must be met with a reduction on the asset side of the balance sheet. Because the bank has \$10 in cash and can sell securities to raise another \$10, it can raise the cash to meet this withdrawal. Ignoring the regulatory required reserve ratio, the bank’s new balance sheet would be:

Table 30.9: T-Account for Hypothetical Bank

Assets	Liabilities plus Equity
Loans: \$100	Deposits: \$80
Securities: \$0	Borrowings: \$0
Cash Reserves: \$0	Equity \$20

Now, starting from Table 30.9, suppose that the bank faces an additional withdrawal of \$30. To raise \$30 in cash, the bank will be forced to sell \$60 in loans. This results in a \$30 loss which wipes out the bank’s equity and leaves it insolvent:

Table 30.10: T-Account for Hypothetical Bank

Assets	Liabilities plus Equity
Loans: \$40	Deposits: \$50
Securities: \$0	Borrowings: \$0
Cash Reserves: \$0	Equity -\$10

In the situation described above, even though the bank began as fundamentally solvent (in the sense that its assets were worth more than its liabilities), being forced to raise liquidity

through asset sales drives the bank into insolvency. Like insolvency arising from credit risk, this can be costly to those other than the equity investors in the bank because depositors and other creditors may lose some or all of their funds as a result of the bank failure.

Suppose that instead of starting in the situation as described in Table 30.8, the bank begins with a higher fraction of its assets being liquid. In particular, suppose that the initial balance sheet is:

Table 30.11: T-Account for Hypothetical Bank

Assets	Liabilities plus Equity
Loans: \$50	Deposits: \$100
Securities: \$30	Borrowings: \$0
Cash Reserves: \$20	Equity \$20

With \$50 in liquid assets (securities and cash reserves), the bank can meet a withdrawal of up to \$50 without having to sell any loans. Its liquidity cushion therefore provides it more leeway to withstand unexpectedly high withdrawals without having to sell illiquid assets for a loss.

In a way similar to how having a high capital ratio (equivalently a low leverage ratio) helps make a bank more resistant to credit risk, having a high liquidity ratio makes a bank more resilient to liquidity risk. Why, then, would banks not want to have high liquidity ratios? In general, the more liquid an asset is, the lowers its expected returns. Suppose, as in the example above, that loans earn 10 percent per year, securities pay 5 percent per year, reserves pay nothing, and deposits cost 5 percent per year. With the original balance sheet described in Table 30.8, absent any unexpected withdrawals the bank will expect to earn profit of $0.1 \times 100 + 0.05 \times 10 - 0.05 \times 100 = 5.5$. In the initial balance sheet described in Table 30.11, where the bank holds a larger fraction of its assets in liquid form, the bank will expect to earn profit of $0.1 \times 50 + 0.05 \times 30 - 0.05 \times 100 = 1.5$, which is substantially lower. So the tradeoff faced by an individual bank is that having a higher liquidity ratio likely will lower expected returns, while at the same time reducing downside risk of liquidation losses should the bank have to raise cash in a pinch.

As with insolvency due to credit risk, the equity investors in a bank have liability limited to their equity investment in the event of a liquidation-induced insolvency, whereas the depositors and other creditors to the bank face potentially large losses from bank failure. These outsiders would prefer the bank maintain adequate liquidity, whereas the bank itself is incentivized to minimize its holdings of liquid assets. Because of these misaligned incentives, banks are typically regulated to hold sufficient liquidity. The most well-known such regulation is the requirement that banks hold reserves equal to a fraction of total deposits – the so-called

required reserve ratio. But there are other regulatory requirements that are broader than required reserves and account for the possibility of non-deposit liabilities and non-cash assets. The Basel Accords, in addition to making recommendations about capital ratios, also makes regulatory recommendations concerning bank liquidity ratios.

Bank runs, which are the subject of Chapter 32, are situations in which liabilities dry up and banks are forced to raise cash. The classic example here is a “run” on deposits where there are larger than expected withdrawals, but “wholesale” runs can also occur wherein other institutions who have extended credit to a bank refuse to “roll over” (i.e. continue) loans. In a situation in which liabilities dry up, a bank, or the banking system more generally, is forced to come up with cash. To the extent to which the bank’s assets are illiquid, a bank (or the banking system more generally) may not be able to come up with the cash. Policies for dealing with runs are discussed at the end of Chapter 32.

30.4 Modern Banking and Shadow Banking

The financial system is in a continual process of innovation. This innovation is spurred by a desire on the part of banks and their equity investors to make profit. Innovation is also, to a large degree, driven by what is sometimes called *regulatory arbitrage*. Regulators (such as central banks) impose restrictions on the activities of banks. These restrictions often make sense in isolation – for example, requiring banks to maintain certain capital or liquidity ratios ought to reduce the likelihood of banks becoming insolvent. But these restrictions can also have undesirable effects in that they incentivize financial innovation to avoid the regulation.

The banking system in the United States and other developed countries has undergone a large transformation in the last several decades. Up until thirty years ago, banking in the US worked pretty much as described in this chapter. Banks primarily funded themselves with deposits. Banks made loans to business and individuals and made a profit by earning more on their loans than they paid for their liabilities. Banks held loans on their balance sheets until maturity.

Much of this has changed in recent years, rendering much of what we have described above as obsolete as a description of the actual reality of modern banking. We go to the trouble of introducing these concepts in a familiar, if outdated, setting because the basic principles apply to any institution engaging in financial intermediation. Financial intermediaries borrow short and lend long. They earn profit by earning more on their assets than they pay on their liabilities. Because of limited liability, they have an incentive to have high leverage and hold little liquidity. With all the changes in modern banking, these basic principles remain. What is different are the kinds of institutions engaging in financial intermediation and the roles

that they play. [Gorton \(2012\)](#) and [Gorton \(2015\)](#) provide good, book-length treatments on the history of banking and the changes it has undergone in the last decades.

Traditionally, entry into the banking industry was limited due to chartering requirements and there were ceilings on how much banks had to pay for their liabilities – the so-called [Regulation Q](#) did not allow banks to pay interest on demand deposits and limited interest that could be paid on savings deposits. Competition has significantly increased with banking deregulation and the old Regulation Q requirements are now gone. Banks now face stiffer competition in attracting funds because of the rise of money market mutual funds – these are funds which invest money in short term debt instruments, pay higher interest than demand deposits, and provide check-writing privileges that make them similar to demand deposits. Furthermore, large institutional investors (such as pension funds) now have demands for short term liabilities that look like demand deposits, but traditional demand deposits are not safe for the sums the large institutional investors have because there is no deposit insurance above \$250,000. In conjunction with these changes, regulatory requirements such as required capital ratios have made the traditional banking model increasingly unprofitable.

In recent years much of credit intermediation has therefore moved away from the traditional, regulated banking sector into what is called the *shadow banking system*. This is a somewhat amorphous term, and carries with it something of a negative connotation which may not be fair. Loosely speaking, a so-called shadow bank is any financial institution that engages in credit intermediation but which is not a traditional, regulated bank. Credit intermediation involves borrowing short and lending long, but the nature of the short term borrowing and lending are different than the traditional banking model of borrowing through deposits and making loans.

To an increasing extent, loans (which are usually made by traditional, regulated banks) are sold shortly after issuance to a third party (sometimes called a special purpose vehicle). Many different loans are then combined together and then packaged into a security. The resulting security looks like any kind of bond (corporate or government) in the sense that it entitles the holder of the security to periodic cash flows. The cash flows come from the individual loans packaged into the security. It is thought that by bundling up many loans together, risks are spread out. While a few individual loans may go bad, when bundling many together there is a higher degree of certainty over the promised cash flows. Many different kinds of loans are securitized into fixed income products like this – mortgage loans, credit card loans, student loans, etc. Generically such securities are referred to as *asset backed securities* (ABS). Securitized mortgages, which played an important role in the financial crisis and Great Recession (to be discussed in [Chapter 36](#)) are called *mortgage backed securities* (MBS).

Securitization has been going on for many decades and is not a particularly recent phenomenon, in spite of recent claims to such after the Great Recession. What has driven the move into securitization? It has primarily been driven by three factors. One factor has been the increasing demand for so-called safe assets – assets which are highly liquid and offer some relatively safe return. Much of this has been driven by the rise of large institutional investors (think pension funds and money market mutual funds), as well as foreign institutions and individuals. These large institutional investors have a desire for something that looks like a demand deposit and pays interest. For example, suppose that a large institutional investor (call it Vanguard) has \$100 million in cash. At some point it may want to use this \$100 million to purchase stocks or bonds, but not at the present. The large institutional investor would like to earn some interest while sitting on this sum, while at the same time being able to quickly use this money to purchase another asset should it find a promising deal. A traditional checking account is not a good idea – in the event a bank fails, depositors could lose their money. Deposit insurance limits losses to deposits totaling no more than \$250,000. For most individuals, this means that money in a checking account is essentially 100 percent safe. But there is no deposit insurance for sums like \$100 million. Government bonds (e.g. US Treasury Bills, Notes, and Bonds) have traditionally been the safe asset where large sums could be stored for short periods of time. But there are not enough government bonds to satisfy the demands of large institutional investors. Securitized loan products, such as MBS, have arisen to meet the need for safe assets. Through what are called *repurchase agreements*, large institutional investors can “deposit” money with a financial institution, and in the process receive MBS (or similar securitized loan products) as collateral. Should the financial institution fail, the large institutional investor gets to keep the MBS. If not, the large institutional investor simply earns interest. The MBS make the “deposit” safe. We will discuss the specifics of repurchase agreements (also called “repo” for short) in more detail below. The demand for safe assets to serve as collateral has to a large degree driven the move into securitization.

The second factor driving the move into securitization is regulatory arbitrage. Traditional banks face regulatory capital ratios, and higher capital ratios, other things being equal, reduce a bank’s return on equity. Attracting funds through liabilities (e.g. deposits) and using these funds to make loans reduces the capital ratio (the ratio of equity to assets). To get around this requirement, banks can alternatively make loans and then quickly sell them. This gets the loan “off the books” and has no effect on the capital ratio of the individual bank. The bank simply earns a processing fee for originating the loan. Another institution outside of the regulatory structure (i.e. a shadow bank) is in effect funding the loan by purchasing it from the originator, and the shadow bank is funding itself through liabilities like short term

repurchase agreements. But the shadow bank operating outside the regulatory system is not subject to the capital requirements of traditional banks. Securitization is a sensible way to get around these restrictions.

A third factor driving securitization has been the government. In the United States, [Fannie Mae](#) and [Freddie Mac](#) play an important role in the housing market. These are both government sponsored enterprises (GSE), but are publicly traded corporations. These institutions raise money in debt markets by selling bonds and use the proceeds to purchase mortgages from originators. The mortgages are then bundled into securitized MBS and sold to private investors. In this sense, their business model is not fundamentally different from banking as described above – these institutions fund themselves with liabilities (bonds as opposed to deposits) and invest in already-issued loans (rather than making the loans themselves). The implicit connection to the US government allows these institutions to borrow money at very favorable rates, making their business model profitable. The objective of these organizations is to promote affordable housing, which has been a stated objective of the US government for some time. The idea is that by creating an organization to buy up loans, this would incentivize originators to make more loans at better rates, thereby making housing more affordable to individuals.

Figure 30.2 shows how the traditional banking system works.² It is not conveying a fundamentally different message than Figure 30.1. The traditional banking system funds itself by borrowing from households, chiefly in the form of deposits – this is the arrow on the far right of the figure. The traditional banking system uses these funds to make loans to households (e.g. mortgages) and businesses (this is the arrow on the left).

Figure 30.2: Traditional Banking System



The shadow banking system is more complicated in that there are extra layers. Fundamentally, the process of intermediation as displayed in Figure 30.1 is the same, but there are extra players. How the shadow banking system works is shown in Figure 30.3. Traditional

²The analysis in this section closely follows [Gorton \(2010a\)](#).

banks make loans to consumers and businesses.³ But traditional banks increasingly do not fund themselves with deposits, and they increasingly do not keep loans on their balance sheets. Rather, these loans are sold to the shadow banking system. A left pointing arrow shows funds coming from the shadow banking system to the traditional banking system and a right arrow shows loans going from the traditional banking system to the shadow banking system. In a sense, even though shadow banking entities are not making loans themselves, they are funding the loans. Shadow banks are themselves funded by large institutional investors. We can see this with the upward pointing arrow in the figure running from institutional investors to shadow banks. The short term funding here often takes the form of repurchase agreements, which are made safe by the collateral of the asset backed securities / mortgage backed securities provided by the shadow banking system (the down pointing arrow). Institutional investors are in turn funded indirectly by households (the ultimate savers in the economy) through money market mutual funds, retirement accounts, and the like.

Figure 30.3: Shadow Banking System

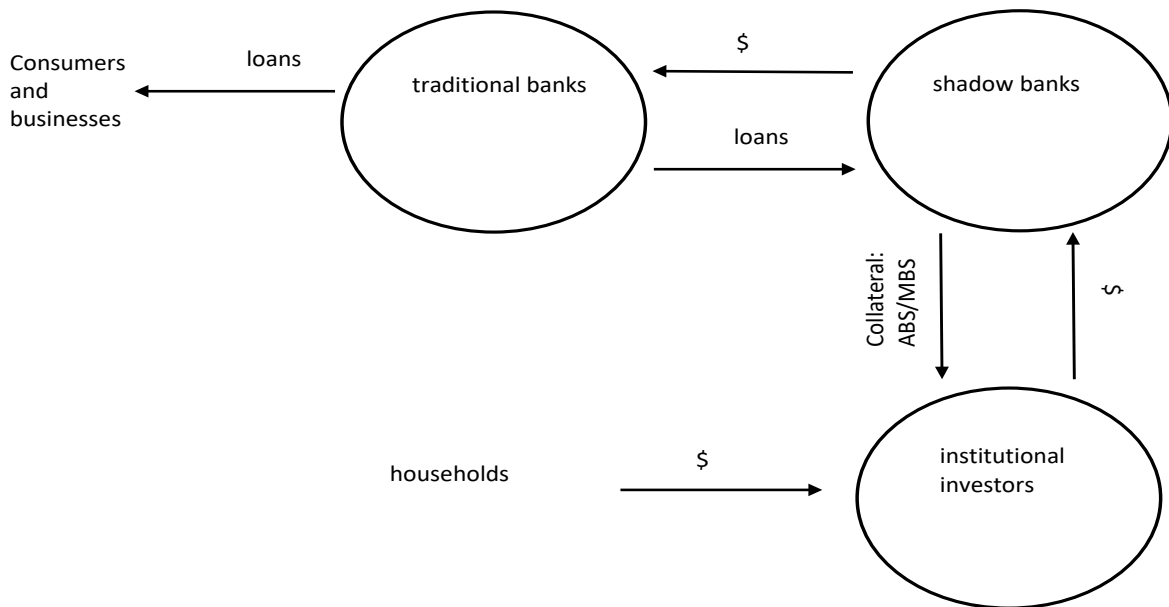

We have mentioned repurchase agreements several times above. What exactly is a repurchase agreement? In a repurchase agreement, a lender lends money to a borrower, usually overnight. The lender receives collateral, often in the form of asset backed securities, and agrees to sell those securities back to the borrower at a pre-specified price. The difference between the price at which the securities will be sold back and the initial loan amounts to interest and is called the repo rate. It is helpful to see this through an example drawn from

³To be more precise, traditional banks often fund non-bank lenders, but this detail is not particularly important.

Gorton (2010a). Suppose that a large institutional investor, call it Fidelity, has \$500 million and it wants to earn interest but does not want the funds tied up for a long time. It can loan \$500 million to a shadow bank, call it Bear Sterns, in a repurchase agreement. Bear Sterns posts \$500 million in MBS as collateral for the loan, and agrees to pay Fidelity, say, \$501 million back after one day. This amounts to an overnight interest rate (repo rate) of 0.002 (i.e. 1/500). What makes this transaction safe is the MBS serving as collateral – if Bear fails to pay Fidelity back the \$501 million, Fidelity gets to keep the collateral. Suppose that the MBS serving as collateral earn a net (overnight) return of 0.005 in expectation. Effectively, what Bear has done is to borrow funds at an interest rate of 0.2 percent (the repo rate) and earn 0.5 percent (the return on the MBS) – i.e. it is earning more on its assets than on its liabilities. This is how banking has worked throughout history, even though in this example Bear Sterns is not a bank in the sense that it is not funding itself through deposits and is not making loans to households and business directly. Repos can often be rolled in the sense that a new repo agreement can be entered into when a given repo expires. Effectively, Fidelity can keep its \$500 million lent to Bear Sterns or it can pull out.

Although there are some technical details going on in the background, we can think of the scenario described above in a way similar to how we described traditional banking. The large institutional investor (Fidelity in this example) plays the role of the depositor – the repo in which it invests is essentially like a deposit. Bear is playing the role of the bank, although it is not actually making loans, just holding securitized portfolios of loans. We can think about a hypothetical balance sheet for Bear Sterns as taking the following form:

Table 30.12: T-Account for Hypothetical Shadow Bank

Assets	Liabilities plus Equity
MBS \$500	Repo: \$500
Cash: \$100	Equity \$100

In Table 30.12, the shadow bank is funding itself with Repo and using that to purchase MBS. Comparing this to Table 30.2, Repo is playing the role of deposits, and MBS is playing the role of loans. In this hypothetical example, the shadow bank has \$100 million in cash assets and \$100 million in equity.

As noted above, Repo transactions can be rolled in the sense of continued or not. An important aspect of Repo transactions is the haircut. A Repo haircut refers to the percentage difference between the overnight loan and the value of the collateral. If a large institutional investor loans \$500 million in exchange for \$500 million in collateral, then the haircut is 0 percent. If, in contrast, the investor loans only \$400 million in exchange for \$500 million in collateral, then we say that there is a 20 percent haircut – with the haircut defined as the

difference between the collateral and the loan divided by the value of the collateral. A lender might demand a haircut because he (i) is worried about the solvency of the borrower and/or (ii) is concerned about the value of the collateral.

Suppose that on a particular day, say Monday, a shadow bank has a balance sheet like that depicted in Figure 30.12. Ignore interest for the purposes of the example which is to follow. Call the shadow bank Bear Sterns and the institutional investor Fidelity. On Tuesday Fidelity wants to roll the loan, but demands a 20 percent haircut. This means that it will only “deposit” \$400 million in exchange for \$500 million in collateral. When Monday’s Repo comes due, Bear has to pay Fidelity \$500 million, and then Fidelity turns around and gives Bear \$400 million back. This effectively amounts to a “withdrawal” of \$100 million from Bear. Its balance sheet on Tuesday will be:

Table 30.13: T-Account for Hypothetical Shadow Bank

Assets	Liabilities plus Equity
MBS \$500	Repo: \$400
Cash: \$0	Equity \$100

As we can see in Table 30.13, Bear remains solvent but has lost its \$100 cash to deal with the haircut and the repo only being partially rolled over. Although the terminology is slightly different, the situation depicted going from Tables 30.12 to 30.13 is essentially *exactly* like the liquidity risk situation we described when discussing traditional banking in Section 30.3.2. An increase in Repo haircuts, or more generally a failure for short term funding to be rolled over, creates a liquidity problem for the shadow bank which is financing itself with this short term funding. This liquidity crisis may require the shadow bank to sell other assets to come up with the cash. With many institutions simultaneously trying to do the same thing, the prices of these assets could become depressed, leading these institutions into insolvency. This is exactly analogous to loans being sold at a discount discussed above. We will return to repos, haircuts, and rollover problems when discussing the role of shadow banking in Chapter 36.

30.5 Summary

- The primary function of the financial system is to allocate resources from savers to investors.
- There are two reasons why savers do not lend directly to investors. The first is that savers have a preference for liquid assets, but investors typically invest in illiquid

projects. Financial institutions can engage in liquidity transformation which permits savers access to liquid assets while at the same time allows investors to invest in illiquid projects.

- Asymmetric information refers to any situation where the parties are not equally well-informed about one another. Adverse selection and moral hazard are two prominent types of adverse selection. Either of them can cause a market to break down.
- Like any other type of institution, a bank's balance sheet is composed of assets and liabilities with equity being defined as the difference between them.
- The typical assets for a bank include loans, financial securities, and cash reserves. The typical liability for a bank is demand deposits.
- Credit risk refers to the possibility that assets a bank holds on its balance sheet may underperform. If the bank does not have much equity to begin with, the reduction in asset value can make the bank insolvent. Banks can hedge against this risk by holding higher capital ratios.
- Liquidity risk refers to the possibility that the bank's liabilities may dry up, forcing the bank to come up with a significant amount of cash. If the bank does not hold sufficient liquid assets to match the reduction in liabilities, the bank will have to sell its less liquid assets, most likely at a discount. Banks can hedge against this risk by holding higher liquidity ratios.
- A shadow bank is any financial institution that engages in financial intermediation, but which is not a traditional, regulated bank. Over the last few decades, shadow banks have performed more of the economy's financial intermediation.

Questions for Review

1. Explain how financial institutions resolve the problem of adverse selection.
2. Why might a bank find it optimal to hold liquid assets despite the fact that they tend to earn a lower return than less liquid assets?
3. Explain why limited liability gives a financial institution an incentive to hold low capital ratios. What specific policy is designed to correct this?
4. True or false: If a financial institution has negative equity, then it is insolvent. Justify your response.
5. Compare and contrast shadow banks from more traditional banks.

Chapter 31

The Money Creation Process

In Chapters 14 and 20, as well as throughout Part IV, we assume that the central bank can perfectly control the supply of money. This is in actuality not literally true. Money is anything which serves as a medium of exchange, a store of value, and a unit of account. Currency supplied by the central bank (or Treasury) is one form of money, but more important forms of money are privately created by the banking system. Broadly speaking, debt claims issued by private banks have long been an important source of money in the sense that this bank debt is used in transactions and as a store of value across time. The most obvious form of bank debt with which we are all familiar is the demand deposit. A demand deposit is bank debt in the sense that it is a piece of paper requiring the bank to produce currency on demand, but it is also a medium of exchange in the sense that checks can be written against these deposits to conduct transactions. Other forms of bank debt have been used as money in the past, such as [bank notes](#) before the advent of nationally chartered currencies from central banks. More recently, things like [repurchase agreements](#) also play the role of bank debt that can be used in transactions.

In reality, the actual money supply in the economy is *jointly* determined by the actions of a central bank in conjunction with banks and households. We will show that a central bank can influence the money supply by adjusting the monetary base, and that the actual money supply is a multiple of this base. To the extent to which this multiple – what we will call the money multiplier – is stable, it is not a bad assumption to think of a central bank directly controlling the money supply. But in unusual times and circumstances – such as the Great Depression or Great Recession in the US – the relationship between the monetary base and the money supply often breaks down.

31.1 Some Definitions and Algebra

In this section we introduce some terms and play around with some algebra. Then we will proceed to work with T-Accounts to discuss the basic process by which a central bank can influence the money supply. We will define the money supply using the M1 definition as currency in circulation plus demand deposits. The notation we will use is CU for currency

and DP for demand deposits. We will think about things statically (i.e. within period) and so need not put time subscripts on variables. Using the $M1$ definition, the money supply, M , is:

$$M = CU + DP \quad (31.1)$$

A central bank can directly affect neither CU nor DP in (31.1). One would be tempted to think that a central bank could influence CU by simply printing more currency, but recall that CU measures currency *in circulation*. If the central bank creates CU which is then deposited into a bank, it becomes a demand deposit. Furthermore, as we will expound upon further, if deposited in a bank then that bank can create even more demand deposits through the creation of loans. But a central bank cannot compel commercial banks to create more or less deposits, and it cannot compel households to deposit their currency into a bank. Because of this, a central bank can only *indirectly* control the money supply.

The monetary base is defined as the sum of currency in circulation plus *reserves*. Reserves include currency held in bank vaults as well as reserve accounts commercial banks hold with the central bank. It is sometimes said that the monetary base constitutes the monetary liabilities of a central bank. Currency and reserves are liabilities for the central bank in the sense that the central bank has to pay currency in exchange for reserves (or currency in exchange for currency).¹ Reserve accounts with a central bank are essentially like demand deposits for banks – if a bank keeps \$100 million in its reserve account with the central bank, it can “withdraw” this and request currency, which the central bank is obligated to meet. But since the central bank can create currency, this really is not much of a liability for the central bank, so we will stick with “monetary base” instead of “monetary liabilities.”

Formally, the monetary base is:

$$MB = CU + RE \quad (31.2)$$

In (31.2), CU is again currency in circulation and RE is bank reserves. To see the relationship between MB and M , let us play around with some algebra. Multiply and divide

¹In a world with commodity-based money these monetary liabilities are in fact genuine liabilities. In a commodity-based system, currency and reserves are redeemable with the central bank in exchange for the backing commodity (e.g. gold). So, for example, if one dollar is backed by one ounce of gold, then presenting the central bank with \$100 in currency or reserves obliges the central bank to hand over 100 ounces of gold. Hence, the currency and reserves issued by the central bank represent a legitimate liability in the sense that it requires the central bank to present gold (or some other commodity) on demand. In a world based on fiat currency, as characterizes most all of the developed world today, currency and reserves are not backed by anything tangible, and hence presenting the central bank with \$100 in reserves entitles the holder to nothing more than \$100 in currency, which the central bank can freely create. In this sense, it is a bit odd to refer to currency and reserves as liabilities of a central bank, but this is the common and continuing terminology.

the right hand side of (31.2) by DP and simplify:

$$MB = DP \left(\frac{CU}{DP} + \frac{RE}{DP} \right) \quad (31.3)$$

Define $c = \frac{CU}{DP}$ as the cash-deposit ratio. This is the amount of currency held in circulation for every dollar in deposits. $\frac{RE}{DP}$ is the reserve-deposit ratio. As we saw in Chapter 30, banks are required by law to maintain a minimum reserve balance based on total deposits outstanding. Banks may choose to hold more reserves than is required (either as cash in the vault or on account with a central bank, with the primary motivation that holding more reserves means that the bank can handle larger withdrawal demands). Define $rr = \frac{RR}{DP}$ as the required reserve ratio that is set by the central bank (with RR denoting required reserves). Define $er = \frac{ER}{DP}$ as the excess reserve ratio, where ER measures excess reserves. er measures reserve balances as a fraction of deposits above and beyond what is required by the central bank. Then $RE = RR + ER$, and hence $\frac{RE}{D} = rr + er$. Hence, we can write (31.3) as:

$$MB = DP (c + rr + er) \quad (31.4)$$

Now, multiply and divide both sides of (31.1) by DP as well. After factoring out a DP and using our notation of $c = \frac{CU}{DP}$, this can be written:

$$M = DP (1 + c) \quad (31.5)$$

Combining (31.5) with (31.4) so as to eliminate the DP term yields:

$$M = \frac{1 + c}{c + rr + er} MB \quad (31.6)$$

(31.6) shows that there exists a relationship between the monetary base and the money supply. We will define mm as the number multiplying the monetary base and will refer to it as the money multiplier. We may then write:

$$mm = \frac{1 + c}{c + rr + er} \quad (31.7)$$

$$M = mm \times MB \quad (31.8)$$

We will think about a central bank as being able to determine MB . The central bank is a monopoly supplier of base money – it can create currency if it wants or credit bank reserve accounts (or debit these accounts) through what are called open market operations (which are discussed below). The central bank can effectively control MB even if it has imperfect control over the components of the base – for example, if the central bank prints

more currency, it cannot be sure that this currency ends up as currency in circulation, CU , or gets deposited into the banking system and becomes reserves, RE , but it can be sure that printing more currency (or creating more reserves) will increase the base by the same amount. In contrast, the central bank *cannot* set the money multiplier, mm . It can set a component of this multiplier, the required reserve ratio, rr , but it cannot control the currency and excess reserve ratios, c and er . While the central bank can set MB and can influence mm , it cannot directly control two components of mm , and therefore can only indirectly control M .

Figure 31.1 plots the M1 money multiplier for the US since 1984 (measured on the left axis). The money multiplier started at about 3 and declined steadily to lower than 2 before the recent Great Recession. Then it declined sharply during the Great Recession and has been below 1 ever since. We also plot the components of the money multiplier – c , rr , and er . These are measured on the right axis. The currency holding ratio started around 0.4 and increased steadily to more than 1 prior to the Great Recession. In contrast, from 1984-2007 the required reserve ratio is constant (at about 0.05) and excess reserves are essentially zero. Hence, the rise in the currency holding ratio accounts for the observed decline in the M1 money multiplier prior to the Great Recession. This has not so much been from an increase in desired currency holdings (though there is some of that, particularly currency held abroad, often for illicit purposes), but more because of a reduction in deposits resulting from the movement of funds out of standard checking accounts and into money market mutual funds (which are counted in M2, but not in M1) and other investment accounts. The precipitous fall in the money multiplier in 2008, in contrast, is almost solely attributable to the massive increase in excess reserve holdings by banks.

Figure 31.1: The M1 Money Multiplier and Its Components

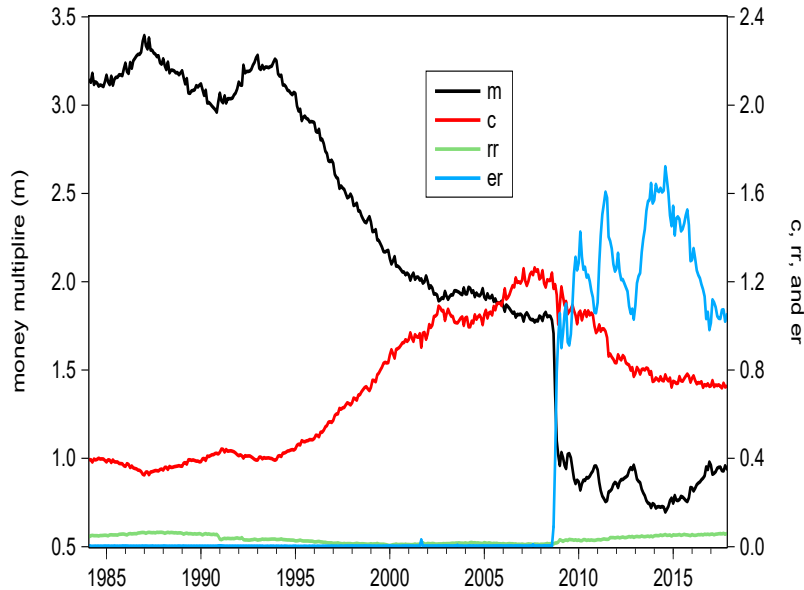

31.2 Open Market Operations and the Simple Deposit Multiplier with T-Accounts

Why is the money supply a multiple of the monetary base? To the extent to which the money multiplier is stable, how do changes in the monetary base affect the money supply? While the algebra in the previous section is reasonably straightforward, it does not offer particularly insightful intuition. To build intuition, we will illustrate these concepts using T-accounts as developed in Chapter 30 to think intuitively about the money creation process.

Suppose that there are many households in the economy and many banks. The required reserve ratio is $rr = 0.1$. No households hold cash, so $c = 0$, and no banks hold excess reserves, so $er = 0$. On the asset side of the balance sheet, banks make loans to businesses and individuals and hold government securities. Suppose that the balance sheet of the banking system *as a whole* is as follows:

Table 31.1: Balance Sheet for Banking System as a Whole

Assets	Liabilities plus Equity
Loans: \$1 billion	Deposits: \$1 billion
Securities: \$100 million	
Reserves \$100 million	Equity \$200 million

The banking system has \$1 billion in deposits, has issued \$1 billion in loans, holds \$100 million in securities, and holds \$100 million in reserves (10 percent of total deposits). Equity

in this example is \$200 million (the difference between the value of assets and the value of liabilities). Because the household holds no cash, we need not worry about the balance sheet of the non-banking public.

Now let us think about the central bank's balance sheet. Its liabilities are reserves (there is no currency in circulation), and it also holds government securities as assets. Assume that the central bank holds \$300 million in government securities, so that its equity is \$200 million. The central bank's balance sheet is:

Table 31.2: Balance Sheet for Central Bank

Assets	Liabilities plus Equity
Securities: \$300 million	Reserves: \$100 million
	Equity \$200 million

The monetary base in this example is \$100 million and the money supply is \$1 billion, equal to total demand deposits. The money multiplier is the ratio of these two, or 10, which one also gets from (31.7).

Central banks primarily affect the money supply through *open market operations*, which involve the buying or selling of government securities. In an open market purchase, a central bank buys securities from the banking system. In doing so, the central bank credits bank reserve balances for the amount of securities purchased. This then gives the banking system excess reserves, which allows the system to issue more loans. In the process of issuing loans, the banking system creates deposits, which, as we will see, can lead to a multiple expansion of the money supply. An open market sale works in the opposite direction.

Suppose that the banking system as a whole is composed of 100 different banks, all of whom have assets and liabilities equal to 1/100 of the system as a whole. This means that the balance sheet of a particular bank is:

Table 31.3: Balance Sheet for a Particular Bank

Assets	Liabilities plus Equity
Loans: \$10 million	Deposits: \$10 million
Securities: \$1 million	
Reserves \$1 million	Equity \$2 million

We will focus on an example concerning an open market purchase. Suppose that the central bank goes to a particular bank, call it Bank A, and purchases \$1 million of government securities. The balance sheet for Bank A will then be (changes in blue):

Table 31.4: Open Market Purchase from Bank A

Assets	Liabilities plus Equity
Loans: \$10 million	Deposits: \$10 million
Securities: \$0 million (-\$1 million)	
Reserves \$2 million (+\$1 million)	Equity \$2 million

The central bank pays for the securities by creating reserve balances. So the central bank's balance sheet becomes:

Table 31.5: Balance Sheet for Central Bank After Open Market Purchase

Assets	Liabilities plus Equity
Securities: \$301 million (+\$1 million)	Reserves: \$101 million (+\$1 million)
	Equity \$200 million

The transaction affects the equity of neither the central bank nor the bank selling the securities. The central bank's balance sheet expands by the amount of the purchase (i.e. both assets and liabilities increase), while only the composition of assets held by Bank A change, not the total size of assets. In particular, the bank now holds \$2 million in reserves, yet it is only required to hold \$1 million. We are assuming that the bank does not want to hold excess reserves. What can it do? It can issue more loans, and in the process create more deposits. Here we are assuming that there is a market for more loans, which may or may not characterize reality. Suppose that Bank A makes an additional loan for \$1 million (the amount of its excess reserves). In the process of doing this, it simply creates a deposit for the amount of the loan for the person or business taking the loan. Its new balance sheet will look like:

Table 31.6: Bank A Makes a Loan

Assets	Liabilities plus Equity
Loans: \$11 million (+\$1 million)	Deposits: \$11 million (+\$1 million)
Securities: \$0 million	
Reserves \$2 million	Equity \$2 million

The bank is now holding $\frac{2}{11} = 0.1818$ of total deposits in reserves, which is above the requirement. If Bank A were confident that the loan it issued would stay as a deposit in its bank, it could confidently make even more loans. But that's not likely – borrowers get loans to purchase things. Suppose that the borrower receiving the loan (on whom we need not focus) purchases something (e.g. a house). When the borrower does this, he or she writes

a check for the amount \$1 million. Assume that the check is deposited into Bank B, who initially looks exactly like Bank A initially looked. Bank A's balance sheet becomes:

Table 31.7: Bank A's Loan is Deposited Elsewhere

Assets	Liabilities plus Equity
Loans: \$11 million	Deposits: \$10 million (-\$1 million)
Securities: \$0 million	
Reserves \$1 million (-\$1 million)	Equity \$2 million

Bank A is left with the same amount of deposits and reserves as before the open market purchase, but now has more loans on its balance sheet. The \$1 million gets deposited into Bank B, whose balance sheet becomes:

Table 31.8: Bank B Gets a Deposit

Assets	Liabilities plus Equity
Loans: \$10 million	Deposits: \$11 million (+\$1 million)
Securities: \$1 million	
Reserves \$2 million (+\$1 million)	Equity \$2 million

Bank B now has an extra \$1 million in deposits and \$1 million in reserves. Bank B now has excess reserves of \$0.9 million – it is required, with deposits of \$11 million, to hold \$1.1 million in reserves, but it has \$2 million in reserves. Like Bank A before it, assume that Bank B makes a loan for the full amount of its excess reserves. Its new balance sheet will be:

Table 31.9: Bank B Makes a Loan

Assets	Liabilities plus Equity
Loans: \$10.9 million (+\$0.9 million)	Deposits: \$11.9 million (+\$0.9 million)
Securities: \$1 million	
Reserves \$2 million	Equity \$2 million

This additional loan totaling \$0.9 million will be used to purchase something (e.g. a boat) and will be deposited elsewhere. When this deposit happens, Bank B's balance sheet becomes:

Table 31.10: Bank B's Loan Gets Deposited Elsewhere

Assets	Liabilities plus Equity
Loans: \$10.9 million	Deposits: \$11.0 million (-\$0.9 million)
Securities: \$1 million	
Reserves \$1.1 million (-\$0.9 million)	Equity \$2 million

Bank B is now just exactly satisfying its reserve requirement, like Bank A before it. Differently than Bank A, Bank B's balance sheet has expanded in size – it now holds an addition \$1 million in assets and \$1 million in liabilities, with its overall equity unchanged.

Assume that the \$0.9 withdrawn from Bank B gets deposited in another bank, call it Bank C. Bank C's balance sheet becomes:

Table 31.11: Bank C Gets a Deposit

Assets	Liabilities plus Equity
Loans: \$10 million	Deposits: \$10.9 million (+\$0.9 million)
Securities: \$1 million	Equity \$2 million
Reserves \$1.9 million (+\$0.9 million)	

Bank C is now holding excess reserves. It is only required to hold \$1.09 million in reserves, yet it holds \$1.9 million after this deposit. This means that the bank holds \$0.81 in excess reserves. Like the other banks, assume that it makes a loan for this amount, in the process creating deposits.

Table 31.12: Bank C Makes a Loan

Assets	Liabilities plus Equity
Loans: \$10.81 million (+\$0.81 million)	Deposits: \$11.71 million (+\$0.81 million)
Securities: \$1 million	Equity \$2 million
Reserves \$1.9 million	

These funds will be used to purchase something and hence the deposits will move elsewhere in the banking system, say to Bank D. Bank C's balance sheet will become:

Table 31.13: Funds are Withdrawn from Bank C

Assets	Liabilities plus Equity
Loans: \$10.81 million	Deposits: \$10.9 million (-\$0.81 million)
Securities: \$1 million	Equity \$2 million
Reserves \$1.09 million (-\$0.81 million)	

Bank C is again just satisfying its reserve requirement, though like Bank B before it, the overall size of its balance sheet has expanded as a result of it receiving more deposits. Bank D, who receives funds from the loan made by Bank C, will have a new balance sheet of:

Table 31.14: Bank D Gets a Deposit

Assets	Liabilities plus Equity
Loans: \$10 million	Deposits: \$10.81 million (+\$0.81 million)
Securities: \$1 million	
Reserves \$1.81 million (+\$0.81 million)	Equity \$2 million

Bank D is required to hold \$10.081 million in reserves, yet it holds \$1.81. This means that it has \$0.729 in excess reserves. It, too, will make a loan. In so doing it creates deposits. These funds will likely end up somewhere else in the banking system, which will in turn fuel the creation of additional loans and additional deposits.

Let us now pause and take stock of what is happening with different banks. This is detailed in Table 31.15:

Table 31.15: Deposit Creation

Bank	Δ Loans	Δ Deposits	Δ Reserves
A	1	0	0
B	0.9	1	0.1
C	0.81	0.9	0.09
D	0.729	0.81	0.081
\vdots	\vdots	\vdots	

The initial open market purchase gives Bank A \$1 million extra in reserves. This does not stay as reserves in Bank A. Rather, it allows Bank A to extend a loan in this amount. The funds from this loan are deposited in Bank B. So the only thing that changes on Bank A's balance sheet is that it has more loans and fewer government securities. Bank B receives an additional deposit of \$1 million (equal to the value of the loan issued by Bank A). It is required to hold \$0.1 million of this in additional reserves, and can lend out the rest, \$0.9 million. The funds from this loan get deposited in Bank C. It must keep 10 percent, or \$0.09 million, of the additional funds in reserves. It can lend the remaining \$0.81 million out. This creates an additional deposit of \$0.81 million for Bank D. And so on – the process continues to play out until there are no more funds to be lent out.

The pattern that is emerging is as follows:

$$\Delta D = \$1 + \$0.9 + \$0.81 + \$0.729 + \dots \quad (31.9)$$

If we were to keep going, in terms of a generic required reserve ratio, rr , we would see that mathematically this works out to:

$$\Delta D = \$1 [1 + (1 - rr) + (1 - rr)^2 + (1 - rr)^3 + \dots] \quad (31.10)$$

The initial \$1 million in additional reserves generates an additional \$1 million in deposits for Bank B. This then generates an additional $(1 - rr)$ in deposits by Bank C, and then $(1 - rr)^2$ in extra deposits for Bank D. The term inside the brackets of (31.10) is an infinite sum, which we can denote:

$$SU = 1 + (1 - rr) + (1 - rr)^2 + (1 - rr)^3 + \dots \quad (31.11)$$

Multiply both sides of (31.11) by $(1 - rr)$:

$$SU(1 - rr) = (1 - rr) + (1 - rr)^2 + (1 - rr)^3 + (1 - rr)^4 + \dots \quad (31.12)$$

Subtract (31.12) from (31.11). Since $1 - rr < 1$, $(1 - rr)^h \rightarrow 0$ as h gets big. This means that all but the first term on the right hand side cancels out, which leaves:

$$SU = \frac{1}{1 - (1 - rr)} = \frac{1}{rr} \quad (31.13)$$

But this means that the total change in deposits is:

$$\Delta D = \frac{1}{rr} \$1 \quad (31.14)$$

The total change in reserves held in the banking system is:

$$\Delta R = [rr + rr \times (1 - rr) + rr \times (1 - rr)^2 + \dots] \quad (31.15)$$

This can be written:

$$\Delta R = rr [1 + (1 - rr) + (1 - rr)^2 + \dots] \quad (31.16)$$

Which reduces to:

$$\Delta R = \frac{rr}{1 - (1 - rr)} = 1 \quad (31.17)$$

In other words, the open market purchase (which generates \$1 million in additional reserves for Bank A), doesn't stay as reserves with Bank A. Rather, these reserves get distributed to the rest of the banking system, so that the expansion of reserves for the banking system as a whole in fact equals the initial injection of reserves. The total change in deposits (equal to the change in the money supply, since we are assuming no currency holding) is a multiple

of the initial injection of reserves. This multiple is $\frac{1}{rr}$, which is what the money multiplier expression (31.7) reduces to when $c = er = 0$. A \$1 million open market purchase will support \$10 million in new deposits. The new balance sheet for the banking system as a whole after the open market operation is:

Table 31.16: Balance Sheet for Banking System as a Whole After Open Market Purchase

Assets	Liabilities plus Equity
Loans: \$1.01 billion	Deposits: \$1.01 billion
Securities: \$99 million	
Reserves \$101 million	Equity \$200 million

In this example, a \$1 million change in reserves (equal to the change in the monetary base) generates an addition \$0.01 billion in loans and a \$0.01 billion change in deposits, or \$10 million. Because banks only hold a fraction of total deposits in the form of reserves, an injection of reserves into the banking system supports a *multiple* expansion of deposits, at least in theory. Assuming no excess reserve holding and no currency holding, deposits equal $\frac{1}{rr}$ times reserves. We refer to this as the *simple deposit* multiplier.

31.3 The Money Multiplier with Cash and Excess Reserve Holdings

In the example from the previous section, while the central bank can directly influence the monetary base, it can perfectly control the money supply because the money multiplier is simply $\frac{1}{rr}$ and it gets to set rr . Let us now relax the assumptions made in the previous section that (i) households hold no cash and (ii) banks hold no excess reserves. Continue to assume that the required reserve ratio is $rr = 0.1$. But suppose that the cash-deposit ratio is $c = 0.1$ and the excess reserve ratio is $er = 0.1$. Suppose that the balance sheet of the banking system as a whole is initially:

Table 31.17: Balance Sheet for Banking System as a Whole

Assets	Liabilities plus Equity
Loans: \$820 million	Deposits: \$900 million
Securities: \$100 million	
Reserves: \$180 million	Equity \$200 million

In Table 31.17, the bank holds reserves as a fraction of deposits of 20 percent. The banking system is only required to hold \$90 million in reserves given \$900 million in deposits.

It is holding an additional \$90 million in excess reserves, so $er = 0.1$. We assume that it still holds \$100 million in government securities and has \$200 million equity. Hence, it has issued loans of \$820 million.

When there was no cash holding, we did not need to worry about the household sector because the households just held deposits. Now we do. Suppose that households and firms in the economy (as a whole, which we shall call the “Non-Bank Public”) begin with the balance sheet:

Table 31.18: Balance Sheet for Non-Bank Public

Assets	Liabilities plus Equity
Deposits: \$900 million	Loans: \$820 million
Cash: \$90 million	
Plant, Equipment, Housing: \$1 billion	Equity \$1.17 billion

The deposits on account with the banking system are an asset to the non-banking public, as is the cash in circulation. As specified above, the non-bank public holds 10 percent of deposits in the form of cash, so there is \$90 million currency in circulation. In addition, the non-banking public holds physical capital (plant, equipment, and housing) of \$1 billion. The \$820 million in loans is a liability for the non-banking public, leaving it with \$1.17 billion in equity.

Next, consider the balance sheet for the central bank, shown below in Table 31.19. The \$90 million in currency and \$180 million in reserves are liabilities for the central bank. We assume that it initially holds \$300 million in government securities, so its equity is \$30 million.

Table 31.19: Balance Sheet for Central Bank

Assets	Liabilities plus Equity
Securities: \$300 million	Currency in Circulation: \$90 million
	Reserves: \$180 million
	Equity \$30 million

Although not relevant for the analysis to follow, for completeness we also show the balance sheet of the fiscal authority which issues the government securities. For simplicity, assume that the government has no assets (this is obviously unrealistic). The \$400 million in securities (\$300 million of which are held by the central bank and \$100 million of which are held by private banks) are liabilities for the government. Hence, the government has equity of -\$400 million and is, technically, insolvent. Its balance sheet is shown below:

Table 31.20: Balance Sheet for Government

Assets	Liabilities plus Equity
	Securities: \$400 million
	Equity -\$400 million

One observes that if one adds up the equity of the government (-\$0.4 billion), the central bank (\$0.03 billion), the banking system (\$0.2 billion), and the non-bank public (\$1.17 billion), one gets total equity in the economy of \$1 billion, which is equal to the plant, equipment, and housing held by the non-bank public (i.e. the physical capital stock in the economy). It is for this reason that “equity” is often referred to as “capital” or sometimes “equity capital.” For the economy as a whole, total equity equals total capital, which we can think of as comprising *non-financial assets* like plant, equipment, and housing. Non-financial assets help produce more output. Financial assets (like loans, deposits, and securities) are not *net* assets in an aggregate sense because one person’s financial asset (like the deposits held by the non-bank public) are another’s liability (in the case of deposits, a liability of the banking sector). The difference between total assets and total liabilities in the economy just equals non-financial assets, or physical capital.

For the example laid out above, the total money supply is \$990 million – \$90 million in currency plus \$900 million deposits. The monetary base is \$270 million – \$90 in currency plus \$180 in reserves. The ratio of the money supply to the monetary base is 3.67, which is equal to the theoretical expression for the money multiplier given in (31.7) above, $\frac{1.1}{0.3} = 3.67$.

To see at an intuitive level *why* this is the money multiplier, let us suppose that the central bank does an open market operation in which it injects \$1 million of reserves into the banking system. As in the previous example, suppose that there are 100 identical banks to begin with. Suppose that bank A is one of those 100 banks, whose initial balance sheet is simply proportional to the balance sheet of the banking system as a whole:

Table 31.21: Initial Balance Sheet for Bank A

Assets	Liabilities plus Equity
Loans: \$8.2 million	Deposits: \$9 million
Securities: \$1 million	
Reserves: \$1.8 million	Equity \$2 million

The open market purchase of \$1 million in government securities changes Bank A’s balance sheet to:

Table 31.22: Open Market Purchase from Bank A

Assets	Liabilities plus Equity
Loans: \$8.2 million	Deposits: \$9 million
Securities: \$0 million (-\$1 million)	
Reserves: \$2.8 million (+\$1 million)	Equity \$2 million

The open market purchase simply alters the composition of Bank A's assets away from securities and towards reserves. The new balance sheet of the central bank is:

Table 31.23: Balance Sheet for Central Bank After Open Market Purchase

Assets	Liabilities plus Equity
Securities: \$301 million (+\$1 million)	Currency in Circulation: \$90 million
	Reserves: \$181 million (+\$1 million)
	Equity \$30 million

Immediately after the open market purchase, Bank A is holding 31.1 percent of its deposits as reserves. The bank wishes to hold 20 percent of deposits in the form of reserves (10 percent of which it is required to by law and 10 percent of which it chooses to hold). Bank A can therefore afford to make a loan of \$1 million while maintaining its desired reserve holdings. Suppose that it does so. When it makes the loan, it simply credits the recipient of the loan with deposits of equal amount to the loan. Its new balance sheet will be:

Table 31.24: Bank A Makes a Loan

Assets	Liabilities plus Equity
Loans: \$9.2 million (+\$1 million)	Deposits: \$10 million (+\$1 million)
Securities: \$0 million	
Reserves: \$2.8 million	Equity \$2 million

The loan goes to the non-bank public. Its balance sheet immediately becomes:

Table 31.25: Non-Bank Public gets a Loan

Assets	Liabilities plus Equity
Deposits: \$901 million (+\$1 million)	Loans: \$821 million (+\$1 million)
Cash: \$90 million	
Plant, Equipment, Housing: \$1 billion	Equity \$1.17 billion

The non-bank public desires to hold 10 percent of its total deposits in the form of cash. It is not doing so after getting this loan, since its deposits increase but cash holdings remain

the same. The non-bank public will want to make a withdrawal such that it is again holding 10 percent of its total deposits in cash. Let d denote the size of the withdrawal. To satisfy its desired cash holding ratio, relative to the balance sheet depicted in Table 31.25, we must have:

$$\frac{90 + d}{901 - d} = c \quad (31.18)$$

In (31.18), d is the withdrawal and c is the desired cash to deposit ratio. Solving for d in terms of c , we get:

$$d = \frac{c}{1 + c} \quad (31.19)$$

For a desired cash holding ratio of $c = 0.1$, the requisite withdrawal is evidently $d = 0.0909$. After making this withdrawal, the non-bank public's balance sheet will be:

Table 31.26: Non-Bank Public Withdraws Cash

Assets	Liabilities plus Equity
Deposits: \$900.90909 million (-\$0.0909 million)	Loans: \$821 million
Cash: \$90.090909 million (+\$0.0909 million)	Equity \$1.17 billion
Plant, Equipment, Housing: \$1 billion	

The movement in Table 31.26 gets the non-bank public back to its desired 10 percent cash holding ratio. The withdrawal of cash affects the balance sheet of Bank A, who must draw down its reserve holdings to meet the cash demand. Its new balance sheet is:

Table 31.27: Bank A Handles Cash Withdrawal

Assets	Liabilities plus Equity
Loans: \$9.2 million	Deposits: \$9.90909 million (-\$0.0909 million)
Securities: \$0 million	Equity \$2 million
Reserves: \$2.70909 million (-\$0.0909 million)	

As in the previous section, the non-bank public does not borrow money to simply sit on deposits. It does so to purchase things. Suppose that the non-bank public uses the extra \$0.90909 million left in deposits from the loan it received to conduct a transaction. This transaction is settled with Bank B, who receives \$0.90909 million. Bank A must transfer \$0.90909 million to Bank B. Bank A's balance sheet becomes:

Table 31.28: Bank A's Loan is Deposited Elsewhere

Assets	Liabilities plus Equity
Loans: \$9.2 million	Deposits: \$9.0 million (-\$0.90909 million)
Securities: \$0 million	
Reserves: \$1.8 million (-\$0.90909 million)	Equity \$2 million

Bank A is once again holding 20 percent of its total deposits in the form of reserves. Relative to where it initially found itself (Table 31.21), it has simply swapped Securities for Loans, with no change in reserves or deposits. But the extra \$1 million in loans it has issued is supporting an additional \$0.0909 in cash in circulation and \$0.90909 million in deposits. These deposits are transferred from Bank A to Bank B when the transaction takes place. Prior to the transaction, Bank B's balance sheet looks just like Table 31.21. After the transaction, its new balance sheet is:

Table 31.29: Bank B Gets a Deposit

Assets	Liabilities plus Equity
Loans: \$8.2 million	Deposits: \$9.9090 million (+\$0.90909 million)
Securities: \$1 million	
Reserves: \$2.70909 million (+\$0.90909 million)	Equity \$2 million

In Table 31.29, Bank B is holding 27.27 percent of its deposits in reserves, which is more than it desires. Given deposits of \$9.9090 million, the bank needs \$1.9818 million in reserves. It therefore has reserves of \$0.7272 million in excess of its desired reserve holdings given its new deposit level. It can therefore afford to make a loan to the non-bank public in this amount. After doing so, its new balance sheet will be:

Table 31.30: Bank B Makes a Loan

Assets	Liabilities plus Equity
Loans: \$8.9272 million (+\$0.72727 million)	Deposits: \$10.6364 million (+\$0.72727 million)
Securities: \$1 million	
Reserves: \$2.70909 million	Equity \$2 million

This new loan of \$0.72727 million is received by the non-bank public. Its balance sheet goes from Table 31.26 to:

Table 31.31: Non-Bank Public Gets a Loan

Assets	Liabilities plus Equity
Deposits: \$901.6363 million (+\$0.7272 million)	Loans: \$821.72727 million (+\$0.7272 million)
Cash: \$90.09090 million	
Plant, Equipment, Housing: \$1 billion	Equity \$1.17 billion

In Table 31.31, the non-bank public is holding less cash than it desires. As shown in (31.19), it will need to withdraw $\frac{c}{1+c}$ of this additional deposit to be meeting its desired cash holdings. For a desired cash-deposit ratio of 10 percent, this requires withdrawing \$0.0661 in cash. Its balance sheet after the withdrawal becomes:

Table 31.32: Non-Bank Public Withdraws Cash

Assets	Liabilities plus Equity
Deposits: \$901.5702 million (-\$0.0661 million)	Loans: \$821.7272 million
Cash: \$90.1570 million (+\$0.0661 million)	
Plant, Equipment, Housing: \$1 billion	Equity \$1.17 billion

This gets the household back to its desired 10 percent cash holding rate. But it is a withdrawal from Bank B, whose new balance sheet is:

Table 31.33: Bank B Handles Withdrawal

Assets	Liabilities plus Equity
Loans: \$8.9272 million	Deposits: \$10.5703 million (-\$0.0661 million)
Securities: \$1 million	
Reserves: \$2.6430 million (-\$0.0661 million)	Equity \$2 million

At this point, it is useful to step back and examine the balance sheet of the banking system as a whole. 98 banks look exactly like Table 31.21 – they have \$9 million in deposits, \$8.2 million in loans, \$1 million in securities, and \$1.8 million in reserves. Bank A has \$9 million in deposits, \$1.8 million in reserves, \$0 in securities, and \$9.2 million in loans. Bank B has \$10.5703 million in deposits, \$2.6430 million in reserves, \$1 million in securities, and \$8.9272 million in loans. The system as a whole has $98 \times 9 + 9 + 10.5703 = 901.5703$ in deposits and $98 \times 8.2 + 9.2 + 8.92727 = 821.7272$ in loans. Note that loans and deposits for the banking system equal loans and deposits for the non-bank public as a whole (once one takes into account rounding in the tables).

Bank B has issued additional loans of \$0.72727 million, of which \$0.6612 remains in deposits, the other \$0.0661 million has been withdrawn as cash. Assume that these deposits

are used to purchase some good or service and that the receiving bank is Bank C. Bank C initially looks just like all the other banks initially look. When this transaction takes place, Bank B's balance sheet will go to:

Table 31.34: Bank B's Loan is Deposited Elsewhere

Assets	Liabilities plus Equity
Loans: \$8.9272 million	Deposits: \$9.9090 million (-\$0.6612 million)
Securities: \$1 million	Equity \$2 million
Reserves: \$1.9818 million (-\$0.6612 million)	

At this point, Bank B is holding exactly 20 percent of its deposits in the form of reserves. The \$0.6612 withdrawn from Bank B gets deposited at Bank C. Its new balance sheet is:

Table 31.35: Bank C Receives Deposit

Assets	Liabilities plus Equity
Loans: \$8.2 million	Deposits: \$9.6612 million (+\$0.6612 million)
Securities: \$1 million	Equity \$2 million
Reserves: \$2.4612 million (+\$0.6612 million)	

Bank C is now holding reserves in excess of what it desires. It has received \$0.6612 million in new deposits, and only wants to hold 20 percent of this in reserves (i.e. \$0.1322 million in reserves). This means it can safely afford to lend out \$0.5289 million (i.e. \$0.6612-\$0.1322 million).

Table 31.36: Bank C Makes Loan

Assets	Liabilities plus Equity
Loans: \$8.7290 million (+\$0.5289 million)	Deposits: \$10.1902 million (+\$0.5289 million)
Securities: \$1 million	Equity \$2 million
Reserves: \$2.4612 million	

The non-bank public receives this loan. Its new balance sheet immediately after the transaction is:

Table 31.37: Non-Bank Public Gets a Loan

Assets	Liabilities plus Equity
Deposits: \$902.0991 million (+\$0.5289 million)	Loans: \$822.2561 million (+\$0.5289 million)
Cash: \$90.157 million	Equity \$1.17 billion
Plant, Equipment, Housing: \$1 billion	

Given our continued assumptions, the non-bank public wishes to hold 10 percent of its deposits in the form of cash. It will withdraw $\frac{c}{1+c} = 0.0909$ times the additional deposits it now has, which works out to \$0.0481. Its new balance sheet will be:

Table 31.38: Non-Bank Public Withdraws Cash

Assets	Liabilities plus Equity
Deposits: \$902.0510 million (-\$0.0481 million)	Loans: \$822.2561 million
Cash: \$90.2051 million (+\$0.0481 million)	Equity \$1.17 billion
Plant, Equipment, Housing: \$1 billion	

Bank C must handle this withdrawal by drawing down its reserves. Its new balance sheet is:

Table 31.39: Bank C Handles Withdrawal

Assets	Liabilities plus Equity
Loans: \$8.7290 million	Deposits: \$10.1421 million (-\$0.0481 million)
Securities: \$1 million	Equity \$2 million
Reserves: \$2.4131 million (-\$0.0481 million)	

At this point, the remaining additional deposits Bank C has made will be used in transaction and deposited elsewhere, say Bank D. This amounts of \$0.4808 in deposits. Bank C's new balance sheet after dealing with this deposit transfer will be:

Table 31.40: Deposits are Withdrawn from Bank C

Assets	Liabilities plus Equity
Loans: \$8.7184 million	Deposits: \$9.6612 million (-\$0.4808 million)
Securities: \$1 million	Equity \$2 million
Reserves: \$1.9323 million (-\$0.4808 million)	

Once again, at this point Bank C is holding exactly 20 percent of its deposits in the form of reserves, and so it is satisfying its required plus desired excess reserve holdings. These funds will be deposited in another bank, call it Bank D. Its new balance sheet will be:

Table 31.41: Bank D Receives a Deposit

Assets	Liabilities plus Equity
Loans: \$8.2 million	Deposits: \$9.4808 million (+\$0.4808 million)
Securities: \$1 million	Equity \$2 million
Reserves: \$2.2808 million (+\$0.4808 million)	

The process continues. Bank D now has reserves in excess of what it desires. It can therefore afford to make additional loans. Bank D has received an additional \$0.4808 million in deposits, and only wishes to hold \$0.0962 million of this in additional reserves. It can therefore safely make an additional loan of \$0.3846 million. When it makes the loan, it expands deposits by the same amount. After doing so, its new balance sheet will be:

Table 31.42: Bank D Makes a Loan

Assets	Liabilities plus Equity
Loans: \$8.5846 million (+\$0.3846 million)	Deposits: \$9.8654 million (+\$0.3846 million)
Securities: \$1 million	
Reserves: \$2.2808 million	Equity \$2 million

This loan is then received by the non-banking public. Its new balance sheet immediately after receiving the loan is:

Table 31.43: Non-Bank Public Gets a Loan

Assets	Liabilities plus Equity
Deposits: \$902.4356 million (+\$0.3846 million)	Loans: \$822.6407 million (+\$0.3846 million)
Cash: \$90.2051 million	
Plant, Equipment, Housing: \$1 billion	Equity \$1.17 billion

The non-banking public needs to withdraw some cash in amount of $\frac{c}{1+c}$ times its new deposit in order to restore its desired cash holding ratio. This means it needs to withdraw \$0.0350.

Table 31.44: Non-Bank Public Withdraws Cash

Assets	Liabilities plus Equity
Deposits: \$902.4006 million (-\$0.0350 million)	Loans: \$822.6407 million
Cash: \$90.2401 million (+\$0.0350 million)	
Plant, Equipment, Housing: \$1 billion	Equity \$1.17 billion

Bank D must handle this cash withdrawal by drawing down reserves. Its new balance sheet will be:

Table 31.45: Funds are Withdrawn from Bank D

Assets	Liabilities plus Equity
Loans: \$8.5846 million	Deposits: \$9.8304 million (-\$0.0350 million)
Securities: \$1 million	
Reserves: \$2.2458 million (-\$0.0350 million)	Equity \$2 million

When it issued a loan, Bank D created \$0.3846 of additional deposits, of which \$0.3496 remain in deposits. These funds will be used for a transaction with another bank (call it Bank E), which will lead Bank D's balance sheet to change to:

Table 31.46: Deposits are Withdrawn from Bank D

Assets	Liabilities plus Equity
Loans: \$8.5733 million	Deposits: \$9.4808 million (-\$0.3496 million)
Securities: \$1 million	
Reserves: \$1.8962 million (-\$0.3496 million)	Equity \$2 million

With the situation described in Table 31.46, Bank D is holding exactly 20 percent of its deposits in the form of reserves. This process will continue, with the \$0.3496 withdrawn from Bank D deposited into Bank E. At this point, it is worth stopping and noting the patterns evident, similarly to how we proceeded in the previous section.

Table 31.47 shows how the relevant balance sheet entries for each bank change subsequent to the open market purchase, as well as how cash held by the non-bank public changes. Bank A initially gets reserves in excess of what it wishes to hold of \$1 million, which allows it to make a loan of this amount. $\frac{c}{1+c} = 0.09090$ percent of this loan is withdrawn as cash held by the non-bank public and $1 - \frac{c}{1+c} = \frac{1}{1+c} = 0.90909$ percent is re-deposited into Bank B.

Table 31.47: Deposit, Loan, and Cash Changes

Bank	Δ Loans	Δ Deposits	Δ Reserves	Δ Cash in Circulation
A	1	0	0	0.0909
B	0.7272	0.90909	0.1818	0.0661
C	0.5289	0.6612	0.1322	0.0481
D	0.3846	0.4808	0.0962	0.0350
E	:	0.3496	:	:
:	:	:	:	:

Bank B can afford to make a loan equal to 80 percent (i.e. $1 - rr - er$) of its new deposits, holding the other fraction as reserves. This amounts to an additional loan of \$0.7272 and additional reserves of \$0.1818. The non-bank public wishes to hold a factor 0.09090 of this additional loan in cash, which amounts to a withdrawal of \$0.0661. The remainder, \$0.7272 - \$0.0661, or \$0.6612, is deposited with Bank C. Bank C can afford to extend an additional loan of 80 percent of this (i.e $1 - rr - er$), or an additional loan of \$0.5289. The non-bank public will withdraw $\frac{c}{1-c} \times 0.5289 = 0.0481$ of this in cash. This leaves $0.5289 - 0.0481 = 0.4808$ left in deposits, which will be deposited in bank D. Bank D can afford to extend a loan for 80 percent

of these additional deposits, or \$0.3846. The household withdraws $\frac{c}{1+c} = 0.0350$ of this in cash. The difference in the amount of the loan and the cash withdrawn, $0.3846 - 0.0350 = 0.3496$, is deposited in Bank D, and the process would continue.

The change in loans made by the banking sector subsequent to this open market purchase is given by the following (infinite) sum:

$$\Delta L = 1 + 0.7272 + 0.5289 + 0.3846 + \dots \quad (31.20)$$

In terms of the general parameters governing cash holding, deposit holding, and reserve holding, this works out to:

$$\Delta L = 1 + \left(1 - \frac{c}{1+c}\right)(1 - rr - er) + \left[\left(1 - \frac{c}{1+c}\right)(1 - rr - er)\right]^2 + \dots \quad (31.21)$$

(31.21) can be written more compactly as:

$$\Delta L = 1 + \frac{1 - rr - er}{1+c} + \left(\frac{1 - rr - er}{1+c}\right)^2 + \left(\frac{1 - rr - er}{1+c}\right)^3 + \dots \quad (31.22)$$

Using facts about infinite sums presented above (e.g. (31.11)-(31.13)), this can be written:

$$\Delta L = \frac{1}{1 - \frac{1-rr-er}{1+c}} \quad (31.23)$$

Which simplifies to:

$$\Delta L = \frac{1+c}{c+rr+er} \quad (31.24)$$

You will note that the expression in (31.24) is *exactly* the money multiplier expression derived above, (31.7). For the parameter values we are using in this continuing example, it works out to 3.6666. This is the change in loans made, which in fact has to equal the change in the money supply since all loans are either held as (i) deposits somewhere in the banking system or (ii) cash. To see how cash in circulation changes, refer back to Table 31.47 and note:

$$\Delta CU = 0.09090 + 0.0661 + 0.0481 + \dots \quad (31.25)$$

In terms of the general parameters, (31.25) can be written:

$$\Delta CU = \frac{c}{1+c} + \frac{c}{1+c} \frac{1-rr-er}{1+c} + \left(\frac{1-rr-er}{1+c}\right)^2 + \frac{c}{1+c} \left(\frac{1-rr-er}{1+c} + \left(\frac{1-rr-er}{1+c}\right)^2\right)^2 + \dots \quad (31.26)$$

(31.26) can be simplified to:

$$\Delta CU = \frac{c}{1+c} \left[1 + \frac{1-rr-er}{1+c} + \left(\frac{1-rr-er}{1+c} \right)^2 + \left(\frac{1-rr-er}{1+c} \right)^3 + \dots \right] \quad (31.27)$$

The term inside brackets in (31.27) simplifies to exactly (31.24), so we are left with:

$$\Delta CU = \frac{c}{c+rr+er} \quad (31.28)$$

(31.28) gives the total change in cash in circulation after the initial open market purchase, which for the parameter values we are using works out to $\frac{1}{3}$. What about the change in deposits? From Table 31.47, for the parameter values we are using this works out to:

$$\Delta DP = 0.90909 + 0.6612 + 0.4808 + 0.3496 + \dots \quad (31.29)$$

In terms of the general parameter values, this can be written:

$$\Delta DP = \left(1 - \frac{c}{1+c} \right) + \left(1 - \frac{c}{1+c} \right)^2 (1-rr-er) + \left(1 - \frac{c}{1+c} \right)^3 (1-rr-er) \quad (31.30)$$

This can be written:

$$\Delta DP = \frac{1}{1+c} \left[1 + \frac{1-rr-er}{1+c} + \left(\frac{1-rr-er}{1+c} \right)^2 + \left(\frac{1-rr-er}{1+c} \right)^3 + \dots \right] \quad (31.31)$$

The term inside brackets in (31.31) reduces to (31.24), so the whole expression in (31.31) can be written:

$$\Delta DP = \frac{1}{c+rr+er} \quad (31.32)$$

For the parameter values we are using, (31.32) works out to 3.3333. One will note that the change in deposits, (31.32), plus the change in cash in circulation, (31.28), equals the total change in loans. This makes sense – all loans are either held as deposits (somewhere inside the banking system) or as cash (outside of the banking system). The change in the money supply equals the sum of the changes in cash plus deposits, which is in turn exactly equal to the change in loans made:

$$\Delta M = \Delta CU + \Delta DP = \frac{1+c}{c+rr+er} \quad (31.33)$$

What about the total change in bank reserves? Recall that the experiment considered in this section involved the central bank initially swapping out \$1 million in government

securities for \$1 million in reserves, but these reserves do not stay with Bank A. From Table 31.47, we see that the total change in reserves for this particular example is:

$$\Delta RE = 0.1818 + 0.1322 + 0.0962 + \dots \quad (31.34)$$

In terms of the general parameters, (31.34) can be written:

$$\Delta RE = (rr+er) \left(1 - \frac{c}{1+c}\right) + (rr+er) \left(1 - \frac{c}{1+c}\right)^2 (1-rr-er) + (rr+er) \left(1 - \frac{c}{1+c}\right)^3 (1-rr-er)^2 + \dots \quad (31.35)$$

(31.35) can be written:

$$\Delta RE = \frac{rr+er}{1+c} \left[1 + \frac{1-rr-er}{1+c} + \left(\frac{1-rr-er}{1+c}\right)^2 + \dots \right] \quad (31.36)$$

The term inside brackets in (31.36) is of course just (31.24), so (31.36) can be written:

$$\Delta RE = \frac{rr+er}{c+rr+er} \quad (31.37)$$

For the parameter values we are using, this works out to $\frac{2}{3}$. Note that the total change in reserves plus the change in cash held by the non-bank public, which is the change in the monetary base, works out to:

$$\Delta MB = \Delta R + \Delta C = \frac{rr+er}{c+rr+er} + \frac{c}{c+rr+er} = 1 \quad (31.38)$$

The total change in the money supply, (31.33), is just the money multiplier times the change in the monetary base. (31.38) reveals an interesting fact – the total monetary base changes by the initial injection of reserves, but this change in the monetary base is split between reserve holdings and cash held by the public. More generally, while this example illustrates that the central bank can influence the monetary base via open market operations, it cannot necessarily directly influence how the base is split between reserves and cash in circulation.

31.4 Two Monetary Episodes: The Great Depression and Great Recession

We have discussed how the money supply is jointly determined by the monetary base (which a central bank can control) and the money multiplier (which a central bank can only influence). For the most part, the money multiplier is reasonably stable (or at the very least

its movements are small and somewhat predictable), so it is not a bad approximation to think of a central bank actually setting the money supply. But this need not always be the case, and there are two recent episodes in US monetary history in which the connection between the monetary base and the money supply broke down in dramatic ways. We briefly discuss each of these in turn.

31.4.1 Great Depression

The Great Depression (1929-1933), as mentioned elsewhere in this book, featured bank runs, widespread banking panics, and a massive decline in the money supply. The left panel of Figure 31.2 plots the behavior of $M1$ and the monetary base in a window starting a couple of years prior to the onset of the recession; the right panel plots the cash-deposits ratio ($c = CU/DP$), the ratio of total reserves to deposits ($RE/DP = rr + er$, so the sum of required and excess reserves), and the money multiplier ($mm = M1/MB$).

Figure 31.2: Money Stock Measures: Great Depression

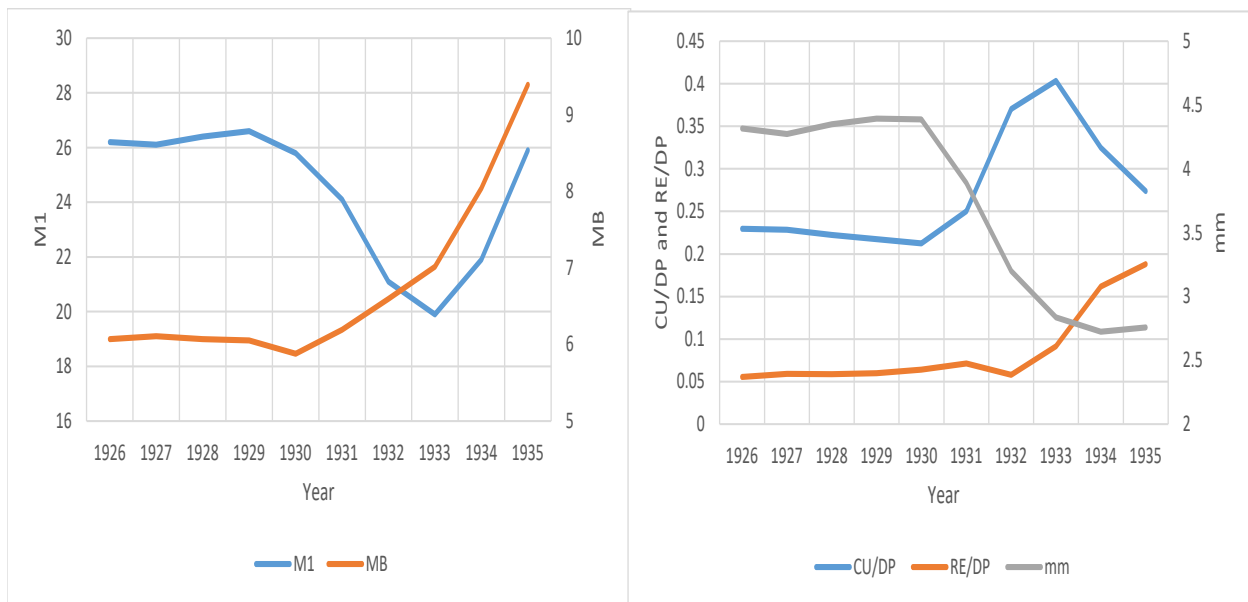

From 1925 through roughly 1930, the monetary base was roughly constant. So too were the cash to deposits and reserves to deposit ratios, and hence the money multiplier and total money supply were also approximately constant. Things changed starting in 1930, which coincides with the beginning of the wave of bank failures in the US. One observes a near doubling of the cash-deposits ratio from 1930 to 1933. Over this period, the money multiplier falls roughly in half (from about 4.5 to 2.5), and the money supply itself declines by more

than one-third. One observes some upward movement in the monetary base from 1930 to 1933, but it was small relative to the decline in the money multiplier.

Tables 31.48-31.50 depict stylized initial balance sheets for the banking system as a whole, the non-bank public, and the Federal Reserve immediately prior to the Great Depression. In this example, the money supply is \$24 billion (currency in circulation plus deposits) and the monetary base is \$6 billion (currency plus reserves). The money multiplier is 4. The public is holding 20 percent of deposits in the form of cash (so $c = CU/DP = 0.2$) and total reserve holdings amount to 10 percent of deposits (so $RE/DP = 0.10$); it does not matter for the purposes of this example whether these are required or excess reserves.

Table 31.48: Stylized Great Depression Banking System Balance Sheet

Assets	Liabilities plus Equity
Loans: \$20 billion	Deposits: \$20 billion
Securities: \$5 billion	
Reserves: \$2 billion	Equity \$7 billion

Table 31.49: Stylized Great Depression Non-Bank Public Balance Sheet

Assets	Liabilities plus Equity
Deposits: \$20 billion	Loans: \$20 billion
Cash: \$4 billion	Equity: \$4 billion

Table 31.50: Stylized Great Depression Fed Balance Sheet

Assets	Liabilities plus Equity
Securities: \$6 billion	Currency: \$4 billion
	Reserves: \$2 billion
	Equity \$0 billion

Suppose that the non-bank public decides that it wishes to increase its cash holding by a total of \$1 billion. The immediate effect of this on the non-bank public balance sheet is:

Table 31.51: Stylized Great Depression Non-Bank Public Balance Sheet: Cash Withdrawal

Assets	Liabilities plus Equity
Deposits: \$19 billion (-\$1 billion)	Loans: \$20 billion
Cash: \$5 billion (+\$1 billion)	Equity: \$4 billion

The immediate effect of this withdrawal on the balance sheet of the banking system as a whole is:

Table 31.52: Stylized Great Depression Banking System Balance Sheet: Cash Withdrawal

Assets	Liabilities plus Equity
Loans: \$20 billion	Deposits: \$19 billion (-\$1 billion)
Securities: \$5 billion	
Reserves: \$1 billion (-\$1 billion)	Equity \$7 billion

The immediate effect of the cash withdrawal is not only to change the composition of the asset side of the non-bank public's balance sheet; there is also a reduction in the size of the banking system's balance sheet because it must meet the withdrawal demand by drawing down reserves. If this is all that happened, there would be no change in the money supply, only a switch in its composition away from deposits towards cash. But this is not all that will happen. In Table 31.48, the banking system is only holding 5.25 percent of its deposits in reserves. Suppose that the banking system either desires to, or is required to, maintain a 10 percent reserve ratio. If the banking system is unable to raise more reserves (either by borrowing or by selling securities, both of which would require the Fed to play an active role either in extending a loan or purchasing government securities), it must reduce its loans outstanding and in the process eliminate deposits. At a disaggregate level reducing loans could amount to selling them to other banks, which would not eliminate deposits, but in the aggregate this is not possible. The banking system as a whole must reduce loans (e.g. eliminate lines of credit, or more likely decline to rollover maturing loans) so as to bring deposits down.²

From (31.52), it is evident that the banking system must reduce loans (and hence deposits) by \$9 billion to restore a reserve-deposit ratio of 10 percent. Its new balance sheet will be:

Table 31.53: Stylized Great Depression Banking System Balance Sheet: Reducing Loans

Assets	Liabilities plus Equity
Loans: \$11 billion (-\$9 billion)	Deposits: \$10 billion (-\$9 billion)
Securities: \$5 billion	
Reserves: \$1 billion	Equity \$7 billion

The new balance sheet for the household after this reduction in loans and resulting decline in deposits is:

²For example, at the time of the Depression the typical mortgage contract in the US featured a 5 year term (as opposed to the now commonplace 30 year mortgage contract). Most borrowers did not plan to retire their mortgages within five years but rather to roll them over into a new mortgage by refinancing. Forced to raise cash, banks would fail to issue new mortgages on maturing five year loans.

Table 31.54: Stylized Great Depression Non-Bank Public Balance Sheet: Reduction in Loans

Assets	Liabilities plus Equity
Deposits: \$10 billion (-\$9 billion)	Loans: \$11 billion (-\$9 billion)
Cash: \$5 billion (+\$1 billion)	Equity: \$4 billion

After all of this has transpired, the balance sheet of the central bank will be:

Table 31.55: Stylized Great Depression Fed Balance Sheet: After Cash Withdrawal and Loan Reduction

Assets	Liabilities plus Equity
Securities: \$6 billion	Currency: \$5 billion (+\$1 billion)
	Reserves: \$1 billion (-\$1 billion)
	Equity \$0 billion

Note from Table 31.55 that the monetary base is unchanged after the cash withdrawal, although the composition of the base has changed. Cash has migrated from inside the banking system (reserves) to currency in circulation. The money supply itself has declined. After the banking system adjusts so as to restore its desired reverse-deposit ratio, the money supply is \$15 billion, down from \$24 billion prior to the cash withdrawal. This means that the money multiplier has fallen to 2.5 (i.e. 15/6), which can also be seen from the formula $mm = \frac{1+c}{c+RE/DP}$ when the new $c = 0.5$.

Similarly to how an injection of reserves (e.g. from an open market operation) can result in a *multiple* expansion of deposits and hence of the money supply, a withdrawal of reserves (e.g. from unexpectedly high cash withdrawals during a banking panic) can lead to a *multiple* contraction of deposits and hence of the money supply. This is roughly consistent with what happened during the Great Depression. To keep the money supply from falling, the Fed would have needed to inject reserves into the banking system to counter the cash outflow. It essentially did not do this until the Depression was well underway.

31.4.2 Great Recession

In an effort to fight the Great Recession of 2007-2009 and avoid the mistakes of the Great Depression, the Federal Reserve engaged in a massive expansion of its balance sheet. It did so through three different channels: (i) emergency lending to banks and other financial institutions (e.g. through the discount window but also through non-standard lending facilities, some of which are discussed in Chapter 36); (ii) purchases of mortgage-related debt;

and (iii) purchases of longer maturity US government debt. Figure 31.3 below shows the evolution of the asset side of the Federal Reserve’s balance sheet over the last several years.

Figure 31.3: Federal Reserve Assets



Prior to the Great Recession, the total assets on the Fed’s balance sheet totaled slightly less than \$1 trillion and consisted mostly of short maturity Treasury securities (i.e. Treasury Bills). These are the typical “securities” that central banks buy and sell to conduct open market purchases. In large part due to the zero lower bound and the run on financial institutions, the Fed engaged in several extraordinary actions that resulted in a massive expansion of the Fed’s balance sheet. First, it extended credit to financial institutions. Second, it bought large quantities of non-standard debt (both longer maturity Treasury securities and mortgage-related debt).

Table 31.56 provides a stylized Fed balance sheet *prior* to the onset of the Crisis. We show the Fed as having liabilities totaling \$800 billion, of which \$700 billion is currency in circulation and \$100 billion is reserves. On the asset side, we show the Fed as holding \$800 billion in “traditional” securities (mostly short term US government debt) and no outstanding loans to financial institutions. For the purposes of this example, we assume that the Fed has zero equity.

Table 31.56: Stylized Great Recession Fed Balance Sheet: Before the Crisis

Assets	Liabilities plus Equity
Traditional Securities: \$800 billion	Currency: \$700 billion
Loans to Financial Institutions: \$0 billion	Reserves: \$100 billion
	Equity \$0 billion

Table 31.56 shows a hypothetical and highly stylized balance sheet for the banking system as a whole prior to the crisis. We show the system as holding \$1 trillion in loans, \$1 trillion in Treasury securities (\$800 billion of which are longer term) and \$100 billion in assets. The only liabilities shown are deposits of \$700 billion.³

Table 31.57: Stylized Great Recession Banking System Balance Sheet: Before the Crisis

Assets	Liabilities plus Equity
Loans \$1 trillion	Deposits: \$700 billion
Long Term Treasuries: \$800 billion	
Short Term Treasuries: \$200 billion	
Reserves \$100 billion	Equity \$1.4 trillion

In terms of these T-accounts, we can think about the Fed's non-standard interventions as taking three forms: (i) loans to institutions, (ii) purchases of loans (think of these loan purchases as mortgages), and (iii) purchases of longer term Treasury Securities. To finance these purchases and allow its balance sheet to expand in size, the Fed simply created reserves and credited the reserve balance accounts of the financial institutions selling securities. We show the Fed's balance sheet expanding by \$2.5 trillion, which is roughly consistent with the experience in the aftermath of the recession. This expansion of the balance sheet was financed by the creation of reserves.

Table 31.58: Stylized Great Recession Fed Balance Sheet: After the Crisis

Assets	Liabilities plus Equity
Traditional Securities: \$800 billion	Currency: \$700 billion
Long Term Treasuries: \$700 billion (+\$700 billion)	Reserves: \$2.6 trillion (+\$2.5 trillion)
Loans to Financial Institutions: \$1 trillion (+\$1 trillion)	
Mortgage Securities: \$800 billion (+\$800 billion)	Equity \$0 billion

In our stylized example, the banking system's balance sheet would be affected as follows:

³We should be clear that the balance sheets depicted in this section are meant to be stylistic. Of course, the banking system has other sources of liabilities than just demand deposits and holds other types of assets and securities than those considered here.

Table 31.59: Stylized Great Recession Banking System Balance Sheet: After the Crisis

Assets	Liabilities plus Equity
Loans \$200 billion (-\$800 billion)	Deposits: \$700 billion
Long Term Treasuries: \$100 billion (-\$700 billion)	Borrowings: \$1 trillion (+\$1 trillion)
Short Term Treasuries: \$200 billion	
Reserves \$2.6 trillion (+\$2.5 trillion)	Equity \$1.4 trillion

The sale of mortgage-related securities and longer term Treasury securities involves a change in the composition of the banking system's assets: these assets decline in value and reserves increase by an equal amount. The addition of borrowings from the Fed increases the liability side of the balance sheet and is reflected in higher reserve balances. All told, the extraordinary measures resulted in an infusion of more than \$2 trillion in reserves into the banking system (in both the data as well as in our stylized example).

In theory, the infusion of reserves, albeit through non-standard means, could have an effect on the supply of money through the similar multiple deposit creation channel outlined earlier. Prior to the crisis, the banking system (in our stylized example) maintained a reserve balance of about 10 percent. The injection of reserves significantly increases the reserve-deposit ratio, and in principal allows for the banking system to issue new loans and in the process create more deposits.

In practice, this did not happen. Figure 31.4 plots the behavior of the money supply as measured by M1 and the monetary base in the left panel. In the right panel we plot the money multiplier, the cash-deposit ratio, and reserve-deposit ratio.

Figure 31.4: Money Stock Measures: Great Recession



Unlike the Great Depression, the money supply (as measured by M1, but also as measured by M2), increased over the duration of the Great Recession, albeit not at a particularly extraordinary pace relative to a pre-recession trend. The monetary base, in contrast, increased at an extraordinary pace, so much so that by the end of 2008 it *exceeded* the M1 money supply (so that the money multiplier was less than one). The large decline in the money multiplier shown in the right panel (from about 1.5 pre-crisis to less than 1 post-crisis) is driven almost entirely by the massive increase in the reserve-deposit ratio. In contrast, the cash-deposit ratio was roughly stable over this time period. In essence, the reserves that the Fed created due to its extraordinary actions remained as reserves and did not become money in the usual sense.⁴

31.4.3 Fractional Reserve Banking

A fractional reserve banking system refers to a banking system in which private banks are only required to hold a fraction of deposits as reserves. A fractional reserve banking system makes both banks (through their choice of how many reserves to hold) and households (through their choice of how much cash to hold) co-players in setting the money supply. During normal circumstances a central bank can effectively control the money supply through adjustment of the monetary base, but in unusual circumstances the relationship between the base and the money supply can break down due to the actions of the private sector.

A natural question that from time-to-time pops up is why not eliminate fractional reserve banking? If fractional reserve banking were eliminated, a central bank could perfectly control the money supply through its adjustment of the monetary base. To see this, refer back to (31.7). If $rr = 1$ (i.e. the required reserve ratio is 100 percent), then the money multiplier is 1 regardless of what the cash-deposit ratio is (note that if $rr = 1$, then $er = 0$, because $rr + er \leq 1$). Then the money supply is simply equal to the monetary base, which the Fed can control.

If the inability to control the money supply is a problem (as it has been at times in the past), calls for a 100 percent reserve requirements make a modicum of sense. There has been renewed interest recently in so-called full reserve banking. Full reserve banking would eliminate the problem of bank runs and would give central banks complete control of the money supply. But it would be problematic along other dimensions. As we discuss in

⁴There is an interesting difference between the cash-deposit ratios in Figure 31.4 and 31.2. The cash-deposit ratio is nearly *four* times larger now than it was at the time preceding the Depression. Given technological advances in payments technology, this might strike one as odd. What has in fact driven the behavior of the cash-deposit ratio is not so much that households are holding cash in lieu of deposits, but rather that households have greatly economized on deposits by substituting into slightly less liquid assets like money market mutual funds (which did not exist at the time of the Depression).

Chapters 30 and 32, an important function of financial intermediation is maturity or liquidity transformation – financial intermediaries like banks take in funds from households who have a desire for liquidity and invest the funds in longer term, less liquid assets like loans. This gives households access to the liquidity they desire but also the opportunity to indirectly invest in higher return assets. Eliminating the ability of banks to engage in maturity transformation by investing some fraction of deposited funds would incentivize this type of intermediation to move out of the regulated banking sector, which could itself lead to unforeseen problems.

31.5 Summary

- The central bank controls the monetary base which is defined as currency in circulation plus reserves. However, the central bank does not control the overall money supply which is the product of the monetary base and the money multiplier. The money multiplier in turn is a function of the cash deposit ratio, the required reserve ratio, and the excess reserve ratio. The central bank only controls the second of these ratios.
- The money multiplier steadily declined in the 20 years prior to the Great Recession. During the Great Recession the money multiplier declined sharply and has not subsequently rebounded.
- Central banks primarily affect the money supply by engaging in open market operations which involve the buying or selling of government securities.

Questions for Review

1. What has happened to the excess reserve ratio since the Great Recession?
2. After the financial crisis, the Fed started paying interest on reserves. Explain what affect this would have on the money supply.
3. Suppose the central bank intends to contract the money supply. Explain what action it should take to accomplish this objective and how this action affects the balance sheets of banks and the central bank.

Chapter 32

A Model of Liquidity Transformation and Bank Runs

In Chapter 30 we studied the basic balance sheet management of banks and discussed how banks play a potentially important role in mitigating asymmetric information between borrowers and savers. In this chapter we build off of this analysis by studying the other benefit of financial intermediation – liquidity transformation. One reason individuals might be weary to directly fund investment projects is that these projects are long term and illiquid (illiquid in the sense of not being easy to get one’s money out of the project on short notice). Households might be uncertain as to when they will need to withdraw their money from a project. They might therefore be unwilling to directly fund projects. Banks, or financial intermediaries more generally, can step in and engage in liquidity transformation. Banks can take in deposits, fund longer term illiquid projects, and in the process create liquid assets (in the simple exposition of this chapter these assets are demand deposits). As we will see, the economy as a whole can be better off because of liquidity transformation. But the process of liquidity transformation is susceptible to what we call runs. Banks (or the banking system more generally) are subject to *runs* in the sense that banks cannot honor all their short term liabilities at once. This susceptibility to runs has been a problem throughout history and played a central role in the recent financial crisis and Great Recession, as we will discuss in Chapter 36.

We will work through a simplified version of the [Diamond and Dybvig \(1983\)](#) model and will illustrate the benefits and precariousness of liquidity transformation through examples. The exposition in this chapter will closely follow [Diamond \(2007\)](#), who provides a simple exposition of the more general [Diamond and Dybvig \(1983\)](#) model. Interested readers looking to delve further into the subject of liquidity transformation and bank runs are encouraged to read these papers.

32.1 Model Assumptions

Time exists for three periods. Period t is the present, $t + 1$ is one period in the future, and period $t + 2$ is two periods in the future. There exists an investment opportunity which costs 1 unit to fund in period t . If the funding is left in the project until period $t + 2$, the

project offers a (gross) return of r_2 (note that the gross return is one plus the net return). If an investor takes her money out of the project “early” in period $t + 1$, a process we will refer to as *liquidation*, the project offers a gross return of r_1 . We will assume that $r_1 \leq r_2$. In other words, there is a penalty (in the form of a lower return) for early liquidation.

We will call the ratio, $\frac{r_1}{r_2}$, a measure of the liquidity of the project. The idea that the return from early liquidation would be lower than the return from holding the investment until completion of the project does not seem particularly controversial. For example, asymmetric information problems might dictate that selling of claims to the cash flow from a building project would have to be at a discount from the true expected returns – people will assume that if someone is trying to sell such claims that the project must not be going well.

There are many, identical households. The representative household is endowed with one unit in period t . The household has no need to consume in period t . The household is uncertain over when she will need to consume in the future, however. With probability $p \in [0, 1]$, the household will need to consume in period $t + 1$. With probability $1 - p$, the household can wait until period $t + 2$ to consume. Think of this example as forced early retirement. With probability p , you are forced to retire at age 60 and need to start drawing down your investments. With probability $1 - p$, in contrast, you can wait to retire until age 65. It is, of course, possible to generalize this to more than two possible dates when the household will need to consume.

A household’s expected utility is simply the probability weighted sum of utilities from consumption in each of the two subsequent periods (recall that the household has no need to consume in period t). In particular:

$$E(U) = pu(C_{t+1}) + (1 - p)u(C_{t+2}) \quad (32.1)$$

In (32.1), we are making the simplifying assumption that there is no discounting of utility flows in either $t + 1$ or $t + 2$ relative to the present, period t . This assumption doesn’t fundamentally change any of the analysis but simplifies the exposition. $u(\cdot)$ is the utility function with the usual properties. For example, we could have $u(C_{t+1}) = \ln C_{t+1}$.

The household has no need to consume in period t , and if it consumes in $t + 1$ it will not consume in $t + 2$ (and vice-versa). Thus, if the household invests one dollar in the project, it will have consumption of r_1 if it needs to consume in period $t + 1$ and r_2 if it can wait until $t + 2$. The household has an outside option of simply storing its wealth in cash. We assume that the net return on holding cash is zero, so if the household stores one dollar in cash it will have one unit of consumption regardless of which period it must consume in. As the example below shows, provided that $u(\cdot)$ is concave (meaning that the household is risk-averse), the household may choose to hold cash even if a project offers a positive expected net return.

This desire to hold cash rather than invest in a project with a higher expected net return is driven by the household's desire for liquidity – if the household is uncertain over *when* it will need access to its savings, holding expected returns fixed the household will prefer the more liquid savings vehicle (in the example with which we are working, cash compared to the investment project).

Example Suppose that the household's utility function is the natural log. Suppose that the investment opportunity pays a gross return of $r_1 = 0.5$ if liquidated early and $r_2 = 1.5$ if held until period $t + 2$. Suppose that the probability that the household will need to consume in $t + 1$ is $p = 0.4$; hence the probability that the household can wait to consume until $t + 2$ is 0.6.

What is the expected utility from investing in the project? It is:

$$E(U) = 0.4 \times \ln(0.5) + 0.6 \times \ln 1.5 = -0.034 \quad (32.2)$$

What is the expected utility from simply holding cash? It is:

$$E(U) = 0.4 \times \ln 1 + 0.6 \times \ln 1 = 0 \quad (32.3)$$

Since the expected utility of holding cash is higher than the expected utility of investing in the project (i.e. > -0.034), the household will choose to simply hold cash. The project will not get funded. This is in spite of the fact that the project offers a positive expected return – $0.4 \times 0.5 + 0.6 \times 1.5 = 1.1$, so the expected net return on the project is 10 percent in comparison to the expected net return on cash of 0 percent. The difference is that the return on cash is certain, whereas the return on the investment project is uncertain depending on when it is liquidated.

32.2 Enter a Bank

In the model setup, an individual household may not choose to fund a risky investment project, even if that project offers a higher expected return than cash does. This is because the household values liquidity – it is not certain when it will need its funds back, and if it has to withdraw early from the investment project it may do so at a loss.

Suppose that many households pool their resources together through a financial intermediary, which we will call a bank. For simplicity, we will think of this as a “mutual bank” – the bank is not seeking to make a profit, has no equity, and is not trying to increase its

equity. In this sense, the bank of this chapter is substantially simpler than what is described in Chapter 30 or the real world.

Suppose that there are L identical households. These households are identical ex-ante, but ex-post a fraction p will need to consume in $t + 1$ and $1 - p$ will need to consume in $t + 2$. As of period t , any particular household does not know whether it will need to consume in $t + 1$ or $t + 2$ – it only knows the probabilities. Assume that L is sufficiently large so that, with certainty, exactly $p \times L$ of the households will need to consume in period $t + 1$, while $(1 - p) \times L$ can wait until $t + 2$. In this way, there is no aggregate uncertainty, just uncertainty at the individual level over when a household will need its funds back.

The question is whether a bank, by pooling resources from the households, can simultaneously invest in the investment project (assume that the investment project is scalable in the sense that r_1 and r_2 are unaffected by the amount invested) yet offer the households an asset which they prefer to cash. Intuitively, the process works as follows. The bank can accept deposits from the households in period t . This gives the bank L units of funds. Suppose that the bank offers the households an interest rate on deposits of $r_d \geq 1$. If the household deposits one unit in t and withdraws in $t + 1$, it will get r_d back. If it waits to withdraw until $t + 2$, it gets r_d^2 . If $r_d > 1$ and the household perceives no uncertainty over this return, then the household will prefer deposits to holding cash. If the bank can offer $r_d > 1$, then it has engaged in what we will call *liquidity transformation*. By this we mean that, by pooling resources and playing probabilities with a large number of depositors, the bank *creates* an asset that is more liquid than the project in which it is investing.

The process is best seen with an example. The example we consider builds off the previous example.

Example Continue with the setup in the previous example. The investment project promises $r_1 = 0.5$ if liquidated early and $r_2 = 1.5$ if held until period $t + 2$. The probability a household will need to consume in $t + 1$ is p , and the probability that the household will need to consume in $t + 2$ is $1 - p$. The representative household's utility function is the natural log. Assume that there are $L = 1000$ households. $p = 0.4$, so $1 - p = 0.6$. This means that 400 households will want their funds back in $t + 1$, while the other 600 will not need to withdraw until $t + 2$.

Since the investment project pays less than 1 if sold in $t + 1$, the bank will want to store the amount of cash that it anticipates needing to pay out in $t + 1$. Let S be the amount the bank stores. The amount it stores will need to satisfy $400r_d = S$. The bank will invest the other $1000 - S$ deposits into the investment project, which will yield $r_2(1000 - S)$. This must be paid out to the remaining 600 depositors,

so we must have $600r_d^2 = r_2(1000 - S)$. All proceeds are paid out to depositors since the mutual bank is not trying to make a profit. In other words, we have a system of two equations in two unknowns:

$$400r_d = S \quad (32.4)$$

$$600r_d^2 = 1.5(1000 - S) \quad (32.5)$$

The two unknowns are S and r_d . If you combine these two equations, we can get a quadratic equation in r_d alone. This quadratic equation can be simplified to:

$$r_d^2 + r_d - 2.5 = 0 \quad (32.6)$$

We can then use the quadratic formula to solve for r_d .¹ Focusing on the positive solution, we get $r_d = 1.1583$, or a net interest rate on deposits of almost 16 percent. This means that the bank will need to keep $S = 463.32$ in cash on hand to meet expected withdrawal needs in $t + 1$. It will invest the remaining 536.68 in the investment project, which will yield 805.02 in income in period $t + 2$. This can be distributed to the remaining 600 households for a total return of 1.3417, which when expressed at a period rate (i.e. take the square root) is exactly $r_d = 1.1583$. The household will clearly prefer deposits to cash (and in turn would prefer cash to investing in the actual project directly). The expected utility from depositing with the bank is:

$$E(U) = 0.4 \times \ln 1.1583 + 0.6 \times \ln 1.1583 = 0.1470 \quad (32.7)$$

This expected utility is higher than the expected utility from holding cash (which is zero). Hence, the household will prefer deposits to cash.

Note that the bank has created an asset (deposits) which is itself more liquid than the project. The liquidity of the project is $\frac{r_1}{r_2} = \frac{1}{3}$. The liquidity of deposits is $\frac{r_d}{r_d^2} = \frac{1}{r_d} = 0.8633$. The bank has created liquidity. This is liquidity transformation in action.

As we see in the example above, by pooling resources the bank can create an asset (deposits) that is more liquid than the project in which the bank is investing. In doing so,

¹Note that for a general quadratic equation $ax^2 + bx + c = 0$, the solution is $x = \frac{-b \pm \sqrt{b^2 - 4ac}}{2a}$.

the bank can offer the household a better return than cash. This makes households better off. It also makes firms (which are not modeled) better off because without a bank firms don't get funding, but with a bank they do.

32.3 Bank Runs

Through the process of financial intermediation and liquidity transformation, everyone *can* win. But *do* they necessarily win? The answer turns out to be maybe not. One of the main benefits of banking, or financial intermediation more generally, is the process of liquidity transformation. But the process of liquidity transformation is precarious and susceptible to what are called *runs*. Runs are situations in which depositors who don't need their funds in $t + 1$ nevertheless seek to withdraw. Why might they do this? They might do this should they be concerned that the bank won't be able to make good on its promised return in $t + 2$. This could happen if, for example, households begin to doubt the health of the underlying investment project. It can also happen if households simply expect other households to run, even if there is no issue at all with the health of the underlying project in which the bank is invested.

How would this work? Suppose that you are one of the L households in the economy who has deposited one unit in the bank in period t in exchange for a deposit which promises to pay r_d (gross) if withdrawn in $t + 1$ and r_d^2 if withdrawn in $t + 2$. Suppose that period $t + 1$ arrives and uncertainty is resolved, and you do *not* need to consume in $t + 1$. But nothing stops you from withdrawing in $t + 1$. If you withdraw in $t + 1$, you get consumption of r_d and utility of $\ln r_d$. Would it ever make sense to withdraw in $t + 1$ even if you do not have to? Yes, it would make sense if you think that your return from withdrawing in $t + 2$ will be less than r_d . The bank may have promised you a gross return of r_d^2 for not withdrawing until $t + 2$, but nothing guarantees that the bank will have the funds to pay you that amount back. This could happen if, at $t + 1$, you get news that the investment project is not doing as well as anticipated, and will pay out less than r_d^2 . It could also happen with no change in the expected return on the investment project if you think that *other* households who do not need to withdraw in $t + 1$ will nevertheless withdraw. If more than $p \times L$ try to withdraw in $t + 1$, then the bank will not be able to pay out the promised r_d^2 in $t + 1$. If you think that enough others are going to withdraw, then the your return from keeping the money in the bank could be lower than the return from withdrawing immediately.

As before, the possibility of a “run” is best seen through the lens of an example. We will continue with the example begun above.

Example

Continue with the setup from above. The bank offers depositors $r_d = 1.1583$. The bank has stored 463.32 in cash to meet anticipated withdrawal demands in $t + 1$, and invested the remaining 536.68 in the investment project.

Suppose that period $t + 1$ arrives and you are revealed as *not* needing to consume in $t + 1$. There is no change in the expected profitability of the bank's investment. But you think that $H \geq 0$ of the 600 households who *do not* need to consume in $t + 1$ are going to withdraw their funds in $t + 1$. At what value of H does it make sense for you to also withdraw your funds?

The bank will need to pay out $r_d H$ for each additional, unexpected withdrawal in $t + 1$. The bank does not, in the example with which we have been working, have the cash on hand to meet these withdrawals. In order to come up with some cash, the bank will have to sell off some of the investment project. Selling one unit of the project only generates $r_2 = 0.5$ in cash. This means that the bank will need to sell 2 units of the investment project for each dollar of cash it needs to generate. This means that the bank will have to sell $2 \times 1.1583 \times H$ units of the investment. This leaves the bank with $536.68 - 2.3166H$ units invested in the project. This remaining amount will generate a return of $r_2 = 1.5$, so that the bank will have $1.5 \times (536.68 - 2.3166H)$ in income in period $t + 2$. This can be distributed to the remaining $600 - H$ depositors who do not withdraw in $t + 1$. The (gross) return to these depositors is then:

$$\tilde{r}_d = \frac{1.5 \times (536.68 - 2.3166H)}{600 - H} \quad (32.8)$$

For you to *not* want to withdraw, this modified return must be greater than the return on withdrawing in $t + 1$, which is $r_d = 1.1583$:

$$\tilde{r}_d = \frac{1.5 \times (536.68 - 2.3166H)}{600 - H} \geq 1.1583 \quad (32.9)$$

If we work out the math, we get:

$$805.02 - 3.4749H \geq 694.98 - 1.1583H \quad (32.10)$$

Which works out to:

$$H \leq 47.50 \quad (32.11)$$

In other words, if you think that 48 other households who do not need to consume in $t + 1$ will nevertheless withdraw, then it makes sense for you to also withdraw. If 48 withdraw, then the bank will have to sell $2.3166 \times 48 = 111.1968$ of the investment project off, leaving it with 425.4832 invested. This will yield $1.5 \times 425.4832 = 638.2248$ in income in period $t + 2$. This can be distributed to the $600 - 48 = 552$ households who have no yet withdrawn, for a realized return of $\frac{638.2248}{552} = 1.1562$. Since this is less than the 1.1583 you can get from withdrawing in $t + 1$, it is optimal to withdraw in $t + 1$.

As the above example illustrates, even if there is nothing fundamentally wrong with the investment project the bank has undertaken on behalf of its depositors, the bank is susceptible to a run. This is the pernicious side of liquidity transformation. The bank may have created a liquid asset (deposits), but if too many depositors want their funds back before the investment project has paid off, the bank has a problem. It may not be able to honor its promised return on deposits held until $t + 2$, and, if enough households try to withdraw in $t + 1$, the bank may not be able to honor the promised return on deposits held until $t + 1$ either. In this situation, the bank could become insolvent.

Call H the cutoff number of households who do not need their funds in $t + 1$, who are nevertheless expected to withdraw in $t + 1$, above which it is optimal for any household who does not need to withdraw in $t + 1$ to nevertheless try to withdraw. All households in the economy know what this H is (in the example above, it is 47.50). Households who do need to withdraw in $t + 1$ are exogenously endowed with a belief that G households who do not need to withdraw in $t + 1$ will withdraw. This belief about G is common to all households and is completely exogenous. There will be two different equilibria. If $G \leq H$, then no households who do not need their funds in $t + 1$ will withdraw. If $G > H$, in contrast, all households will withdraw, and the bank will become insolvent. The former is the “good” equilibrium, while the latter is the “bad” bank run equilibrium.

We illustrate the outcomes of these two equilibria continuing with the example with which we have been working:

Example We know from above that the cutoff value $H = 47.5$. If $G \leq 47.50$, then only those households who need their funds in $t + 1$ will withdraw. These households will get back $r_d = 1.1583$, while the remaining 600 households will get $r_d^2 = 1.3417$ by waiting to withdraw until $t + 2$. This is the “good” equilibrium.

In the “bad” equilibrium, $G > H$ and all households try to withdraw in $t + 1$. The bank has 463.62 in cash to meet withdrawal demands. The maximum amount of additional cash that the bank can raise is $\frac{1}{2}536.68 = 268.34$. This means that the

maximum amount of cash that the bank can pay out in $t + 1$ is 731.96. This only meets the withdrawal demands of 631.926 households. In other words, the first 632 households (rounding up) will get their money plus promised interest back in $t + 1$, but about 368 households will lose everything.

We can think about these two equilibria in the context of the bank's balance sheet. Recall that the mutual bank in our example has no equity and is not seeking to grow equity. In the good equilibrium the bank is solvent in the sense that its equity will be exactly zero – its assets are worth exactly what its liabilities are. The bank holds two assets – 463.62 in cash, and 536.68 in the investment. The bank's liabilities are its deposits. The bank owes r_d for each deposit withdrawn in $t + 1$ and r_d^2 for each deposit withdrawn in $t + 2$. The difference between the good and bad equilibria is how the investment is valued. In the bad equilibrium, the investment is only worth 0.5 each, and the bank's liabilities are valued at $r_d 1000$. The balance sheet in the bad equilibrium is:

Table 32.1: T-Account for Bank in Bad Equilibrium

Assets	Liabilities plus Equity
Investment: 268.34	Deposits: \$1158.30
Cash Reserves: 463.62	Equity -426.34

In the bad equilibrium, the bank is insolvent in that it has negative equity – its liabilities exceed the value of its assets. In the good equilibrium, in contrast, the investment is valued at 1.5 each. The bank's liabilities are $r_d \times 400 + r_d^2 \times 600 = 1268.3$. Its balance sheet is:

Table 32.2: T-Account for Bank in Good Equilibrium

Assets	Liabilities plus Equity
Investment: 805.02	Deposits: \$1268.30
Cash Reserves: 463.62	Equity 0

In the good equilibrium, the bank is solvent in the sense that its assets are worth exactly what its liabilities are worth.

There are a couple of useful insights that can be gleaned from the example worked out above. First, in the bad equilibrium the bank becomes insolvent because it is forced to liquidate the investment at a lower price than it anticipated. Second, in the bad equilibrium a number

of depositors have their wealth wiped out, with all the attendant negative macroeconomic consequences that would come with that. Third, given an exogenous perception about the number of households who will withdraw earlier than needed (G in the notation above), the bad equilibrium is completely rational in the sense that trying to withdraw early is the optimal thing to do if you believe that enough other households are also going to withdraw early. In other words, a bad, bank run equilibrium is *not* the consequence of irrational fears. The fears are quite rational, given a belief about what other households are going to do. If enough other households withdraw earlier than needed, then the bank really will be insolvent.

There is a way for the bank to behave in such a way as to make the bad, bank run equilibrium less likely. That is to store more cash than it anticipates needing to pay out in period $t + 1$. But this is not without a cost. While it would increase the cutoff value of H above which the bank run will happen, storing more cash (i.e. holding more liquidity) means that the bank cannot offer households as good of an interest rate on deposits. In other words, the most direct way to reduce the vulnerability to a bank run is to limit the amount of liquidity transformation that takes place. The possibility of the bank becoming insolvent can be completely eliminated by the bank simply storing cash (i.e. so-called full reserve banking), but then there is no liquidity transformation taking place.

32.4 Policies to Deal with Bank Runs

Banking panics were a common feature of American economic life throughout the 19th century and into the Great Depression, which featured wide-scale bank runs and many bank closures. The Federal Reserve was founded in 1913. The chief motivation for its founding was not the day-to-day manipulation of the money supply and interest rates as we have focused on (see, e.g. Chapter 27). Rather, the Fed was founded to serve as a lender of last resort, with the idea that this would eliminate banking panics. This proved to not be sufficient during the Great Depression, where many economists feel that the Fed failed in its role as lender of last resort.

Given that banking panics were frequent, it should come as no surprise that even before federal policy attempted to deal with them, the private sector tried to come up with ways to limit the harm from bank runs. In the 19th century and early 20th century (before the founding of the Fed), banking panics were dealt with by localized “clearinghouses,” which were consortiums of banks in a city. During a time of panic where depositors rushed en masse to withdraw their deposits, banks would band together under the auspices of the clearinghouses. The first major thing that the clearinghouses would do is to *suspend convertibility*. In other words, banks would jointly agree to *not* meet deposit withdrawal

demands with cash (either at all or only up to a particular amount). In some instances, withdrawal demands would not be met with currency but rather with clearinghouse certificates, which were like demand deposits on the consortium of banks, not just a particular bank.

The logic behind suspension of convertibility is fairly easy to understand in the context of the model developed in this chapter. Suppose, following the examples laid out above, that 40 percent of depositors will need to withdraw their deposits in period $t + 1$. Suppose that you are one of the 60 percent of depositors that has the option of withdrawing in period $t + 1$ but can wait until period $t + 2$. You may find it optimal to withdraw in period $t + 1$ if you think enough other depositors who do not need their funds in period $t + 1$ will choose to withdraw anyway. If the bank announces that it will not honor withdrawal demands above a certain threshold (say, it will not pay out more than \$463.62 in cash), however, then you have no incentive to withdraw in $t + 1$, even if you think that some others might choose to do so. This is because if you know that the bank is not going to honor withdrawal demands above a certain threshold, the bank will be able to pay you your promised return in $t + 2$. A credible announcement of the suspension of convertibility ought to prevent a bank run from starting and ought to stop it in its tracks once started.

Another thing that the clearinghouses did was to band together and collude to *not* publish bank-specific information about assets and liabilities. You might choose to run on your bank if you think that the bank has made bad investments and that its assets are worth less than previously thought. Withdrawing from the bank could cause otherwise healthy banks to have problems – if your bank tries to sell assets to come up with cash, then this will depress the prices of assets, which will make other banks look weak. By not publishing bank-specific balance sheet information, the clearinghouses hoped to stop this process in its tracks. The idea is that the consortium of banks would stand together as one – because banks are interconnected through the market prices of the assets they hold, reducing information about the health of particular banks reduced the incentive for depositors to run on these banks, which limited the amount of assets that needed to be sold to come up with cash. The Federal Reserve implemented a similar procedure during the recent financial crisis with the Term Auction Facility (TAF), as we will discuss in Chapter 36.

While suspension of convertibility was used as the primary defense mechanism against bank runs prior to the founding of the Fed, it did not in practice prevent runs (although many scholars believe suspension of convertibility lessened the severity of banking panics). Further, suspension of convertibility was not without its own problems. If a bank suspends convertibility, then there may well be depositors who need to access their funds who cannot. This is undesirable. For these reasons, in the wake of the famed Panic of 1907, the Federal Reserve was founded in the United States in 1913. Among other day-to-day operational

details, the Fed’s mandate was to stand as a *lender of last resort* to banks facing a liquidity crisis. The discount window was introduced as a facility wherein commercial banks could borrow from the Fed in the event of a liquidity crisis. How this was intended to work is best seen through an example. Suppose that a bank begins with a balance sheet as follows:

Table 32.3: T-Account for Hypothetical Bank

Assets	Liabilities plus Equity
Loans: \$100	Deposits: \$100
Securities: \$10	Borrowings: \$0
Cash Reserves: \$10	Equity \$20

Suppose that the bank faces a withdrawal of \$40. It only has \$10 in cash reserves and can only raise \$10 through the selling of securities. Raising more liquidity through the sales of loans might require selling at a loss. Instead of selling loans, a bank could instead borrow from the Fed directly through its discount window. The bank could draw down its cash reserves and sell its securities to come up with \$20 in cash, and could borrow the other \$20 from the Fed. The new balance sheet would look like:

Table 32.4: T-Account for Hypothetical Bank

Assets	Liabilities plus Equity
Loans: \$100	Deposits: \$60
Securities: \$0	Borrowings: \$20
Cash Reserves: \$0	Equity \$20

In this way, through the discount window the bank can attract more liabilities (borrowings) to make up for an unexpected withdrawal, which can allow it to meet that withdrawal without being forced to sell assets. This is not necessarily a freebie for the bank – it has to pay interest on the loan from the Fed (at the so-called discount rate), which means that in a dynamic sense there is a cost to lacking liquidity and having to go to the Fed for help. But in a liquidity-driven panic going to the Fed for funds at a small interest rate is likely a better deal than selling illiquid assets at a loss.

The hope was that the existence of the Fed and its discount window would eliminate bank runs. If banks were run on, they could go to the Fed for liquidity, which would stop the run in its place. Furthermore, private sector expectations of banks making use of the discount window might stop runs before they start. In the context of the model we have developed and studied in this chapter, if you do not need your funds in $t + 1$, the only reason you would withdraw is if you believe that you will suffer a loss by waiting until $t + 2$. But if you believe

that a bank will make use of the central bank's discount window, you should not have any reason to fear a loss, and should not withdraw earlier than needed.

The lender of last resort function and the discount window did not work as planned during the Great Depression, which featured waves of bank runs. In part this was because the Fed itself did not fully understand and appreciate its role as lender of last resort, as argued for example in [Friedman and Schwartz \(1971\)](#). In part this was because of a stigma associated with going to the discount window for a loan. Banks feared that if they went to the discount window, they would be perceived as financially unsound, which would increase the pressures on the bank.

The most recent policy to deal with bank runs was the institution of deposit insurance. This happened with the creation of the Federal Deposit Insurance Corporation (FDIC) in 1933. The basic idea of deposit insurance is as follows. Banks can choose to purchase deposit insurance for a small fee. In exchange for this small fee, deposits at a bank are insured by the FDIC up to a given amount. Initially deposits were insured up to \$2500; today the limit is \$250,000. By “insured” we mean that in the event that the bank becomes insolvent and cannot meet withdrawal demands, if it is FDIC insured then the FDIC will step in and provide those funds. The idea behind the FDIC is similar to the lender of last resort function of a central bank. If the public believes that deposits will be honored (either through lending from a central bank or from deposit insurance), then depositors ought to have no incentive to run on their institution. In practice, it was not until the institution of deposit insurance in 1933 that the bank runs and panics that plagued the American economy for much of its history ceased to occur with regularity. Indeed, there were really no banking panics in the United States from the institution of deposit insurance until the financial crisis and Great Recession. As we will discuss more in [Chapter 36](#), the Great Recession featured a banking panic, but it was different than past panics. Individuals did not run on deposits, and commercial banks did not fail. Rather, institutions “ran” on other institutions in the sense that short term credit was not rolled over, forcing massive liquidations of assets and a general financial panic. Because this “run” occurred outside of the conventional banking system, the tools that had been developed to deal with runs were not immediately applicable.

32.5 Summary

- A primary objective of banks is liquidity transformation whereby the pooling of deposits from many different individuals can finance illiquid projects while at the same time give the depositors access to their deposits on demand.
- While the process of liquidity transformation is typically beneficial for the economy,

banks can be susceptible to runs. A run occurs if enough depositors think that the bank will not be able to meet their demand for future withdrawals. This causes all the depositors to withdraw in the present. Since a large portion of the bank's assets are tied up in illiquid projects, it may not be able to satisfy all the withdrawal demand. This further increases demand for withdrawals in the present creating a self-fulfilling prophecy.

- Banks have historically implemented a number of policies to reduce the probability of a bank run including suspending convertibility and withholding information. Suspending convertibility involved many banks joining together in refusing to meet withdrawal demand. Banks would also join together and withhold information about their balance sheet. The idea was that by withholding information this would stop depositors from running on any one bank. Otherwise healthy banks had an incentive to do this because a fire sale from an unhealthy bank would depress the value of assets.
- Government policy has also played a role in mitigating bank runs. By standing as the lender of last resort, the Federal Reserve gives banks a place to borrow without having to quickly sell its illiquid assets. The FDIC gives banks an opportunity to insure individual deposits up to \$250,000. Depositors are less likely to run on the bank if their deposits are insured.

Questions for Review

1. Suppose there exists an investment project that has a positive expected return. Would a household always find it optimal to invest in such a project?
2. How might deposit insurance create moral hazard?
3. We usually think that having complete information about a product or service is superior to having incomplete information. Describe the extent to which this is true in the financial intermediation industry.
4. Are bank runs irrational?

Chapter 33

Bond Pricing and the Risk and Term Structures of Interest Rates

A bond is a type of financial security which entitles the holder to periodic cash flows until maturity. With one exception discussed below, bonds have a finite life span after which they are retired – this finite life span is known as the maturity date. Bonds are often called *fixed income* securities because, outside of default, the cash flows accruing to the owner of the bond are known at the time of purchase. Default is a situation in which the bond issuer (i.e. the borrower) fails to make good on promised repayment, either in whole or in part. While bonds promise fixed income streams to the holder, they are not without risk. Risk arises for two reasons – first, because of the possibility of default, and second, because of unexpected price fluctuations (what is sometimes called interest rate risk). If a bondholder needs to sell his or her bond before its maturity date, he or she may do so at a price that entails a lower or higher return than what the bondholder expected. Governments and corporations are the chief issuers of bonds. They issue bonds to raise funds to finance either current expenditures or long term investments.¹ There is an active secondary market for bonds – one can buy an already issued bond from another individual or institution, which then entitles the new owner to any future cash flows coming from the bond.

The other main type of financial security is a *stock* or *equity*, which is the subject of Chapter 34. Both stocks and bonds are ways for corporations to raise funds to finance operations. Whereas bonds typically have finite life spans, equities are infinitely-lived. Unlike bonds, equities do not promise fixed cash flows. Dividends are the periodic cash flows returned to equity holders, but dividends are not known in advance and depend upon how profits evolve. Bond and stockholders have different seniority in the event of a corporation's failure.

¹A bond is a kind of debt instrument that is in many ways similar to a simple bank loan, and in fact the terms loan and bond are often used interchangeably (including in this very book). There are some subtle differences between bank loans and bonds in practice, however. First, because of asymmetric information, only very well-established firms can raise funds through issuing bonds, whereas smaller and less-established entities typically must rely on bank loans. Second, bank loans often include far more restrictive covenants and restrictions on the borrower uses of funds than do bonds. Third, while it is possible to trade bank loans in secondary markets, the markets for such loans are less liquid than the market for government and corporate bonds.

Stockholders are *residual claimants* who are entitled to their share of a company's assets only *after* all creditors, including bond holders, have been paid. Both because of unpredictability in dividends as well as less seniority in the event of a firm failure, stocks are considered riskier than bonds.

Bonds differ along several dimensions. First, they differ according to specifics of cash flow repayments. For example, some bonds make periodic monthly or quarterly cash payments to bond holders, whereas other bonds only offer one cash payment upon maturity to the bondholder. Second, bonds differ according to *default risk* – the probabilities that bond issuers will fail to make good on promised repayment naturally differ according to the financial health of the issuer. Government bonds in well-established countries are considered to be (essentially) default risk-free – that is, there is virtually no chance that the government will fail to make good on promised repayments. Third, bonds differ according to their life span, or *time to maturity*. For example, the US government issues both very short maturity debt (known as Treasury *bills*), medium term securities known as Treasury *notes*, and long maturity securities known as Treasury *bonds*. In spite of these different terms, we will refer to all three types of securities as “bonds.”

In this chapter we will first discuss the main type of cash flow repayment plans offered by bonds. Then we will discuss how to infer the interest rate on a bond in terms of the market price of the bond and the promised cash flows. This interest rate will be referred to as the yield to maturity (or just the “yield” for short). Yields can differ on bonds with similar cash flow repayment plans if these bonds have different default risk or time to maturities. How yields differ according to default risk is called the “risk structure” of interest rates and how yields differ according to time to maturity is called the “term structure” of interest rates. After discussing some specifics of bond cash flows and the concept of yield to maturity, we use a micro-founded general equilibrium approach to price bonds with different characteristics so as to discuss the risk and term structure of interest rates.

33.1 Bond Cash Flow Repayment Plans

The simplest type of bond is a discount bond. A discount bond is issued at date t with a face value, FV , and a maturity date, $t + m$. The holder of a discount bond receives one cash flow payment equal to the face value on the maturity date; there are no other promised cash flows between the date of issuance and the maturity date. Discount bonds typically sell for a *discount* relative to face value (face value is also sometimes called par value). For example, you might pay \$90 for a \$100 face value discount bond with time to maturity of 1 year. The difference between the buy price, in this case \$90, and the face value amounts to

interest earned on holding the bond. Examples of discount bonds in the real world include US Treasury Bills and commercial paper (a type of short term debt instrument issued by large corporations).

The other main type of bond is a coupon bond. Like a discount bond, a coupon bond is issued at date t with a face value and a maturity date. Differently than a discount bond, a coupon bond makes regular (monthly or quarterly) cash payments to the holder of the bond at intervals between the issue date and the maturity date. Like a discount bond, the face value is returned to the bond holder at the maturity date. Let CO be the coupon payment, and $co = \frac{CO}{FV}$ is defined as the coupon rate (defined as the (annual) coupon payment divided by the face value). The coupon rate is often referred to as an interest rate, though as we shall see this is not quite right. The implicit interest on a coupon bond depends both on the coupon rate as well as how much of a discount (or not) the bond trades at relative to face or par value. Examples of coupon bonds include Treasury bonds and corporate bonds.

A third type of bond is what is called a *perpetuity* (sometimes also a *consol* as this the name of these bonds issued in Great Britain). Perpetuities have no maturity date and hence no face value. They simply promise the holder of the bond a fixed coupon payment at regular intervals. Hence, the holder of a perpetuity is entitled to known and regular coupon payments for long as that holder maintains possession of the bond.

33.1.1 Yield to Maturity

The interest rate on a bond is rarely if ever explicit (although it is fairly common to confuse coupon rates on coupon paying bonds with the interest rate on the bond). Rather, the interest rate on a bond is *implicitly* defined given a market price of the bond and cash flow details about the bond.

The most common measure of the interest rate on a bond is the [yield to maturity](#) (or YTM or just yield for short). The YTM is defined as the (constant) discount rate which equates the price of the bond with the expected present discounted value of cash flows coming from ownership of the bond. The YTM represents the expected rate of return a holder of a bond would earn by holding that bond until maturity. We will refer to the YTM both as the interest rate on a bond as well as the “yield.” It is worth noting that the *realized* return on holding a bond need not equal the yield on the bond – if the bond price goes up or down in the future and the holder must sell the bond, then the realized return may differ from the yield.

Given a price of the bond (which we will discuss below) and cash flow details, we can determine the yield to maturity by equating the bond price with the present discounted value

of expected future cash flows. This will be easiest to see with examples based on the different kinds of cash payout streams discussed above. For simplicity, we assume in this section that there is no default risk, and hence no uncertainty about the cash flows accruing to the holder of a bond over that bond's lifespan.

First, consider a one period discount bond. The bond is sold in period t at price P_t^B .² It promises the face value, FV , to the holder the next period. The yield to maturity, or what we will label as r_t ,³ is implicitly defined by:

$$P_t^B = \frac{1}{1 + r_t} FV \quad (33.1)$$

In other words, the yield to maturity is simply the discount rate which equates the price of the bond to the future cash flows from the bond. For a one period discount bond, it is simply:

$$1 + r_t = \frac{FV}{P_t^B} \quad (33.2)$$

Provided the bond trades at less than face value, i.e. $P_t^B < FV$, the yield to maturity is positive. This is why most discount bonds do indeed trade at a discount relative to face – the holder of the bond requires a positive expected return (i.e. the yield) to hold the bond. The bigger is the gap between the price and the face value, the bigger is the implied yield.

Next, consider a discount bond with a greater than one period time to maturity. Denote this maturity by m . The yield to maturity on this bond satisfies:

$$P_t^B = \frac{1}{(1 + r_t)^m} FV \quad (33.3)$$

Since the face value on the bond is not received for m periods, it gets discounted by $(1 + r_t)^m$. This implicitly accounts for compounding. Given a price of the bond, the yield to maturity can be solved for as:

$$1 + r_t = \left(\frac{FV}{P_t^B} \right)^{\frac{1}{m}} \quad (33.4)$$

Note that (33.2) is just a special case of (33.4) when $m = 1$. Also note that the price of the bond and its implied yield are *negatively related*. This is an important point in bond

²Here and throughout the remainder of the chapter we use P_t^B to refer to the price of a bond (hence the B superscript). This superscript is included so as to not confuse the bond price with the money price of goods, P_t in earlier notation.

³We are using the same notation as the *real* interest rate from other parts of the book, though of course in practice what one directly can observe in the data are *nominal* yields. For what follows in this section, we abstract from risk arising from unexpected inflation movements and hence simply treat everything as real.

pricing – prices and yields move opposite one another.

Consider next a coupon bond. A coupon bond makes coupon payments of CO each period until maturity when it returns the face value to the holder. Taking the price as given, the yield to maturity on the coupon bond satisfies the following expression:

$$P_t^B = \frac{CO}{1+r_t} + \frac{CO}{(1+r_t)^2} + \frac{CO}{(1+r_t)^3} + \dots + \frac{CO}{(1+r_t)^m} + \frac{FV}{(1+r_t)^m} \quad (33.5)$$

This can be written more compactly using summation operators as:

$$P_t^B = \frac{CO}{1+r_t} \sum_{j=0}^{m-1} \frac{1}{(1+r_t)^j} + \frac{FV}{(1+r_t)^m} \quad (33.6)$$

The summation in (33.6) can be written:

$$S = \sum_{j=0}^{m-1} \frac{1}{(1+r_t)^j} = 1 + \frac{1}{1+r_t} + \left(\frac{1}{1+r_t}\right)^2 + \dots + \left(\frac{1}{1+r_t}\right)^{m-1} \quad (33.7)$$

So as to economize on notation, define $\gamma = \frac{1}{1+r_t}$. (33.7) can be written:

$$S = 1 + \gamma + \gamma^2 + \dots + \gamma^{m-1} \quad (33.8)$$

Then:

$$\gamma S = \gamma + \gamma^2 + \dots + \gamma^m \quad (33.9)$$

Which means:

$$S - \gamma S = 1 - \gamma^m \quad (33.10)$$

Now solve for S in terms of γ :

$$S = \frac{1 - \gamma^m}{1 - \gamma} = \frac{1 + r_t}{r_t} \left(1 - \left(\frac{1}{1 + r_t} \right)^m \right) \quad (33.11)$$

Which means (33.6) can be written:

$$P_t^B = \frac{CO}{r_t} \left(1 - \left(\frac{1}{1 + r_t} \right)^m \right) + \frac{FV}{(1 + r_t)^m} \quad (33.12)$$

(33.12) can equivalently be written:

$$P_t^B = \frac{CO}{FV r_t} \left(FV r_t - \frac{FV}{(1 + r_t)^m} \right) + \frac{FV}{(1 + r_t)^m} \quad (33.13)$$

As noted above, let $co = CO/FV$ be the coupon rate. Then we can write (33.13) as:

$$P_t^B = \frac{co}{r_t} FV + \frac{FV}{(1+r_t)^m} \left(1 - \frac{co}{r_t}\right) \quad (33.14)$$

From (33.14), one observes that if $P_t^B = FV$, then it must be the case that $co = r_t$ – i.e. the yield and the coupon rate are equal. Conversely, if the price of the bond is above par (i.e. $P_t^B > FV$), it must be that the yield is less than the coupon rate and vice-versa. This illustrates nicely that “the” interest rate on a bond is not necessarily the coupon rate on the bond.

Finally, we examine the relationship between the price and implied yield on a perpetuity. Given a price and coupon payment, the yield on a perpetuity must satisfy:

$$P_t^B = \frac{CO}{1+r_t} \sum_{j=0}^{\infty} \frac{1}{(1+r_t)^j} \quad (33.15)$$

The term inside the summation operator in (33.15) reduces to $\frac{1+r_t}{r_t}$ (to see this, simply let $m \rightarrow \infty$ in (33.12)). Then the yield on a perpetuity is given by:

$$r_t = \frac{CO}{P_t^B} \quad (33.16)$$

It is relatively easy to work with discount bonds, and for the remainder of the chapter we will do so. It turns out that a coupon bond can simply be thought of as a portfolio of discount bonds with different face values and maturities. For example, suppose that there is a bond paying a regular coupon payment of CO , with face value of FV , and two periods to maturity. Its yield to maturity is implicitly defined by:

$$P_t^B = \frac{CO}{1+r_t} + \frac{CO}{(1+r_t)^2} + \frac{FV}{(1+r_t)^2} \quad (33.17)$$

We could write (33.17) as the sum of the prices of two different discount bonds:

$$P_t = P_{1,t}^B + P_{2,t}^B \quad (33.18)$$

In (33.18), $P_{1,t}$ is the price of a one period discount bond with face value of CO and $P_{2,t}$ is the price of a two period discount bond with face value of $CO + FV$. For a perpetuity, we can think about it as the sum of discount bonds with face values of the coupon payment going off into the infinite future.

For all three types of cash flow repayment systems considered – (33.4), (33.14), and (33.16) we observe the general point that the price and yield on a bond are *inversely related*. Secondly, the yield is simply another way to express the price. The reason bond prices are

typically expressed in terms of yields and not prices is that it makes it easier to compare bonds with different maturities or cash flow characteristics. For example, a bond with a face value of \$10,000 will almost certainly trade for a higher price than a bond with a face value of \$1,000. But this doesn't necessarily mean that the \$10,000 bond will provide a better expected return if held to maturity. Similarly, a discount bond with a longer time to maturity will generally trade at a lower price than a discount bond with a shorter maturity. Again, this does not necessarily mean that the longer maturity bond will offer a higher expected return. Expressing bond prices in terms of yields puts bonds with different face values and maturities on a "level playing field" that makes it easier to compare them.

But even if we compare bonds in terms of yields, which eliminates potential issues arising from different face values or times to maturity, the yields on two different bonds are unlikely to be the same at any point in time. The question is how and why yields might differ. In the next section, we introduce a micro-founded approach to determining bond prices and thereby inferring yields. We do so in a dynamic consumption-saving environment where in equilibrium consumption must equal an exogenous endowment of income. We then extend the analysis to allow for uncertainty, which allows us to discuss both the risk and term structures of interest rates.

33.2 Bond Pricing with No Uncertainty: A General Equilibrium Approach

We have to this point defined bonds, discussed repayment schemes on different kinds of bonds, and introduced the concept of the yield to maturity as a measure of the interest rate on a bond. In finding the yield, we took the price of the bond as given, and noted that bond prices and yields move opposite one another. But how does the price of the bond (and hence its yield) get determined?

We will explore bond pricing within an optimizing, dynamic framework. We will focus on a representative agent model with as few periods as possible (for the most part this will be the two period framework used throughout the book, but when studying the term structure of interest rates, we will have to move beyond two periods). Since we want to focus on the determination of prices, which are an equilibrium construct, we need to work in the confines of a model with general equilibrium. We will do so using the simplest possible framework – the endowment economy framework studied in Chapter 11. We will focus on purely real frameworks in which we abstract from money and nominal prices.

We will make three additional assumptions meant to simplify the analysis. First, we will assume that all bonds are discount bonds. This obviously abstracts from the multitude of

repayment plans that bonds offer, but it simplifies the analysis and no important insights are lost because a coupon-paying bond can always be thought of as a portfolio of discount bonds. Second, we will assume, except where noted, that all bonds are in fixed supply, and in particular for the most part *in zero net supply*. This follows the important work of [Lucas \(1978\)](#). In this environment, in equilibrium the representative household does not actually hold any bonds (i.e. as in our endowment economy model, in equilibrium it is not possible for the household to save or borrow). Bond prices (equivalently yields) adjust so that in equilibrium the household is content not borrowing or saving. Allowing for bonds to be in non-zero net supply would not fundamentally alter any of the conclusions to follow but would make the analysis more complicated. Third, for now we shall assume that there is no uncertainty over the future. Uncertainty could arise because of uncertainty in bond repayments (i.e. default) or in income/endowment uncertainty. We will address both types of uncertainty later.

Suppose that a representative household lives for two periods, t and $t + 1$. It has the following lifetime utility:

$$U = u(C_t) + \beta u(C_{t+1}) \tag{33.19}$$

The household begins life with no assets (and in this framework the only possible asset is a bond). In period t , the household earns some exogenous stream of income, Y_t . With this income it can consume or save/borrow through a discount bond, B_t . One unit of the discount bond held from t to $t + 1$ yields one unit of income in $t + 1$. The discount bond trades for a price of P_t^B in period t . The household takes this price as given. The household's period t budget constraint is:

$$C_t + P_t^B B_t \leq Y_t \tag{33.20}$$

In period $t + 1$, the household earns an exogenous income stream and receives income from its holdings of bonds. In principle, it could accumulate additional bonds (or borrow through additional bonds), but we will go ahead and impose the terminal condition that the household cannot die with a non-zero stock of assets. Hence, its period $t + 1$ budget constraint is:

$$C_{t+1} \leq Y_{t+1} + B_t \tag{33.21}$$

The household's objective is to maximize (33.19) subject to (33.20)-(33.21). We could form a unified intertemporal budget constraint as we did earlier in the course, and think about the household as choosing a consumption plan, C_t and C_{t+1} . Because it is more closely

aligned with the approach we will take later, we will instead think about the problem as one of simply choosing B_t in period t . Assuming that both constraints hold with equality, plugging in so as to eliminate C_t and C_{t+1} yields an unconstrained problem:

$$\max_{B_t} U = u(Y_t - P_t^B B_t) + \beta u(Y_{t+1} + B_t) \quad (33.22)$$

The first order optimality condition is:

$$\frac{\partial U}{\partial B_t} = 0 \Leftrightarrow P_t^B u'(C_t) = \beta u'(C_{t+1}) \quad (33.23)$$

In taking the derivative, we have taken the liberty of noting that the argument of the utility function is simply C_t or C_{t+1} . (33.23) is an optimality condition that must hold if the household is behaving optimally. The intuition for this condition is straightforward. Purchasing one unit of the bond in period t requires foregoing P_t^B units of income in that period. In terms of utility, this income is valued at $u'(C_t)$. Hence, $P_t^B u'(C_t)$ represents the marginal utility cost of holding one additional unit of the discount bond. What is the benefit of holding an additional unit of the bond? The benefit is increasing period $t + 1$ consumption by 1, which is valued in terms of lifetime utility at $\beta u'(C_{t+1})$. Hence, $\beta u'(C_{t+1})$ represents the marginal utility benefit of purchasing this bond. At an optimum, the marginal utility benefit must equal the marginal utility cost if the household is behaving optimally.

(33.23) can equivalently be written:

$$P_t^B = \frac{\beta u'(C_{t+1})}{u'(C_t)} \quad (33.24)$$

The right hand side of (33.24) is an important concept in macroeconomics and finance known as the *stochastic discount factor*. The stochastic discount factor is simply the inverse marginal rate of substitution between current and future consumption. In any micro-founded model of asset pricing, the price of an asset ought to satisfy:

$$P_{a,t} = \mathbb{E} \left[\frac{\beta u'(C_{t+1})}{u'(C_t)} \times D_{a,t+1} \right] \quad (33.25)$$

In (33.25) we allow for uncertainty (either over future consumption or future cash flows from the asset or both), and hence the \mathbb{E} operator appears on the right hand side. The subscript a indexes an asset and $D_{a,t+1}$ is the cash flow generated by the asset in the subsequent period. (33.25) says that the price of an asset ought to equal the expected value of the product of the stochastic discount factor with the payout generated by the asset in the future. (33.24) is simply a special case of this, because (i) the payout of the risk-free bond is 1, so $D_{a,t+1} = 1$, and (ii) we have assumed no uncertainty of any sort, so we can drop the

expectations operator. As we shall see, the basic pricing formula for risky debt and for stocks (see Chapter 34) will take the same general form of (33.25).

Let us return to our particular example of a risk-free one period discount bond with no income uncertainty. On its own, (33.24) does not determine P_t because it is written as a function of endogenous variables, C_t and C_{t+1} . To determine P_t , we need some notion of what it means for markets to clear. As noted above, we are going to consider endowment economies in which bonds are in zero net supply. This means that, in equilibrium, $B_t = 0$, which requires that $C_t = Y_t$ and $C_{t+1} = Y_{t+1}$, where Y_t and Y_{t+1} are taken to be exogenous. This means that the equilibrium bond price is:

$$P_t^B = \frac{\beta u'(Y_{t+1})}{u'(Y_t)} \quad (33.26)$$

With log utility, for example, (33.26) would become:

$$P_t^B = \beta \frac{Y_t}{Y_{t+1}} \quad (33.27)$$

The equilibrium bond price is *inversely* related to expected growth of the endowment. The intuition for this is straightforward and related to intuition discussed in Chapter 11. When Y_t increases relative to Y_{t+1} , other things being equal the household would like to save so as to transfer resources from the present (when resources are plentiful) to the future (when resources are comparatively scarce). This amounts to an increase in the demand for the bond. In equilibrium, it is not possible for the household to hold more of the bond, so the price of the bond must rise to keep the household content not holding any of the bond. The intuition for this can be seen in a simple demand-supply diagram below. An increase in the current endowment makes the household want to save more, and so there is an increase in demand for the bond. With a fixed supply of the bond, this necessitates an increase in the price of the bond.

Figure 33.1: Increase in Current Enowment

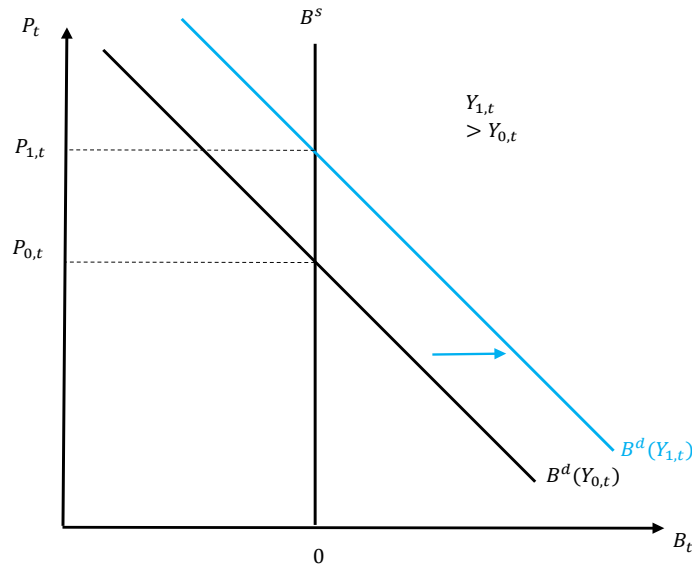

Conversely, suppose that the household anticipates an increase in Y_{t+1} relative to Y_t . Other things being equal, the household would like to borrow (or reduce its saving) so as to smooth its consumption. In other words, there is reduced demand for the bond. But in equilibrium, the household cannot borrow, so the price of the bond must fall. This is shown in the simple demand-supply diagram below.

Figure 33.2: Increase in Future Endowment

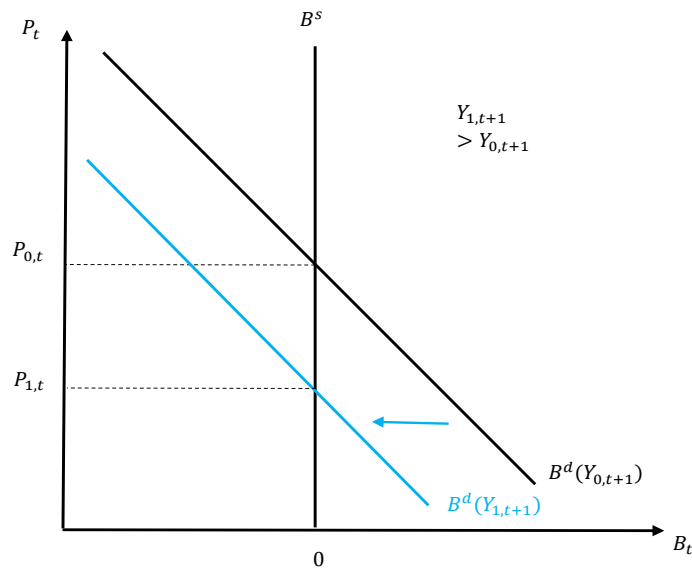

Once we know the bond price, we can determine the implied yield to maturity. Recall

that the yield to maturity is the discount rate which equates the bond price with the present discounted value of expected future cash flows from the bond. There is no uncertainty here, and the bond yields 1 unit of income in period $t + 1$. Hence, the yield must satisfy:

$$P_t^B = \frac{1}{1 + r_t} \quad (33.28)$$

Plugging in the expression for the equilibrium bond price, (33.29), we get:

$$1 + r_t = \frac{u'(Y_t)}{\beta u'(Y_{t+1})} \quad (33.29)$$

With log utility, for example, (33.29) becomes:

$$1 + r_t = \frac{Y_{t+1}}{\beta Y_t} \quad (33.30)$$

One will note that this expression for the equilibrium bond yield is *exactly* the same expression we derived for the equilibrium interest rate for an endowment economy with log utility in Chapter 11. In equilibrium, the bond yield / interest rate is a measure of the expected plentifulness of the future relative to the present. In that chapter, we talked about a *supply* of saving being increasing in r_t . In this chapter, we are thinking about a *demand* for bonds that is decreasing in the price of the bond, P_t . Even though we are switching from “supply” to “demand,” in either case we are conveying exactly the same information and intuition. Bond prices / yields adjust to prevent the household from smoothing its consumption relative to its income.

33.3 Default Risk and the Risk Structure of Interest Rates

In the previous section we used an optimizing dynamic model to discuss how the price of a bond is determined in general equilibrium. We did so in an environment with no uncertainty. We now modify the setup so that the future is uncertain, which allows us to study the risk structure of interest rates.

The risk structure of interest rates refers to how bond prices (equivalently interest rates) vary according to the risk that the future cash flows from the bond will differ from what has been promised. To discuss the risk structure, we need to (i) allow for uncertainty, potentially both in the household’s endowment stream as well as in payouts from the bond, and (ii) allow for different types of bonds with potentially different risk.

Suppose that there is a representative household who lives for two periods. The household receives an exogenous income stream in period t and a potentially uncertain exogenous income stream in $t + 1$. In period t , the household can save through different discount bonds. One of

these is risk-free and we will denote it with an rf subscript. Let $B_{rf,t}$ denote the quantity of the risk-free bond the household purchases to take from t to $t + 1$ at price $P_{rf,t}^B$. The bond is risk-free in the sense that one unit purchased in period t yields one unit of income in period $t + 1$ *with certainty*. We can think of the risk-free bond as a government-issued bond – there is essentially no risk of the government defaulting on repayment.

In addition, the household has access to a risky discount bond. The quantity the household takes from t to $t + 1$ is denoted $B_{r,t}$ and the household pays a price of $P_{r,t}^B$ for this bond. This bond is risky in the sense that there is potentially a probability that the bond *defaults*, which means it generates *no income* in period $t + 1$.⁴

In period t , household consumption plus purchases of both the risk-free and risky bond cannot exceed an exogenous endowment of income:

$$C_t + P_{rf,t}^B B_{rf,t} + P_{r,t}^B B_{r,t} \leq Y_t \quad (33.31)$$

To think about the budget constraint in $t + 1$, we need to describe the nature of uncertainty over what happens in period $t + 1$. Suppose that income in period $t + 1$ can take on two different values, high and low – $Y_{t+1}^h \geq Y_{t+1}^l$. Furthermore, the risky bond can make two different payouts – no default (payout of 1) or default (payout of 0). This means that there are four different possible “states of the world” in $t + 1$. These states are summarized below:

- State 1: $Y_{t+1} = Y_{t+1}^h$, risky bond pays
- State 2: $Y_{t+1} = Y_{t+1}^h$, risky bond defaults
- State 3: $Y_{t+1} = Y_{t+1}^l$, risky bond pays
- State 4: $Y_{t+1} = Y_{t+1}^l$, risky bond defaults

Let the probabilities of these states occurring be denoted p_1, p_2, p_3 , and $p_4 = 1 - p_1 - p_2 - p_3$ (i.e. the probabilities must sum to one since one of the four states must occur). A flow budget constraint must hold in period $t + 1$ in all four states of the world. Letting $C_{t+1}(j)$, $j = 1, \dots, 4$, denote consumption in each state of the world, and going ahead and imposing that the constraint must hold with equality, we must have:

⁴One could also entertain *partial* default, wherein the bond would generate somewhere between 0 and 1 units of income period $t + 1$.

$$C_{t+1}(1) = Y_{t+1}^h + B_{rf,t} + B_{r,t} \quad (33.32)$$

$$C_{t+1}(2) = Y_{t+1}^h + B_{rf,t} \quad (33.33)$$

$$C_{t+1}(3) = Y_{t+1}^l + B_{rf,t} + B_{r,t} \quad (33.34)$$

$$C_{t+1}(4) = Y_{t+1}^l + B_{rf,t} \quad (33.35)$$

Regardless of the realized state of the world, consumption must equal available resources since the household wishes to die with no assets. In (33.32)-(33.35), the risk-free bond always generates one unit of income, while the risky bond only generates income in states 1 and 3. The household's expected lifetime utility is simply a discounted probability-weighted sum of flow utilities across time and states of the world:

$$U = u(C_t) + \beta [p_1 u(C_{t+1}(1)) + p_2 u(C_{t+1}(2)) + p_3 u(C_{t+1}(3)) + (1 - p_1 - p_2 - p_3) u(C_{t+1}(4))] \quad (33.36)$$

(33.36) can equivalently be written in terms of the expected utility of future consumption, since $\mathbb{E}[u(C_{t+1})] = p_1 u(C_{t+1}(1)) + p_2 u(C_{t+1}(2)) + p_3 u(C_{t+1}(3)) + (1 - p_1 - p_2) u(C_{t+1}(4))$:

$$U = u(C_t) + \beta \mathbb{E}[u(C_{t+1})] \quad (33.37)$$

The household's objective is pick a consumption plan to maximize (33.36) subject to (33.31)-(33.35). It will be easiest to re-cast the problem not as one of choosing a consumption plan but rather bond holdings in period t . Doing so yields the following unconstrained maximization problem:

$$\begin{aligned} \max_{B_{rf,t}, B_{r,t}} \quad U = & u[Y_t - P_{rf,t}^B B_{rf,t} - P_{r,t}^B B_{r,t}] + \beta p_1 u[Y_{t+1}^h + B_{rf,t} + B_{r,t}] + \\ & \beta p_2 u[Y_{t+1}^h + B_{rf,t}] + \beta p_3 u[Y_{t+1}^l + B_{rf,t} + B_{r,t}] + \beta (1 - p_1 - p_2 - p_3) u[Y_{t+1}^l + B_{rf,t}] \end{aligned} \quad (33.38)$$

The first order conditions are:

$$\begin{aligned} \frac{\partial U}{\partial B_{rf,t}} = 0 \Leftrightarrow P_{rf,t}^B u'(C_t) = \\ \beta [p_1 u'(C_{t+1}(1)) + p_2 u'(C_{t+1}(2)) + p_3 u'(C_{t+1}(3)) + (1 - p_1 - p_2 - p_3) u'(C_{t+1}(4))] \end{aligned} \quad (33.39)$$

$$\frac{\partial U}{\partial B_{r,t}} = 0 \Leftrightarrow P_{r,t}^B u'(C_t) = \beta p_1 u'(C_{t+1}(1)) + \beta p_3 u'(C_{t+1}(3)) \quad (33.40)$$

In writing these first order conditions, we have taken the (simplifying) liberty of writing the arguments of the utility function simply as consumption values at different dates and states. In an endowment economy equilibrium, no bonds are held and consumption simply equals income. This means that (33.39)-(33.40), combined with this market-clearing condition, determine the equilibrium prices of the two bonds:

$$P_{rf,t}^B = \beta \frac{p_1 u'(Y_{t+1}^h) + p_2 u'(Y_{t+1}^h) + p_3 u'(Y_{t+1}^l) + (1 - p_1 - p_2 - p_3) u'(Y_{t+1}^l)}{u'(Y_t)} \quad (33.41)$$

$$P_{r,t}^B = \beta \frac{p_1 u'(Y_{t+1}^h) + p_3 u'(Y_{t+1}^l)}{u'(Y_t)} \quad (33.42)$$

Note that both (33.41) and (33.42) can be re-written in terms of expectations operators as:

$$P_{rf,t}^B = \beta \frac{\mathbb{E}[u'(Y_{t+1})]}{u'(Y_t)} = \mathbb{E} \left[\frac{\beta u'(Y_{t+1})}{u'(Y_t)} \right] \quad (33.43)$$

$$P_{r,t}^B = \beta \frac{\mathbb{E}[u'(Y_{t+1}) D_{t+1}]}{u'(Y_t)} = \mathbb{E} \left[\frac{\beta u'(Y_{t+1}) D_{t+1}}{u'(Y_t)} \right] \quad (33.44)$$

In (33.44), D_{t+1} is the payout on the risky bond (either 1 or 0). In both (33.43) and (33.44), the second equal signs follows because β and $u'(Y_t)$ are known at the time the expectation is made, so the pricing conditions can be written either with these inside or outside of the expectations operator. With these terms written inside the expectations operator, one observes that (33.43) and (33.44) are just special cases of (33.25). The price of either bond is the expected value of the product of the stochastic discount factor (evaluated at equilibrium levels of consumption $C_t = Y_t$ and $C_{t+1} = Y_{t+1}$) with the payout on the bond (1 in the case of the risk-free bond and $D_{t+1} = 1$ or 0 in the case of the risky debt).

We will define the *risk premium* as the difference between the yield on the risky bond and the yield on the risk-free bond. The yield on each bond equates the price of the bond to the expected cash flows. For the risk-free bond, the yield simply satisfies:

$$1 + r_{rf,t} = \frac{1}{P_{rf,t}^B} = \frac{u'(Y_t)}{\beta \mathbb{E}[u'(Y_{t+1})]} \quad (33.45)$$

For the risky bond, the yield is the ratio of the expected payout, $\mathbb{E}[D_{t+1}]$, to the price:

$$1 + r_{r,t} = \frac{\mathbb{E}[D_{t+1}]}{P_{r,t}^B} = \frac{\mathbb{E}[D_{t+1}]u'(Y_t)}{\beta \mathbb{E}[u'(Y_{t+1})D_{t+1}]} \quad (33.46)$$

The risk premium can be defined as (approximately) the ratio of the two gross yields minus one:

$$r_{r,t} - r_{f,t} \approx \frac{1 + r_{r,t}}{1 + r_{f,t}} - 1 = \frac{\mathbb{E}[D_{t+1}] \mathbb{E}[u'(Y_{t+1})]}{\mathbb{E}[u'(Y_{t+1})D_{t+1}]} - 1 \quad (33.47)$$

One would be tempted to look at (33.47) and distribute the expectations operator through the denominator, in which case the risk premium would be zero. In general, one cannot do this. As we shall see again and again in this and the next chapter, for two arbitrary random variables X and Y , $\mathbb{E}[XY] = \mathbb{E}[X]\mathbb{E}[Y] + \text{cov}(X, Y)$. This means we can write:

$$r_{r,t} - r_{f,t} = \frac{\mathbb{E}[u'(Y_{t+1})D_{t+1}] - \text{cov}(u'(Y_{t+1}), D_{t+1})}{\mathbb{E}[u'(Y_{t+1})D_{t+1}]} - 1 \quad (33.48)$$

Which means:

$$r_{r,t} - r_{f,t} = -\frac{\text{cov}(u'(Y_{t+1}), D_{t+1})}{\mathbb{E}[u'(Y_{t+1})D_{t+1}]} \quad (33.49)$$

In other words, the existence and sign of the risk premium depend on how the payouts from the risky bond co-vary with the marginal utility of future income. If the risky bond's payout covaries negatively with $u'(Y_{t+1})$, then a household will require a *higher* yield to be indifferent between holding that bond and the risk-free bond. The household wishes to hold assets to facilitate consumption smoothing. It therefore “likes” assets whose payouts covary positively with $u'(Y_{t+1})$ and “dislikes” assets whose payouts covary negatively with $u'(Y_{t+1})$. The reason why is straightforward – $u'(Y_{t+1})$ measures (in equilibrium) how much the household values extra income. The household “likes” assets that have a high payout precisely when extra income is most valuable (periods in which $u'(Y_{t+1})$ is high) and vice-versa. Note that given the assumption of diminishing marginal utility, $u'(Y_{t+1})$ will be high (low) when Y_{t+1} is low (high).

Let us now turn to some specific numerical examples to see these points clearly. Let us assume that the utility function is the natural log, that $\beta = 0.95$, that $Y_t = 1$, and that $Y_{t+1}^h = 1.1$ and $Y_{t+1}^l = 0.9$. In the subsections which follow, we will consider different values of p_1 , p_2 , and p_3 and how these influence the prices of each bond as well as the implied yields on each type of bond.

33.3.1 No Income Risk

First, consider a specification of uncertainty in which there is no income risk – future income is either high with probability 1 (so $p_1 + p_2 = 1$ and $p_3 = 0$), or low with probability 1 (so $p_1 = p_2 = 0$).

First, suppose that income is high with probability 1. This means that the price of the risk-free bond, (33.41), is:

$$P_{rf,t}^B = \beta \frac{Y_t}{Y_{t+1}^h} = 0.95 \times \frac{1}{1.1} = 0.8636 \quad (33.50)$$

The price of the risky bond, (33.42), can be written:

$$P_{r,t}^B = \beta p_1 \frac{Y_t}{Y_{t+1}^h} \quad (33.51)$$

To determine the price of the risky bond, we need to specify a value of p_1 , which works out to the probability that the bond does not default. If $p_1 = 0$, for example, the bond would have an equilibrium price of 0. This makes sense because the bond defaults in $t + 1$ with probability 1, and is therefore worthless. If $p_1 = 1$, in contrast, the price of the risky bond would be identical to the price of the risk-free bond. For intermediate values of p_1 , the price of the risky bond will be between 0 and the price of the risk-free bond. The relationship between p_1 and the price of each type of bond is shown below in Figure 33.3.

Figure 33.3: Bond Prices and p_1 : Income Always High

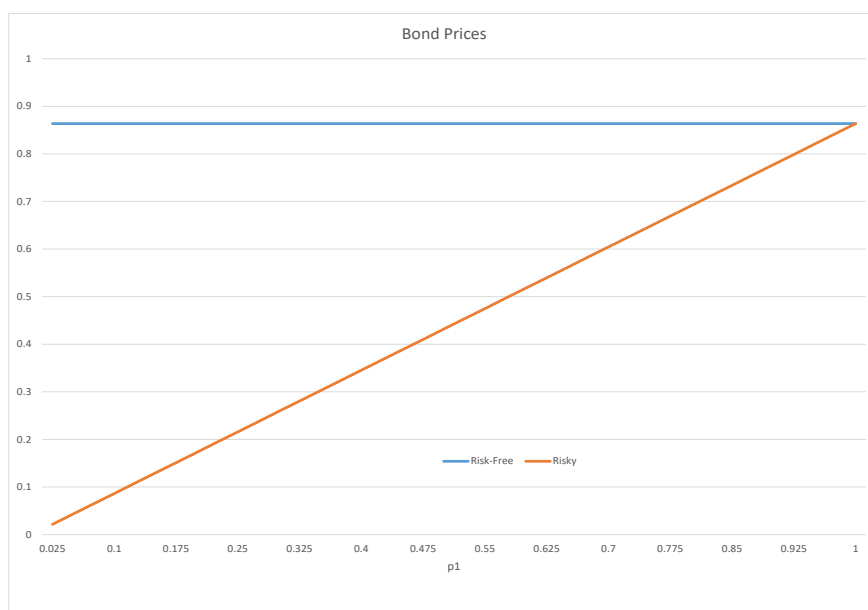

The yield to maturity on either bond is simply the ratio of the expected future cash flow

generated from the bond to the current bond price (since we are dealing with one period discount bonds). The (gross) yield on the risk-free bond works out to:

$$1 + r_{r,f,t} = \frac{Y_{t+1}^h}{\beta Y_t} = 1.1579 \quad (33.52)$$

In (33.52), the expected future cash flow from the bond is just 1, so the yield is simply the inverse of the bond price. The yield to maturity on the risky bond is conceptually the same. The expected cash flow from the bond is p_1 – with probability p_1 , the bond pays out one unit of income, and with probability p_2 the bond pays nothing. Hence, the yield to maturity on the risky bond is:

$$1 + r_{r,t} = p_1 \times \frac{Y_{t+1}^h}{p_1 \beta Y_t} = \frac{Y_{t+1}^h}{\beta Y_t} = 1.1579 \quad (33.53)$$

In other words, for this particular example, the yield on the risky bond is *exactly* the same as the yield on the risk-free bond, and there is consequently no risk premium. This is shown in Figure 33.4, which plots the yields on each kind of bond as well as the risk premium as a function of p_1 . There is no risk premium in spite of the fact that the bond itself *is* risky in the sense that there is a chance it might default (unless $p_1 = 0$ or $p_1 = 1$). The reason there is no risk premium is evident from (33.49). If there is no income risk, then there can be no covariance between the bond's payout and $u'(Y_{t+1})$, and hence no risk premium.

Figure 33.4: Yields and Risk Premium: Income Always High

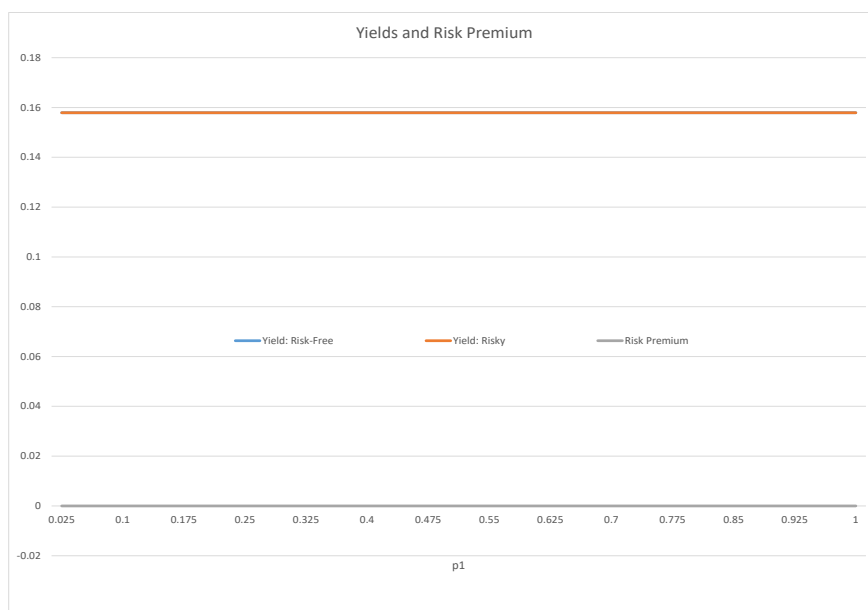

For completeness, we also consider the case where there is no uncertainty over future

income, but it is always low instead of always high. This means that $p_1 = p_2 = 0$. Figure 33.5 plots the prices of the risk-free and risky bonds as a function of p_3 (the probability the risky bond does not default).

Figure 33.5: Bond Prices and p_3 : Income Always Low

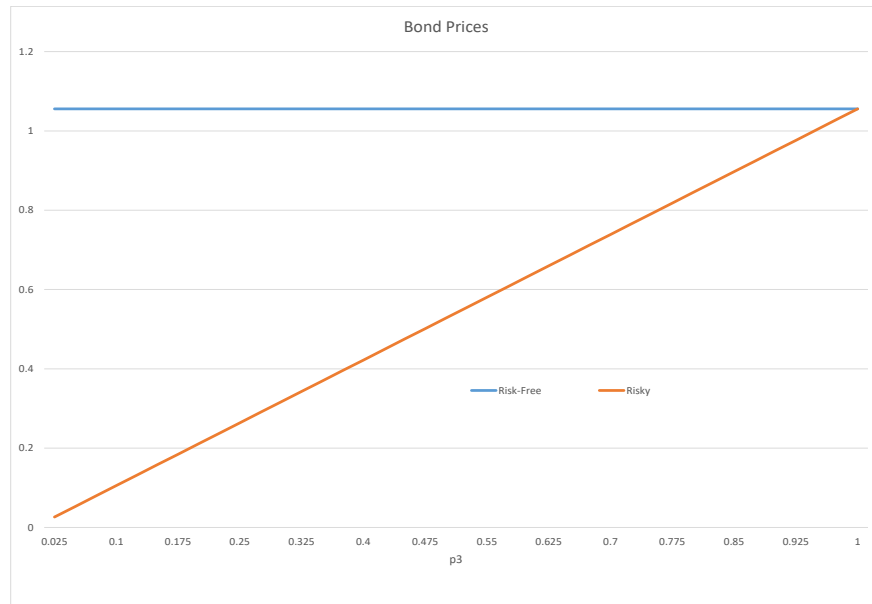
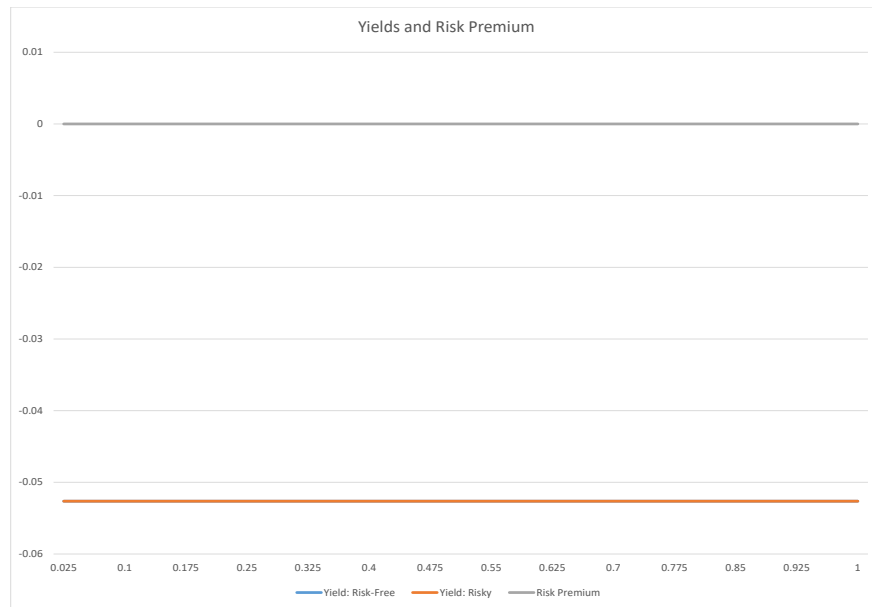

Figure 33.5 looks similar to Figure 33.3 in that the price of the risk-free bond is independent of p_3 and the price of the risky bond is increasing in p_3 . What is different however is that the price of the risk-free bond is substantially higher here than in Figure 33.3. The reason is that if the household *knows* it is going to have low income in the future, it wants to save today to try to smooth its consumption. This means there is high demand for the risk-free bond, which puts upward pressure on its price. Corresponding to upward pressure on its price, in Figure 33.6 we plot yields on both kinds of bond as well as the risk premium. Here we see that both bonds offer *negative* yields. There is nothing conceptually wrong with negative (real) yields – it simply means that there is sufficiently strong demand for the bond that market-clearing requires a negative yield. There is again no risk premium because there is no covariance between the bond’s payout and future income.

Figure 33.6: Yields and Risk Premium: Income Always Low



33.3.2 No Default Risk

Next, let us suppose that there is income risk but there is no risk of the risky bond defaulting. That is, the economy is always in states 1 or 3 – income could be high or low in $t + 1$, but the risky bond always pays off. This means that $p_1 + p_3 = 1$, with $p_2 = p_4 = 0$. Figure 33.7 plots the price of each bond as a function of p_1 (the probability of the good income state):

Figure 33.7: Bond Prices and p_1 : No Default Risk

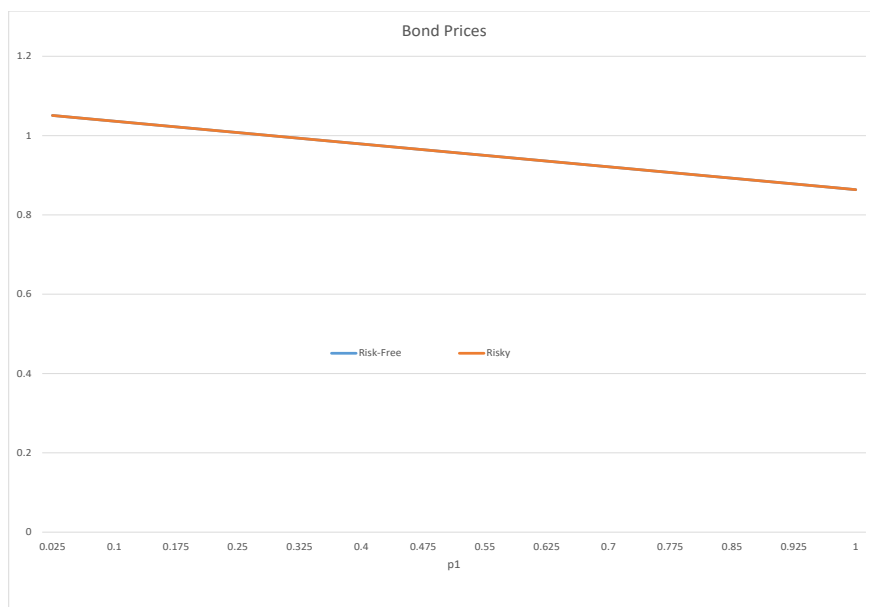

There are two important things to emerge from Figure 33.7. First, the prices of each type of bond are identical regardless of p_1 . The reason for this is that there is no real difference between the bonds if there is no default risk – they both pay one in $t + 1$. Second, the price of either type of bond is decreasing in p_1 . When p_1 is low, income in the future is expected to be low. The household would like to save to smooth consumption, so there is high demand for bonds and consequently a comparatively high price. In contrast, when p_1 is large, in expectation future income is high, so the household doesn't have much incentive to save. Consequently, there is not much demand for the bond and consequently the price of the bond is comparatively low.

Figure 33.8: Yields: No Default Risk

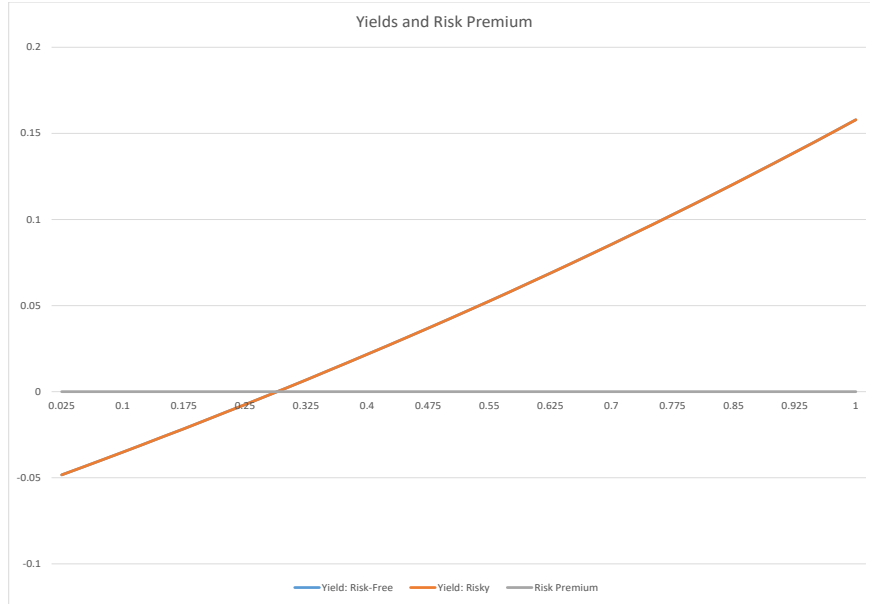

Figure 33.8 plots yields on each type of bond as a function of p_1 . Since the prices of each bond are always the same, the yields are always equal and hence there is no risk premium. The yields move in the opposite direction of the bond price. When p_1 is low, yields are low (even negative), because there is a strong incentive to save to prevent future consumption from being low and yields must be low (or even negative) to discourage this saving. The reverse is true when p_1 is large. There is no risk premium because there is no risk of default on the risky bond.

33.3.3 Income Risk and Default Risk

Above we considered two separate descriptions of uncertainty – one in which future income is certain and the risky bond is in fact risky, and another in which future income is unknown but there is no probability of default. In neither case do the yields on the risk-free and risky bond differ (even though their prices potentially do).

To get a risk premium, we must have *both* income and the risky bond’s payout be risky in the sense of being uncertain. But even this is not sufficient to generate a risk premium, as we shall see. To generate a positive risk premium, it must be the case that default is more likely in states in which income is low (and vice-versa).

Table 33.1 considers different values of p_1 , p_2 , p_3 , and p_4 . The examples are all constructed in which the expected value of future income is always one and the expected value of the risky bond’s payout is 0.5. We also show the expected risky bond payout *conditional* on income being high or low, i.e. $\mathbb{E}[D_{t+1} | Y_{t+1}^h]$ for the expectation conditional on high income

in the future. If the expected risky bond payout is higher than its unconditional payout when income is high, then the bond payout is positively correlated with income (and negatively correlated with the marginal utility of future income) and vice-versa.

The first row considers the case where these probabilities are all 0.25, so that each state is equally likely. In this case, future income is uncertain and the bond is risky, yet there is no risk premium. The reason why is that there is no difference between the conditional expectations of the bond payout and the unconditional expectations. Put differently, there is no correlation between the risky bond payout and income – the risky bond is equally likely to default when income is high as when income is low.

Table 33.1: The Nature of Uncertainty and Risk Premia

Probabilities	$\mathbb{E}(D)$	$\mathbb{E}(Y_{t+1})$	$\mathbb{E}(D_{t+1} Y_{t+1}^h)$	$\mathbb{E}(D_{t+1} Y_{t+1}^l)$	$r_{r,t} - r_{f,t}$
$p_1 = p_2 = p_3 = p_4 = 0.25$	0.5	1	0.5	0.5	0.00
$p_1 = 0.5, p_2 = p_3 = 0, p_4 = 0.5$	0.5	1	1	0	0.12
$p_1 = p_4 = 0, p_2 = p_3 = 0.5$	0.5	1	0	1	-0.09
$p_1 = 0.4, p_2 = 0.1, p_3 = 0.1, p_4 = 0.4$	0.5	1	0.8	0.2	0.07

The second row considers the case in which there is a 50 percent chance of high income and a 50 percent chance of low income, where the bond defaults with certainty when income is low and pays with certainty when income is high (i.e. $p_2 = p_3 = 0$). While somewhat extreme, this is a reasonable characterization of corporate debt – defaults are most likely when output is low and less likely when times are good. Here we observe a positive risk premium of 0.12 – the yield on the risky bond is substantially higher than the yield on the riskless bond. Intuitively, the reason why can be seen by looking at the conditional expectations. In the good income state, the payout on the bond is high, and in the bad income state, the payout on the bond is zero. A household does not like an asset with these characteristics – the household wants to smooth its consumption, so other things being equal it would prefer an asset whose payout is high when income is low (equivalently, high when extra income is most highly valued, i.e. when $u'(Y_{t+1})$ is high). In this setup, the risky bond does not have these characteristics. For market-clearing, the household cannot hold any of either the risky or the risk-free bond, and hence must be indifferent between them. For the household to be indifferent between the two types of bonds, the yield on the risky bond must be higher than the yield on the risk-free bond.

The third row considers the opposite case – income can be high or low, but the bond always defaults when income is high, and always pays face value when income is low. This results in a *negative* risk premium. The reason why the risk premium is negative is the mirror image of why we get a positive risk premium when the bond defaults when income is low.

The risky bond *helps* the household smooth its consumption by giving it income precisely in the periods where additional income is most valuable (i.e. periods in which income is otherwise low). Hence, the household *prefers* the risky bond to the risk-less bond, and the risky bond accordingly must offer a lower yield to make the household indifferent between the two types of debt.

The final row considers a case similar to the second row, but less extreme. There is again a 50-50 chance of income being high or low. The risky bond is *more* likely to default in the low income state, but there is some probability of it not defaulting even if income in $t + 1$ is low. This results in a positive risk premium but not as large as in the case considered in the second row.

The general pattern that emerges from Table 33.1 is that the risk premium depends positively on $\mathbb{E}(D_{t+1} | Y_{t+1}^h) - \mathbb{E}(D_{t+1} | Y_{t+1}^l)$. When this difference is positive, the bond is most likely to default in precisely the periods in which income is most dear to the household (and hence a default is most costly). To compensate the household for this risk, the risky bond must offer a comparatively high yield relative to the risk-free bond.

Figure 33.9 below plots a time series of a popular measure of the aggregate risk premium. In particular, we show the difference between the average yield on Baa-rated corporate debt and the yield on a 10 year Treasury note.

Figure 33.9: Yields: No Default Risk



The risk premium is positive for the entire sample, typically hovering in the range of 1 to 2 percent (annualized). If anything, the risk premium seems to have risen over time. Another

interesting pattern is that the risk premium is quite clearly countercyclical – i.e. it seems to rise during periods identified as recession (the shaded gray bars) and falls during expansions.

33.4 Time to Maturity and the Term Structure of Interest Rates

In the previous section we considered different kinds of bonds with potentially different probabilities of default. We showed that if a risky bond is more likely to default in a period in which output is low (so the marginal utility of consumption is high), then that bond must offer a higher yield than a risk-free bond to make the household indifferent between the two types of bonds.

Aside from default risk, the other principal dimension along which bonds differ is *time to maturity*. As noted above, the US government issues both short term (Treasury Bills), medium term (Treasury Notes), and long term (Treasury Bonds) debt securities. Similarly, corporations issue both short term (commercial paper) and longer term (corporate bond) securities. Holding the default risk fixed (i.e. comparing only risk-free government securities with different maturities, or risky corporate debt with different maturities but the same default probabilities), how, if at all, do yields vary with time to maturity? If they do vary with time to maturity, why do they vary? We refer to the study of how yields vary with time to maturity (holding default risk fixed) as the *term structure of interest rates*. What relevant macroeconomic information does the term structure convey? We study these questions in this section.

Before considering theory, let us start with some facts. Figure 33.10 plots yields across time on Treasury debt with both a 10 year maturity (Treasury Note) and a three month maturity (Treasury Bill). There are several things worth noting. First, yields have been steadily falling for the last three decades. Second, short and long maturity yields tend to move together – when the long maturity yield declines, typically so too does the short maturity yield. Third, the yield on the long maturity debt is *almost always* higher than the yield on the short maturity debt. Since both short and long term Treasury securities presumably have the same (near-zero) default risk, this difference in yields must be due to something else. There are a couple of exceptions. In particular, short term yields tend to rise above long term yields immediately prior to recessions (denoted with gray shaded regions).

Figure 33.10: Yields: 10 Yr Treasury Note and Three Month Treasury Bill

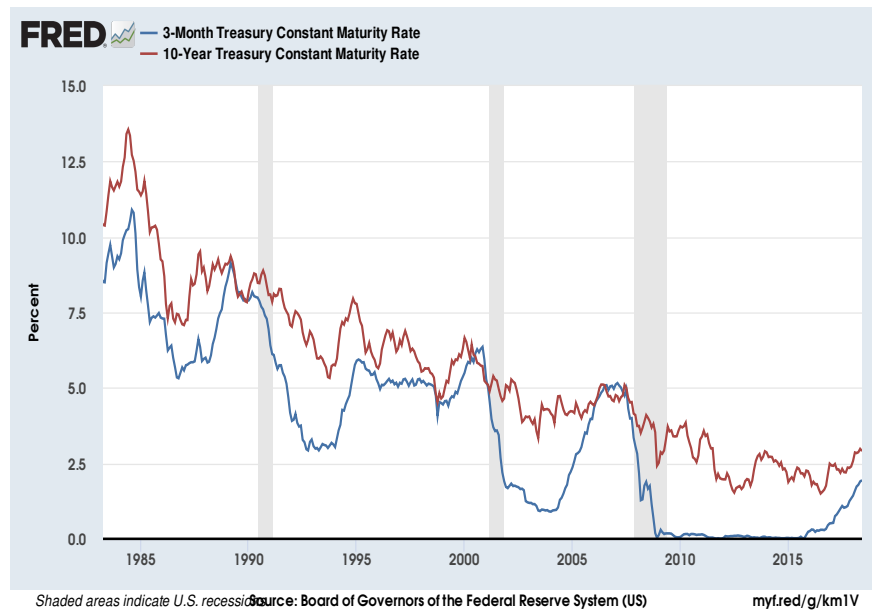

A plot of yields (for securities with similar default probabilities) against time to maturity on the horizontal axis is known as a [yield curve](#). It is most common to plot yield curves using US government debt, which, as noted above, comes in a variety of different maturities. One can observe a yield curve at each particular date. Figure [33.11](#) below plots yield curves observed at different points in the last decade. Consistent with the visual evidence in Figure [33.10](#), the typical yield curve is upward-sloping (i.e. long term yields are greater than short term yields), though this is not the case for the yield curve from 2007.

Figure 33.11: Representative Yield Curves

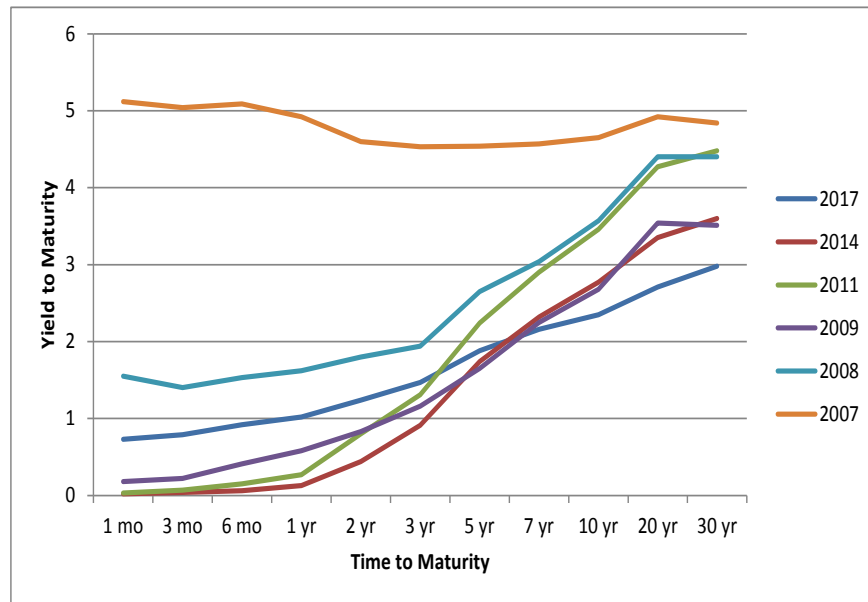

Yield curves typically “flatten” immediately prior to recessions (i.e. long term yields fall in comparison to short term yields, perhaps so much so that the yield curve becomes downward-sloping or “inverted”). We can see this pattern for the last three documented recessions in the US in Figure 33.12 below.

Figure 33.12: Yield Curves Prior to Recent Recessions

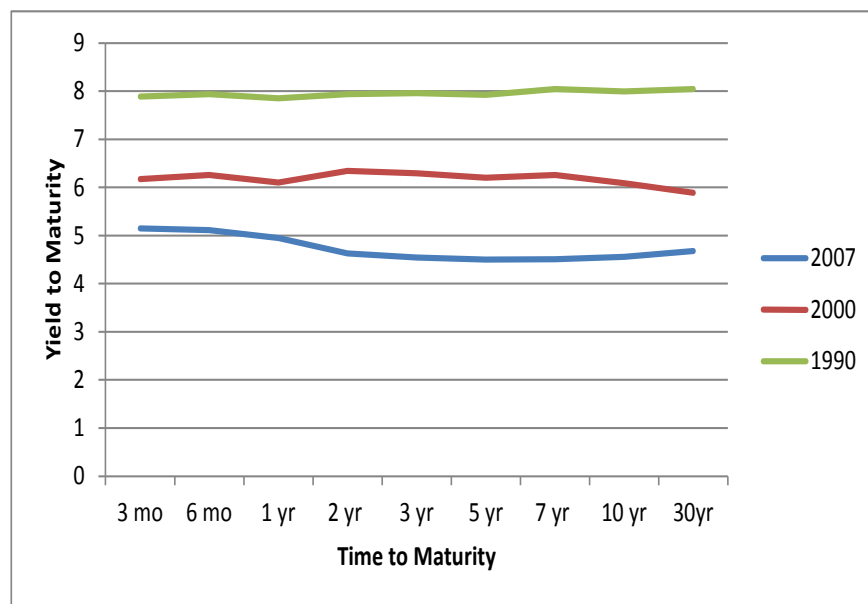

33.4.1 No Uncertainty: The Expectations Hypothesis

Let us now turn to theory to seek to understand the behavior of yields as a function of time to maturity. Let us again suppose that the economy is populated by a single representative household with an exogenous income stream. For now, let us assume that the household lives for *three* periods (instead of just two) and that there is no uncertainty over the future. In particular, there is no uncertainty over future realizations of income and there is no uncertainty over future payouts on bonds (i.e. there is no default risk).

The household begins in period t with no stock of wealth. It lives until period $t + 2$. Its lifetime utility is:

$$U = u(C_t) + \beta u(C_{t+1}) + \beta^2 u(C_{t+2}) \quad (33.54)$$

In period t , the household earns exogenous income stream Y_t . The household may save/borrow through two different kinds of discount bonds. The first, which we will denote $B_{t,t,t+1}$, is a one period maturity discount bond which sells at $P_{t,t,t+1}^B$. The notation here has the following interpretation – the first subscript refers to the date at which a bond is purchased or a price is observed (this is the first t subscript). The second subscript refers to the date of issue of the bond in question (in this case also t). The third subscript is the maturity date, in this case $t + 1$. If a household purchases one unit of this bond, it receives an income flow of 1 in period $t + 1$ with certainty. The second bond to which the household has access will be denoted $B_{t,t,t+2}$. This is a two period maturity discount bond; it sells at $P_{t,t,t+2}^B$ in period t . If the household purchases one unit of this bond in period t and holds it until period $t + 2$, it receives an income flow of 1 in $t + 2$. The household will also have the opportunity to buy or sell previously issued two period bonds in period $t + 1$.

The household's flow budget constraint in period t is given in (33.55). The household may spend its income on consumption or on one or two period maturity bonds.

$$C_t + P_{t,t,t+1}^B B_{t,t,t+1} + P_{t,t,t+2}^B B_{t,t,t+2} \leq Y_t \quad (33.55)$$

In period $t + 1$, the household faces the following budget constraint:

$$C_{t+1} + P_{t+1,t+1,t+2}^B B_{t+1,t+1,t+2} + P_{t+1,t,t+2}^B (B_{t+1,t,t+2} - B_{t,t,t+2}) \leq Y_{t+1} + B_{t,t,t+1} \quad (33.56)$$

What is going on in (33.56)? On the right hand side, the household receives an exogenous income flow of Y_{t+1} and also receives one unit of income for each unit of the one period bond it purchased in period t (i.e. $B_{t,t,t+1}$). With this income, the household can either

consume or purchase/sell newly issued one period bonds (i.e. $B_{t+1,t+1,t+2}$ at price $P_{t+1,t+1,t+2}^B$) or it can purchase/sell two period bonds which were previously issued in period t . The term $B_{t+1,t,t+2} - B_{t,t,t+2}$ denotes the *change* in the household's holdings of two period bonds maturing in $t+2$ – $B_{t,t,t+2}$ is the stock of such bonds the household brings from t to $t+1$, while $B_{t+1,t,t+2}$ is the stock of such bonds the household takes from $t+1$ to $t+2$. If the household wishes to keep its stock of such bonds fixed relative to what it purchased in t , it would simply set $B_{t+1,t,t+2} = B_{t,t,t+2}$. $P_{t+1,t,t+2}^B$ is the market price in period $t+1$ of bonds issued in period t which mature in $t+2$.

The household's budget constraint in $t+2$ (going ahead and imposing the terminal condition that it takes/leaves no bonds after this period) is:

$$C_{t+2} \leq Y_{t+2} + B_{t+1,t+1,t+2} + B_{t+1,t,t+2} \quad (33.57)$$

Imposing the terminal conditions, the household simply consumes all of its available resources in the final period of life. It has income from three sources – exogenous income flow, Y_{t+2} ; maturing one period bonds brought from the previous period, $B_{t+1,t+1,t+2}$; and maturing two period bonds brought from the previous period, $B_{t+1,t,t+2}$.

The household's objective in period t is to pick a consumption/saving plan which maximizes (33.54) subject to (33.55)-(33.57). It will be easiest to characterize optimal behavior by substituting out the consumption terms and instead writing the problem as choosing how many of each type of bond to purchase/sell. Doing so, the household's problem can be written:

$$\max_{B_{t,t,t+1}, B_{t,t,t+2}, B_{t+1,t+1,t+2}, B_{t+1,t,t+2}} U = u \left[Y_t - P_{t,t,t+1}^B B_{t,t,t+1} - P_{t,t,t+2}^B B_{t,t,t+2} \right] + \beta u \left[Y_{t+1} + B_{t,t,t+1} - P_{t+1,t+1,t+2}^B B_{t+1,t+1,t+2} - P_{t+1,t,t+2}^B (B_{t+1,t,t+2} - B_{t,t,t+2}) \right] + \beta^2 u \left[Y_{t+2} + B_{t+1,t+1,t+2} + B_{t+1,t,t+2} \right]$$

The first order conditions are:

$$\frac{\partial U}{\partial B_{t,t,t+1}} = 0 \Leftrightarrow P_{t,t,t+1}^B u'(C_t) = \beta u'(C_{t+1}) \quad (33.58)$$

$$\frac{\partial U}{\partial B_{t,t,t+2}} = 0 \Leftrightarrow P_{t,t,t+2}^B u'(C_t) = \beta P_{t+1,t,t+2}^B u'(C_{t+1}) \quad (33.59)$$

$$\frac{\partial U}{\partial B_{t+1,t+1,t+2}} = 0 \Leftrightarrow \beta P_{t+1,t+1,t+2}^B u'(C_{t+1}) = \beta^2 u'(C_{t+2}) \quad (33.60)$$

$$\frac{\partial U}{\partial B_{t+1,t,t+2}} = 0 \Leftrightarrow \beta P_{t+1,t,t+2}^B u'(C_{t+1}) = \beta^2 u'(C_{t+2}) \quad (33.61)$$

These first order conditions have the usual marginal benefit = marginal cost interpretation. Start with (33.58). Suppose you purchase one unit of a one period bond. This reduces period t consumption by the price of the bond, $P_{t,t,t+1}^B$, which is valued in utility terms by $u'(C_t)$. Hence, the left hand side, $P_{t,t,t+1}^B u'(C_t)$, represents the marginal cost of buying a one period bond in period t . The marginal benefit is extra income of one in period $t + 1$, which is valued in utility terms at $\beta u'(C_{t+1})$. Hence, $\beta u'(C_{t+1})$ is the marginal utility benefit of purchasing a one period bond in period t . At any optimum, the marginal benefit must equal the marginal cost.

Consider next the first order condition for one period bonds bought in period $t + 1$. Note that (33.60) can be re-written:

$$P_{t+1,t+1,t+2}^B u'(C_{t+1}) = \beta u'(C_{t+2}) \quad (33.62)$$

(33.62) has *exactly* the same intuitive interpretation as (33.58), just led forward one period.

Next, let us go to the first order condition for the two period maturity bond. Note that (33.59) and (33.61) can be combined to yield:

$$P_{t,t,t+2}^B u'(C_t) = \beta^2 u'(C_{t+2}) \quad (33.63)$$

(33.63) has a similar intuitive interpretation. If the household buys one unit of the two period bond in period t , it foregoes $P_{t,t,t+2}^B$ units of consumption in period t , which is valued in utility terms at $u'(C_t)$. Hence, the left hand side of (33.63) represents the marginal utility cost of saving in the two period bond. The marginal benefit of saving in the two period bond (and holding it until maturity) is one unit of additional consumption in period $t + 2$. This is valued in utility terms at $\beta^2 u'(C_{t+2})$. At any optimum, the marginal utility benefit must equal the marginal utility cost.

Note also that (33.60)-(33.61) together imply that $P_{t+1,t+1,t+2}^B = P_{t+1,t,t+2}^B$. In other words, in period $t + 1$ the price of two period bonds issued in period t must equal the price of newly issued one period bonds. In other words, all that matters for a bond's price is its remaining time to maturity, not its date of issue.

Now, note that we can combine (33.62)-(33.63) to get:

$$\beta P_{t+1,t+1,t+2}^B u'(C_{t+1}) = P_{t,t,t+2}^B u'(C_t) \quad (33.64)$$

But then we can use (33.58) to write (33.64) as:

$$\beta P_{t+1,t+1,t+2}^B u'(C_{t+1}) = P_{t,t,t+2}^B \frac{\beta u'(C_{t+1})}{P_{t,t,t+1}^B} \quad (33.65)$$

But then (33.65) implies:

$$P_{t,t,t+2}^B = P_{t,t,t+1}^B \times P_{t+1,t+1,t+2}^B \quad (33.66)$$

(33.66) says that the price of a two period bond ought to equal the product of the prices of one period bonds issued today and in $t + 1$. At this point, it is useful to step back and relate bond prices back to yields. Recall that the yield to maturity is the discount rate which equates the price of the bond with the present discounted value of cash flows if the bond is held to maturity. For the two period bond, the yield to maturity satisfies:

$$P_{t,t,t+2}^B = \frac{1}{(1 + r_{2,t})^2} \quad (33.67)$$

(33.67) implicitly defines the yield on the two period bond because it generates a cash flow of one unit two periods into the future. The yield on the one period bond in period t is implicitly defined by:

$$P_{t,t,t+1}^B = \frac{1}{1 + r_{1,t}} \quad (33.68)$$

Similarly, the implied yield on the one period bond issued in period $t + 1$ is:

$$P_{t+1,t+1,t+2}^B = \frac{1}{1 + r_{1,t+1}} \quad (33.69)$$

Combining (33.67)-(33.69) together with (33.66) means that:

$$(1 + r_{2,t})^2 = (1 + r_{1,t})(1 + r_{1,t+1}) \quad (33.70)$$

In other words, the gross compounded yield on the two period bond must equal the product of the sequence of gross yields on the one period bond. What is the intuition for this? Short maturity (in this case one period) and long maturity (in this case, two period) bonds are substitutes. If the household wishes to transfer income from period t to period $t + 2$, it can do so either by: (i) buying a two period bond and holding it until $t + 2$, or (ii) buying a one period bond in t and then taking the proceeds from this and purchasing another one period bond in $t + 1$ (what is sometimes called a “rollover”). For market-clearing, in equilibrium the household must be indifferent between these two options of transferring resources from t to $t + 2$. Why is this? Suppose that $(1 + r_{2,t})^2 > (1 + r_{1,t})(1 + r_{1,t+1})$. The household could make an infinite profit by buying two period bonds and financing this purchase by borrowing through one period bonds (i.e. demand negative quantities of these bonds). This would entail infinite demand for two period bonds and negative infinity demand for one period bonds. The

opposite situation would occur if $(1 + r_{2,t})^2 < (1 + r_{1,t})(1 + r_{2,t})$ – the household would borrow through two period bonds and save through one period bonds, in the process making a profit. In equilibrium, since both bonds are in finite and fixed supply, positive or negative infinity demand is not possible. Hence, $(1 + r_{2,t}) = (1 + r_{1,t})(1 + r_{1,t+1})$ must hold in equilibrium.

(33.70) can be written in approximate form by taking natural logs and using the approximation that the log of one plus a small number is approximately the small number. Doing so yields:

$$r_{t,t+2} \approx \frac{1}{2} [r_{t,t+1} + r_{t+1,t+2}] \quad (33.71)$$

In other words, the yield on the long bond ought to approximately equal the average of the yields on the sequence of short bonds over the maturity of the long bond. (33.71) can be extended for an arbitrary m period maturity bond:

$$r_{t,t+m} \approx \frac{1}{m} [r_{t,t+1} + r_{t+1,t+2} + \dots + r_{t+m-1,t+m}] \quad (33.72)$$

Expression (33.72) is a statement of the [Expectations Hypothesis](#) of the term structure. The expectations hypothesis says that the yield on a long maturity bond is approximately equal to the *average* of expected short maturity yields over the life of the long maturity bond. Put somewhat differently, according to (33.72) the behavior of long maturity yields ought to provide information on market expectations of *future* short maturity interest rates.

The expectations hypothesis is empirically successful on many dimensions. First, because the long bond yield is simply an average of short bond yields, it can easily account for the fact that yields on bonds of different maturities tend to move together. Second, changes in the “slope” of the yield curve (i.e. the difference between long maturity and short maturity yields at a particular point in time) will be predictive of future movements in income. Revert back to our three period example with a one and two period bond. Suppose that the household has log utility. In equilibrium, the bond yields will satisfy:

$$1 + r_{t,t+1} = \frac{1}{\beta} \frac{Y_{t+1}}{Y_t} \quad (33.73)$$

$$(1 + r_{t,t+2})^2 = \frac{1}{\beta^2} \frac{Y_{t+2}}{Y_t} \quad (33.74)$$

$$1 + r_{t,t+1} = \frac{1}{\beta} \frac{Y_{t+2}}{Y_{t+1}} \quad (33.75)$$

Suppose that $Y_t = Y_{t+1}$, but $Y_{t+2} < Y_{t+1}$ (i.e. a “recession” is coming in $t + 2$). This will not affect the current one period bond yield, $r_{t,t+1}$, but will push down $r_{t,t+2}$. In essence, the yield

curve will flatten or become inverted if the household anticipates a coming recession and lower short term yields. This is roughly consistent with the empirical regularity documented in Figure 33.12, for example.

A major failing of the expectations hypothesis of the term structure is that it is unable to account for why yield curves are almost always upward-sloping. In the data, short term yields over very long periods of time are either roughly constant or even trending down (see, e.g., Figure 33.10). Given this, if (33.72) holds, we would expect the typical yield curve to be flat or even downward-sloping, but this is not what we see in the data. Evidently, investors demand a “term premium” in the form of a higher average yield for holding longer maturity debt. In the next subsection, we incorporate uncertainty over future income to motivate the existence of the term premium.

33.4.2 Uncertainty and the Term Premium

Let us continue with the three period example from above in which the household can purchase either one or two period maturity bonds in period t . These bond are default risk-free. Differently from above, let us allow future realizations of the endowment to be uncertain. As we shall see, this uncertainty may be capable of generating a term premium.

The household wishes to maximize expected utility, which in general form using expectations operators is given below:

$$U = u(C_t) + \beta \mathbb{E}[u(C_{t+1})] + \beta^2 \mathbb{E}[u(C_{t+2})] \quad (33.76)$$

Because everything in the present is observed, the period t budget constraint is the same as in the case of no income uncertainty:

$$C_t + P_{t,t,t+1}^B B_{t,t,t+1} + P_{t,t,t+2}^B B_{t,t,t+2} \leq Y_t \quad (33.77)$$

Suppose that future income can take on two possible values: $Y_{t+j}^h \geq Y_{t+j}^l$ for $j = 1, 2$. Assume that the probability of the high state is p , and the probability of the low state is $1 - p$. Assume that the possible realizations of the endowment are the same in period $t + 2$ as in period $t + 1$, and that the probabilities of high or low realizations in $t + 2$ are independent of the realized values of income in period $t + 1$. We could instead assume that the income process is persistent in the precise sense that high income in period $t + 1$ portends high income (in expectation) in period $t + 2$, but we do not lose much by making the simplifying assumption that the income draws in periods $t + 1$ and $t + 2$ are independent from one another.

As when we considered default risk above, flow budget constraints must hold in each possible state of the world. In period $t + 1$, there are two states of the world – either the

endowment is high (probability p), or it is low (probability $1 - p$). The $t + 1$ flow budget constraints in these states of the world are:

$$C_{t+1}^h + P_{t+1,t+1,t+2}^{B,h} B_{t+1,t+1,t+2}^h + P_{t+1,t,t+2}^{B,h} (B_{t+1,t,t+2}^h - B_{t,t,t+2}) \leq Y_{t+1}^h + B_{t,t,t+1} \quad (33.78)$$

$$C_{t+1}^l + P_{t+1,t+1,t+2}^{B,l} B_{t+1,t+1,t+2}^l + P_{t+1,t,t+2}^{B,l} (B_{t+1,t,t+2}^l - B_{t,t,t+2}) \leq Y_{t+1}^l + B_{t,t,t+1} \quad (33.79)$$

In either state of the world, available resources are the exogenous income flow plus one period bonds brought from the previous period. With these resources, the household can consume, accumulate more one period bonds, or change its stock of two period bonds. We index values of consumption, bond prices, and bond holdings in period $t + 1$ with an h or l superscript to refer to the realized state of nature.

In period $t + 2$, while there are again just two states of the world in terms of income, there are an additional two states of the world depending on what happens in $t + 1$. The stock of one and two period bonds which payoff in period $t + 2$ depend on the realized state of the world in $t + 1$. Let $C_{t+2}^{h,l}$, for example, denote consumption in period in period $t + 2$ when income is high in period $t + 2$ *and* when income was is low in period $t + 1$. The first superscript references the $t + 2$ state of the world, while the second references the $t + 1$ state of the world. The budget constraint for this state is summarized in (33.81). (33.80), (33.82), and (33.83) summarize the budget constraints in the other possible states – (h, h) (income is high in $t + 2$ and in $t + 1$); (l, l) (income is low in both $t + 1$ and $t + 2$); and (l, h) (income is low in $t + 2$ but high in $t + 1$). Going ahead and imposing the terminal conditions that the household will not choose to die with a positive stock of assets, and will not be allowed to die in debt, these constraints are:

$$C_{t+2}^{h,h} \leq Y_{t+2}^h + B_{t+1,t+1,t+2}^h + B_{t+1,t,t+2}^h \quad (33.80)$$

$$C_{t+2}^{h,l} \leq Y_{t+2}^h + B_{t+1,t+1,t+2}^l + B_{t+1,t,t+2}^l \quad (33.81)$$

$$C_{t+2}^{l,l} \leq Y_{t+2}^l + B_{t+1,t+1,t+2}^l + B_{t+1,t,t+2}^l \quad (33.82)$$

$$C_{t+2}^{l,h} \leq Y_{t+2}^l + B_{t+1,t+1,t+2}^h + B_{t+1,t,t+2}^h \quad (33.83)$$

The probability of the (h, h) state is just p^2 – the probability income is high in $t + 1$ times the probability income is high in $t + 2$. Similarly, the probability of the (h, l) state is $p(1 - p)$ – the probability income is high in $t + 2$ times the probability it is low in $t + 1$. With this description of uncertainty, expected lifetime utility, (33.76), may be written:

$$U = u(C_t) + p\beta u(C_{t+1}^h) + (1-p)\beta u(C_{t+1}^l) + \dots$$

$$p^2\beta^2 u(C_{t+2}^{h,h}) + p(1-p)\beta^2 u(C_{t+2}^{h,l}) + (1-p)^2\beta^2 u(C_{t+2}^{l,l}) + (1-p)p\beta^2 u(C_{t+2}^{l,h}) \quad (33.84)$$

The household's objective is to pick a state-contingent sequence of consumption (i.e. C_t , C_{t+1}^h , C_{t+1}^l , $C_{t+2}^{h,h}$, and so on) to maximize (33.84) subject to (33.77)-(33.83). As before, it is easier to think about the problem by substituting the consumption values out and instead thinking about an unconstrained problem of choosing a state-contingent sequence of bond holdings. The resulting unconstrained optimization problem is below:

$$\max_{B_{t,t,t+1}, B_{t,t,t+2}, B_{t+1,t+1,t+2}^h, B_{t+1,t+1,t+2}^l, B_{t+1,t,t+2}^h, B_{t+1,t,t+2}^l} U = u[Y_t - P_{t,t,t+1}^B B_{t,t,t+1} - P_{t,t,t+2}^B B_{t,t,t+2}] +$$

$$p\beta u[Y_{t+1}^h + B_{t,t,t+1} - P_{t+1,t+1,t+2}^{B,h} B_{t+1,t+1,t+2}^h - P_{t+1,t,t+2}^{B,h} (B_{t+1,t,t+2}^h - B_{t,t,t+2})] +$$

$$(1-p)\beta u[Y_{t+1}^l + B_{t,t,t+1} - P_{t+1,t+1,t+2}^{B,l} B_{t+1,t+1,t+2}^l - P_{t+1,t,t+2}^{B,l} (B_{t+1,t,t+2}^l - B_{t,t,t+2})] +$$

$$p^2\beta^2 u[Y_{t+2}^h + B_{t+1,t+1,t+2}^h + B_{t+1,t,t+2}^h] + p(1-p)\beta^2 u[Y_{t+2}^h + B_{t+1,t+1,t+2}^l + B_{t+1,t,t+2}^l] +$$

$$(1-p)^2\beta^2 u[Y_{t+2}^l + B_{t+1,t+1,t+2}^l + B_{t+1,t,t+2}^l] + (1-p)p\beta^2 u[Y_{t+2}^l + B_{t+1,t+1,t+2}^h + B_{t+1,t,t+2}^h] \quad (33.85)$$

The first order conditions are:

$$\frac{\partial U}{\partial B_{t,t,t+1}} = 0 \Leftrightarrow P_{t,t,t+1}^B u'(C_t) = \beta[p u'(C_{t+1}^h) + (1-p)u'(C_{t+1}^l)] \quad (33.86)$$

$$\frac{\partial U}{\partial B_{t,t,t+2}} = 0 \Leftrightarrow P_{t,t,t+2}^B u'(C_t) = \beta[p P_{t+1,t,t+2}^{B,h} u'(C_{t+1}^h) + (1-p)P_{t+1,t,t+2}^{B,l} u'(C_{t+1}^l)] \quad (33.87)$$

$$\frac{\partial U}{\partial B_{t+1,t+1,t+2}^h} = 0 \Leftrightarrow p\beta P_{t+1,t+1,t+2}^{P,h} u'(C_{t+1}^h) = \beta^2[p^2 u'(C_{t+2}^h) + (1-p)p u'(C_{t+2}^l)] \quad (33.88)$$

$$\frac{\partial U}{\partial B_{t+1,t+1,t+2}^l} = 0 \Leftrightarrow (1-p)\beta P_{t+1,t+1,t+2}^{P,l} u'(C_{t+1}^l) = \beta^2[p(1-p)u'(C_{t+2}^h) + (1-p)^2 u'(C_{t+2}^l)] \quad (33.89)$$

$$\frac{\partial U}{\partial B_{t+1,t,t+2}^h} = 0 \Leftrightarrow p\beta P_{t+1,t,t+2}^{B,h} u'(C_{t+1}^h) = \beta^2[p^2 u'(C_{t+2}^h) + (1-p)p u'(C_{t+2}^l)] \quad (33.90)$$

$$\frac{\partial U}{\partial B_{t+1,t,t+2}^l} = 0 \Leftrightarrow (1-p)\beta P_{t+1,t,t+2}^{B,l} u'(C_{t+1}^l) = \beta^2[p(1-p)u'(C_{t+2}^h) + (1-p)^2 u'(C_{t+2}^l)] \quad (33.91)$$

These appear a bit nasty but have fairly intuitive interpretations. Note first that in terms of the expectations operator (33.86) is simply:

$$P_{t,t,t+1}^B u'(C_t) = \beta \mathbb{E}[u'(C_{t+1})] \quad (33.92)$$

(33.92) is a familiar bond-pricing condition allowing for uncertainty over future income. In particular, the price of the one period bond in period t is simply the expected value of the stochastic discount factor (since we can re-write the condition as $P_{t,t,t+1}^B = \mathbb{E}\left[\frac{\beta u'(C_{t+1})}{u'(C_t)}\right]$ since both C_t and β are known at the time the expectation is made).

Again in terms of expectations operators, note that (33.87) can be written:

$$P_{t,t,t+2}^B u'(C_t) = \beta \mathbb{E}[P_{t+1,t,t+2}^B u'(C_{t+1})] \quad (33.93)$$

(33.93) can be re-written:

$$P_{t,t,t+2} = \mathbb{E}\left[\frac{\beta u'(C_{t+1})}{u'(C_t)} P_{t+1,t,t+2}^B\right] \quad (33.94)$$

(33.94) is simply the standard asset pricing condition – the price of an asset is the expected value of the product of the stochastic discount factor with the payout of the bond. One way to think of the payout in period $t + 1$ of buying a two period bond in t is that the payout is simply the price of the two period bond in $t + 1$ (i.e. $P_{t+1,t,t+2}^B$), since the household can sell the bond and raise this amount of funds.

If one combines (33.88) with (33.90), and (33.89) with (33.91), one gets:

$$P_{t+1,t+1,t+2}^{B,h} = P_{t+1,t,t+2}^{B,h} \quad (33.95)$$

$$P_{t+1,t+1,t+2}^{B,l} = P_{t+1,t,t+2}^{B,l} \quad (33.96)$$

These are intuitive. They simply say that the price of newly issued one period bonds must equal the price of previously issued two period bonds in period $t + 1$ regardless of the state of the world. We also see this in the world without uncertainty. The only thing relevant for the price of a bond is its remaining time to maturity, not its date of issuance.

(33.88)-(33.89) together imply that:

$$\mathbb{E}[P_{t+1,t+1,t+2}^B u'(C_{t+1})] = \beta \mathbb{E}[u'(C_{t+2})] \quad (33.97)$$

Plugging (33.97) into (33.93), we get:

$$P_{t,t,t+2}^B u'(C_t) = \beta^2 \mathbb{E}[u'(C_{t+2})] \quad (33.98)$$

(33.98) can also be re-written:

$$P_{t,t,t+2}^B = \mathbb{E} \left[\frac{\beta^2 u'(C_{t+2})}{u'(C_t)} \right] \quad (33.99)$$

(33.99) has *exactly* the same interpretation as (33.93). The price of the asset must be the product of the stochastic discount factor and the payout from the bond. If the bond is held to maturity in $t + 2$, the payout is 1 with certainty in $t + 2$. The relevant stochastic discount factor is $\frac{\beta^2 u'(C_{t+2})}{u'(C_t)}$. Whether the bond is held to maturity (i.e. (33.99)), or sold after one period (i.e. (33.93)), the basic asset pricing optimality condition must hold.

As we did above in the case of no uncertainty, we wish to derive a relationship between the prices of bonds with different maturities. Take (33.93), noting that $P_{t+1,t,t+2}^B = P_{t+1,t+1,t+2}^B$ regardless of the state of nature, and divide it by (33.92). After re-arranging terms a bit, one gets:

$$P_{t,t,t+2}^B = P_{t,t,t+1}^B \frac{\mathbb{E}[P_{t+1,t+1,t+2}^B u'(C_{t+1})]}{\mathbb{E}[u'(C_{t+1})]} \quad (33.100)$$

Multiply and divide (33.100) by $\mathbb{E}[P_{t+1,t+1,t+2}^B]$. One gets:

$$P_{t,t,t+2}^B = P_{t,t,t+1}^B \mathbb{E}[P_{t+1,t+1,t+2}^B] \frac{\mathbb{E}[P_{t+1,t+1,t+2}^B u'(C_{t+1})]}{\mathbb{E}[P_{t+1,t+1,t+2}^B] \mathbb{E}[u'(C_{t+1})]} \quad (33.101)$$

One would be tempted to distribute the expectations operator through the term $\mathbb{E}[P_{t+1,t+1,t+2}^B u'(C_{t+1})]$ in (33.101). If one could do this, the fraction would cancel out, leaving just the term:

$$P_{t,t,t+2}^B = P_{t,t,t+1}^B \mathbb{E}[P_{t+1,t+1,t+2}^B] \quad (33.102)$$

(33.102) would be the natural analog of (33.66) accounting for the fact that $P_{t+1,t+1,t+2}^B$ is not necessarily known in advance in period t . The expectations operator can only be distributed in this way if (i) there is no uncertainty over the future, as in the previous subsection, or (ii) the marginal utility of consumption is linear, so that $u''(\cdot) = 0$. If neither of these conditions are satisfied, it is not possible to distribute the expectations operator in this way. As noted above, the expected value of a product of random variables is the product of the expectations plus the covariance between the variables. Making use of this fact, we can write (33.101) as:

$$P_{t,t,t+2}^B = P_{t,t,t+1}^B \mathbb{E}[P_{t+1,t+1,t+2}^B] \left(\frac{\mathbb{E}[P_{t+1,t+1,t+2}^B] \mathbb{E}[u'(C_{t+1})] + \text{cov}(P_{t+1,t+1,t+2}^B, u'(C_{t+1}))}{\mathbb{E}[P_{t+1,t+1,t+2}^B] \mathbb{E}[u'(C_{t+1})]} \right) \quad (33.103)$$

(33.103) simplifies to:

$$P_{t,t,t+2}^B = P_{t,t,t+1}^B \mathbb{E}[P_{t+1,t+1,t+2}^B] \left(1 + \frac{\text{cov}(P_{t+1,t+1,t+2}^B, u'(C_{t+1}))}{\mathbb{E}[P_{t+1,t+1,t+2}^B] \mathbb{E}[u'(C_{t+1})]} \right) \quad (33.104)$$

Since consumption equals income in equilibrium, the equilibrium two period bond price satisfies:

$$P_{t,t,t+2}^B = \underbrace{P_{t,t,t+1}^B \mathbb{E}[P_{t+1,t+1,t+2}^B]}_{\text{Expectations Hypothesis}} \underbrace{\left(1 + \frac{\text{cov}(P_{t+1,t+1,t+2}^B, u'(Y_{t+1}))}{\mathbb{E}[P_{t+1,t+1,t+2}^B] \mathbb{E}[u'(Y_{t+1})]} \right)}_{\text{Term Premium}} \quad (33.105)$$

The price of the two period bond in equilibrium is the product of two terms. The first term we will call the expectations hypothesis term – this is simply the product of the current and expected future short bond price, $P_{t,t,t+1}^B \mathbb{E}[P_{t+1,t+1,t+2}^B]$. The second term is what we will call the term premium term, and is given by $\left(1 + \frac{\text{cov}(P_{t+1,t+1,t+2}^B, u'(Y_{t+1}))}{\mathbb{E}[P_{t+1,t+1,t+2}^B] \mathbb{E}[u'(Y_{t+1})]} \right)$. If there is no uncertainty, if the marginal utility of consumption is constant, or if the covariance between the future one period bond price and the future marginal utility of consumption term is zero, then this term is one, and the expectations hypothesis as laid out in the previous subsection under certainty would hold. Otherwise, the simple expectations hypothesis does not hold exactly, though the logic of the expectations hypothesis is still at play. In particular, changes in expected future short maturity bond prices ought to be reflected in current long maturity bond prices holding the term premium term fixed.

We would in general expect the covariance term in (33.105) to be *negative*. Why is this? Note that (33.88)-(33.89) together imply that, regardless of the state of nature in $t + 1$, we must have $P_{t+1,t+1,t+2}^h u'(C_{t+1}^h) = P_{t+1,t+1,t+2}^l u'(C_{t+1}^l)$. In other words, the following must hold:

$$P_{t+1,t+1,t+2} u'(C_{t+1}) = \beta \mathbb{E}_{t+1}[u'(C_{t+2})] \quad (33.106)$$

In (33.106), $\mathbb{E}_{t+1}[\cdot]$ is the expectations operator *conditional* on the realization of the state in $t + 1$ (whereas in the notation we have been using $\mathbb{E}[\cdot]$ is the expectation operator conditional on information observed in t). In other words, (33.106) must hold in all states of the world. In equilibrium, the price of the one period bond in $t + 1$, regardless of the state of nature in that period, will therefore be:

$$P_{t+1,t+1,t+2}^B = \frac{\beta \mathbb{E}_{t+1}[u'(Y_{t+2})]}{u'(Y_{t+1})} \quad (33.107)$$

When Y_{t+1} is high, for example, $u'(Y_{t+1})$ will be low, and therefore $P_{t+1,t+1,t+2}^B$ will be high. The reverse will be true when Y_{t+1} is in the low state. The intuition for this relates to the household's desire to smooth consumption. If it receives a high endowment in $t + 1$, it

will want to increase its saving, which requires holding more of the one period bond. The increased demand for the bond pushes its equilibrium price up (and yield down), because in equilibrium there can be no saving in an endowment economy. Hence, we would expect $P_{t+1,t+1,t+2}^B$ to be high when $u'(Y_{t+1})$ is low. This means that the covariance term is *negative*, and hence the two period bond ought to trade at a discount relative to the product of the expected sequence of one period bond prices (i.e. $\left(1 + \frac{\text{cov}(P_{t+1,t+1,t+2}^B, u'(Y_{t+1}))}{\mathbb{E}[P_{t+1,t+1,t+2}^B] \mathbb{E}[u'(Y_{t+1})]}\right)$ ought to be less than one).

We therefore see that there *is* risk associated with the long bond even though we have assumed away default risk. This form of risk is sometimes called **interest rate risk**. There is an intuitive way to think about this form of risk. It is easiest to do so if we think about a situation in which the household buys a two period bond in period t and has to sell it in $t+1$. In other words, focus on (33.93). Since the price of the long bond in period $t+1$ must equal the price of the one period bond in $t+1$, if $P_{t+1,t+1,t+2}^B$ is lower than anticipated (i.e. the yield is higher), the household gets a *lower* payout on the long bond than it anticipated. $P_{t+1,t+1,t+2}^B$ is likely to be lower than expected when Y_{t+1} is lower than expected (low Y_{t+1} makes the household want to borrow in $t+1$ and reduces demand for the bond). Low Y_{t+1} means that the marginal utility of consumption is comparatively high. In other words, the long bond has a low return in a period in which the household most values a high return. If $P_{t+1,t+1,t+2}^B$ is higher than expected (short term yields are lower than expected), in contrast, the household gets a bigger payout on the long bond than it anticipated because $P_{t+1,t,t+2}^B$ will be higher than anticipated. But $P_{t+1,t+1,t+2}^B$ is likely to be high when Y_{t+1} is high, which is a period in which the household places a comparatively small weight on an extra payout (i.e. $u'(Y_{t+1})$ is small). For this reason, the household requires a premium to hold the long bond in the form of a lower price than would be predicted by the simple expectations hypothesis.

(33.105) is written in terms of bond prices, whereas for the usual reasons we would prefer to work with yields. Take the inverse of (33.105) to get:

$$\frac{1}{P_{t,t,t+2}^B} = \frac{1}{P_{t,t,t+1}^B} \frac{1}{\mathbb{E}[P_{t+1,t+1,t+2}^B]} \left(1 + \frac{\text{cov}(P_{t+1,t+1,t+2}^B, u'(Y_{t+1}))}{\mathbb{E}[P_{t+1,t+1,t+2}^B] \mathbb{E}[u'(Y_{t+1})]}\right)^{-1} \quad (33.108)$$

Or, in terms of yields:

$$(1 + r_{t,t+2})^2 = (1 + r_{t,t+1}) \frac{1}{\mathbb{E}[P_{t+1,t+1,t+2}^B]} \left(1 + \frac{\text{cov}(P_{t+1,t+1,t+2}^B, u'(Y_{t+1}))}{\mathbb{E}[P_{t+1,t+1,t+2}^B] \mathbb{E}[u'(Y_{t+1})]}\right)^{-1} \quad (33.109)$$

A complication arises in (33.109). This is that the expected one period yield is $\mathbb{E}\left[\frac{1}{P_{t+1,t+1,t+2}^B}\right]$,

which is in general *not* $\frac{1}{\mathbb{E}[P_{t+1,t+1,t+2}^B]}$. This would be the case if there were no uncertainty (or if the second derivative of the utility function were zero), but neither of these conditions will in general hold. We will ignore this complication and treat $\frac{1}{\mathbb{E}[P_{t+1,t+1,t+2}^B]}$ as the expected yield on the one period bond. More precisely, we can think of this as expectation of the *risk-neutral* one period yield (i.e. the yield that would be expected in the absence of the risk aversion (positive second derivative of utility function) and/or the absence of uncertainty). Doing so, we can write (33.109) as:

$$(1 + r_{t,t+2})^2 = (1 + r_{t,t+1}) \mathbb{E}[1 + r_{t+1,t+2}] \left(1 + \frac{\text{cov}(P_{t+1,t+1,t+2}^B, u'(Y_{t+1}))}{\mathbb{E}[P_{t+1,t+1,t+2}^B] \mathbb{E}[u'(Y_{t+1})]} \right)^{-1} \quad (33.110)$$

If we take logs of (33.110), making use of the approximation that the log of one plus a small number is approximately the small number, we get:⁵

$$r_{t,t+2} \approx \underbrace{\frac{1}{2} [r_{t,t+1} + \mathbb{E}[r_{t+1,t+2}]]}_{\text{Expectations Hypothesis}} + \underbrace{\frac{1}{2} tp_t}_{\text{Term Premium}} \quad (33.111)$$

(33.111) is the same as (33.71), with an additional term we call the term premium. In (33.111), the term $tp_t = -\ln\left(1 + \frac{\text{cov}(P_{t+1,t+1,t+2}^B, u'(Y_{t+1}))}{\mathbb{E}[P_{t+1,t+1,t+2}^B] \mathbb{E}[u'(Y_{t+1})]}\right)$. If the covariance is negative, as we expect, the term inside the parentheses will be less than 1, so the natural log of this will be negative. Since a $-$ multiplies this term, we would therefore expect the term premium to be *positive*. This is the natural analog to the idea that the long bond should sell at a discount relative to the expected sequence of short bond prices; if this is true, the long bond must offer a higher yield. This higher yield is a compensation for the additional risk that long bonds carry and is what we call the term premium.

It may be beneficial to use some numbers to generate a numeric example. Suppose that $Y_t = 1$ and $\beta = 0.95$, with the utility function the natural log. Future income can take on a high or a low value. Suppose $Y_{t+1}^h \geq Y_{t+1}^l$ and $Y_{t+2}^h \geq Y_{t+2}^l$. Suppose that the high state occurs with probability p and the low state with probability $1 - p$. Suppose that $Y_{t+1}^h = Y_{t+2}^h = 1.1$ and that $Y_{t+1}^l = Y_{t+2}^l = 0.90$, with $p = 0.5$. This means that the expected value of future income equals the current value (i.e. 1). We can solve for bond prices and yields. The price of the one period bond in period t is $P_{t,t+1}^B = 0.96$, with a yield of about 0.042. The price of the two period bond is $P_{t,t,t+2}^B = 0.91$. The implied yield to maturity on the two year bond is 0.047. In other words, the yield curve slopes up – the long bond yield exceeds the short bond

⁵In addition, we are making another approximation, because in general $\ln(\mathbb{E}[X]) \neq \mathbb{E}[\ln(X)]$ for some random variable X .

yield – even though in expectation the future endowment looks just like the present. The expected future one period bond price is the same as the current bond price. Hence, the risk-free expected one period yield is the same as the current one period yield. This means that our model attributes the positive slope of the yield curve to a positive term premium of about 0.005 (50 basis points).

Incorporating uncertainty and allowing for a term premium addresses an important failure of the expectations hypothesis of the term structure, which is that the expectations hypothesis cannot account for why the typical yield curve observed in the data is upward-sloping. This augmented model taking into account uncertainty can generate an upward-sloping yield curve even if expected short term yields are not rising. Yet the augmented model with uncertainty retains some of the intuition of the expectations hypothesis for why the shape of the yield curve might change from time to time. To see this, continue with the numerical example outlined in the paragraph above, but assume that $Y_{t+2}^h = 1.05$ and $Y_{t+2}^l = 0.85$. In other words, the expected value of output in $t + 2$ is lower than in $t + 1$ or t – i.e. a “recession” is coming. What effect does this have on the prices of short and long maturity bonds and the associated yields? The price of the one period bond in period t , and its associated yield, are the same as in the paragraph above. But the price of the two period bond rises, and hence its yield falls. In particular, we have $P_{t,t,t+2}^B = 0.96$, which implies a yield of $\left(\frac{1}{0.96}\right)^{\frac{1}{2}} = 0.02$. Hence, the long bond now has a *lower* yield than the short bond, i.e. the yield curve slopes down instead of up. This is consistent with the empirical facts documented above that flat or inverted yield curves often precede recessions. The reason why the yield curve becomes inverted here is because $\mathbb{E}[P_{t+1,t+1,t+2}^B]$ rises (so the expected future one period yield falls). The implied term premium is still roughly 50 basis points, as in the example above.

It is reasonably straightforward, if not a bit laborious, to extend beyond three periods. A general pattern emerges which is already evident in the three period model. Suppose that time extends for four periods – t , $t + 1$, $t + 2$, and $t + 3$. In period t , the household can purchase newly issued one period bonds, two period bonds, or three period bonds. Its budget constraint in period t is:

$$C_t + P_{t,t,t+1}^B B_{t,t,t+1} + P_{t,t,t+2}^B B_{t,t,t+2} + P_{t,t,t+3}^B B_{t,t,t+3} \leq Y_t \quad (33.112)$$

Without explicitly laying out the nature of uncertainty or fully specifying the future budget constraints which must hold in each state of the world, we will skip straight ahead to the optimality conditions which must hold in period t . These are analogous to (33.92) and (33.93) for the three period case, although there is an additional condition for the three period bond:

$$P_{t,t,t+1}^B u'(C_t) = \beta \mathbb{E}[u'(C_{t+1})] \quad (33.113)$$

$$P_{t,t,t+2}^B u'(C_t) = \beta \mathbb{E}[P_{t+1,t,t+2}^B u'(C_{t+1})] \quad (33.114)$$

$$P_{t,t,t+3}^B u'(C_t) = \beta \mathbb{E}[P_{t+1,t,t+3}^B u'(C_{t+1})] \quad (33.115)$$

In equilibrium, consumption will equal income regardless of date or state of nature. Hence we can impose this market-clearing condition to solve for equilibrium bond prices. (33.114) can be combined with (33.113) to yield:

$$P_{t,t,t+2}^B = P_{t,t,t+1}^B \frac{\mathbb{E}[P_{t+1,t,t+2}^B u'(Y_{t+1})]}{\mathbb{E}[u'(Y_{t+1})]} \quad (33.116)$$

Regardless of the state of nature in $t+1$, it again must be the case that $P_{t+1,t,t+2}^B = P_{t+1,t+1,t+2}^B$ (i.e. all that matters for the price of a bond is its remaining time to maturity, not its date of issuance). Making use of this fact, (33.116) can be written in exactly the same way as we did above in the three period case, giving:

$$P_{t,t,t+2}^B = P_{t,t,t+1}^B \mathbb{E}[P_{t+1,t+1,t+2}^B] \frac{\mathbb{E}[P_{t+1,t+1,t+2}^B u'(Y_{t+1})]}{\mathbb{E}[P_{t+1,t+1,t+2}^B] \mathbb{E}[u'(Y_{t+1})]} \quad (33.117)$$

Making use of the relationship between covariance and expectations, (33.117) can be written:

$$P_{t,t,t+2}^B = P_{t,t,t+1}^B \mathbb{E}[P_{t+1,t+1,t+2}^B] \left(1 + \frac{\text{cov}(P_{t+1,t+1,t+2}^B, u'(Y_{t+1}))}{\mathbb{E}[P_{t+1,t+1,t+2}^B] \mathbb{E}[u'(Y_{t+1})]} \right) \quad (33.118)$$

(33.118) expresses the price of the two period bond as a function of the product of the current and expected one period bond prices multiplied by a term related to covariance. It is *exactly* the same expression that we derived above, (33.105). Now let us turn to the three period bond. Take (33.115) and combine it with (33.114) to get:

$$P_{t,t,t+3}^B = P_{t,t,t+2}^B \frac{\mathbb{E}[P_{t+1,t,t+3}^B u'(Y_{t+1})]}{\mathbb{E}[P_{t+1,t,t+2}^B u'(Y_{t+1})]} \quad (33.119)$$

In looking at (33.120), note that $P_{t+1,t,t+3}^B = P_{t+1,t+1,t+3}^B$ (i.e. the price of a previously issued three period bond with two periods until maturity will equal the price of a newly issued two period bond) and $P_{t+1,t,t+2}^B = P_{t+1,t+1,t+2}^B$ (i.e. the price of a previously issued two period bond with one period to maturity will equal the price of a newly issued one period bond). We can then write:

$$P_{t,t,t+3}^B = P_{t,t,t+2}^B \frac{\mathbb{E}[P_{t+1,t+1,t+3}^B u'(Y_{t+1})]}{\mathbb{E}[P_{t+1,t+1,t+2}^B u'(Y_{t+1})]} \quad (33.120)$$

(33.113) and (33.114) will hold in expectation for period $t + 1$, effectively determining the prices of the one and two period bonds in $t + 1$. In particular:

$$\mathbb{E}[P_{t+1,t+1,t+2}^B u'(Y_{t+1})] = \beta \mathbb{E}[u'(Y_{t+2})] \quad (33.121)$$

$$\mathbb{E}[P_{t+1,t+1,t+3}^B u'(Y_{t+1})] = \beta \mathbb{E}[P_{t+2,t+2,t+3}^B u'(Y_{t+2})] \quad (33.122)$$

Combine (33.121)-(33.122) with (33.120) to get:

$$P_{t,t,t+3}^B = P_{t,t,t+2}^B \frac{\mathbb{E}[P_{t+2,t+2,t+3}^B u'(Y_{t+2})]}{\mathbb{E}[u'(Y_{t+2})]} \quad (33.123)$$

Multiplying and dividing the right hand side (33.123) by $\mathbb{E}[P_{t+2,t+2,t+3}^B]$, we get:

$$P_{t,t,t+3}^B = P_{t,t,t+2}^B \mathbb{E}[P_{t+2,t+2,t+3}^B] \frac{\mathbb{E}[P_{t+2,t+2,t+3}^B u'(Y_{t+2})]}{\mathbb{E}[P_{t+2,t+2,t+3}^B] \mathbb{E}[u'(Y_{t+2})]} \quad (33.124)$$

Via logic used above, the fraction on the right hand side of (33.124) may be written in terms of covariance. Therefore:

$$P_{t,t,t+3}^B = P_{t,t,t+2}^B \mathbb{E}[P_{t+2,t+2,t+3}^B] \left(1 + \frac{\text{cov}(P_{t+2,t+2,t+3}^B, u'(Y_{t+2}))}{\mathbb{E}[P_{t+2,t+2,t+3}^B] \mathbb{E}[u'(Y_{t+2})]} \right) \quad (33.125)$$

Now, we can use (33.118) to substitute $P_{t,t,t+2}$ out of (33.125). Re-arranging terms a bit, we get:

$$P_{t,t,t+3}^B = \underbrace{P_{t,t,t+1}^B \mathbb{E}[P_{t+1,t+1,t+2}^B] \mathbb{E}[P_{t+2,t+2,t+3}^B]}_{\text{Expectations Hypothesis}} \underbrace{\left(1 + \frac{\text{cov}(P_{t+1,t+1,t+2}^B, u'(Y_{t+1}))}{\mathbb{E}[P_{t+1,t+1,t+2}^B] \mathbb{E}[u'(Y_{t+1})]} \right) \left(1 + \frac{\text{cov}(P_{t+2,t+2,t+3}^B, u'(Y_{t+2}))}{\mathbb{E}[P_{t+2,t+2,t+3}^B] \mathbb{E}[u'(Y_{t+2})]} \right)}_{\text{Term Premium}} \quad (33.126)$$

Note that (33.126) is very similar to (33.105) but allows for more periods. In particular, the price of the three period bond is equal to the product of the current and expected sequence of one period bond prices over the life of the three period bond (the expectations hypothesis component) times *two* terms related to the covariance between the price of a one period bond and the marginal utility of consumption. Although one of these terms is dated $t + 1$ and the other $t + 2$, each is simply related to the covariance between the one period bond price in a period with the marginal utility of consumption in that same period. As such, these terms

should be the *same*. In particular, define:

$$TP_t = \left(1 + \frac{\text{cov}(P_{t+1,t+1,t+2}^B, u'(Y_{t+1}))}{\mathbb{E}[P_{t+1,t+1,t+2}^B] \mathbb{E}[u'(Y_{t+1})]} \right) \quad (33.127)$$

We can therefore write (33.126) as:

$$P_{t,t,t+3}^B = P_{t,t,t+1}^B \mathbb{E}[P_{t+1,t+1,t+2}^B] \mathbb{E}[P_{t+2,t+2,t+3}^B] TP_t^2 \quad (33.128)$$

Writing in terms of yields, and making the same approximation as above in the three period case that the inverse of the expected bond price can be treated as the expected yield, we can write (33.128) as:

$$(1 + r_{t,t+3})^3 = (1 + r_{t,t+1}) \mathbb{E}[1 + r_{t+1,t+2}] \mathbb{E}[1 + r_{t+2,t+3}] TP_t^{-2} \quad (33.129)$$

Taking logs and making use of the approximation that the log of one plus a small number is the small number, (33.129) may be written:

$$r_{t,t+3} \approx \frac{1}{3} [r_{t,t+1} + \mathbb{E}[r_{t+1,t+2}] + \mathbb{E}[r_{t+2,t+3}]] + \frac{2}{3} tp_t \quad (33.130)$$

This is very similar to (33.111) but allows for one more period. The three period yield is approximately the average of expected one period yields over the life of the three period bond (the expectations hypothesis component) plus another component. In (33.130), we have defined $tp_t = -\ln(TP_t)$. This is *exactly* the same term as in (33.111) for the two period yield, but is weighted by $\frac{2}{3}$ instead of $\frac{1}{2}$. This is the term premium term, but because it is weighted by $\frac{2}{3} > \frac{1}{2}$, we would expect the term premium on the three period bond to be *bigger* than on the two period bond.

We will not do so explicitly, but if one extends to an arbitrary number of periods until maturity, $m > 1$, one arrives at the following expression:

$$r_{t,t+m} \approx \underbrace{\frac{1}{m} [r_{t,t+1} + \dots + \mathbb{E}[r_{t+m-1,t+m}]]}_{\text{Expectations Hypothesis}} + \underbrace{\frac{m-1}{m} tp_t}_{\text{Term Premium}} \quad (33.131)$$

In other words, the yield on a m period bond is approximately the average of current and expected one period bonds over the life of the m period bond (the expectations hypothesis component), plus a term premium component that is *increasing* in m . One can see that (33.111) and (33.130) are special cases of (33.131) when $m = 2$ or $m = 3$. As m gets big, the term $\frac{m-1}{m}$ should settle down and approach one. Hence, the term premium should be positive, increasing in time to maturity (i.e. $\frac{m-1}{m}$ is increasing in m), but increasing at a decreasing

rate (i.e. $\frac{m-1}{m}$ settles down to one as m gets big). Put slightly differently, the difference in term premia for a two versus three period bond ought to be *bigger* than the difference in term premia between twenty and twenty-one period bond.

In Figure 33.13 below, we postulate an expected sequence of one period interest rates over a 30 period horizon. We assume that the value of the tp term is fixed at 0.8. We then use the postulated sequence of short term interest rates, the assumed value of the tp term, and (33.131) to measure yields on bonds ranging in maturity from one period to $m = 30$. In the upper row, we consider a situation in which the current and expected short term yields are constant at 4.5 percent. The yield curve is nevertheless upward-sloping, because, as show in the upper right panel, the term premium is positive for maturities greater than one period and increasing in the maturity. The shape of the implied yield curve in the upper left quadrant is roughly consistent with the typical yield curve observed in the data.

Figure 33.13: The Yield Curve and the Term Premium

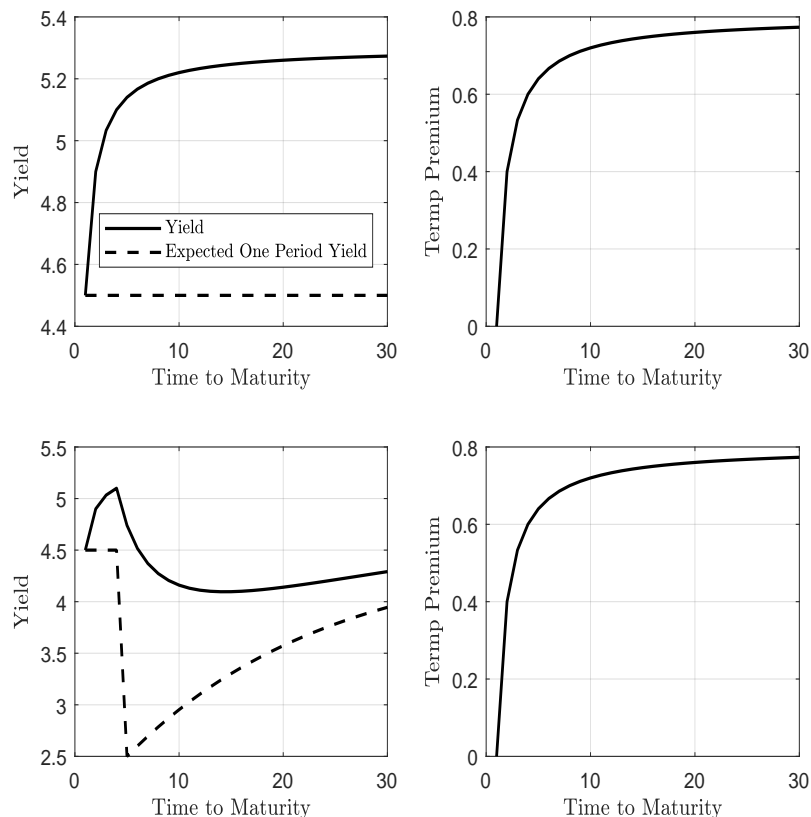

In the lower row we postulate a different path for the short term yield. In particular, we assume that it is constant at 4.5 for four periods. Then it drops to 2.5 in the fifth period.

Thereafter it smoothly approaches the value of 4.5 We observe that this expectation of falling short term yields does in fact result in the yield curve inverting – though upward-sloping for a few periods, with yields on bonds with maturities greater than 5 periods less than the current one period yield. This inversion is roughly consistent with what is observed in the data immediately prior to most recessions.

33.5 Conventional versus Unconventional Monetary Policy

Although this chapter is about bond pricing, we conclude it with a brief discussion of monetary policy. As discussed in Chapter 31, conventional monetary policy works through bond markets. Central banks buy or sell short term government debt. This buying or selling impacts the prices (yields) of short term government debt and ultimately spills over to the prices (yields) on debt instruments relevant for economic activity.

We have studied a micro-founded general equilibrium model with both short and long term riskless debt as well as a model with both riskless and risky debt. We have not yet studied these together. The next subsection does so, though much of the analysis is repetitive with what has already been presented in this chapter and may be skipped. We briefly summarize the key points here. Most private investment is financed with long term debt (think about a 30 year mortgage for a household purchasing a home, or a 10 year corporate bond for a firm looking to finance a new factory). The reason this debt is mostly long term is because the underlying projects take a long time to generate significant cash flows. But if interest rates on longer term risky debt are what is relevant for economic activity, how does monetary policy, which typically influences short term, riskless interest rates, impact the economy?

From a saver's perspective, the key point is that bonds of different types (either differing in maturity or default risk) are *substitutes*. Purchasing bonds is simply a means by which to transfer resources intertemporally and hence to smooth consumption. In fact, once one adjusts for risk (potentially both default risk and maturity/duration risk), different types of bonds are *perfect substitutes*. This means that the prices/yields on different types of bonds are intimately related to one another.

Conventional monetary policy works through adjusting short term, riskless interest rates. Because of the substitutability among different types of debt, this in turn filters through to the longer maturity and risky rates relevant for important economic decisions. Facing the ZLB post-2008, conventional policies were unavailable to central banks around the world since short term, riskless (nominal) interest rates were bound from below by zero. These central banks therefore resorted to unconventional policy actions which sought to impact the economically-relevant interest rates through means other than adjusting short term riskless

rates.

The next subsection provides a formal model with three periods. It allows for both short and long term riskless government debt as well as long maturity debt which has default risk. We can think about the latter as corporate debt, a mortgage rate, or a corporate borrowing rate. It is the economically relevant interest rate for investment decisions. We then formally derive conditions that relate the prices (yields) on different types of debt together. We conclude the section with a graphical discussion of conventional versus unconventional policy measures designed to impact economically-relevant interest rates.

We should note here that we are presenting all of this material in a purely *real* model. Monetary policy requires some kind of *nominal* friction (either price or wage stickiness) to have real effects. Furthermore, for monetary policy to have real effects, output must be endogenous, whereas we are working in the confines of an endowment economy model in which output is exogenous. At the expense of significantly complicating the analysis, we could modify our framework to account for these issues without fundamentally altering any of the conclusions. In the interest of transparency and brevity, we will not do so, but we do wish to point this issue out before proceeding further.

33.5.1 A Model with Short and Long Term Riskless Debt and Long Term Risky Debt

Suppose that there is a representative household who lives for three periods – t , $t + 1$, and $t + 2$. As above, assume for simplicity that the household earns an exogenous income stream. It is potentially unknown in $t + 1$ and $t + 2$ from the perspective of period t .

With its exogenous resource flow in t , the household can consume, save/borrow through one period government (riskless) debt, two period government (riskless) debt, or two period private (risky) debt. The flow budget constraint facing the household is:

$$C_t + P_{t,t,t+1}^B B_{t,t,t+1} + P_{t,t,t+2}^B B_{t,t,t+2} + PR_{t,t,t+2}^B BR_{t,t,t+2} \leq Y_t \quad (33.132)$$

$B_{t,t,t+1}$ denotes the stock of one period riskless bonds the household takes from t to $t + 1$. These bonds pay out one in $t + 1$ with certainty. $B_{t,t,t+2}$ is the stock of two period bonds the household purchases; if held to maturity, they pay out one with certainty in $t + 2$. $BR_{t,t,t+2}$ is the stock of private, risky bonds that the household purchases in t . If held until $t + 2$, these bonds either payout one or zero (i.e. the bond issuer defaults). We discuss the nature of default risk below. The prices of the three bonds are $P_{t,t,t+1}^B$, $P_{t,t,t+2}^B$, and $PR_{t,t,t+2}^B$.

Suppose that income in period $t + 1$ can be Y_{t+1}^h with probability p and $Y_{t+1}^l \leq Y_{t+1}^h$ with probability $1 - p$. Use an h or l subscript to denote high or low realizations in $t + 1$. A flow

budget constraint must hold in $t + 1$ regardless of the realization of uncertainty. The budget constraints are:

$$C_{t+1}^h + P_{t+1,t+1,t+2}^{B,h} B_{t+1,t+1,t+2}^h + P_{t+1,t,t+2}^{B,h} (B_{t+1,t,t+2}^h - B_{t,t,t+2}) + PR_{t+1,t,t+2}^{B,h} (BR_{t+1,t,t+2}^h - BR_{t,t,t+2}) \leq Y_{t+1}^h + B_{t,t,t+1} \quad (33.133)$$

$$C_{t+1}^l + P_{t+1,t+1,t+2}^{B,l} B_{t+1,t+1,t+2}^l + P_{t+1,t,t+2}^{B,l} (B_{t+1,t,t+2}^l - B_{t,t,t+2}) + PR_{t+1,t,t+2}^{B,l} (BR_{t+1,t,t+2}^l - BR_{t,t,t+2}) \leq Y_{t+1}^l + B_{t,t,t+1} \quad (33.134)$$

In $t + 1$, regardless of the state of nature, the household can consume, accumulate newly issued one period government bonds, or buy/sell previously issued two period government or private bonds. In period $t + 2$, assume once again that income can be high or low with the same probabilities p and $1 - p$, respectively. The realization of income in $t + 2$ is independent of the realization of income in $t + 1$. To make things as clean as possible, assume that the risky bond defaults with 100 percent probability if income is low in $t + 2$. Otherwise it generates one unit of income for the household. Because there are two possible states in $t + 2$ and two in $t + 1$, and what happens in $t + 1$ is potentially relevant for $t + 2$, there are effectively four possible states in $t + 2$. Denote these with (h, h) for example, where the first h denotes the $t + 2$ income state and the second entry corresponds to the state of nature in $t + 1$. In period $t + 2$, the household receives an exogenous income flow plus payouts from bonds held between $t + 1$ and $t + 2$. The four budget constraints that must hold are:

$$C_{t+2}^{h,h} \leq Y_{t+2}^h + B_{t+1,t+1,t+2}^h + B_{t+1,t,t+2}^h + BR_{t+1,t,t+2}^h \quad (33.135)$$

$$C_{t+2}^{h,l} \leq Y_{t+2}^h + B_{t+1,t+1,t+2}^l + B_{t+1,t,t+2}^l + BR_{t+1,t,t+2}^l \quad (33.136)$$

$$C_{t+2}^{l,l} \leq Y_{t+2}^l + B_{t+1,t+1,t+2}^l + B_{t+1,t,t+2}^l \quad (33.137)$$

$$C_{t+2}^{l,h} \leq Y_{t+2}^l + B_{t+1,t+1,t+2}^h + B_{t+1,t,t+2}^h \quad (33.138)$$

In (33.135)-(33.138), government bonds payout one with certainty regardless of whether income is high or low. The risky bond only pays if the household's endowment of income is high; otherwise it defaults and generates no income for the household. Hence, $BR_{t+1,t,t+2}$ does not appear in (33.137)-(33.138), which correspond to the low income state in $t + 2$.

Expected utility for the household is a discounted expected sum of flow utilities across

time and states of nature:

$$U = u(C_t) + \beta \left[pu(C_{t+1}^h) + (1-p)u(C_{t+1}^l) \right] + \beta^2 \left[p^2 u(C_{t+2}^{h,h}) + p(1-p)u(C_{t+2}^{h,l}) + (1-p)^2 u(C_{t+2}^{l,l}) + (1-p)pu(C_{t+2}^{l,h}) \right] \quad (33.139)$$

The household's objective is to maximize (33.139) subject to (33.132)-(33.138). It is once again easiest to transform this into an unconstrained problem of choosing bond holdings. Once one does so, the first order optimality conditions may be written:

$$B_{t,t,t+1} : P_{t,t,t+1}^B u'(C_t) = \beta \left[pu'(C_{t+1}^h) + (1-p)u'(C_{t+1}^l) \right] \quad (33.140)$$

$$B_{t,t,t+2} : P_{t,t,t+2}^B u'(C_t) = \beta \left[pP_{t+1,t,t+2}^{B,h} u'(C_{t+1}^h) + (1-p)P_{t+1,t,t+2}^{B,h} u'(C_{t+1}^l) \right] \quad (33.141)$$

$$BR_{t,t,t+2} : PR_{t,t,t+2}^B u'(C_t) = \beta \left[pPR_{t+1,t,t+2}^{B,h} u'(C_{t+1}^h) + (1-p)PR_{t+1,t,t+2}^{B,l} u'(C_{t+1}^l) \right] \quad (33.142)$$

$$B_{t+1,t+1,t+2}^h : \beta p P_{t+1,t+1,t+2}^h u'(C_{t+1}^h) = \beta^2 \left[p^2 u'(C_{t+2}^{h,h}) + p(1-p)u'(C_{t+2}^{h,l}) + (1-p)^2 u'(C_{t+2}^{l,l}) + (1-p)pu'(C_{t+2}^{l,h}) \right] \quad (33.143)$$

$$B_{t+1,t+1,t+2}^l : \beta(1-p)P_{t+1,t+1,t+2}^l u'(C_{t+1}^l) = \beta^2 \left[p^2 u'(C_{t+2}^{h,h}) + p(1-p)u'(C_{t+2}^{h,l}) + (1-p)^2 u'(C_{t+2}^{l,l}) + (1-p)pu'(C_{t+2}^{l,h}) \right] \quad (33.144)$$

$$B_{t+1,t,t+2}^h : \beta p P_{t+1,t,t+2}^h u'(C_{t+1}^h) = \beta^2 \left[p^2 u'(C_{t+2}^{h,h}) + p(1-p)u'(C_{t+2}^{h,l}) + (1-p)^2 u'(C_{t+2}^{l,l}) + (1-p)pu'(C_{t+2}^{l,h}) \right] \quad (33.145)$$

$$B_{t+1,t,t+2}^l : \beta(1-p)P_{t+1,t,t+2}^l u'(C_{t+1}^l) = \beta^2 \left[p^2 u'(C_{t+2}^{h,h}) + p(1-p)u'(C_{t+2}^{h,l}) + (1-p)^2 u'(C_{t+2}^{l,l}) + (1-p)pu'(C_{t+2}^{l,h}) \right] \quad (33.146)$$

$$BR_{t+1,t,t+2}^h : \beta p PR_{t+1,t,t+2}^h u'(C_{t+1}^h) = \beta^2 \left[p^2 u'(C_{t+2}^{h,h}) + p(1-p)u'(C_{t+2}^{h,l}) \right] \quad (33.147)$$

$$BR_{t+1,t,t+2}^l : \beta(1-p)PR_{t+1,t,t+2}^l u'(C_{t+1}^l) = \beta^2 \left[p^2 u'(C_{t+2}^{h,h}) + p(1-p)u'(C_{t+2}^{h,l}) \right] \quad (33.148)$$

In terms of expectations operators, (33.140)-(33.142) are simply:

$$P_{t,t,t+1}^B u'(C_t) = \beta \mathbb{E}[u'(C_{t+1})] \quad (33.149)$$

$$P_{t,t,t+2}^B u'(C_t) = \beta \mathbb{E}[P_{t+1,t,t+2}^B u'(C_{t+1})] \quad (33.150)$$

$$PR_{t,t,t+2}^B u'(C_t) = \beta \mathbb{E}[PR_{t+1,t,t+2}^B u'(C_{t+1})] \quad (33.151)$$

(33.149)-(33.151) have familiar intuitive interpretations based on work we have already done. In conjunction with the market-clearing condition that consumption equals income, these conditions determine the equilibrium bond prices. Via exactly the same arguments we made above, (33.149)-(33.150) can be combined and manipulated to relate the price of the two period riskless bond to the product of current and expected one period riskless bond prices with a term premium term:

$$P_{t,t,t+2}^B = P_{t,t,t+1}^B \mathbb{E}[P_{t+1,t+1,t+2}] \left(1 + \frac{\text{cov}(P_{t+1,t+1,t+2}^B, u'(Y_{t+1}))}{\mathbb{E}[P_{t+1,t+1,t+2}^B] \mathbb{E}[u'(Y_{t+1})]} \right) \quad (33.152)$$

To simplify notation, define the term in parentheses as TP_t and write (33.152) as:

$$P_{t,t,t+2}^B = P_{t,t,t+1}^B \mathbb{E}[P_{t+1,t+1,t+2}] TP_t \quad (33.153)$$

Next, turn to the pricing condition for the risky bond. In particular, combine (33.151) with (33.150) to get:

$$PR_{t,t,t+2}^B = P_{t,t,t+2}^B \frac{\mathbb{E}[PR_{t+1,t,t+2}^B u'(Y_{t+1})]}{\mathbb{E}[P_{t+1,t,t+2}^B u'(Y_{t+1})]} \quad (33.154)$$

From (33.154), we can see that the price of risky long term debt is related to the price of long term riskless debt and another term related to future prices of risky and riskless government debt. To simplify this other term, note that if one adds (33.143)-(33.144) together, imposes the market-clearing condition that consumption equals income, and notes that $P_{t+1,t,t+2}^B = P_{t+1,t+1,t+2}^B$ (i.e. the price of the riskless debt depends only on remaining time to maturity, not date of issuance) one gets:

$$\mathbb{E}[P_{t+1,t,t+2}^B u'(Y_{t+1})] = \beta \mathbb{E}[u'(Y_{t+2})] \quad (33.155)$$

We can do something similar for the denominator in (33.154). Define D_{t+2} as the payout on the risky bond in period $t+2$. As discussed above, $D_{t+2} = 1$ if $Y_{t+2} = Y_{t+2}^h$ and $D_{t+2} = 0$ if $Y_{t+2} = Y_{t+2}^l$. With this new notation, one can add (33.147)-(33.148) together to get the analog of (33.155):

$$\mathbb{E}[PR_{t+1,t,t+2}^B u'(Y_{t+1})] = \beta \mathbb{E}[D_{t+2} u'(Y_{t+2})] \quad (33.156)$$

Now substitute (33.156) and (33.155) into (33.154) to get:

$$PR_{t,t,t+2}^B = P_{t,t,t+2}^B \frac{\mathbb{E}[D_{t+2} u'(Y_{t+2})]}{\mathbb{E}[u'(Y_{t+2})]} \quad (33.157)$$

Multiply and divide the right hand side of (33.157) by $\mathbb{E}[D_{t+2}]$ to get:

$$PR_{t,t,t+2}^B = P_{t,t,t+2}^B \mathbb{E}[D_{t+2}] \frac{\mathbb{E}[D_{t+2} u'(Y_{t+2})]}{\mathbb{E}[D_{t+2}] \mathbb{E}[u'(Y_{t+2})]} \quad (33.158)$$

One would be tempted to distribute the expectations operator in the numerator and hence cancel out the fraction in (33.158), but as we have seen again and again, in general this is not possible. Rather, we can use the by-now-familiar relationship between covariance and expectations operators to write:

$$PR_{t,t,t+2}^B = P_{t,t,t+2}^B \mathbb{E}[D_{t+2}] \left(1 + \frac{\text{cov}(D_{t+2}, u'(Y_{t+2}))}{\mathbb{E}[D_{t+2}] \mathbb{E}[u'(Y_{t+2})]} \right) \quad (33.159)$$

In (33.159), the term $\left(1 + \frac{\text{cov}(D_{t+2}, u'(Y_{t+2}))}{\mathbb{E}[D_{t+2}] \mathbb{E}[u'(Y_{t+2})]} \right)$ is a risk premium. Given our assumptions, this covariance term is *negative*. When income is high in $t + 2$, $u'(Y_{t+2})$ is low and D_{t+2} is higher than average. Conversely, when income is low in $t + 2$, $u'(Y_{t+2})$ is higher than average and D_{t+2} is low. This negative covariance means that the term in parentheses is less than one and that the risky bond will trade at a discount compared to the two period riskless bond (equivalently, it will demand a higher yield). So as to economize on notation, define $RP_t = \left(1 + \frac{\text{cov}(D_{t+2}, u'(Y_{t+2}))}{\mathbb{E}[D_{t+2}] \mathbb{E}[u'(Y_{t+2})]} \right)$ and write:

$$PR_{t,t,t+2}^B = P_{t,t,t+2}^B \mathbb{E}[D_{t+2}] RP_t \quad (33.160)$$

(33.160) and (33.153) are the keys to understanding the transmission of monetary policy into the interest rates relevant for economic activity. The key point is that risky bond prices (yields) depend on longer maturity riskless bond prices (yields), which in turn depend on short term riskless bond prices (yields). Conventional monetary policy operates by increasing/decreasing the demand for short term riskless government bonds, and therefore impacting the price (yield) of such debt. Through (33.153) and (33.160), changes in the price (yield) of short run riskless debt filter through to the price (yield) on longer maturity risky debt, which is what is relevant for the decision-making of households and firms.

We can employ a simple graphical apparatus based on supply and demand curves to think about how the price (yield) of longer maturity risky debt is ultimately determined. Consider

Figure 33.14. Suppose that the supply of both short term and long term government debt are exogenously set by the (unmodeled) fiscal authority; hence the supply curves are vertical. There are downward-sloping demand curves for short term debt in both t and in expectation for $t + 1$ – i.e. the lower is the price (higher is the yield), the more the household would like to save, and hence the more bonds it wants to buy. The intersection of demand and supply determines $P_{t,t,t+1}^B$ and $\mathbb{E}[P_{t+1,t+1,t+2}^B]$.

Figure 33.14: The Markets for Short and Long Term Government Bonds

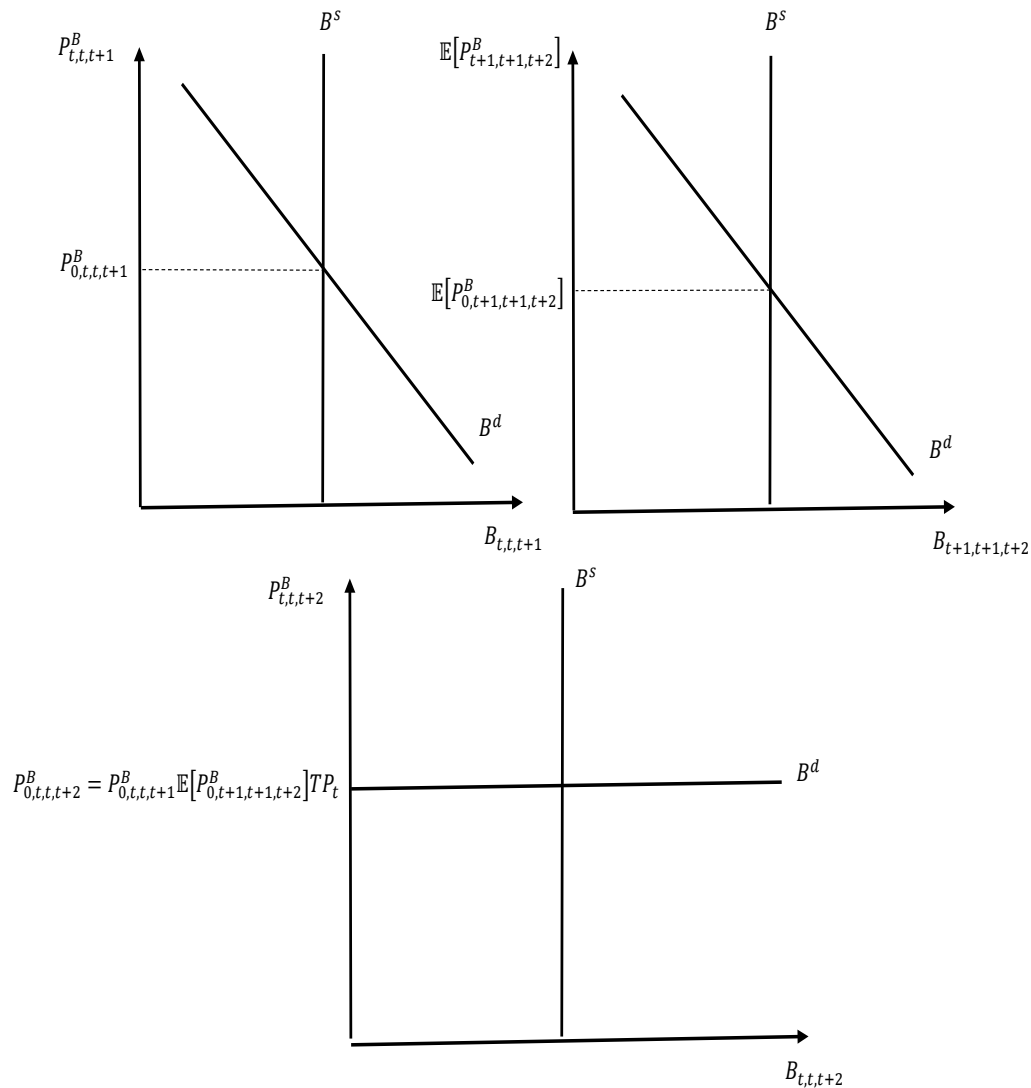

The demand and supply curves for short term riskless debt (in both the present and future) are shown in the upper part of Figure 33.14. The demand for long term riskless debt, shown in the bottom part of the figure, is slightly different. In particular, the demand for

long term debt is *perfectly elastic* at the price given in (33.153). If the price of long term debt were below this, there would be infinite demand for long run bonds – the household would like to buy long term bonds and finance them by borrowing via short term bonds. The reverse would be true if the price of long term debt were above this. As a consequence, the demand curve for long term debt is perfectly horizontal at (33.153). This price depends upon the equilibrium prices of short term government debt (both in t as well as in expectation in $t + 1$), determined in the upper part of Figure 33.14, along with the term premium, which we shall take as given.

Although we have not included production into our model, we can think about there being a representative firm that needs to finance its capital accumulation by issuing long term debt. The firm will want to do more investment, and hence issue more debt, the lower is the interest rate on that debt. Since the interest rate (yield) on debt is inversely related to the price of debt, we can think about there being an upward-sloping supply curve of risky debt. The higher is the price of such debt, the cheaper it is for the firm to raise funds, and hence the more such debt it supplies. This is shown in Figure 33.15 below.

Figure 33.15: The Market for Long Term Risky Bonds

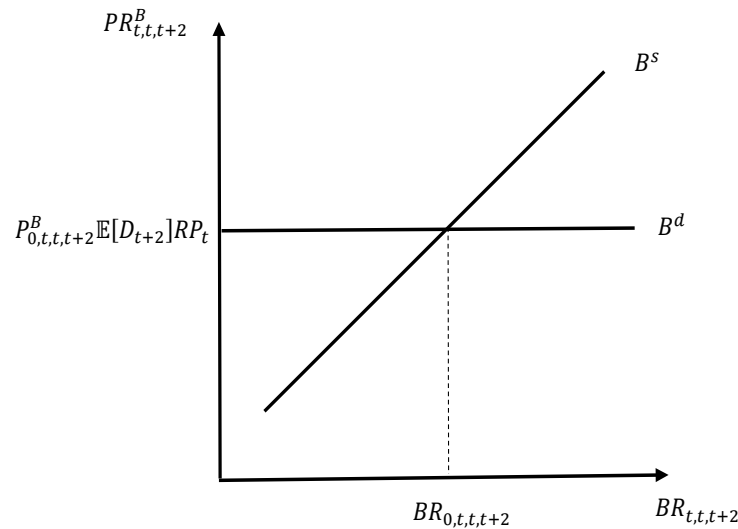

The demand curve for risky debt is determined by the household, who supplies savings by buying bonds. Like the demand curve for long term riskless debt, the demand curve for risky debt is *perfectly elastic* at the price given in (33.160). If the price of risky debt were greater than this, there would be infinite demand for such debt – the household would want to borrow through riskless debt and use the proceeds from that to purchase the risky debt.

As such, the demand curve must be horizontal at (33.160). The position of this demand curve depends upon the price (yield) of long term riskless debt, the expected payout on the bond, and the risk premium. Because changes in short term riskless bond prices influence long term riskless bond prices, changes in short term yields on government debt should filter through to the yield (price) on longer term risky debt.

33.5.2 Conventional Monetary Policy

We are now in a position to use these graphs to think about the conventional channels through which central banks impact the interest rates relevant for households and firms. As discussed in Chapter 31, when a central bank wishes to increase the money supply it conducts an open market purchase. In particular, it *buys* government debt and finances this purchase with the creation of reserves. The reserves can then filter through to the money supply through the usual multiple deposit creation channel. Conventional open market operations deal in short term government debt (i.e. T-Bills in the US).

When a central bank decides to conduct an open market purchase, it effectively *increases* the demand for short term bonds. This is shown in Figure 33.16. The increase in the demand for short term government debt pushes up the price of such debt (i.e. lowers the yield). This then translates into more demand, and hence a higher price, of long term government debt. This is shown in the lower panel of Figure 33.16.

Figure 33.16: Conventional Monetary Policy: Open Market Purchase

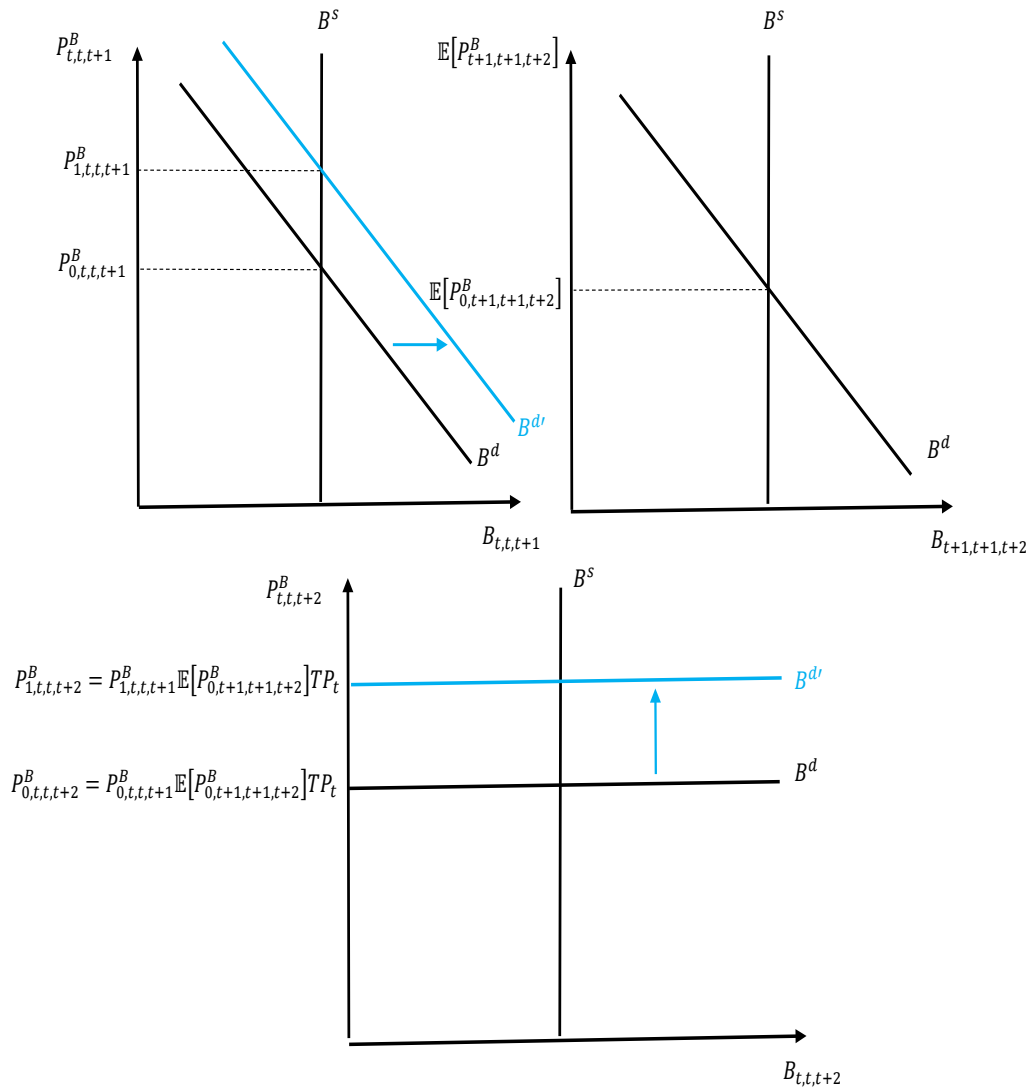

The higher price (lower yield) of long term government debt results in an increase in the demand for risky debt. Because $P_{t,t,t+2}^B$ is higher, the demand curve for risky bonds shifts up. This results in an increase in the price of risky debt and a decline in yield. The lower yield stimulates bond issuance and we move up the upward-sloping supply curve in Figure 33.17. As a consequence, there is more debt issuance and more investment.

Figure 33.17: Conventional Monetary Policy: Impact on Market for Risky Long Term Debt

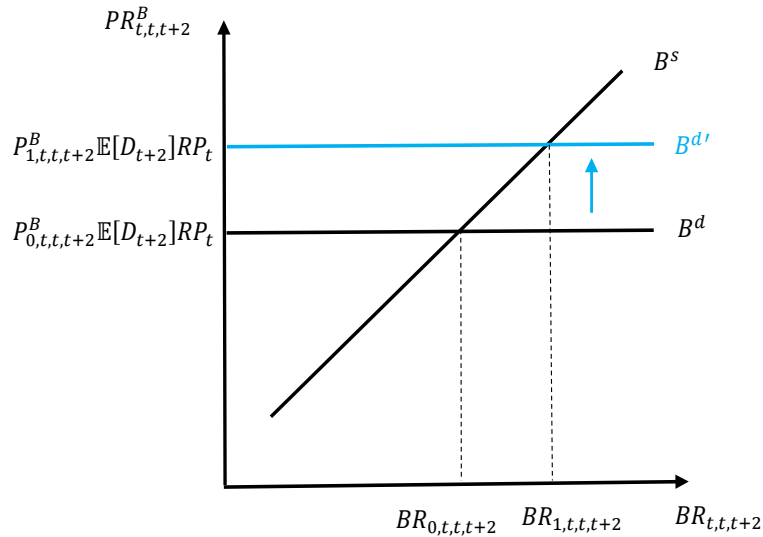

Figures 33.16 and 33.17 describe the ordinary, or conventional, workings of monetary policy. Open market sales work in the opposite direction, resulting in lower prices of risky bonds and consequently higher yields and less investment.

33.5.3 Unconventional Policy

The Federal Reserve in the US and other central banks around the world resorted to *unconventional* policies when the zero lower bound (ZLB) on nominal interest rates began to bind in late 2008. Although we have not explicitly incorporated or mentioned a ZLB constraint in the demand-supply graphs of this section, one could think about the demand for short term government debt becoming perfectly elastic (horizontal) at some upper bound, implying a lower bound on the yield on such debt. We show such a situation in Figure 33.18:

Figure 33.18: The Zero Lower Bound and the Market for Short Term Riskless Bonds

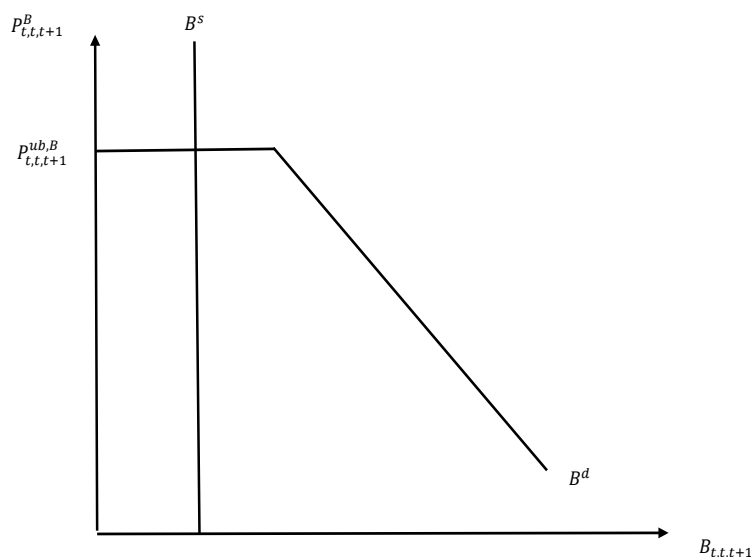

If the demand curve intersects the supply curve in the flat region of the demand curve, it is not possible to adjust the equilibrium yield on short term riskless debt through open market operations. Ultimately, however, short term riskless interest rates are not what is relevant for economic activity. Conventional monetary policy seeks to adjust such rates so as to influence longer term, risky interest rates. When the ZLB began to bind, the Federal Reserve and other central banks resorted to alternative policies designed to more *directly* influence the interest rates relevant for economic activity (whereas conventional monetary policy *indirectly* influences these rates because bonds of different characteristics are substitutes).

The two principal means of unconventional monetary policy were [forward guidance](#) and [quantitative easing](#) (also sometimes called large scale asset purchases, or LSAP). Forward guidance involves a central bank telegraphing its intentions for *future* short term interest rates. In the context of the model with which we have been working, it is easy to see why forward guidance might work. If long term risky yields depend on long term riskless yields, and long term riskless yields in turn depend on the current and expected sequence of short term yields, then promising lower *future* short term yields ought to result in lower long term yields in the present, which then ought to filter through to lower interest rates on risky debt. Of course, this will only work to the extent to which the public believes that the central bank will follow through on its promises, so credibility is important. Quantitative easing involves purchasing, in large amounts, non-traditional securities, such as longer term government debt or private-sector risky debt. The basic idea behind quantitative easing is straightforward – if one can increase the demand for these types of debt, one ought to be able to raise the

price of such debt, and hence lower the yield. While such logic seems straightforward and unassailable, quantitative easing *should not work* in the type of model we have laid out. We can see this above. Because long term bonds (either risky or otherwise) are substitutable with short term riskless bonds, the demand for long term bonds is perfectly elastic, and it should not be possible to influence the price (yield) of such debt without affecting either the sequence of short term yields or the risk or term premia.

Figures 33.19-33.20 use our graphical demand-supply analysis to think about how forward guidance might work. Credibly promising to increase the demand for short term debt in the future (right panel of upper row of Figure 33.19) ought to increase the expected price of such debt (equivalently, lower the anticipated yield). This should result in an immediate increase in the price of long term debt (lower panel of Figure 33.19). The increased price of long term riskless debt ought to translate into a higher price of risky long term debt (Figure 33.20). The lower yield on such debt ought to stimulate debt issuance and hence investment.

Figure 33.19: Unconventional Monetary Policy: Forward Guidance

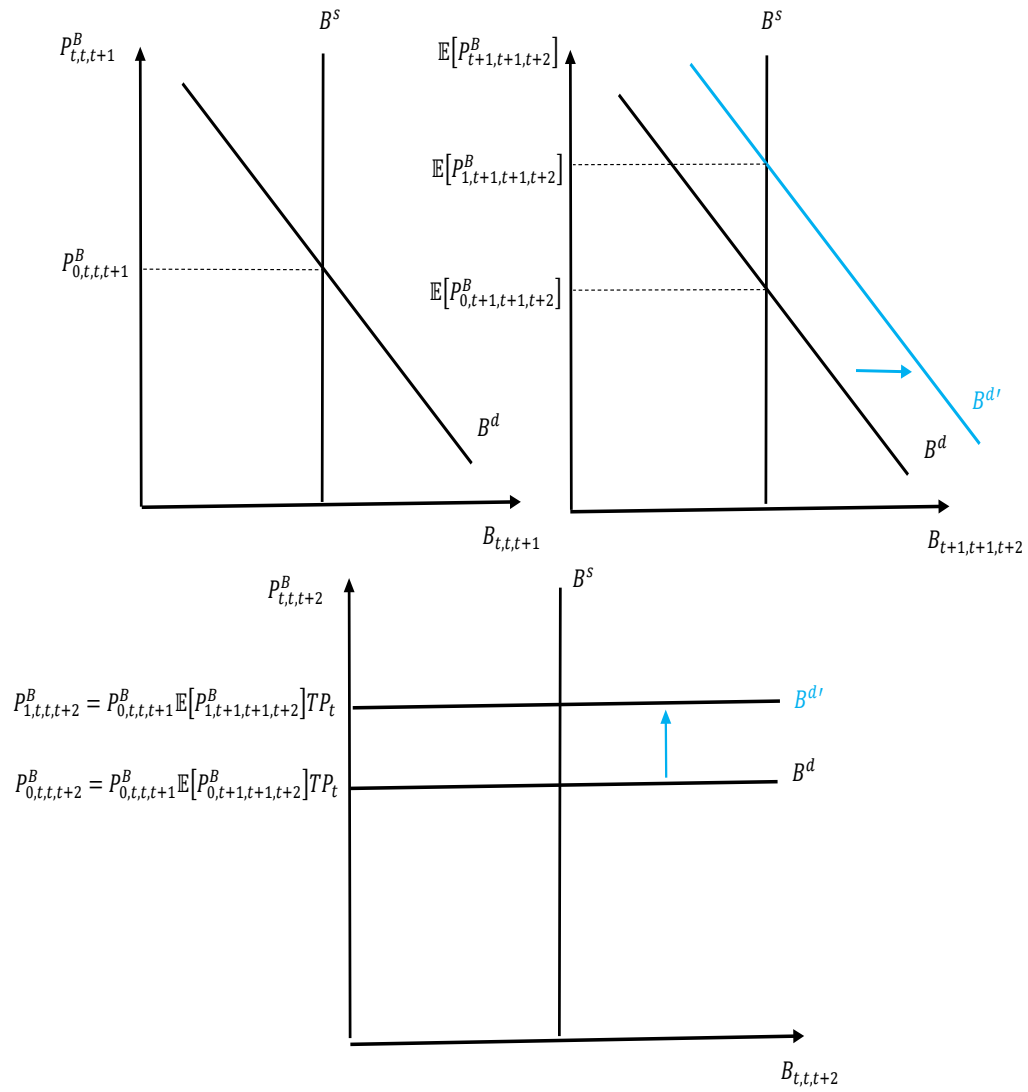
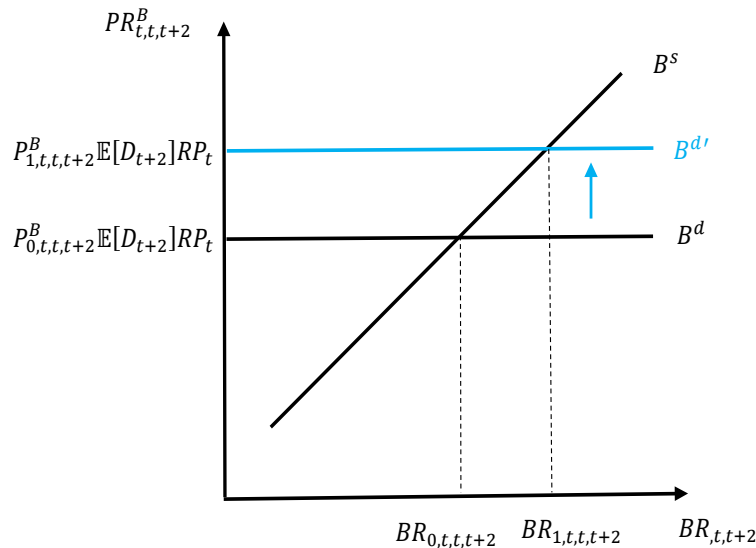

Figure 33.20: Forward Guidance and the Market for Risky Long Term Debt



In a sense, forward guidance in theory ought to work similarly to conventional policy. What is unconventional about it is that a central bank is hoping to alter expectations of *future* short term riskless yields rather than impacting current riskless yields. Quantitative easing is rather different. While it involves trying to purchase bonds, it involves either purchasing long maturity riskless debt or privately-issued risky debt. As noted above, the idea is that by increasing the demand for such debt, the prices should rise and yields should fall. But this logic ignores the fact that long term bonds (either risky or riskless) are substitutes with short term debt. This substitutability pins down the prices of long term debt via (33.151) or (33.160). Without any change in the current or expected sequence of short term, riskless bond yields, the only way to influence the prices of long term debt (either risky or riskless) would be to impact the term or risk premia. These terms depend on the *covariance* of bond prices with output, and it is not clear how or why large scale asset purchases ought to be able to impact them. Because of this, former Fed chairman Ben Bernanke famously quipped “The problem with quantitative easing is that it works in practice but not in theory.”

Quantitative easing in the US took two forms. In QE1 (Fall of 2008 throughout 2009) and QE3 (Fall of 2012 through 2014) the Fed purchased mortgage backed securities. In QE2 (November 2010), and at the tail end of QE1, the Fed also purchased longer maturity Treasury securities. In the context of the simple model we have laid out here, we can think about QE2 as trying to increase the demand for two period riskless debt, while QE1 and QE3 involved trying to increase the demand for private-issued risky debt.

Figures 33.21-33.22 use our graphical demand-supply analysis to think about quantitative easing involving government securities. Because the demand curve for long term debt is perfectly elastic, absent a change in the term premium there is no change in the price (yield) of long term riskless debt, and hence no change in the price (yield) of long term risky debt (Figure 33.22).

Figure 33.21: Unconventional Monetary Policy: Quantitative Easing, Government Securities

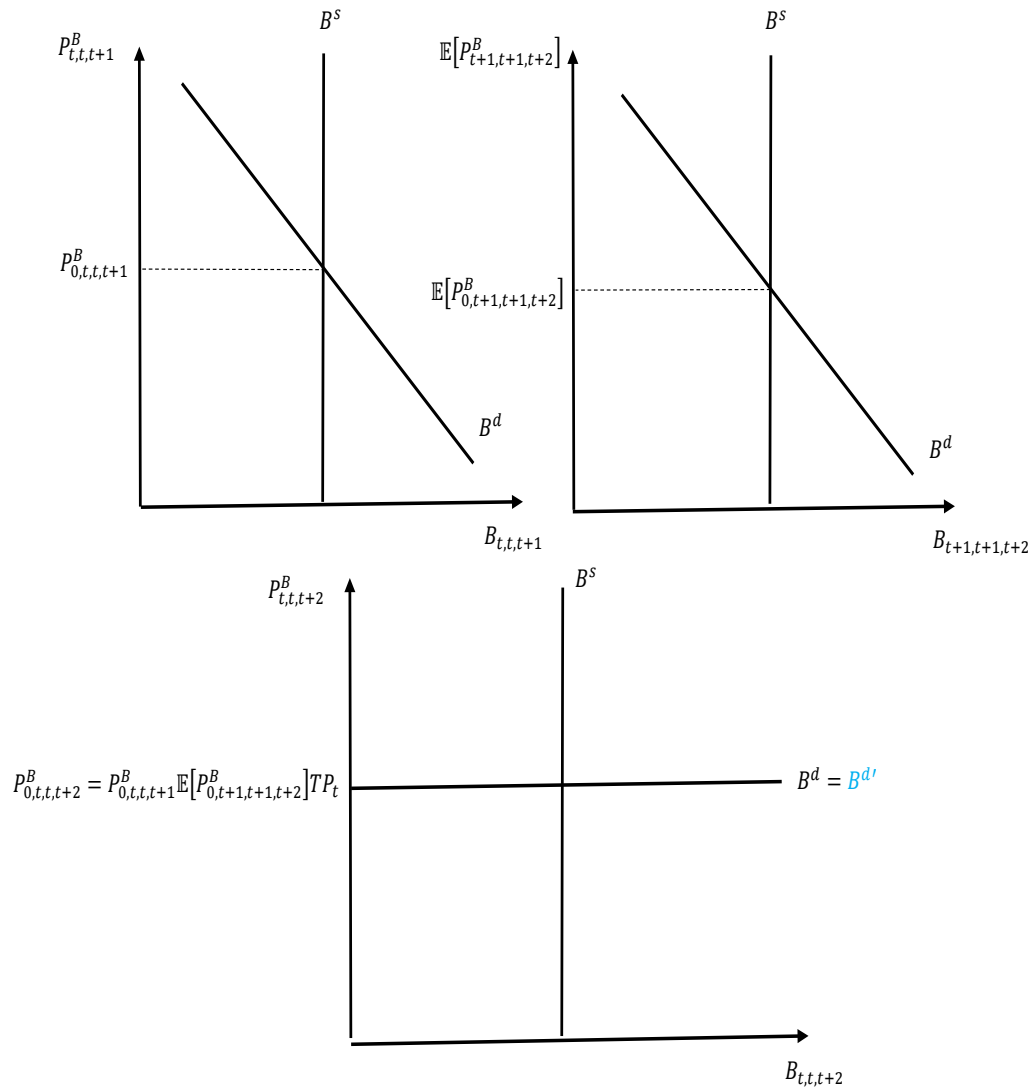

Figure 33.22: Quantitative Easing (Government Securities) and Market for Risky Long Term Debt

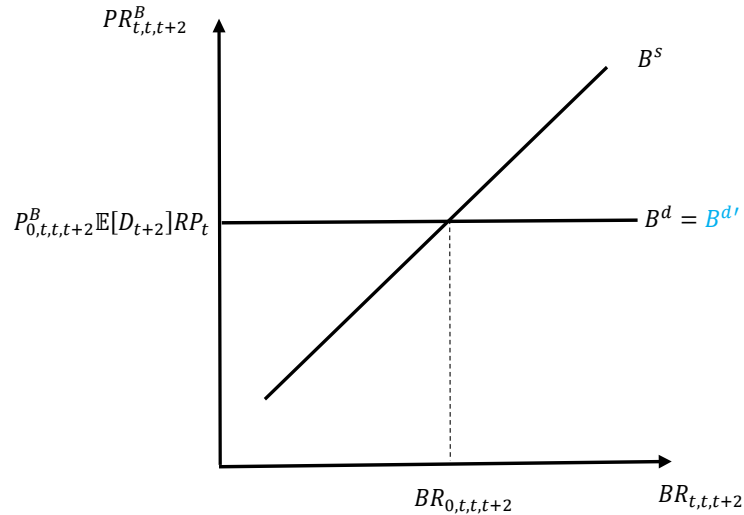
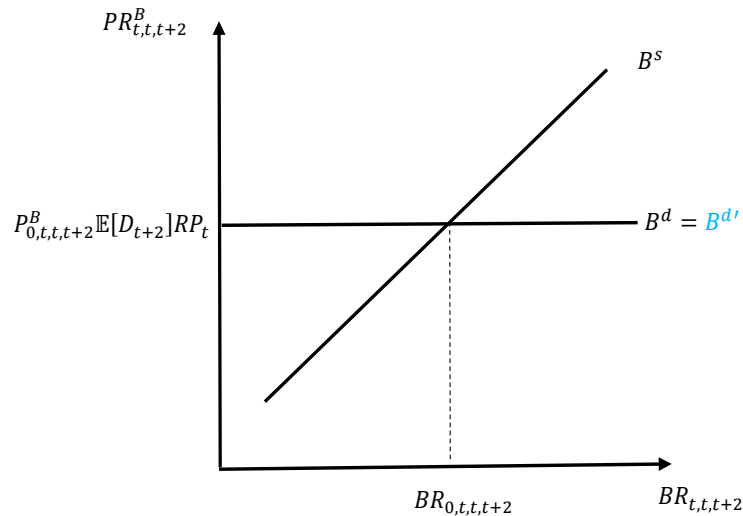

Figure 33.23 focuses on the market for privately-issued risky debt. Again, absent a change in the risk premium, it ought not to be possible to influence the price (yield) of risky debt by simply trying to buy more. In effect, a central bank stimulating demand for such debt ought to cause a reduction in household demand for such debt, which in equilibrium results in the price (yield) being unchanged.

Figure 33.23: Quantitative Easing (Risky Long Term Debt)



Under what theoretical conditions might quantitative easing work, as Ben Bernanke evidently believes it does in practice? What makes quantitative easing impotent in theory is that we have assumed that bonds of different characteristics are *perfect substitutes*. Once one controls for risk (i.e. the term and risk premia), bond yields must be equalized across different types of debt. A simple way to break this tight connection is to drop the assumption that bonds of different characteristics are perfectly substitutable. [Segmented markets theory](#) instead assumes that bonds of different characteristics are not substitutes at all. Some households prefer short term government debt but not the other two kinds of debt in our model; others are different. If this is the case, the demand curves for all different types of debt are downward-sloping and their prices (yields) are not intimately related. Increasing the demand for one kind of debt has no impact on the demands for other types of debt.

The astute reader may note that the Federal Reserve was in essence hedging its bets in deploying *both* forward guidance and quantitative easing as unconventional policies. Under our standard theory laid out in this chapter, forward guidance (if credibly done) ought to be successful in influencing economically relevant interest rates, but quantitative easing should not. Under segmented markets, quantitative easing could work in theory, but forward guidance should not be able to work. Why? If bonds of different types are not substitutes, then the price (yield) of risky debt is unrelated to the price (yield) of riskless debt, and promising low interest rates on short term riskless debt into the far off future should not have any impact on yields on risky debt.

33.6 Summary

- A bond is a type of security which entitles the holder to periodic cash flows until maturity. Bonds differ in their time to maturity, default risk, and cash flow payments.
- Interest rates on bonds are defined implicitly. The most common measure of interest rates on bonds is the yield to maturity (YTM). The YTM is the interest rate that equates the price of the bond to the expected present discounted value of cashflows coming from the bond.
- There is an inverse relationship between a bond's yield and its price.
- We can formalize bond pricing within the context of a two-period general equilibrium model in an endowment economy. If bonds are in zero net supply, bond prices adjust so that households always consume their endowment in equilibrium.
- The existence and size of the risk premium depend on how payments from a risky bond covary with future income. If the bond payments are comparatively low when future resources are low, then the risky bond will need to pay a premium.
- Empirical measures of the risk premium show that it is positive and, if anything, increasing over time.
- Yields on long maturity debt are almost always higher than yields on short maturity debt. The exception is the time immediately prior to a recession where the yield curve flattens or even inverts.
- Decisions by households and corporations are often made on the basis of long term, risky yields. Conventional monetary policy involves buying and selling risk free, short run bonds. Through a term structure channel, the purchase of the short run riskless bonds can affect the yields on longer maturity and riskier bonds.
- Unconventional monetary policy can take the form of forward guidance, where the monetary policy maker signals its intentions over future short run interest rates, or quantitative easing, where the monetary policy maker purchases longer term and/or riskier bonds. Under our benchmark theory, only the former should influence yields on longer maturity debt.

Key Terms

1. Bond

2. Maturity date
3. Default risk
4. Interest rate risk
5. Yield
6. Risk structure
7. Term structure
8. Discount bond
9. Coupon bond
10. Perpetuity bond
11. Expectations hypothesis
12. Interest rate risk
13. Forward guidance
14. Quantitative easing
15. Segmented markets theory

Questions for Review

1. Why is it more common to refer to a bond's yield rather than its price?
2. Does the coupon rate always equal a bond's yield to maturity? Explain.
3. True or false: All risky bonds pay a premium relative to risk free bonds. Explain.
4. Discuss what the expectations hypothesis gets right and what it gets wrong.
5. Explain the transmission mechanism of conventional monetary policy.
6. Under what circumstances will forward guidance be effective? Under what circumstances will quantitative easing be effective?

Chapter 34

The Stock Market and Bubbles

A stock is a type of financial security that is sometimes called an equity. It is called an equity because an owner of a share of stock is an owner in the company issuing the stock. Shareholders are entitled to the current and future profits generated by the company. Like bonds, which are discussed in Chapter 33, a share of stock entitles the holder of the stock to periodic cash flows. These cash flows are called *dividends* and constitute distributed profits to the owners of a company. As with most bonds, there is a highly liquid and active secondary market for shares of stock, so the holder of a share of stock can trade his/her shares.

There are a couple of important differences between stocks and bonds, all of which generally make stocks riskier than bonds. First, in the event of a company's failure, stockholders are *junior* claimants on the company's assets – they only get their funds back after all debt holders have been paid. This exposes stockholders to more risk than bondholders in the event of a company's failure. Secondly, whereas bonds offer known cash flows in the form of coupon payments and/or face value repayments (outside of default), the periodic cash flows from stocks are unknown. Dividends can vary substantially, and are often quite procyclical – i.e. dividends are comparatively high when the economy is booming and low otherwise. This co-movement is undesirable from the perspective of a household wishing to smooth its consumption. Third, whereas bonds typically have finite maturities (and many types of bonds are very short maturity), stocks have no maturity. This makes them inherently riskier than bonds. For example, suppose that a household that is 55 years old wishes to save for retirement at 65. By matching maturity to the investment horizon (i.e. purchasing ten year bonds), a household can lock in an expected return by investing in bonds (assuming no default risk). This is not possible for stocks.

For all these reasons, stocks are generally thought to be riskier than bonds. Because of this heightened risk, stocks trade at a higher average rate of return than do short term riskless government bonds. Figure 34.1 below plots the *equity premium*, which we define as the difference between the realized one year return on the S&P 500 less the realized one year return on three month Treasury Bills. On average, the equity premium so defined is between 6 and 7 percent and is quite volatile.

Figure 34.1: The Equity Premium

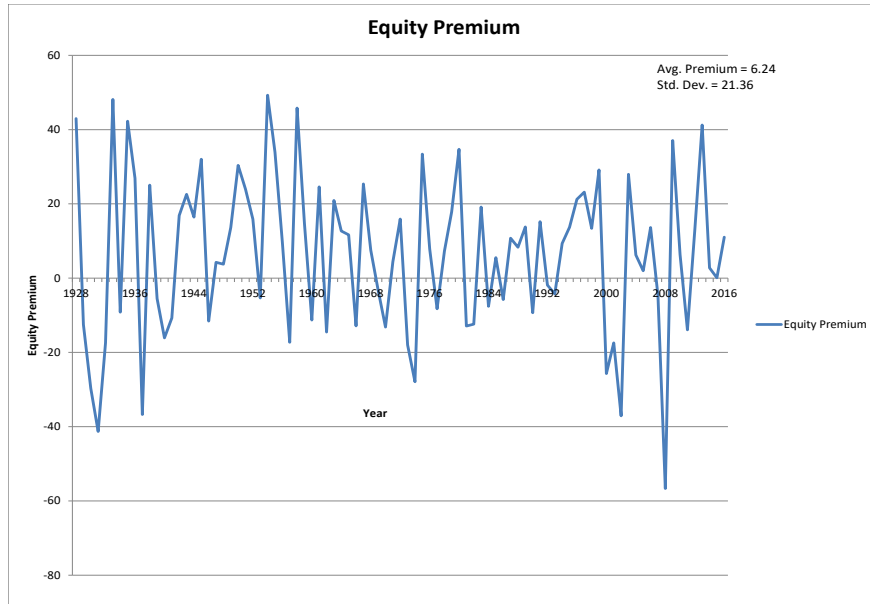
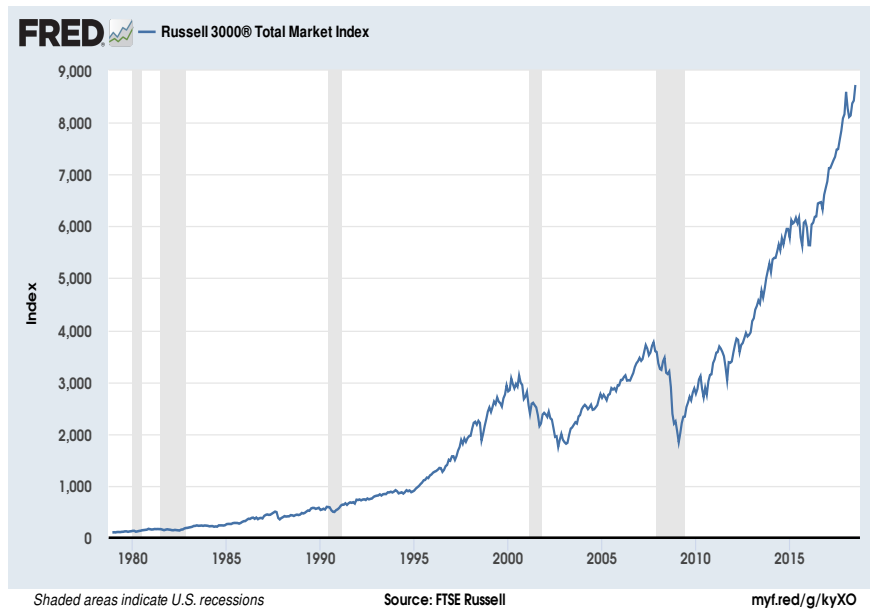

Figure 34.2 plots the time series of the [Russell 3000](#), which is a total US stock market price index. The aggregate stock market has risen steadily over time, though it tends to perform poorly during periods identified as recessions.

Figure 34.2: Total Stock Market Price Index



In this chapter, we build off the work from Chapter 33 to think about how stocks ought to be priced in equilibrium and how stock returns ought to compare to bond returns. We will also discuss the possibility of stock market “bubbles.” We will work within the confines

of a multi-period representative agent framework where in equilibrium no financial assets are held. We begin by focusing on two periods before extending the analysis to more than two periods. We conclude the chapter by returning to the equilibrium neoclassical model with production (laid out in detail in Chapter 12 to discuss how one would the stock market value of the representative firm should evolve in the context of that model.

34.1 Equity Pricing in a Two Period General Equilibrium Model

As in Chapter 33, we wish to incorporate stock pricing into a multi-period general equilibrium framework. We will again do so in an endowment economy model in which the representative household receives an exogenous income flow in each period. We again assume (for simplicity) that the household begins life with no stock of wealth. We explicitly allow for uncertainty over the future. We begin by focusing just on two periods, later extending the analysis to more than two periods (and in principle an infinite number of periods).

In period t , the representative household earns an exogenous and known income stream, Y_t . With that it can consume, C_t , or purchase one of two financial assets. The first is a one period, risk-free, discount bond. We will denote the quantity of this bond as B_t and its price as P_t^B . It is risk-free in the sense that the bond pays out its face value of 1 in period $t + 1$ with certainty. The second issue is a share of stock in a firm, SH_t . These shares trade at price Q_t in period t . Shares of stock held in period t entitles the owner to a dividend payout of d_{t+1} per share in period $t + 1$. This dividend payout is not known with certainty in period t .

The household's period t flow budget constraint is:

$$C_t + P_t^B B_t + Q_t SH_t \leq Y_t \quad (34.1)$$

In period $t + 1$, there are two sources of uncertainty. First, the endowment of income in period $t + 1$ can either be high or low, with $Y_{t+1}^h \geq Y_{t+1}^l$. Second, let us assume that the dividend payout on the stock can be high or low, with $d_{t+1}^h \geq d_{t+1}^l$. This means that there are four states of the world in $t + 1$ – think of these as (Y_{t+1}^h, d_{t+1}^h) , (Y_{t+1}^h, d_{t+1}^l) , (Y_{t+1}^l, d_{t+1}^h) , and (Y_{t+1}^l, d_{t+1}^l) . The period $t + 1$ flow budget constraint must hold in all four states of the world. We will use double superscripts to denote the state of the world in $t + 1$ – (h, h) refers to both income and the dividend by high, whereas (h, l) refers to income being high and the dividend being low, and so on. These constraints are:

$$C_{t+1}^{h,h} + P_{t+1}^{B,h,h} B_{t+1}^{h,h} + Q_{t+1}^{h,h} (SH_{t+1}^{h,h} - SH_{t+1}) \leq Y_{t+1}^h + B_t + d_{t+1}^h SH_t \quad (34.2)$$

$$C_{t+1}^{h,l} + P_{t+1}^{B,h,l} B_{t+1}^{h,l} + Q_{t+1}^{h,l} (SH_{t+1}^{h,l} - SH_{t+1}) \leq Y_{t+1}^h + B_t + d_{t+1}^l SH_t \quad (34.3)$$

$$C_{t+1}^{l,l} + P_{t+1}^{B,l,l} B_{t+1}^{l,l} + Q_{t+1}^{l,l} (SH_{t+1}^{l,l} - SH_{t+1}) \leq Y_{t+1}^l + B_t + d_{t+1}^l SH_t \quad (34.4)$$

$$C_{t+1}^{l,h} + P_{t+1}^{B,l,h} B_{t+1}^{l,h} + Q_{t+1}^{l,h} (SH_{t+1}^{l,h} - SH_{t+1}) \leq Y_{t+1}^l + B_t + d_{t+1}^h SH_t \quad (34.5)$$

Resources available to the household in period $t + 1$ include the exogenous income flow, payouts on one period discount bonds brought from t to $t + 1$, and dividends received on shares of stock brought from t to $t + 1$. With these resources, the household can consume, purchase/sell new one period discount bonds, or change its stock of equity holdings. Since the household ceases to exist after $t + 1$, it will not choose to die with any positive stock of bonds or stock in any state of the world, and it may not die with negative stocks of these variables. Imposing these terminal conditions, the period $t + 1$ budget constraints may be written:

$$C_{t+1}^{h,h} \leq Y_{t+1}^h + B_t + (d_{t+1}^h + Q_{t+1}^{h,h}) SH_t \quad (34.6)$$

$$C_{t+1}^{h,l} \leq Y_{t+1}^h + B_t + (d_{t+1}^l + Q_{t+1}^{h,l}) SH_t \quad (34.7)$$

$$C_{t+1}^{l,l} \leq Y_{t+1}^l + B_t + (d_{t+1}^l + Q_{t+1}^{l,l}) SH_t \quad (34.8)$$

$$C_{t+1}^{l,h} \leq Y_{t+1}^l + B_t + (d_{t+1}^h + Q_{t+1}^{l,h}) SH_t \quad (34.9)$$

There are two potential sources of income from holding shares of stock, S_t . First, the stock makes a dividend payment in period $t + 1$, either d_{t+1}^h or d_{t+1}^l . Second, in principle one might be able to sell the stock for a price Q_{t+1} that depends on the realization of the state. We will say more about Q_{t+1} shortly. It is common to refer to these two components of the payout to a stock as the “dividend” component and the “capital gain” component, respectively.

Now let us address the nature of uncertainty facing the household. Let p_1 be the probability of the first state occurring in $t + 1$ (both income and the dividend are high), p_2 be the probability of the second state (income is high, but the dividend is low), p_3 be the probability of the third state (income is low and the dividend is low), and $p_4 = 1 - p_1 - p_2 - p_3$ be the probability of the final state (income is low but the dividend is high). Period $t + 1$ consumption will depend on the realization of the state. We can write expected lifetime utility as:

$$U = u(C_t) + p_1 \beta u(C_{t+1}^{h,h}) + p_2 \beta u(C_{t+1}^{h,l}) + p_3 \beta u(C_{t+1}^{l,l}) + (1 - p_1 - p_2 - p_3) \beta u(C_{t+1}^{l,h}) \quad (34.10)$$

The household’s objective is to pick a consumption plan which maximizes (34.10) subject to (34.1) and (34.6)-(34.9). It is easiest to write the problem by eliminating the consumption

terms and instead think about the household as just picking B_t and SH_t in period t . Doing so yields the following unconstrained problem:

$$\begin{aligned} \max_{B_t, SH_t} U = & u[Y_t - P_t^B B_t - Q_t SH_t] + p_1 \beta u[Y_{t+1}^h + B_t + (d_{t+1}^h + Q_{t+1}^{h,h}) SH_t] + p_2 \beta u[Y_{t+1}^h + B_t + (d_{t+1}^l + Q_{t+1}^{h,l}) SH_t] + \\ & p_3 \beta u[Y_{t+1}^l + B_t + (d_{t+1}^l + Q_{t+1}^{l,l}) SH_t] + (1 - p_1 - p_2 - p_3) u[Y_{t+1}^l + B_t + (d_{t+1}^h + Q_{t+1}^{l,h}) SH_t] \end{aligned} \quad (34.11)$$

The first order conditions are:

$$\frac{\partial U}{\partial B_t} = 0 \Leftrightarrow P_t^B u'(C_t) = p_1 \beta u'(C_{t+1}^{h,h}) + p_2 \beta u'(C_{t+1}^{h,l}) + p_3 \beta u'(C_{t+1}^{l,l}) + (1 - p_1 - p_2 - p_3) \beta u'(C_{t+1}^{l,h}) \quad (34.12)$$

$$\begin{aligned} \frac{\partial U}{\partial SH_t} = 0 \Leftrightarrow Q_t u'(C_t) = & p_1 (d_{t+1}^h + Q_{t+1}^{h,h}) \beta u'(C_{t+1}^{h,h}) + p_2 (d_{t+1}^l + Q_{t+1}^{h,l}) \beta u'(C_{t+1}^{h,l}) + \\ & p_3 (d_{t+1}^l + Q_{t+1}^{l,l}) \beta u'(C_{t+1}^{l,l}) + (1 - p_1 - p_2 - p_3) (d_{t+1}^h + Q_{t+1}^{l,h}) \beta u'(C_{t+1}^{l,h}) \end{aligned} \quad (34.13)$$

(34.12)-(34.13) can be re-written in terms of expectations operators, since the right hand side of (34.12) is the expected value of the future marginal utility of consumption, while the right hand side of (34.13) is the expected value of the product of the future dividend with the future marginal utility of consumption.

$$P_t^B u'(C_t) = \beta \mathbb{E}[u'(C_{t+1})] \quad (34.14)$$

$$Q_t u'(C_t) = \beta \mathbb{E}[(d_{t+1} + Q_{t+1})u'(C_{t+1})] \quad (34.15)$$

Both (34.14) and (34.15) have intuitive marginal benefit equals marginal cost interpretations. Purchasing an additional unit of the risk-free bond in t entails foregoing P_t^B units of consumption in that period, which is valued in terms of utility at $u'(C_t)$. Hence, $P_t^B u'(C_t)$ is the marginal utility cost of purchasing an additional unit of the bond. The marginal utility benefit of purchasing an additional bond in t is an additional unit of income in $t + 1$, which is valued at $\beta \mathbb{E}[u'(C_{t+1})]$ (i.e. the expected marginal utility of consumption). Hence, the right hand side of (34.14) is the marginal utility benefit of purchasing an additional unit of the bond. At an optimum, the marginal utility benefit and cost must equal if the household is behaving optimally.

The intuitive interpretation for why (34.15) must also hold is similar. Purchasing one unit of stock costs Q_t units of consumption in period t , which is valued in terms of utility

at $u'(C_t)$. Hence, $Q_t u'(C_t)$ is the marginal utility cost of purchasing stock. The benefit of purchasing stock is the dividend to which the owner is entitled in $t + 1$ plus the share price of the stock in that period. This payout (dividend plus capital gain) is valued at the marginal utility of future consumption. In evaluating (34.15), it is important to note that $\mathbb{E}[(d_{t+1} + Q_{t+1})u'(C_{t+1})] \neq \mathbb{E}[(d_{t+1} + Q_{t+1})] \mathbb{E}[u'(C_{t+1})]$ in general, as we shall see below.

Both (34.14) and (34.15) can be written in such a way as to isolate the price of the asset on the left hand side. In so doing, we note that since $u'(C_t)$ is known in period t , it can be moved “inside” the expectation operator on the right hand side or placed on the outside. The same thing holds true for β , which is a constant parameter. Doing so yields:

$$P_t^B = \mathbb{E} \left[\beta \frac{u'(C_{t+1})}{u'(C_t)} \right] \quad (34.16)$$

$$Q_t = \mathbb{E} \left[\beta \frac{u'(C_{t+1})}{u'(C_t)} (d_{t+1} + Q_{t+1}) \right] \quad (34.17)$$

In both (34.16) and (34.17), the price of the asset under consideration equals the expected value of the product of the cash flows generated by the asset in question in $t + 1$ (1 for the risk-free bond, and $(d_{t+1} + Q_{t+1})$ for the equity) with the term $\beta \frac{u'(C_{t+1})}{u'(C_t)}$, which is also known as the stochastic discount factor. For either the stock or the bond, the basic interpretation of the pricing condition is the same.

We can define the (gross) expected yield on each kind of asset (i.e. the expected rate of return) as the expected cash flow generated by the asset in period $t + 1$ divided by the price paid for the asset in period t . Let r_t be the yield on the bond, and $r_{s,t}$ the yield on the stock. We get:

$$1 + r_t = \frac{1}{P_t^B} = \frac{1}{\mathbb{E} \left[\beta \frac{u'(C_{t+1})}{u'(C_t)} \right]} \quad (34.18)$$

$$1 + r_{s,t} = \frac{\mathbb{E}(d_{t+1} + Q_{t+1})}{Q_t} = \frac{\mathbb{E}(d_{t+1} + Q_{t+1})}{\mathbb{E} \left[\beta \frac{u'(C_{t+1})}{u'(C_t)} (d_{t+1} + Q_{t+1}) \right]} \quad (34.19)$$

The ratio of (gross) yields, which is approximately equal to one plus the difference between net yields, is:

$$\frac{1 + r_{s,t}}{1 + r_t} = \frac{\mathbb{E}(d_{t+1} + Q_{t+1}) \mathbb{E} \left[\beta \frac{u'(C_{t+1})}{u'(C_t)} \right]}{\mathbb{E} \left[(d_{t+1} + Q_{t+1}) \beta \frac{u'(C_{t+1})}{u'(C_t)} \right]} \quad (34.20)$$

One is tempted to look at (34.20) and conclude that the ratio of gross yields is 1, meaning $r_{s,t} = r_t$ – i.e. the expected return on both the stock and the bond are the same. Indeed,

one might naturally expect an outcome such as this. From the household's perspective, the bond and the stock are substitutes – they are both means by which to transfer resources intertemporally. If they are *perfect* substitutes, then in any equilibrium we would expect the expected returns to be equalized.

But it turns out, that, in general, the stock and the bond are *not* perfect substitutes. While both securities are means by which to transfer resources intertemporally, they differ in an important way. In particular, the bond generates one unit of income in period $t + 1$ *with certainty*. The share of stock, in contrast, generates an *uncertain* level of income in the future. To the extent to which the representative household dislikes such uncertainty, one might expect the household to demand compensation, in the form of a higher expected yield, to hold the risky asset.

As it turns out, it is not uncertainty *per se* that might result in stocks offering higher expected returns than risk-free bonds, but rather a particular form of uncertainty. In particular, the extent to which the expected yield for the stock differs from the bond depends on how the payout from the stock co-varies with $u'(C_{t+1})$. For the stock payout to co-vary with $u'(C_{t+1})$, the stock payout (as well as endowment income) must be uncertain. But this is only necessary, not sufficient, for stocks to have a different yield than bonds.

As was previously discussed in Chapter 33, for two random variables X and Y , $\mathbb{E}(XY) \neq \mathbb{E}(X)\mathbb{E}(Y)$. In fact, one can show that $\mathbb{E}(XY) = \mathbb{E}(X)\mathbb{E}(Y) + cov(X, Y)$. Only if X and Y are uncorrelated is the expectation of a product, i.e. $\mathbb{E}(XY)$, equal to the product of the expected values, i.e. $\mathbb{E}(X)\mathbb{E}(Y)$. In this particular example, we can think about X as being the stochastic discount factor, $\beta \frac{u'(C_{t+1})}{u'(C_t)}$, and Y as the cash flow from holding the stock, $d_{t+1} + Q_{t+1}$. Only when the cash flow from holding the stock is *uncorrelated* with the stochastic discount factor will the risk-free bond and the stock have the same expected return.

It is most reasonable to think that the cash flow from the stock will be *negatively* correlated with the stochastic discount factor. In particular, it stands to reason that when dividends and stock prices are relatively high, so $d_{t+1} + Q_{t+1}$ is relatively high, consumption will also be high, so that $u'(C_{t+1})$ will be low. If the cash flow from the stock and the stochastic discount factor are negatively correlated, then $\mathbb{E}\left[(d_{t+1} + Q_{t+1})\beta \frac{u'(C_{t+1})}{u'(C_t)}\right] < E(d_{t+1} + Q_{t+1})\mathbb{E}\left[\beta \frac{u'(C_{t+1})}{u'(C_t)}\right]$, and from (34.20) we should expect $r_{s,t} > r_t$. In other words, we should expect the stock to deliver a higher expected return than the bond. We will refer to this excess return of equity over a risk-free bond, $r_{s,t} - r_t$, as the *equity premium*.

Having derived the optimality conditions and introduced some new terminology, we are now in a position to apply a market-clearing concept to solve for equilibrium prices and yields on both the bond and the stock. As in Chapter 33, we are assuming that both the stock and the bond are in zero net supply (more generally assuming *fixed* but non-zero supply

would yield identical results). This means that, in equilibrium, $B_t = 0$ and $SH_t = 0$, so $C_t = Y_t$. Furthermore, we can conclude that $Q_{t+1} = 0$ regardless of the realization of the state of nature in $t + 1$. Why is this? The stock is a claim on *future* cash flows. But from the perspective of $t + 1$, there is no future, and so the asset ought to be worthless. This is a kind of terminal condition in its own right which is related to “bubbles,” and we shall return to it more below. Imposing these conditions, we arrive at expressions for equilibrium prices and yields of:

$$P_t = \mathbb{E} \left[\beta \frac{u'(Y_{t+1})}{u'(Y_t)} \right] \quad (34.21)$$

$$Q_t = \mathbb{E} \left[\beta \frac{u'(Y_{t+1})}{u'(Y_t)} d_{t+1} \right] \quad (34.22)$$

$$1 + r_t = \mathbb{E} \left[\beta \frac{u'(Y_{t+1})}{u'(Y_t)} \right]^{-1} \quad (34.23)$$

$$1 + r_{s,t} = \mathbb{E}[d_{t+1}] \left[\mathbb{E} \left[\beta \frac{u'(Y_{t+1})}{u'(Y_t)} d_{t+1} \right] \right]^{-1} \quad (34.24)$$

We are now in a position to give some values for future output, the future dividend, and the probabilities of future states, and then use those numbers to obtain numeric values for the prices of both assets as well as their relative yields (i.e. the equity premium). We do so in Table 34.1.

Table 34.1: Uncertainty and the Equity Premium

Probabilities	$\mathbb{E}(d_{t+1})$	$\mathbb{E}(d_{t+1} Y_{t+1}^h)$	$\mathbb{E}(d_{t+1} Y_{t+1}^l)$	P_t	Q_t	$r_{s,t} - r_t$
<u>$d_{t+1}^h = 1.5, d_{t+1}^l = 0.5$</u>						
$p_1 = p_3 = 0.5, p_2 = p_4 = 0.5$	1	1.5	0.5	0.959	0.912	0.055
$p_1 = p_2 = p_3 = p_4 = 0.25$	1	1	1	0.959	0.959	0
$p_1 = p_3 = 0.4, p_2 = p_4 = 0.1$	1	1.3	0.7	0.959	0.931	0.032
$p_1 = p_3 = 0.2, p_2 = p_4 = 0.3$	1	0.9	1.1	0.959	0.969	-0.010
<u>$d_{t+1}^h = 3, d_{t+1}^l = 1$</u>						
$p_1 = p_3 = 0.5, p_2 = p_4 = 0.5$	2	3	1	0.959	1.823	0.055
$p_1 = p_2 = p_3 = p_4 = 0.25$	2	2	2	0.959	0.959	0
$p_1 = p_3 = 0.4, p_2 = p_4 = 0.1$	2	2.6	1.4	0.959	1.862	0.032
$p_1 = p_3 = 0.2, p_2 = p_4 = 0.3$	2	1.8	2.2	0.959	1.938	-0.010

For all entries in the table, we suppose that $Y_t = 1$, $\beta = 0.95$, $Y_{t+1}^h = 1.1$, and $Y_{t+1}^l = 0.9$. Probabilities are always such that the expected value of future income is one, $\mathbb{E}(Y_{t+1}) = 1$. We first consider a case where the dividend payout is 1.5 in the high state and 0.5 in the low

state; probabilities are restricted such that the expected dividend payout is always one.

The first row considers the case where there is a 50 percent chance income is high and a 50 percent it is low. The dividend payout is perfectly positively correlated with income – the dividend is high when income is high and low when income is low. In this case, the price of the bond is 0.959 and the price of the stock is 0.931. The equity premium (difference in yields on the two assets) works out to 0.055, or about 5.5 percent. In other words, the household demands a 5.5 percent premium in the expected return to be willing to be indifferent between holding the stock and the bond. Why does the household demand this premium? The bond pays out 1 in the future regardless of the realization of income. The stock pays out comparatively high dividend when income is high and a comparatively low dividend when income is low. This *does not* help the household smooth its consumption. In particular, the valuation of the dividend, $\beta \frac{u'(Y_{t+1})}{u'(Y_t)}$, is low when income is high (because high income means low $u'(\cdot)$ and vice-versa). This means that you *care more about the low dividend* than the high dividend when pricing the stock. As a result, you demand a comparatively high expected return (or yield) to be indifferent between holding the stock and the bond. In equilibrium, since both stock and bond are in finite supply, they must be priced such that the household is indifferent between the two.

The second row considers the case where all future states are equally likely. In this case, there is no equity premium. Note that there is no equity premium in spite of the fact that stock's payout is risky compared to the bond. As in Chapter 33, it is not risk *per se* which the household seeks to avoid, but rather the household dislikes assets whose payouts covary positively with income (equivalently, negatively with the marginal utility of consumption). In other words, it dislikes assets (and therefore demands a high expected return) which hurt it from smoothing its consumption. In this case, the stock's dividend is uncorrelated with the realization of income – the expected value of the dividend is 1 whether income is high or low. Since the payout on the bond is also uncorrelated with the realization of income, and since the bond and the stock offer the same expected payout, they trade for the same price and there is no difference in yields.

The third row considers an intermediate case; the dividend payout is positively correlated with income, but not as strongly as in the first row. We can see this by noting that the conditional expectations of the dividend payout in the high and low state are closer to the unconditional expectation of the dividend compared to the first row. As a result, the equity premium is positive, but not as large as in the first case. The final row of the upper part of Table 34.1 considers the case where the dividend payout covaries *negatively* with the realization of income. We can see this by noting that the expectation of the dividend conditional on income being low is higher than the unconditional expectation. In this case,

the stock is priced *higher* than the bond and the equity premium is *negative*. Put somewhat differently – if the stock has a high dividend when income is low, this *helps* the household smooth consumption, as it gets an income kick exactly when it most values it (i.e. when $u'(\cdot)$ is comparatively high). This means that there is greater demand for the stock than the bond, and since they offer the same expected return the yield on the stock must be lower than the bond.

The second part of Table 34.1 is similar to the first part, but supposes that the possible realizations of the dividend are double what they are in the first part of the table; i.e. $d_{t+1}^h = 3$ and $d_{t+1}^l = 1$. This means that the expected value of the future dividend is 2 instead of 1. This naturally results in the stock price being higher compared to the earlier case – the stock is worth more, because it pays out more in expectation. However, the yields on the stock are *identical* to the first part of the table, and hence the equity premia presented in the last column are also identical. As noted in Chapter 33, when comparing different types of assets comparing them by price is not always particularly useful. A stock which pays a higher dividend in expectation will naturally have a higher price. Whether it is a better investment opportunity in the sense of offering a higher expected return compared to a stock with a low dividend is not clear. To determine that, it is best to compare yields on different kinds of stocks.

34.2 Comparing Different Kinds of Stocks

It is straightforward (though somewhat laborious) to extend our analysis to a world with multiple different kinds of equities. Take the setup from the previous section with a risk-free bond, but allow for two different stocks, $SH_{1,t}$ and $SH_{2,t}$. These stocks trade at $Q_{1,t}$ and $Q_{2,t}$ in period t , and will pay dividends in period $t + 1$. The household's period t budget constraint is:

$$C_t + P_t^B B_t + Q_{1,t} SH_{1,t} + Q_{2,t} SH_{2,t} \leq Y_t \quad (34.25)$$

The specification of constraints in period $t + 1$ is somewhat more complicated, because there are additional sources of uncertainty. Suppose again that income could be high or low. In addition, suppose that the dividends on stocks 1 and 2 could also be high or low. This means that there are *eight* possible states of the world in period $t + 1$ ¹ – which we shall denote $(Y_{t+1}^h, d_{1,t+1}^h, d_{2,t+1}^h)$, $(Y_{t+1}^h, d_{1,t+1}^h, d_{2,t+1}^l)$, $(Y_{t+1}^h, d_{1,t+1}^l, d_{2,t+1}^h)$, $(Y_{t+1}^h, d_{1,t+1}^l, d_{2,t+1}^l)$, $(Y_{t+1}^l, d_{1,t+1}^h, d_{2,t+1}^h)$, $(Y_{t+1}^l, d_{1,t+1}^h, d_{2,t+1}^l)$, $(Y_{t+1}^l, d_{1,t+1}^l, d_{2,t+1}^h)$, $(Y_{t+1}^l, d_{1,t+1}^l, d_{2,t+1}^l)$. Denote the

¹The number of possible states of 8 is $2^3 = 8$. When there was only one kind of stock, as above, there were $2^2 = 4$ possible states.

probabilities of each of these eight states materializing as p_j for $j = 1, \dots, 8$, with $\sum_{j=1}^8 p_j = 1$. This means that there will be eight different budget constraints which must hold in period $t+1$. There will be different consumption values in different states. Use a triple superscript to denote the consumption value in a particular realization of the state. Let the first superscript denote whether income in $t+1$ is high or low, the second superscript whether the dividend on stock 1 is high or low, and the third superscript whether the dividend on the second stock is high or low. Going ahead and imposing the terminal conditions that the household will not die with positive stocks of debt, these $t+1$ budget constraints are given below:

$$C_{t+1}^{h,h,h} \leq Y_{t+1}^h + B_t + (d_{1,t+1}^h + Q_{1,t+1}^{h,h,h}) S_{1,t} + (d_{2,t+1}^h + Q_{2,t+1}^{h,h,h}) S_{2,t} \quad (34.26)$$

$$C_{t+1}^{h,h,l} \leq Y_{t+1}^h + B_t + (d_{1,t+1}^h + Q_{1,t+1}^{h,h,l}) S_{1,t} + (d_{2,t+1}^l + Q_{2,t+1}^{h,h,l}) S_{2,t} \quad (34.27)$$

$$C_{t+1}^{h,l,l} \leq Y_{t+1}^h + B_t + (d_{1,t+1}^l + Q_{1,t+1}^{h,l,l}) S_{1,t} + (d_{2,t+1}^l + Q_{2,t+1}^{h,l,l}) S_{2,t} \quad (34.28)$$

$$C_{t+1}^{h,l,h} \leq Y_{t+1}^h + B_t + (d_{1,t+1}^l + Q_{1,t+1}^{h,l,h}) S_{1,t} + (d_{2,t+1}^h + Q_{2,t+1}^{h,l,h}) S_{2,t} \quad (34.29)$$

$$C_{t+1}^{l,h,h} \leq Y_{t+1}^l + B_t + (d_{1,t+1}^h + Q_{1,t+1}^{l,h,h}) S_{1,t} + (d_{2,t+1}^h + Q_{2,t+1}^{l,h,h}) S_{2,t} \quad (34.30)$$

$$C_{t+1}^{l,h,l} \leq Y_{t+1}^l + B_t + (d_{1,t+1}^h + Q_{1,t+1}^{l,h,l}) S_{1,t} + (d_{2,t+1}^l + Q_{2,t+1}^{l,h,l}) S_{2,t} \quad (34.31)$$

$$C_{t+1}^{l,l,l} \leq Y_{t+1}^l + B_t + (d_{1,t+1}^l + Q_{1,t+1}^{l,l,l}) S_{1,t} + (d_{2,t+1}^l + Q_{2,t+1}^{l,l,l}) S_{2,t} \quad (34.32)$$

$$C_{t+1}^{l,l,h} \leq Y_{t+1}^l + B_t + (d_{1,t+1}^l + Q_{1,t+1}^{l,l,h}) S_{1,t} + (d_{2,t+1}^h + Q_{2,t+1}^{l,l,h}) S_{2,t} \quad (34.33)$$

Regardless of the realization of uncertainty in $t+1$, consumption (after imposing the terminal conditions) cannot exceed available resources. Available resources include the exogenous income flow, the payout from holdings of the riskless one period discount bond, and the uncertain payout from holdings of both stocks (which in principal include both a dividend and capital gain component).

The household wishes to maximize expected lifetime utility. Given the nature of uncertainty about $t+1$, this can be written:

$$U = u(C_t) + p_1 u(C_{t+1}^{h,h,h}) + p_2 u(C_{t+1}^{h,h,l}) + p_3 u(C_{t+1}^{h,l,l}) + p_4 u(C_{t+1}^{h,l,h}) \\ + p_5 u(C_{t+1}^{l,h,h}) + p_6 u(C_{t+1}^{l,h,l}) + p_7 u(C_{t+1}^{l,l,l}) + p_8 u(C_{t+1}^{l,l,h}) \quad (34.34)$$

The household's problem is to pick a consumption plan to maximize (34.34) subject to (34.25)-(34.33). It is easiest to characterize the problem by writing it as an unconstrained problem of choosing B_t , $SH_{1,t}$, and $SH_{2,t}$ in period t . The problem is:

$$\begin{aligned}
\max_{B_t, SH_{1,t}, SH_{2,t}} \quad & U = u \left[Y_t - P_t^B B_t - Q_{1,t} SH_{1,t} - Q_{2,t} SH_{2,t} \right] + \\
& p_1 \beta u \left[Y_{t+1}^h + B_t + (d_{1,t+1}^h + Q_{1,t+1}^{h,h,h}) SH_{1,t} + (d_{2,t+1}^h + Q_{2,t+1}^{h,h,h}) SH_{2,t} \right] + \\
& p_2 \beta u \left[Y_{t+1}^h + B_t + (d_{1,t+1}^h + Q_{1,t+1}^{h,h,l}) SH_{1,t} + (d_{2,t+1}^l + Q_{2,t+1}^{h,h,l}) SH_{2,t} \right] + \\
& p_3 \beta u \left[Y_{t+1}^h + B_t + (d_{1,t+1}^l + Q_{1,t+1}^{h,l,l}) SH_{1,t} + (d_{2,t+1}^l + Q_{2,t+1}^{h,l,l}) SH_{2,t} \right] + \\
& p_4 \beta u \left[Y_{t+1}^h + B_t + (d_{1,t+1}^l + Q_{1,t+1}^{h,l,h}) SH_{1,t} + (d_{2,t+1}^h + Q_{2,t+1}^{h,l,h}) SH_{2,t} \right] + \\
& p_5 \beta u \left[Y_{t+1}^l + B_t + (d_{1,t+1}^h + Q_{1,t+1}^{l,h,h}) SH_{1,t} + (d_{2,t+1}^h + Q_{2,t+1}^{l,h,h}) SH_{2,t} \right] + \\
& p_6 \beta u \left[Y_{t+1}^l + B_t + (d_{1,t+1}^h + Q_{1,t+1}^{l,h,l}) SH_{1,t} + (d_{2,t+1}^l + Q_{2,t+1}^{l,h,l}) SH_{2,t} \right] + \\
& p_7 \beta u \left[Y_{t+1}^l + B_t + (d_{1,t+1}^l + Q_{1,t+1}^{l,l,l}) SH_{1,t} + (d_{2,t+1}^l + Q_{2,t+1}^{l,l,l}) SH_{2,t} \right] + \\
& p_8 \beta u \left[Y_{t+1}^l + B_t + (d_{1,t+1}^l + Q_{1,t+1}^{l,l,h}) SH_{1,t} + (d_{2,t+1}^h + Q_{2,t+1}^{l,l,h}) SH_{2,t} \right] \quad (34.35)
\end{aligned}$$

The first order optimality conditions are:

$$\begin{aligned}
\frac{\partial U}{\partial B_t} = 0 \Leftrightarrow P_t^B u'(C_t) = \beta \left[p_1 u'(C_{t+1}^{h,h,h}) + p_2 u'(C_{t+1}^{h,h,l}) + p_3 u'(C_{t+1}^{h,l,l}) + p_4 u'(C_{t+1}^{h,l,h}) + \right. \\
\left. p_5 u'(C_{t+1}^{l,h,h}) + p_6 u'(C_{t+1}^{l,h,l}) + p_7 u'(C_{t+1}^{l,l,l}) + p_8 u'(C_{t+1}^{l,l,h}) \right] \quad (34.36)
\end{aligned}$$

$$\begin{aligned}
\frac{\partial U}{\partial SH_{1,t}} = 0 \Leftrightarrow Q_{1,t} u'(C_t) = \beta \left[p_1 (d_{1,t+1}^h + Q_{1,t+1}^{h,h,h}) u'(C_{t+1}^{h,h,h}) + p_2 (d_{1,t+1}^h + Q_{1,t+1}^{h,h,l}) u'(C_{t+1}^{h,h,l}) \right. \\
+ p_3 (d_{1,t+1}^l + Q_{1,t+1}^{h,l,l}) u'(C_{t+1}^{h,l,l}) + p_4 (d_{1,t+1}^l + Q_{1,t+1}^{h,l,h}) u'(C_{t+1}^{h,l,h}) + p_5 (d_{1,t+1}^h + Q_{1,t+1}^{l,h,h}) u'(C_{t+1}^{l,h,h}) \\
+ p_6 (d_{1,t+1}^h + Q_{1,t+1}^{l,h,l}) u'(C_{t+1}^{l,h,l}) + p_7 (d_{1,t+1}^l + Q_{1,t+1}^{l,l,l}) u'(C_{t+1}^{l,l,l}) + \\
\left. p_8 (d_{1,t+1}^l + Q_{1,t+1}^{l,l,h}) u'(C_{t+1}^{l,l,h}) \right] \quad (34.37)
\end{aligned}$$

$$\begin{aligned}
\frac{\partial U}{\partial SH_{2,t}} = 0 \Leftrightarrow Q_{2,t}u'(C_t) = \beta & \left[p_1(d_{2,t+1}^h + Q_{2,t+1}^{h,h,h})u'(C_{t+1}^{h,h,h}) + p_2(d_{2,t+1}^l + Q_{2,t+1}^{h,h,l})u'(C_{t+1}^{h,h,l}) \right. \\
& + p_3(d_{2,t+1}^l + Q_{2,t+1}^{h,l,l})u'(C_{t+1}^{h,l,l}) + p_4(d_{2,t+1}^h + Q_{2,t+1}^{h,l,h})u'(C_{t+1}^{h,l,h}) + p_5(d_{2,t+1}^h + Q_{2,t+1}^{l,h,h})u'(C_{t+1}^{l,h,h}) \\
& + p_6(d_{2,t+1}^l + Q_{2,t+1}^{l,h,l})u'(C_{t+1}^{l,h,l}) + p_7(d_{2,t+1}^l + Q_{2,t+1}^{l,l,l})u'(C_{t+1}^{l,l,l}) + \\
& \left. p_8(d_{2,t+1}^h + Q_{2,t+1}^{l,l,h})u'(C_{t+1}^{l,l,h}) \right] \quad (34.38)
\end{aligned}$$

(34.36)-(34.38) all look somewhat nasty but all have fairly intuitive interpretations. In particular, the terms on the left hand sides are simply the marginal utility costs of purchasing an additional unit of each of the three different kinds of assets, while the right hand sides are the expected marginal utility benefits of doing so. The expressions end up looking nasty because there are eight possible states of nature in $t + 1$. Written more compactly in terms of expectations operators, however, these FOC can be written:

$$P_t^B u'(C_t) = \beta \mathbb{E}[u'(C_{t+1})] \quad (34.39)$$

$$Q_{1,t}u'(C_t) = \beta \mathbb{E}[(d_{1,t+1} + Q_{1,t+1})u'(C_{t+1})] \quad (34.40)$$

$$Q_{2,t}u'(C_t) = \beta \mathbb{E}[(d_{2,t+1} + Q_{2,t+1})u'(C_{t+1})] \quad (34.41)$$

We again are working in the confines of an endowment economy in which all assets are in zero net supply. This means that $C_t = Y_t$ and $C_{t+1} = Y_{t+1}$ regardless of the realization of $t + 1$ uncertainty. Because $u'(Y_t)$ is known in period t , these can be written in the usual setup wherein the price of the asset is the expected value off the product of the stochastic discount factor with the $t + 1$ payout from holding the asset:

$$P_t^B = \mathbb{E} \left[\frac{\beta u'(Y_{t+1})}{u'(Y_t)} \right] \quad (34.42)$$

$$Q_{1,t} = \mathbb{E} \left[\frac{\beta u'(Y_{t+1})}{u'(Y_t)} (d_{1,t+1} + Q_{1,t+1}) \right] \quad (34.43)$$

$$Q_{2,t} = \mathbb{E} \left[\frac{\beta u'(Y_{t+1})}{u'(Y_t)} (d_{2,t+1} + Q_{2,t+1}) \right] \quad (34.44)$$

We can then write the yields on each asset as the ratio of the expected payout divided by the price, or:

$$1 + r_t = \frac{1}{P_t^B} = \frac{1}{\mathbb{E}\left[\frac{\beta u'(Y_{t+1})}{u'(Y_t)}\right]} \quad (34.45)$$

$$1 + r_{s,1,t} = \frac{\mathbb{E}[d_{1,t+1} + Q_{1,t+1}]}{Q_{1,t}} = \frac{\mathbb{E}[d_{1,t+1} + Q_{1,t+1}]}{\mathbb{E}\left[\frac{\beta u'(Y_{t+1})}{u'(Y_t)}(d_{1,t+1} + Q_{1,t+1})\right]} \quad (34.46)$$

$$1 + r_{s,2,t} = \frac{\mathbb{E}[d_{2,t+1} + Q_{2,t+1}]}{Q_{2,t}} = \frac{\mathbb{E}[d_{2,t+1} + Q_{2,t+1}]}{\mathbb{E}\left[\frac{\beta u'(Y_{t+1})}{u'(Y_t)}(d_{2,t+1} + Q_{2,t+1})\right]} \quad (34.47)$$

We construct a numerical example to illustrate how the different kinds of stocks might be priced differently and offer different yields. Assume that current income is $Y_t = 1$ and the discount factor is $\beta = 0.95$. Let the utility function be the natural log. We assume that the two values income can take on in the future are $Y_{t+1}^h = 1.1$ and $Y_{t+1}^l = 0.9$. Assume that the first stock offers a relatively stable dividend, with $d_{1,t+1}^h = 1.05$ and $d_{1,t+1}^l = 0.95$. Assume that the dividend of the second stock is much more volatile. In particular, let $d_{2,t+1}^h = 1.5$ and $d_{2,t+1}^l = 0.5$. Let us specify the probabilities of different states as follows. Assume that $p_1 = 0.4$ and $p_4 = 0.1$, with $p_2 = p_3 = 0$. This means that there is a 50 percent chance of income being high; conditional on income being high, both stocks pay a high dividend with 80 percent probability (i.e. $0.4/0.5 = 0.8$) and pay a low dividend with 20 percent probability (i.e. $0.1/0.5 = 0.2$). Similarly, let us assume that $p_7 = 0.4$ and $p_5 = 0.1$, with $p_6 = p_8 = 0$. This means that conditional on income being low, both stocks offer a low dividend (state 5) with 80 percent probability and a high dividend with probability 20 percent. For simplicity, we assume that it is never the case that one stock pays a high dividend and the other pays a low dividend. Note that the example has been setup up where all three assets offer an expected payout of 1 in $t + 1$.

If we work through the numbers, we get the following prices: $P_t = 0.959$, $Q_{1,t} = 0.956$, and $Q_{2,t} = 0.931$. Even though all three assets offer the same expected payout in $t + 1$, the bond is most valuable, followed by the first stock and then the second. This is because the bond's payout does not covary with the future marginal utility of consumption, whereas the payouts of both stocks are high when future income is high, which means that their payouts covary negatively with the marginal utility of consumption. In terms of yields, the bond yields 0.042, the first stock yields 0.045, and the second stock 0.074. The household demands a premium in the form of a higher expected return to hold either stock relative to the bond, and in turn demands a higher premium to be willing to hold the second stock compared to the first stock. This is because the dividend payout from the second stock covaries much more negatively with the marginal utility of future consumption than does the first stock.

Once again, note that the numerical example could be altered in such a way as to change

the prices of the stocks but not the relative yields. For example, suppose that the second stock pays a dividend of $d_{2,t+1}^h = 3$ or $d_{2,t+1}^l = 1$. This means that its expected payout is 2, which is double the expected payout on the bond or the first stock. It therefore trades at a higher price. Keeping everything the same as in the previous example, we would get $P_{2,t} = 1.86$, or twice as high as when the expected dividend was 1. But in terms of yields, the expected yield/return on stock 2 is still 0.074. This example yet again underscores the fact that it is most appropriate to compare different assets in terms of yields, not prices.

This analysis reveals a potentially important insight when thinking about the cross-section of stock returns. In particular, stocks whose returns are positively correlated with the overall economy (i.e. they are procyclical) ought to command a higher expected return (yield) compared to stocks whose returns are less correlated, or even negatively correlated, with the economy. A household's objective is to maximize its expected lifetime utility, which entails investing in assets that help it smooth its consumption. An asset that offers low payouts when consumption would otherwise already be low does not help smooth consumption, and hence optimizing households ought to demand a premium in the form of a higher expected return to be willing to hold such a stock. On average, stock returns are procyclical, and this is why the average equity premium over risk-free government debt is positive. But across different types of stocks, some are more procyclical than others. Other things being equal, we would expect the most procyclical stocks to trade at the highest expected returns to compensate investors for risk.

34.3 Moving Beyond Two Periods

Return to assuming that there is only one kind of equity available for purchase, but instead suppose that the household lives for three periods – t , $t + 1$, and $t + 2$. In period t , the household can once again purchase a risk free, one period bond or a risky equity. Its budget constraint is:

$$C_t + P_t^B B_t + Q_t S H_t \leq Y_t \quad (34.48)$$

In period $t + 1$, there are four possible states of nature – income could be high or low and the dividend from the stock could be high or low. The household can purchase more one period bonds which pay out in period $t + 2$, or it could purchase more stock. Resources come from the exogenous income flow, payouts on the one period riskless bond brought from t to $t + 1$, and dividend payouts on shares of stock brought from t to $t + 1$. The flow budget constraint must hold in each state of nature. For period $t + 1$, this requires:

$$C_{t+1}^{h,h} + P_{t+1}^{B,h,h} B_{t+1}^{h,h} + Q_{t+1}^{h,h} (SH_{t+1}^{h,h} - SH_t) \leq Y_{t+1}^h + B_t + d_{t+1}^h SH_t \quad (34.49)$$

$$C_{t+1}^{h,l} + P_{t+1}^{B,h,l} B_{t+1}^{h,l} + Q_{t+1}^{h,l} (SH_{t+1}^{h,l} - SH_t) \leq Y_{t+1}^h + B_t + d_{t+1}^l SH_t \quad (34.50)$$

$$C_{t+1}^{l,l} + P_{t+1}^{B,l,l} B_{t+1}^{l,l} + Q_{t+1}^{l,l} (SH_{t+1}^{l,l} - SH_t) \leq Y_{t+1}^l + B_t + d_{t+1}^l SH_t \quad (34.51)$$

$$C_{t+1}^{l,h} + P_{t+1}^{B,l,h} B_{t+1}^{l,h} + Q_{t+1}^{l,h} (SH_{t+1}^{l,h} - SH_t) \leq Y_{t+1}^l + B_t + d_{t+1}^h SH_t \quad (34.52)$$

In (34.45)-(34.52), the first superscript refers to the output state, while the second refers to the state of nature for the dividend. There are again four states of nature in $t+2$ – income could be high or low, and the dividend could be high or low. But because consumption in these states depends on the realization of uncertainty in $t+1$, there are in principle *sixteen* possible states of nature in $t+2$ – four states for each of the four states possible in $t+1$ (i.e. $4^2 = 16$).

We will denote the realization of the state in $t+2$ with a four part superscript. The first entry denotes the output state in $t+2$, the second the dividend state in $t+2$, the third the output state in $t+1$, and the fourth the dividend state in $t+1$. For example, (h, l, h, l) means high output in $t+2$, low dividend in $t+2$, high output in $t+1$, and low dividend in $t+1$. The $t+2$ constraints can be written:

$$C_{t+2}^{h,h,h,h} + P_{t+2}^{B,h,h,h,h} B_{t+2}^{h,h,h,h} + Q_{t+2}^{h,h,h,h} (SH_{t+2}^{h,h,h,h} - SH_{t+1}^{h,h}) \leq Y_{t+2}^h + B_{t+1}^{h,h} + d_{t+2}^h SH_{t+1}^{h,h} \quad (34.53)$$

$$C_{t+2}^{h,l,h,h} + P_{t+2}^{B,h,l,h,h} B_{t+2}^{h,l,h,h} + Q_{t+2}^{h,l,h,h} (SH_{t+2}^{h,l,h,h} - SH_{t+1}^{h,h}) \leq Y_{t+2}^h + B_{t+1}^{h,h} + d_{t+2}^l SH_{t+1}^{h,h} \quad (34.54)$$

$$C_{t+2}^{l,l,h,h} + P_{t+2}^{B,l,l,h,h} B_{t+2}^{l,l,h,h} + Q_{t+2}^{l,l,h,h} (SH_{t+2}^{l,l,h,h} - SH_{t+1}^{h,h}) \leq Y_{t+2}^l + B_{t+1}^{h,h} + d_{t+2}^l SH_{t+1}^{h,h} \quad (34.55)$$

$$C_{t+2}^{l,h,h,h} + P_{t+2}^{B,l,h,h,h} B_{t+2}^{l,h,h,h} + Q_{t+2}^{l,h,h,h} (SH_{t+2}^{l,h,h,h} - SH_{t+1}^{h,h}) \leq Y_{t+2}^l + B_{t+1}^{h,h} + d_{t+2}^h SH_{t+1}^{h,h} \quad (34.56)$$

$$C_{t+2}^{h,h,h,l} + P_{t+2}^{B,h,h,h,l} B_{t+2}^{h,h,h,l} + Q_{t+2}^{h,h,h,l} (SH_{t+2}^{h,h,h,l} - SH_{t+1}^{h,l}) \leq Y_{t+2}^h + B_{t+1}^{h,l} + d_{t+2}^h SH_{t+1}^{h,l} \quad (34.57)$$

$$C_{t+2}^{h,l,h,l} + P_{t+2}^{B,h,l,h,l} B_{t+2}^{h,l,h,l} + Q_{t+2}^{h,l,h,l} (SH_{t+2}^{h,l,h,l} - SH_{t+1}^{h,l}) \leq Y_{t+2}^h + B_{t+1}^{h,l} + d_{t+2}^l SH_{t+1}^{h,l} \quad (34.58)$$

$$C_{t+2}^{l,l,h,l} + P_{t+2}^{B,l,l,h,l} B_{t+2}^{l,l,h,l} + Q_{t+2}^{l,l,h,l} (SH_{t+2}^{l,l,h,l} - SH_{t+1}^{h,l}) \leq Y_{t+2}^l + B_{t+1}^{h,l} + d_{t+2}^l SH_{t+1}^{h,l} \quad (34.59)$$

$$C_{t+2}^{l,h,h,l} + P_{t+2}^{B,l,h,h,l} B_{t+2}^{l,h,h,l} + Q_{t+2}^{l,h,h,l} (SH_{t+2}^{l,h,h,l} - SH_{t+1}^{h,l}) \leq Y_{t+2}^l + B_{t+1}^{h,l} + d_{t+2}^h SH_{t+1}^{h,l} \quad (34.60)$$

$$C_{t+2}^{h,h,l,l} + P_{t+2}^{B,h,h,l,l} B_{t+2}^{h,h,l,l} + Q_{t+2}^{h,h,l,l} (SH_{t+2}^{h,h,l,l} - SH_{t+1}^{l,l}) \leq Y_{t+2}^h + B_{t+1}^{l,l} + d_{t+2}^h SH_{t+1}^{l,l} \quad (34.61)$$

$$C_{t+2}^{h,l,l,l} + P_{t+2}^{B,h,l,l,l} B_{t+2}^{h,l,l,l} + Q_{t+2}^{h,l,l,l} (SH_{t+2}^{h,l,l,l} - SH_{t+1}^{l,l}) \leq Y_{t+2}^h + B_{t+1}^{l,l} + d_{t+2}^l SH_{t+1}^{l,l} \quad (34.62)$$

$$C_{t+2}^{l,l,l,l} + P_{t+2}^{B,l,l,l,l} B_{t+2}^{l,l,l,l} + Q_{t+2}^{l,l,l,l} (SH_{t+2}^{l,l,l,l} - SH_{t+1}^{l,l}) \leq Y_{t+2}^l + B_{t+1}^{l,l} + d_{t+2}^l SH_{t+1}^{l,l} \quad (34.63)$$

$$C_{t+2}^{l,h,l,l} + P_{t+2}^{B,l,h,l,l} B_{t+2}^{l,h,l,l} + Q_{t+2}^{l,h,l,l} (SH_{t+2}^{l,h,l,l} - SH_{t+1}^{l,l}) \leq Y_{t+2}^l + B_{t+1}^{l,l} + d_{t+2}^h SH_{t+1}^{l,l} \quad (34.64)$$

$$C_{t+2}^{h,h,l,h} + P_{t+2}^{B,h,h,l,h} B_{t+2}^{h,h,l,h} + Q_{t+2}^{h,h,l,h} (SH_{t+2}^{h,h,l,h} - SH_{t+1}^{l,h}) \leq Y_{t+2}^h + B_{t+1}^{l,h} + d_{t+2}^h SH_{t+1}^{l,h} \quad (34.65)$$

$$C_{t+2}^{h,l,l,h} + P_{t+2}^{B,h,l,l,h} B_{t+2}^{h,l,l,h} + Q_{t+2}^{h,l,l,h} (SH_{t+2}^{h,l,l,h} - SH_{t+1}^{l,h}) \leq Y_{t+2}^h + B_{t+1}^{l,h} + d_{t+2}^l SH_{t+1}^{l,h} \quad (34.66)$$

$$C_{t+2}^{l,l,l,h} + P_{t+2}^{B,l,l,l,h} B_{t+2}^{l,l,l,h} + Q_{t+2}^{l,l,l,h} (SH_{t+2}^{l,l,l,h} - SH_{t+1}^{l,h}) \leq Y_{t+2}^l + B_{t+1}^{l,h} + d_{t+2}^l SH_{t+1}^{l,h} \quad (34.67)$$

$$C_{t+2}^{l,h,l,h} + P_{t+2}^{B,l,h,l,h} B_{t+2}^{l,h,l,h} + Q_{t+2}^{l,h,l,h} (SH_{t+2}^{l,h,l,h} - SH_{t+1}^{l,h}) \leq Y_{t+2}^l + B_{t+1}^{l,h} + d_{t+2}^h SH_{t+1}^{l,h} \quad (34.68)$$

Let p_1 be the probability that both income and the dividend are high in $t + 1$, p_2 be the probability that income is high and the dividend is low in $t + 1$; p_3 by the probability that both income and the dividend are low in $t + 1$; and $p_4 = 1 - p_1 - p_2 - p_3$ be the probability that income is low and the dividend is high in $t + 1$. It must be the case that the sum of these probabilities is one because some state of nature must occur in $t + 1$. Let q_1, \dots, q_{16} , with $\sum_{j=1}^{16} q_j = 1$, be the probabilities of each of the sixteen states of nature described in (34.53)-(34.68) occurring. These probabilities must sum to one because some state of nature must materialize in $t + 2$. Note that a special case of this probability specification would be one in which the four states occur in $t + 2$ independently of what happened in $t + 1$. If this were the case, we would have $q_1 = p_1^2$ - i.e. the probability of the (h, h) state in $t + 1$, p_1 , times the probability of the (h, h) state in $t + 2$, also p_1 . In writing it instead the way that we do, we allow for the realizations across time to potentially not be independent.

The household's objective is to maximize the present discounted value of lifetime utility. This can be written:

$$\begin{aligned} U = & u(C_t) + \beta [p_1 u(C_{t+1}^{h,h}) + p_2 u(C_{t+1}^{h,l}) + p_3 u(C_{t+1}^{l,l}) + p_4 u(C_{t+1}^{l,h})] \\ & + \beta^2 [q_1 u(C_{t+2}^{h,h,h,h}) + q_2 u(C_{t+2}^{h,l,h,h}) + q_3 u(C_{t+2}^{l,l,h,h}) + q_4 u(C_{t+2}^{l,h,h,h}) + q_5 u(C_{t+2}^{h,h,h,l}) + q_6 u(C_{t+2}^{h,l,h,l}) + q_7 u(C_{t+2}^{l,l,h,l}) \\ & + q_8 u(C_{t+2}^{l,h,h,l}) + q_9 u(C_{t+2}^{h,h,l,l}) + q_{10} u(C_{t+2}^{h,l,l,l}) + q_{11} u(C_{t+2}^{l,l,l,l}) + q_{12} u(C_{t+2}^{l,h,l,l}) + \\ & q_{13} u(C_{t+2}^{h,h,l,h}) + q_{14} u(C_{t+2}^{h,l,l,h}) + q_{15} u(C_{t+2}^{l,l,l,h}) + q_{16} u(C_{t+2}^{l,h,l,h})] \quad (34.69) \end{aligned}$$

We can again invoke terminal conditions to simplify the analysis. In particular, the household will not choose to die with positive stocks of bonds or stock in $t + 2$. This means that $B_{t+2} = 0$ and $SH_{t+2} = 0$ regardless of the realization of uncertainty. It is easiest to think about the problem by substituting in all the constraints into the objective function so as to eliminate the different consumption terms. Then the problem amounts to one of picking B_t , SH_t , B_{t+1} in all four states, and SH_{t+1} in all four states of nature in $t + 1$.

The first order optimality conditions with respect to each of these choices are given below:

$$B_t : P_t^B u'(C_t) = \beta [p_1 u'(C_{t+1}^{h,h}) + p_2 u'(C_{t+1}^{h,l}) + p_3 u'(C_{t+1}^{l,l}) + p_4 u'(C_{t+1}^{l,h})] \quad (34.70)$$

$$SH_t : Q_t u'(C_t) = \beta [p_1 u'(C_{t+1}^{h,h})(d_{t+1}^h + Q_{t+1}^{h,h}) + p_2 u'(C_{t+1}^{h,l})(d_{t+1}^l + Q_{t+1}^{h,l}) + p_3 u'(C_{t+1}^{l,l})(d_{t+1}^l + Q_{t+1}^{l,l}) + p_4 u'(C_{t+1}^{l,h})(d_{t+1}^h + Q_{t+1}^{l,h})] \quad (34.71)$$

$$B_{t+1}^{h,h} : p_1 P_{t+1}^{h,h} u'(C_{t+1}^{h,h}) = \beta [q_1 u'(C_{t+2}^{h,h,h,h}) + q_2 u'(C_{t+2}^{h,l,h,h}) + q_3 u'(C_{t+2}^{l,l,h,h}) + q_4 u'(C_{t+2}^{l,h,h,h})] \quad (34.72)$$

$$B_{t+1}^{h,l} : p_2 P_{t+1}^{h,l} u'(C_{t+1}^{h,l}) = \beta [q_5 u'(C_{t+2}^{h,h,h,l}) + q_6 u'(C_{t+2}^{h,l,h,l}) + q_7 u'(C_{t+2}^{l,l,h,l}) + q_8 u'(C_{t+2}^{l,h,h,l})] \quad (34.73)$$

$$B_{t+1}^{l,l} : p_3 P_{t+1}^{l,l} u'(C_{t+1}^{l,l}) = \beta [q_9 u'(C_{t+2}^{h,h,l,l}) + q_{10} u'(C_{t+2}^{h,l,l,l}) + q_{11} u'(C_{t+2}^{l,l,l,l}) + q_{12} u'(C_{t+2}^{l,h,l,l})] \quad (34.74)$$

$$B_{t+1}^{l,h} : p_4 P_{t+1}^{l,h} u'(C_{t+1}^{l,h}) = \beta [q_{13} u'(C_{t+2}^{h,h,l,h}) + q_{14} u'(C_{t+2}^{h,l,l,h}) + q_{15} u'(C_{t+2}^{l,l,l,h}) + q_{16} u'(C_{t+2}^{l,h,l,h})] \quad (34.75)$$

$$SH_{t+1}^{h,h} : p_1 Q_{t+1}^{h,h} u'(C_{t+1}^{h,h}) = \beta [q_1 u'(C_{t+2}^{h,h,h,h})(d_{t+2}^h + Q_{t+2}^{h,h,h,h}) + q_2 u'(C_{t+2}^{h,l,h,h})(d_{t+2}^l + Q_{t+2}^{h,l,h,h}) + q_3 u'(C_{t+2}^{l,l,h,h})(d_{t+2}^l + Q_{t+2}^{l,l,h,h}) + q_4 u'(C_{t+2}^{l,h,h,h})(d_{t+2}^h + Q_{t+2}^{l,h,h,h})] \quad (34.76)$$

$$SH_{t+1}^{h,l} : p_2 Q_{t+1}^{h,l} u'(C_{t+1}^{h,l}) = \beta [q_5 u'(C_{t+2}^{h,h,h,l})(d_{t+2}^h + Q_{t+2}^{h,h,h,l}) + q_6 u'(C_{t+2}^{h,l,h,l})(d_{t+2}^l + Q_{t+2}^{h,l,h,l}) + q_7 u'(C_{t+2}^{l,l,h,l})(d_{t+2}^l + Q_{t+2}^{l,l,h,l}) + q_8 u'(C_{t+2}^{l,h,h,l})(d_{t+2}^h + Q_{t+2}^{l,h,h,l})] \quad (34.77)$$

$$SH_{t+1}^{l,l} : p_3 Q_{t+1}^{l,l} u'(C_{t+1}^{l,l}) = \beta [q_9 u'(C_{t+2}^{h,h,l,l})(d_{t+2}^h + Q_{t+2}^{h,h,l,l}) + q_{10} u'(C_{t+2}^{h,l,l,l})(d_{t+2}^l + Q_{t+2}^{h,l,l,l}) + q_{11} u'(C_{t+2}^{l,l,l,l})(d_{t+2}^l + Q_{t+2}^{l,l,l,l}) + q_{12} u'(C_{t+2}^{l,h,l,l})(d_{t+2}^h + Q_{t+2}^{l,h,l,l})] \quad (34.78)$$

$$SH_{t+1}^{l,h} : p_4 Q_{t+1}^{l,h} u'(C_{t+1}^{l,h}) = \beta [q_{13} u'(C_{t+2}^{h,h,l,h})(d_{t+2}^h + Q_{t+2}^{h,h,l,h}) + q_{14} u'(C_{t+2}^{h,l,l,h})(d_{t+2}^l + Q_{t+2}^{h,l,l,h}) + q_{15} u'(C_{t+2}^{l,l,l,h})(d_{t+2}^l + Q_{t+2}^{l,l,l,h}) + q_{16} u'(C_{t+2}^{l,h,l,h})(d_{t+2}^h + Q_{t+2}^{l,h,l,h})] \quad (34.79)$$

(34.70)-(34.79) once again look nasty, but have much cleaner interpretations when written using expectations operators. In particular, (34.70)-(34.71) can be written:

$$P_t^B u'(C_t) = \beta \mathbb{E}[u'(C_{t+1})] \quad (34.80)$$

$$Q_t u'(C_t) = \beta \mathbb{E}[u'(C_{t+1})(d_{t+1} + Q_{t+1})] \quad (34.81)$$

(34.80)-(34.81) are entirely standard and indeed look exactly the same as in the two period model (see, e.g., (34.14)-(34.15)). Because β is constant and C_t is known, these can both be written in the by-now-familiar stochastic discount factor form:

$$P_t^B = \mathbb{E} \left[\frac{\beta u'(C_{t+1})}{u'(C_t)} \right] \quad (34.82)$$

$$Q_t = \mathbb{E} \left[\frac{\beta u'(C_{t+1})}{u'(C_t)} (d_{t+1} + Q_{t+1}) \right] \quad (34.83)$$

Next, let us turn to the other first order conditions, which are new since we have added a third period. Note that if one *sums* (34.72)-(34.75), one gets that the expected value of the product of the bond price in $t + 1$ with the marginal utility of consumption in period $t + 1$ (i.e. $p_1 P_{t+1}^{B,h,h} u'(C_{t+1}^{h,h}) + p_2 P_{t+1}^{B,h,l} u'(C_{t+1}^{h,l}) + p_3 P_{t+1}^{B,l,l} u'(C_{t+1}^{l,l}) + p_4 P_{t+1}^{B,l,h} u'(C_{t+1}^{l,h})$) equals β times the expected value of the marginal utility of consumption in $t + 2$ (i.e. $q_1 u'(C_{t+2}^{h,h,h,h}) + \dots + q_{16} u'(C_{t+2}^{l,h,lh})$). We can do the same thing with (34.76)-(34.79). We get:

$$\mathbb{E} [P_{t+1}^B u'(C_{t+1})] = \beta \mathbb{E} [u'(C_{t+2})] \quad (34.84)$$

$$\mathbb{E} [Q_{t+1} u'(C_{t+1})] = \beta \mathbb{E} [u'(C_{t+2})(d_{t+2} + Q_{t+2})] \quad (34.85)$$

(34.84)-(34.85) are the same as (34.82)-(34.83), except led one period into the future and with an expectation operator on both sides of the equality. But we can actually say *more* than just that the same pricing condition holds in expectation in $t + 1$. For example, focus on (34.72). Divide both sides of the equality by p_1 . One gets:

$$P_{t+1}^{B,h,h} u'(C_{t+1}^{h,h}) = \beta \left[\frac{q_1}{p_1} u'(C_{t+2}^{h,h,h,h}) + \frac{q_2}{p_1} u'(C_{t+2}^{h,l,h,h}) + \frac{q_3}{p_1} u'(C_{t+2}^{l,l,h,h}) + \frac{q_4}{p_1} u'(C_{t+2}^{l,h,h,h}) \right] \quad (34.86)$$

The left hand side of (34.86) is the *realized* product of the price of the bond and the marginal utility of consumption in the (h, h) state in $t + 1$. The right hand side is the expected value of the $t + 2$ marginal utility of consumption *conditional* on the (h, h) state occurring in $t + 1$.² (34.73)-(34.75) can be written in a similar way with a similar interpretation. Define

²This is a straightforward application of rules of conditional probability, which states that for two random variables X and Y , the probability of Y given X , $Pr(Y | X)$, equals the ratio of the probability of *both* X and Y occurring, $Pr(Y \cap X)$, divided by the probability of X , so $Pr(Y | X) = \frac{Pr(Y \cap X)}{Pr(X)}$. In the way we have laid out the probabilities, p_1 is the probability of both income and the dividend being high in $t + 1$, while q_1 is the probability of both income and the dividend being high in *both* $t + 1$ and $t + 2$. Hence, $\frac{q_1}{p_1}$ is the probability of income and the dividend both being high in $t + 2$, conditional on both income and the dividend being high in $t + 1$. Similarly, $\frac{q_2}{p_1}$ is the probability of income being high and the dividend being low in $t + 2$, conditional on income and the dividend both being high in $t + 1$. And so on.

$\mathbb{E}_{t+1}[\cdot]$ as the expectation *conditional* on the realization of the state in $t + 1$. In other words, (34.84) must not only hold in expectation based on what is known in period t , it must hold in *in all states of the world* in $t + 1$. Hence:

$$P_{t+1}^B = \mathbb{E}_{t+1} \left[\frac{\beta u'(C_{t+2})}{u'(C_{t+1})} \right] \quad (34.87)$$

By similar logic, we can see from (34.76)-(34.79) that (34.85) must not only hold in expectation from the perspective of period t , but also in each realization of uncertainty in $t + 1$:

$$Q_{t+1} = \mathbb{E}_{t+1} \left[\frac{\beta u'(C_{t+2})}{u'(C_{t+1})} (d_{t+2} + Q_{t+2}) \right] \quad (34.88)$$

(34.88) is particularly useful, because it can be used in conjunction with (34.83) to eliminate Q_{t+1} . In particular, we can write:

$$Q_t = \mathbb{E} \left[\frac{\beta u'(C_{t+1})}{u'(C_t)} \left(d_{t+1} + \mathbb{E}_{t+1} \left[\frac{\beta u'(C_{t+2})}{u'(C_{t+1})} (d_{t+2} + Q_{t+2}) \right] \right) \right] \quad (34.89)$$

Now, if we distribute inside the outer expectations operate, we get:

$$Q_t = \mathbb{E} \left[\frac{\beta u'(C_{t+1})}{u'(C_t)} d_{t+1} + \beta^2 \frac{u'(C_{t+1})}{u'(C_t)} \mathbb{E}_{t+1} \frac{u'(C_{t+2})}{u'(C_{t+1})} d_{t+2} + \beta^2 \frac{u'(C_{t+1})}{u'(C_t)} \mathbb{E}_{t+1} \frac{u'(C_{t+2})}{u'(C_{t+1})} Q_{t+2} \right] \quad (34.90)$$

(34.90) can be simplified along two dimensions. First, we can impose a terminal condition on the period $t + 2$ price of the stock, $Q_{t+2} = 0$. This is because the stock is a claim to future dividends, and there is no future from the perspective of $t + 2$, so in equilibrium the stock should be worthless. Second, an application of the [Law of Iterated Expectations](#) says that the unconditional expectation of a conditional expectation is the unconditional expectation. Taken together, we can write:

$$Q_t = \mathbb{E} \left[\frac{\beta u'(C_{t+1})}{u'(C_t)} d_{t+1} + \frac{\beta^2 u'(C_{t+2})}{u'(C_t)} d_{t+2} \right] \quad (34.91)$$

In other words, the price of the stock ought to equal the present discounted value of future dividends, where discounting is by the stochastic discount factor. For a multi-period framework, the stochastic discount factor can be defined as:

$$m_{t,t+j} = \frac{\beta^j u'(C_{t+j})}{u'(C_t)} \quad (34.92)$$

The stochastic discount factor measures how payouts in $t + j$ ought to be valued from the perspective of period t . Hence, we can more compactly write (34.91) as:

$$Q_t = \mathbb{E} \left[\sum_{j=1}^2 m_{t,t+j} d_{t+j} \right] \quad (34.93)$$

Now, let us return to (34.91). Note that we can write:

$$Q_t = \mathbb{E} \left[\frac{\beta u'(C_{t+1})}{u'(C_t)} d_{t+1} \right] + \mathbb{E} \left[\frac{\beta u'(C_{t+1})}{u'(C_t)} \mathbb{E}_{t+1} \left[\frac{\beta u'(C_{t+2})}{u'(C_{t+1})} d_{t+2} \right] \right] \quad (34.94)$$

Now, if there were no uncertainty over the future (or more generally if there were no correlation/covariance between future dividends and the stochastic discount factor), we could write (34.94) as:

$$Q_t = P_t d_{t+1} + P_t P_{t+1} d_{t+2} \quad (34.95)$$

But since the bond prices are just inverse of gross yields, (34.95) could be written:

$$Q_t = \frac{d_{t+1}}{1 + r_t} + \frac{d_{t+2}}{(1 + r_t)(1 + r_{t+1})} \quad (34.96)$$

From (34.96), if there were no uncertainty then the stock price would simply be the present discounted value of dividend payouts, where discounting is by the yield on the one period risk-free bond. But in general, (34.96) will not hold because there is uncertainty, and future dividends will be discounted at a potentially *higher* rate than the gross yield on the risk-free bond.

In an endowment economy equilibrium, we must have consumption equal income at all dates and all possible realizations of uncertainty. This means we can replace consumption values with exogenous values of income and use the above-derived expressions to price each asset. As before, we can define the yields/expected returns on each type of asset as the discount rate which rationalizes the current price of the asset in terms of the expected value of future cash flows. For the bond, the yield is simply:

$$1 + r_t = \frac{1}{P_t^B} = \frac{1}{\mathbb{E} \left[\frac{\beta u'(Y_{t+1})}{u'(Y_t)} \right]} \quad (34.97)$$

$$1 + r_{s,t} = \frac{\mathbb{E}[d_{t+1} + Q_{t+1}]}{Q_t} \quad (34.98)$$

(34.98) is the expected return on holding the stock. Note that there are two components to this expected return. It can be written:

$$1 + r_{s,t} = \frac{\mathbb{E}[d_{t+1}]}{Q_t} + \frac{\mathbb{E}[Q_{t+1}]}{Q_t} \quad (34.99)$$

In (34.99), the first component is the *dividend yield* (expected dividend divided by current share prices) and the second component is the *capital gain* (expected share price divided by current share price). Note that (34.98) can be written:

$$1 + r_{s,t} = \frac{\mathbb{E}[d_{t+1} + Q_{t+1}]}{\mathbb{E}\left[\frac{\beta u'(Y_{t+1})}{u'(Y_t)}(d_{t+1} + Q_{t+1})\right]} \quad (34.100)$$

The equity premium is simply the ratio of the two yields:

$$\frac{1 + r_{s,t}}{1 + r_t} = \frac{\mathbb{E}[d_{t+1} + Q_{t+1}] \mathbb{E}\left[\frac{\beta u'(Y_{t+1})}{u'(Y_t)}\right]}{\mathbb{E}\left[\frac{\beta u'(Y_{t+1})}{u'(Y_t)}(d_{t+1} + Q_{t+1})\right]} \quad (34.101)$$

One will note that (34.101) is exactly the same as the expression for the equity risk premium in the two period case, (34.20). The only difference relative to the two period case is that in the two period case we will have $Q_{t+1} = 0$, whereas in the three period case $Q_{t+1} \neq 0$ in general. Provided $d_{t+1} + Q_{t+1}$ covaries *negatively* with $u'(Y_{t+1})$ (i.e. the payout from the stock is procyclical), investors will demand a higher yield to hold the stock in comparison to the risk-free bond (i.e. the equity premium will be positive).

Let us now do a couple of quantitative experiments with actual numbers. Suppose that $\beta = 0.95$ and $Y_t = 1$. Let the utility function be the natural log. Suppose further that income in $t + 1$ and $t + 2$ can take on the same two values, $Y_{t+1}^h = Y_{t+2}^h = 1.1$ and $Y_{t+1}^l = Y_{t+2}^l = 0.90$. For now, assume that the dividend payout on the stock can take on the same two values in both future periods: $d_{t+1}^h = d_{t+2}^h = 1.1$ and $d_{t+1}^l = d_{t+2}^l = 0.90$. It remains to specify the probabilities of different states materializing, which in a three period context can become somewhat messy. Let us suppose the following probability structure in $t + 1$: $p_1 = p_3 = 0.4$ and $p_2 = p_4 = 0.1$. This means that there is a 50 percent chance of the $t + 1$ income being high ($p_1 + p_2$), and a 50 chance of the dividend being high ($p_1 + p_4 = 0.5$). Furthermore, we assume that *conditional* on whatever state materializes in $t + 1$, there is a 60 percent chance of that same state materializing in $t + 2$. Conditional on whatever state materializes in $t + 1$, there is a 20 percent chance of the state “flipping” (i.e. going from e.g. (h, l) to (l, h) or (h, h) to (l, l)). There is a 10 percent chance of going to the other two possible states conditional on the realization of the state in $t + 1$ (i.e. the probability of going from (h, h) to (h, l) or (l, h) is 0.1 each).³ This means that we are assuming some *persistence* – whatever state

³Formally, this means we are assuming $p_1 = p_3 = 0.4$, $p_2 = p_4 = 0.1$, $q_1 = q_{11} = 0.24$, $q_2 = q_4 = q_{10} = q_{12} = 0.04$, $q_3 = q_9 = 0.08$, $q_5 = q_7 = q_{13} = q_{15} = 0.01$, $q_6 = q_{16} = 0.06$, and $q_8 = q_{14} = 0.02$.

materializes in $t + 1$ is relatively more likely to materialize in $t + 2$.

Table 34.2: Stock and Bond Pricing: Three Periods

	(1)	(2)	(3)	(4)
P_t	0.96	0.95	0.96	0.96
Q_t	1.86	1.85	1.87	2.05
$1 + r_t$	1.042	1.053	1.042	1.042
$1 + r_{s,t}$	1.049	1.053	1.045	1.049
$r_{s,t} - r_t$	0.007	0.000	0.003	0.007
$\mathbb{E}[P_{t+1}]$	0.96	0.95	0.96	0.96
$\mathbb{E}[Q_{t+1}]$	0.95	0.95	0.96	1.05
$\mathbb{E}[Y_{t+1}]$	1	1	1	1
$\mathbb{E}[Y_{t+2}]$	1	1	1	1
$\mathbb{E}[Y_{t+2} Y_{t+1}^h]$	1.04	1	1.04	1.04
$\mathbb{E}[Y_{t+2} Y_{t+1}^l]$	0.96	1	0.96	0.96
$\mathbb{E}[d_{t+1}]$	1	1	1	1
$\mathbb{E}[d_{t+2}]$	1	1	1	1
$\mathbb{E}[d_{t+1} Y_{t+1}^h]$	1.06	1	1	1.16
$\mathbb{E}[d_{t+1} Y_{t+1}^l]$	0.94	1	1	1.04
$\mathbb{E}[d_{t+2} Y_{t+2}^h]$	1.036	1	1	1.136
$\mathbb{E}[d_{t+2} Y_{t+2}^l]$	0.964	1	1	1.064

Table 34.2 presents information from numerical experiments under several different scenarios described in column headings. Case (1) is the base case as described above. The bond yields about 4.2 percent, and the stock about 4.9 percent. As such, the equity premium is roughly 0.7 percent. The numbers are chosen such that the unconditional expectations of both dividends and income are all the same at 1. But conditional on income being high in $t + 1$, the expected value of income in $t + 2$ is higher than the unconditional expectation (1.04). Similarly, conditional on income being low in $t + 1$, the expectation of income in $t + 2$ is lower than the unconditional expectation (0.96). This is a feature of the assumed persistence. In both $t + 1$ and $t + 2$, the dividend payout is positively correlated with income. Conditional on income being high in $t + 1$, for example, the expected dividend is 1.06, whereas conditional on income being low, the expected dividend is 0.94. A similar pattern emerges, though not as stark, for $t + 2$. Note that the expected value of the future stock price is *lower* than the current value of the stock price. This is an artifact of our assumption of a finite number of periods – in period t , the stock is a claim on two dividend payments of equal magnitude in expectation, whereas in $t + 1$ a share of stock is a claim on only one dividend payment. It is therefore natural in this example that $Q_t > \mathbb{E}[Q_{t+1}]$.

Column (2) considers a case in which there is no uncertainty over future income – that is, $Y_{t+1}^h = Y_{t+1}^l = Y_{t+2}^h = Y_{t+2}^l = 1$. The probabilities are the same and the dividend values are the same. The bond has a higher yield in this case. The reason for this relates back to precautionary saving – if there is no income uncertainty, there is less demand for the bond, and hence it trades at a lower price and higher yield compared to the case with uncertainty. We see that the stock has the same expected return as the bond; there is no equity premium. There is no equity premium because there is no covariance between stock returns and the marginal utility of consumption if there is no uncertainty over income/consumption.

Column (3) considers the case where there is income uncertainty, as in our base case (1), but assumes that there is no uncertainty over the future dividend, so $d_{t+1}^h = d_{t+1}^l = d_{t+2}^h = d_{t+2}^l = 1$. The bond price and yield are identical to the base case, (1). However, even though there is no dividend uncertainty, the stock still commands a higher yield than the bond, with an implied equity premium of about 0.3 percent. If there is no covariance between dividend payments and the marginal utility of consumption, why is there an equity premium? The reason is that there is in effect a maturity difference between the bond and the stock. The stock has a two period maturity, the bond a one period maturity. Since the stock pays a constant and known dividend, the stock in this example is isomorphic to a two period bond. For the same reasons we encountered in Chapter 33, uncertainty over income means there is a term premium. Hence, the stock trades at a higher yield than the one period risk-free bond. Column (3) reveals an important point. In reality, stocks are securities with *no maturity*, as corporations can exist in perpetuity. This means that a stock that pays a very consistent dividend (what is sometimes called an “income stock”) ought to trade at a fairly similar yield to *long maturity* government bonds.

The final case considered, labeled (4), is one in which the expected value of dividends in both $t + 1$ and $t + 2$ is 1.1 instead of 1, but is otherwise identical to case (1). This has the effect of resulting in a higher stock price, but has no effect on the yields of the bond and the stock or the equity premium. The equity premium arises because of covariance between dividends and future income, not the expected level of future income.

Moving to more than three periods is reasonably straightforward. As long as there are at least two periods, for any stock the pricing condition can be written as:

$$Q_t = \mathbb{E} \left[\frac{\beta u'(C_{t+1})}{u'(C_t)} (d_{t+1} + Q_{t+1}) \right] \quad (34.102)$$

The price today is simply the expectation of the product of the stochastic discount factor with the cash flows generated by the stock. If time lasts for three or more periods, as in the example above, note that the expression for Q_{t+1} will be the same as (34.102), just led

forward one period:

$$Q_{t+1} = \mathbb{E}_{t+1} \left[\frac{\beta u'(C_{t+2})}{u'(C_{t+1})} (d_{t+2} + Q_{t+2}) \right] \quad (34.103)$$

(34.103) can be plugged into (34.102) as we did above to give:

$$Q_t = \mathbb{E} \left[\frac{\beta u'(C_{t+1})}{u'(C_t)} \left(d_{t+1} + \mathbb{E}_{t+1} \left[\frac{\beta u'(C_{t+2})}{u'(C_{t+1})} (d_{t+2} + Q_{t+2}) \right] \right) \right] \quad (34.104)$$

This process can be continued by noting that, for any arbitrary number of periods into the future, $j \geq 1$, we must have:

$$Q_{t+j} = \mathbb{E}_{t+j} \left[\frac{\beta u'(C_{t+j+1})}{u'(C_{t+j})} (d_{t+j+1} + Q_{t+j+1}) \right] \quad (34.105)$$

Suppose that time continues until period T (i.e. there are T periods subsequent to the present period t). If we successively substitute (34.105) into (34.104), and make use of the Law of Iterated Expectations, we can write:

$$Q_t = \mathbb{E} \left[\sum_{j=1}^T m_{t,t+j} d_{t+j} \right] + \mathbb{E} [m_{t,t+T} Q_{t+T}] \quad (34.106)$$

Where once again $m_{t,t+j} = \frac{\beta^j u'(C_{t+j})}{u'(C_t)}$ is the stochastic discount factor between t and $t+j$. As long as T is finite, a terminal condition should be satisfied such that $Q_{t+T} = 0$. This condition simply says that the stock is worthless in the final period. Since the stock is a claim on future dividends, if there is no future, the stock should not trade for a positive price in the final period. Imposing this terminal condition allows us to write:

$$Q_t = \mathbb{E} \left[\sum_{j=1}^T m_{t,t+j} d_{t+j} \right] \quad (34.107)$$

In other words, the stock price should be the expected present discounted value of future dividends. Discounting is by the stochastic discount factor, which, if there is uncertainty, will differ from the yield on the risk-free bond.

34.3.1 The Gordon Growth Model

The [Gordon Growth Model](#) is a famous stock pricing equation that is a special case of (34.107). It result in an intuitive and easy to understand pricing equation that provides a number of useful insights.

Suppose that the stochastic discount factor varies only with the horizon. In particular,

suppose that $m_{t,t+j} = \left(\frac{1}{1+r}\right)^j$. This would obtain if, for example, the endowment were constant, so that $m_{t,t+j} = \beta^j$. Suppose further that dividends grow at a constant rate, g . There is no uncertainty in the dividend process. In particular:

$$D_{t+1} = (1 + g)D_t \quad (34.108)$$

Iterating (34.108) forward, we get:

$$D_{t+j} = (1 + g)^j D_t \quad (34.109)$$

Let the household live forever, so $T \rightarrow \infty$. Under these assumptions, the stock price can be solved for using (34.107):

$$Q_t = \sum_{j=1}^{\infty} \left(\frac{1+g}{1+r}\right)^j D_t \quad (34.110)$$

Using facts about infinite sums, this can be written:

$$Q_t = D_t \frac{1}{1 - \frac{1+g}{1+r}} \quad (34.111)$$

(34.111) can be written:

$$Q_t = \frac{(1+g)D_t}{r-g} \quad (34.112)$$

(34.112) tells us that a stock price depends positively on the level of its dividends, D_t ; positively on the growth rate of dividends, g ; and negatively on the discount rate, r . One can divide both sides by D_t to write this as a price-dividend ratio (which ought to be reasonably closely-related to a price-earnings ratio):

$$\frac{Q_t}{D_t} = \frac{1+g}{r-g} \quad (34.113)$$

While (34.113) only holds under special circumstances, it provides a couple of important insights. Price-dividend ratios can vary (either across time or across stocks) with the growth rate of dividends and the discount rate. Young startup companies may pay little or no dividend at present, but they may have fast expected growth (i.e. high g). We therefore would expect such companies to have a high price-dividend ratio relative to more mature companies which might have high current earnings but weaker long run earnings potential. The riskier is a stock (i.e. the more its payouts covary with the stochastic discount factor), the higher should be the discount rate applied to the stock, and hence such a stock should

trade at a comparatively low price-dividend ratio. Finally, decreases in interest rates in the economy as a whole ought to generally be good for stock prices – as we can see in (34.113), a decline in r results in a higher Q_t for a given D_t .

34.4 Bubbles and the Role of the Terminal Condition

The term “bubble” is often used in popular parlance to describe the behavior of the stock market (or markets for other assets, such as land or housing). In popular usage, “bubble” seemingly just refers to a situation in which an asset’s price is high (and rising) without observable changes in cash flows from the asset.

Economists have a more precise definition of the term bubble. In particular, in (34.106) the “bubble” component of the price is defined as the expected discounted value of the stock price in the final period of time, while the “fundamental” component is the expected presented discounted value of the stream dividends. Concretely:

$$Q_t = \underbrace{\mathbb{E} \left[\sum_{j=1}^T m_{t,t+j} d_{t+j} \right]}_{\text{Fundamental}} + \underbrace{\mathbb{E} [m_{t,t+T} Q_{t+T}]}_{\text{Bubble}} \quad (34.114)$$

Which we can write more compactly as:

$$Q_t = Q_t^F + Q_t^B \quad (34.115)$$

When working above, we ruled the bubble term out, setting $Q_t^B = 0$. What allowed us to do so was the idea that, in the final period, any asset should have a zero price, so $Q_{t+T} = 0$. Again, the intuition for this is that the share of stock is a claim to future dividends; in period $t + T$, there is no future, and hence no one should be willing to pay a positive price for the asset. If $Q_{t+T} = 0$, then $Q_t^B = 0$, and the period t price of the asset is simply the fundamental component, which is the presented discounted value of the stream of dividends where discounting is by the stochastic discount factor. A general point which we can conclude from this discussion is that one should not observe bubbles (as economists have defined the term) for assets with a finite life span / maturity (such as almost all bonds).

But in reality, stocks differ from bonds in that there is no maturity for a stock. In principle, a company exists in perpetuity. This suggests that we should let $T \rightarrow \infty$, so that time never ends. If this is the case, then (34.114) may be written:

$$Q_t = \underbrace{\mathbb{E} \left[\sum_{j=1}^{\infty} m_{t,t+j} d_{t+j} \right]}_{\text{Fundamental}} + \underbrace{\lim_{T \rightarrow \infty} \mathbb{E} [m_{t,t+T} Q_{t+T}]}_{\text{Bubble}} \quad (34.116)$$

We can still express (34.116) by (34.115), but unlike the case where T is finite, we cannot necessarily rule the bubble term out. Why is this? If there is no end of time, then there is no reason to think that the price of the stock will ever be zero. But if we can never say that the stock has zero value, we cannot necessarily conclude that $Q_t^B = 0$.

Even if we cannot necessarily rule bubbles out, we can say something about how bubbles must evolve. Recall that the period t price of the stock can be written:

$$Q_t = \mathbb{E}[m_{t,t+1}(d_{t+1} + Q_{t+1})] \quad (34.117)$$

(34.117) can be written:

$$Q_t = \mathbb{E}[m_{t,t+1}d_{t+1}] + \mathbb{E}[m_{t,t+1}Q_{t+1}] \quad (34.118)$$

Now, using (34.115), (34.118) may be written:

$$Q_t^F + Q_t^B = \mathbb{E}[m_{t,t+1}d_{t+1}] + \mathbb{E}[m_{t,t+1}Q_{t+1}^F] + \mathbb{E}[m_{t,t+1}Q_{t+1}^B] \quad (34.119)$$

But note that $Q_t^F = \mathbb{E}[m_{t,t+1}d_{t+1}] + \mathbb{E}[m_{t,t+1}Q_{t+1}^F]$. Hence:

$$Q_t^B = \mathbb{E}[m_{t,t+1}Q_{t+1}^B] \quad (34.120)$$

Assume that the bubble term is uncorrelated with the stochastic discount factor. This means that the expectation of the products on the right hand side of (34.120) is the product of the expectations. This allows us to write:

$$\mathbb{E}[Q_{t+1}^B] = (\mathbb{E}[m_{t,t+1}])^{-1} Q_t^B \quad (34.121)$$

The stochastic discount factor will ordinarily be less than one, so its inverse will be greater than one. (34.121) then tells us that, if a bubble exists ($Q_t^B \neq 0$), it must be expected to *grow*. Furthermore, it must be expected to grow at the inverse of the stochastic discount factor (i.e. the growth rate of the bubble term ought to equal the yield on a one period riskless bond). Intuitively, if $Q_t^B > 0$ (note it could also be negative), then one would be paying *more* than the stock's fundamental value to purchase that stock. One would only be willing to pay than the fundamental value of the stock if one expects that someone else in the future will overpay by *even more*. Put somewhat more colloquially, you might be willing to behave foolishly if you think there is a greater fool out there.

Note that a stock with a bubble component does *not* offer a higher expected return (adjusting for risk) compared to a stock without a bubble. To see this clearly, let us consider a particularly simple example. Suppose that current and future dividends are fixed at

one. Suppose further that the current and future endowments are also fixed at one. This means that $m_{t,t+1} = \beta$ and there is no uncertainty over the stochastic discount factor. The fundamental value of the stock is simply the present value of the constant dividend payout, which under these assumptions is just:

$$Q_t^F = \sum_{j=1}^{\infty} \beta^j \quad (34.122)$$

Using facts about infinite sums, this simply works out to $\frac{\beta}{1-\beta}$. Since the dividend is constant and the endowment is constant as well, the fundamental stock price will be constant throughout time. The expected (gross) return from holding the stock from t to $t+1$ without a bubble (over which there is no uncertainty) is simply:

$$R_{t+1} = \frac{D_{t+1} + Q_{t+1}}{Q_t} = \frac{1 + \frac{\beta}{1-\beta}}{\frac{\beta}{1-\beta}} = \frac{1}{\beta} \quad (34.123)$$

In other words, the expected return is just β^{-1} , the inverse of the stochastic discount factor (which would be the same as a yield on a one period bond). Now suppose that the stock is in a bubble, with $Q_t^B > 0$. Suppose that the bubble continues with probability p and bursts (goes to zero) with probability $1-p$. Since a bubble must grow in expectation, from (34.121), the realized value of the bubble in $t+1$ if it continues must satisfy:

$$pQ_{t+1}^B + (1-p)0 = \frac{1}{\beta}Q_t^B \quad (34.124)$$

If the bubble continues, the price in $t+1$ will be $Q_{t+1} = \frac{\beta}{1-\beta} + \frac{1}{\beta p}Q_t^B$. If it bursts, the price will be $Q_{t+1} = \frac{\beta}{1-\beta}$. The expected return on the stock (which is no longer certain) is therefore:

$$\mathbb{E}[R_{t+1}] = \frac{D_{t+1} + \mathbb{E}[Q_{t+1}]}{Q_t} = \frac{1 + p\left(\frac{\beta}{1-\beta} + \frac{1}{\beta p}Q_t^B\right) + (1-p)\frac{\beta}{1-\beta}}{\frac{\beta}{1-\beta} + Q_t^B} \quad (34.125)$$

Simplifying (34.125), we obtain:

$$E[R_{t+1}] = \frac{\frac{1}{1-\beta} + \frac{1}{\beta}Q_t^B}{\frac{\beta}{1-\beta} + Q_t^B} \quad (34.126)$$

(34.126) can be written:

$$E[R_{t+1}] = \frac{1 + \frac{1-\beta}{\beta}Q_t^B}{\beta + (1-\beta)Q_t^B} \quad (34.127)$$

But (34.127) may be written:

$$E[R_{t+1}] = \frac{\frac{1}{\beta} (\beta + (1 - \beta)Q_t^B)}{\beta + (1 - \beta)Q_t^B} = \frac{1}{\beta} \quad (34.128)$$

In other words, for any value of Q_t^B , the expected gross return on the stock is just $\frac{1}{\beta}$. Hence, the stock being in a bubble does not offer high *expected returns*. What it does do is increase the volatility of realized returns. If there is no bubble, in this particular example the return is *always* $\frac{1}{\beta}$. If there is a bubble, with probability p the return will be higher than this and with probability $1 - p$ the return will be lower. For example, suppose that $\beta = 0.95$. If there were no bubble, the return would be constant at 1.0526. Suppose that there is a bubble of $Q_t^B = 1$ and $p = 0.8$ (i.e. the bubble continues with 80 percent probability). If the bubble continues, the realized return works out to 1.0658, whereas if the bubble burst the realized (gross) return is 1 (so a net return of 0). The average of these is $0.8 \times 1.0658 + 0.2 \times 1 = 1.0526$, the same as the return would be with no bubble. A stock with a bubble component does not offer a high return in expectation; it offers a high return if the bubble continues and a low return if the bubble bursts. Bubbles increase the volatility of returns, but not the level of returns in an average sense.

34.4.1 A Numerical Example with Bubbles

Let us explore a somewhat more complicated numerical example. Doing so will give us some guidance on how one might detect bubbles in the data.

Suppose that the representative household is infinitely-lived and has a discount factor of $\beta = 0.95$. The utility function is the natural log. Suppose that the household's endowment is *constant* at one. This means there is no risk premium for equity over riskless debt. This is not critical but simplifies the computation.

Suppose that shares of a stock pay dividends according to the following stochastic process:

$$d_t = (1 - \rho)\bar{d} + \rho d_{t-1} + \varepsilon_{d,t}, \quad 0 \leq \rho < 1, \quad \varepsilon_{d,t} \sim N(0, s^2) \quad (34.129)$$

$\varepsilon_{d,t}$ is a stochastic shock drawn from a normal distribution with zero mean and standard deviation of s (the variance is s^2). The process has an unconditional mean of \bar{d} . Conditional on dividends observed in t , the expected value of dividends in the next period is $\mathbb{E}_t d_{t+1} = (1 - \rho)\bar{d} + \rho d_t$. ρ is a measure of the persistence in the process for dividends. $\rho > 0$ means that $d_t > \bar{d}$ is associated with $\mathbb{E}_t d_{t+1} > \bar{d}$ – i.e. if dividends are higher than average today, you will expect them to be higher than average tomorrow as well.

If the endowment is constant and consumption must equal income each period, then the stochastic discount factor is $m_{t,t+j} = \beta^j$. This significantly simplifies the analysis. Making use

of this, we can write the price of a share of stock as:

$$Q_t = \mathbb{E}[\beta(d_{t+1} + Q_{t+1})] \quad (34.130)$$

We can again split this into two components – the fundamental component and the bubble component. The fundamental component is the present value of dividends;

$$Q_t^F = \sum_{j=1}^{\infty} \beta^j \mathbb{E}_t d_{t+j} \quad (34.131)$$

The expectation of future d_{t+j} given a current d_t is:

$$\mathbb{E}_t d_{t+j} = \bar{d} + \rho^j (d_t - \bar{d}) \quad (34.132)$$

Plug (34.132) into (34.131) and re-arrange to get:

$$Q_t^F = \sum_{j=1}^{\infty} \beta^j \bar{d} + \sum_{j=1}^{\infty} (\beta\rho)^j (d_t - \bar{d}) \quad (34.133)$$

Using facts about infinite summations, this reduces to:

$$Q_t^F = \frac{\beta\bar{d}}{1-\beta} + \frac{\beta\rho(d_t - \bar{d})}{1-\beta\rho} \quad (34.134)$$

The bubble component must satisfy:

$$\mathbb{E}[Q_{t+1}^B] = \beta^{-1} Q_t^B \quad (34.135)$$

The actual price is:

$$Q_t = Q_t^F + Q_t^B \quad (34.136)$$

Let us first rule out the possibility of bubbles by setting $Q_t^B = 0$ at all horizons. We can generate a simulation of the stock price by simulating a process for dividends. Suppose that $\beta = 0.95$. Suppose further that $\bar{d} = 1$, $\rho = 0.98$, and $s = 0.02$. We simulate 1000 periods of dividends. At each point, we calculate the fundamental stock price using (34.134). A hypothetical time series of the stock price across 1000 periods is:

Figure 34.3: Simulated Stock Price: No Bubbles

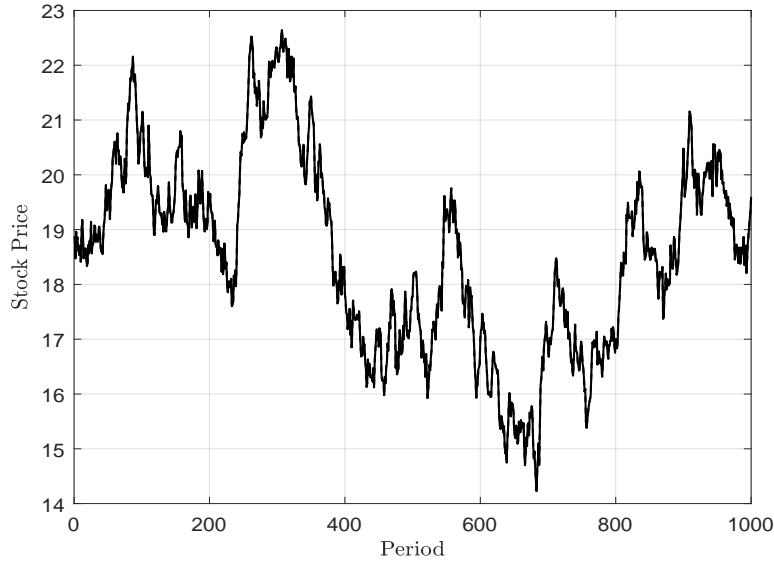

Stock prices fluctuate about a mean value of roughly 19. There are periods in the simulation that look a bit like the popular definition of a bubble – periods in which stock prices at first go up markedly and then down quickly (e.g. roughly period 525 to period 600 exhibits a sharp boom and then bust in the stock price). Yet Figure 34.3 is generated with no bubbles at all! This simple plot underscores an important point – it is difficult to identify bubbles even after the fact, much less in real time.

Next we re-do the simulation but allow for the possibility of exogenous and stochastic bubbles. Formally, we assume that the bubble term obeys a stochastic [Markov chain](#). In particular, we assume that there are three possible states – negative bubble, no bubble, and positive bubble. The economy begins in the no bubble state. In the subsequent period, there is a 95 percent chance of staying in the no bubble state, a 2.5 percent chance of entering a negative bubble, and a 2.5 percent chance of entering a positive bubble. If the economy moves from no bubble to a positive bubble in period t , then $Q_t^B = \frac{1}{2}$, and if it moves to a negative bubble, we have $Q_t^B = -\frac{1}{2}$. Once in a bubble state (either positive or negative), assume that there is a p probability of remaining in the bubble and a $1 - p$ probability of it “bursting” and returning to zero in the subsequent period. From above, recall that we must have $\mathbb{E}[Q_{t+1}^B] = \beta^1 Q_t^B$. With this setup, the value of the bubble term should it continue satisfies:

$$pQ_{t+1}^B + (1 - p)0 = \beta^{-1}Q_t^B \quad (34.137)$$

Or:

$$Q_{t+1}^B = \frac{1}{\beta p} Q_t^B \quad (34.138)$$

In other words, if the bubble continues, it must grow by a sufficient amount that in expectation it grows at β^{-1} . For example, if $\beta = 0.95$ and $p = 0.8$, then if $Q_t^B = 0.5$ we must have $Q_{t+1}^B = 0.6579$ should the bubble continue. This is growth of about 31 percent. This additional growth over and above $\frac{1}{\beta}$ is necessary to compensate the household for the possibility that the bubble bursts.

For our numerical simulation, we assume that $p = 0.8$. This means that, conditional on being in a bubble, there is a 80 percent chance of remaining in the bubble and a 20 percent chance of exiting. Figure 34.4 plots a simulated bubble process under these assumptions. During most periods, the bubble term is zero. There are periods in which it goes positive and negative. If it stays in the bubble, it grows (declines) very rapidly until the bubble bursts, when it immediately jumps back to zero. We observe a very large bubble term emerging around period 250 in the simulation. There are several other smaller bubbles (both negative and positive), though these are not as noticeable.

Figure 34.4: Simulated Bubble Process

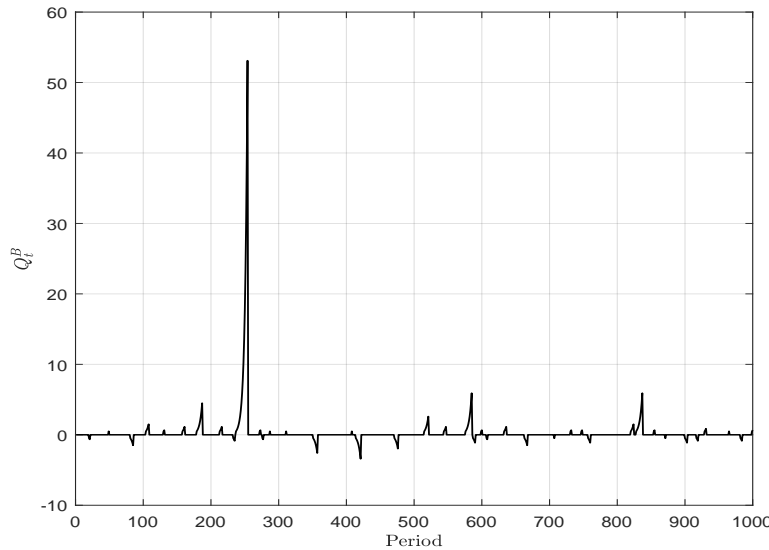
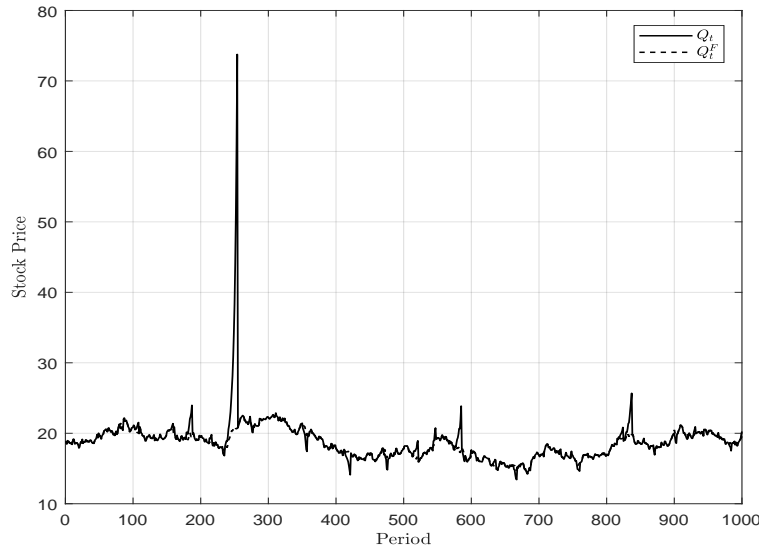

Figure 34.5 plots the simulated actual stock price, $Q_t = Q_t^F + Q_t^B$, along with the fundamental price, Q_t^F . During most periods these are quite similar, though they deviate from one another whenever $Q_t^B \neq 0$. The most noticeable such period is around period 250, which is a period of a very large and long-lasting positive bubble, as noted above.

Figure 34.5: Actual and Fundamental Stock Price



One would be tempted to look at the simulation in Figure 34.5 and conclude that spotting bubbles is fairly straightforward – simply look for periods where stock prices increase or decrease very rapidly. But in practice this may not be so easy and there are some specifics to this particular simulation. For example, if we were to increase the volatility or persistence of the dividend process (i.e. refer back to Figure 34.3), we could make the stock price series arbitrarily volatile and there might be many episodes which “look like” bubbles but are not.

Is there a more robust way to try to detect bubbles in past data? Economist [Robert Shiller](#) has popularized a simple measure based on price-earnings ratios (PE ratios) for the stock market as a whole. Empirically, the average PE ratio for the market as a whole is somewhere between 15 and 20. This would be broadly consistent with the simple Gordon Growth model described above if (i) dividends equal earnings, (ii) the discount rate is 7 percent, and (iii) the growth rate of dividends is 1.5 percent.⁴ Shiller noted that when the PE ratio is unusually high, this tends to be associated with stocks performing relatively poorly over the ensuing 20 years. The reverse is the case when the PE ratio is relatively low. Stock performance here is measured as the cumulative realized return over the ensuing 20 years, assuming all dividends are re-invested into the market. Figure 34.6 below plots a scatter plot of historical PE ratios with subsequent 20 year realized returns. There is a clear negative relationship evident in the data, with a correlation of about -0.35.

⁴In particular, using the Gordon Growth Model with these numbers, we’d get a ratio of price-dividends (equivalently earnings) of $\frac{1.015}{.07-.015} = 18.45$.

Figure 34.6: PE Ratio and Subsequent 20 Year Realized Return: S&P 500

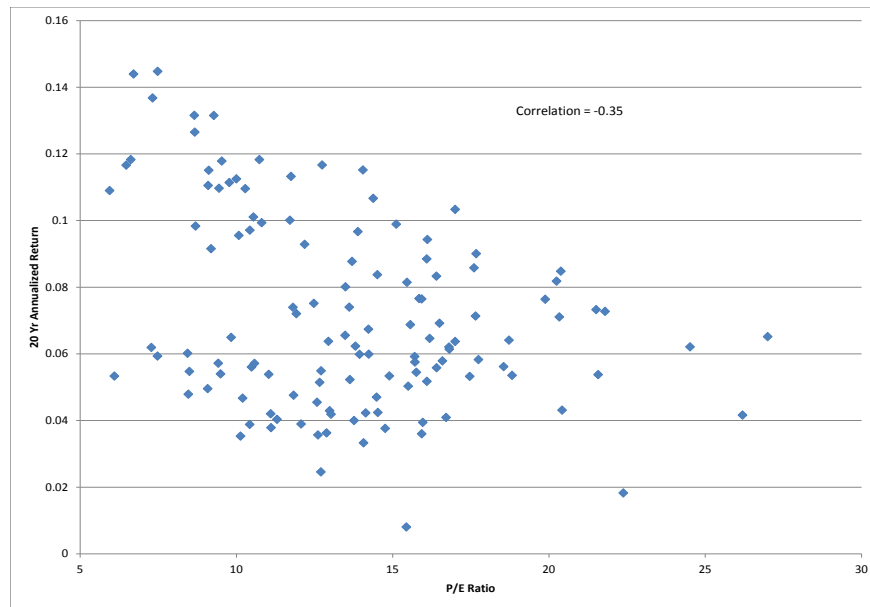

What is the logic behind why a negative correlation between future realized returns and current PE ratios may be indicative of bubbles? If a stock is experiencing a (positive) bubble, then it ought to trade at a comparatively high PE ratio (the reverse would be true for a negative bubble). While being in a bubble does not have a higher than average return in expectation, the bubble ought to burst at some point in the future, and when it does, the stock will suffer a large capital loss (or gain in the case of a negative bubble). For example, with a probability of a bubble continuing of p as described above, the probability of the bubble still being in place 20 periods later is p^{20} . With $p = 0.8$, this is about 1 percent. Hence, there is a 99 percent chance of the bubble having burst by a 20 year horizon, which means the owner of the stock will suffer a capital loss and hence a low realized return.

To see if such a test makes sense, we return to our simulation model described in this subsection. We assume, for the moment, that there are no bubbles. On the 1000 period simulation, for each of the first 980 periods, we calculate the realized return on holding the stock over the subsequent 20 periods. The realized return assumes dividends are reinvested.⁵ Figure 34.7 below plots a scatter plot of current price-dividend ratios in the model with subsequent realized twenty period (gross) returns. There is clearly *not* a negative relationship between price-dividend ratios and subsequent returns; in this particular sample of simulated

⁵To be clear, one could define the (realized) **holding period return** as the sum of cash flows over some horizon h relative to the current price of the security: $R_{t+h} = \left[\frac{\sum_{j=1}^h D_{t+j} + Q_{t+h}}{Q_t} \right]^{\frac{1}{h}}$. If one computes this, on average it will be declining for the horizon h because simply summing dividend payouts ignores compounding effects.

data, if anything the correlation looks positive.

Figure 34.7: Price-Dividend Ratio and Subsequent Realized Return: Model with No Bubble

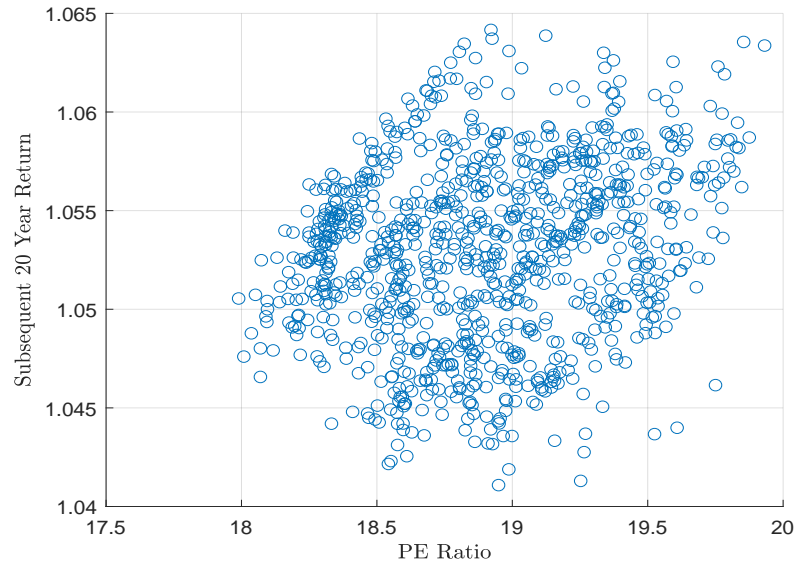

Next, we re-do the simulation but this time allow for bubbles with the same stochastic process as described above. Figure 34.8 plots the scatter plot between price-dividend ratios and subsequent realized twenty period returns. With bubbles included in the model simulation, we observe a clear negative relationship between price-dividend ratios and subsequent twenty period returns. The correlation in this particular sample is -0.63 . Periods of very high price-dividend ratios are associated with lower than average returns over the next twenty periods, while the reverse is true for periods of very low price-dividend ratios.

Figure 34.8: Price-Dividend Ratio and Subsequent Realized Return: Bubbles

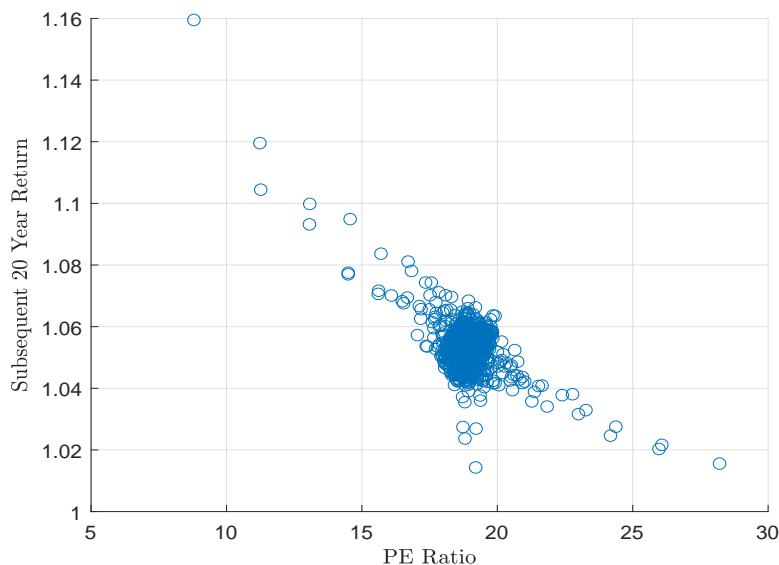

In the context of the simulation model employed here, it does seem necessary to include bubbles to match the correlation between PE ratios and subsequent realized returns found in the data. In retrospect and at least in an average sense, it seems possible to identify bubbles by periods of unusually high (or low) price-earnings ratios which are followed by unusually poor (or strong) returns. But this test only works *after the fact*. Detecting bubbles in real time is quite difficult.

34.4.2 Should Monetary Policy Attempt to Prick Bubbles?

In the wake of the collapse of the housing market in 2006 and 2007, many have argued that the Federal Reserve (and central banks more generally) should be tasked with stopping asset price bubbles before they get out of hand. Further, some have argued that central banks have been responsible for bubbles in the first place via monetary policies that are too easy.

The bursting of bubbles often has detrimental consequences beyond the decline in prices of particular classes of assets affected by a bubble. As we discuss further in Chapter 36, a decline in asset prices could set off a “run” on financial institutions when short term liability holders (e.g. depositors) become concerned about the value of the assets held by financial institutions. Such runs can be self-fulfilling and lead to widespread increases in credit market spreads and large reductions in economic activity. If asset price bubbles lead to runs and financial panics with widespread economic consequences, it would be best to try to avoid such bubbles in the first place.

A common argument is that central banks ought to adjust interest rates to prevent bubbles from occurring. John Taylor of Stanford university, for [example](#), has argued that the housing market bubble was driven by the Fed keeping its policy rate too low for too long in the early 2000s. It is easy to see why low interest rates can result in high asset prices (see, e.g., the Gordon Growth pricing condition above, (34.112)). It is less obvious why low interest rates could cause bubbles (which are exogenous in the context of the asset pricing model considered above), or why raising interest rates could prick bubbles,⁶ though it is commonly thought that bubbles are fueled by excessively easy credit (i.e. investors buying stocks on margin, or individuals buying houses with very low interest rate mortgages).

Our own view is that conventional monetary policy (by which we mean the adjustment of the monetary base and short term interbank lending rates) ought not to be in the business of trying to prick bubbles or to target asset prices more generally. First, the detection of bubbles in real time is extraordinarily difficult and fraught with hazards. Raising interest rates to prick what appears to be an asset price bubble but which is not might be quite costly. Second, interest rates affect credit decisions of all sorts of actors and sectors, many of which might be completely unrelated to the asset market exhibiting bubble behavior (e.g. raising interest rates to combat a suspected housing market bubble would affect the ability of corporations to issue commercial paper to cover short term financing needs, which is completely unrelated to real estate markets). Third, as hinted at above, it is not clear whether using monetary policy to manage bubbles would even be successful, or if doing so could actually exacerbate the problem of bubbles.

A better solution to the problem of asset price bubbles and their bursting seems to be along the lines of so-called [macroprudential regulation](#), which has come to the fore as a policy tool in the wake of the Great Recession. Macroprudential regulation differs from conventional regulation of financial institutions which is micro in nature (i.e. microprudential regulation). Macroprudential regulation focuses on the financial system as a whole, and seeks to enact policies which limit the extent to which the system as a whole is subject to systemic risk. Rather than trying to prick bubbles or prevent them from happening in the first place, macroprudential regulation seeks to make the financial system as a whole better able to withstand the bursting of asset price bubbles. Examples of macroprudential regulatory tools include time-varying capital ratios (the ratio of total equity to assets for financial institutions). During good times, institutions should have to build up buffers in the form of higher capital ratios, which makes them better able to withstand declines in asset values in a bust, and

⁶Indeed, one could make the argument that raising interest rates could *exacerbate* the problem of bubbles bursting. As documented above, under conventional theories bubbles must grow at the discount rate. Raising interest rates raises the discount rate on equity, and might cause bubbles (if they exist) to expand at an even faster rate, which would necessitate an even bigger decline in asset prices when the bubble eventually bursts.

therefore less likely to suffer runs. During bad times, financial institutions should face less stringent capital ratios, which ought to reduce their incentive to try to liquidate assets when facing funding difficulties. Another type of macroprudential regulatory tool focuses not so much on the level of total debt of a financial institution, but rather on its maturity structure. Short maturity debt is much more subject to runs than long maturity debt.

34.5 Equilibrium Stock Prices with Endogenous Production: the Neoclassical Model

In this Chapter we have discussed stock pricing in the context of an endowment economy. This simplifies the analysis and elucidates important insights. We close this chapter by returning to the neoclassical business cycle model, the microfoundations of which are developed in Chapter 12. Though we did not formally think about the value of shares of stock in the representative firm, we can do so, and will show how to incorporate this setup in this section. For what follows, let us abstract from uncertainty although allowing the future to be uncertain would not fundamentally change any of our results.

In Chapter 12, we wrote the flow budget constraints facing the household as (presented below with a slight modification of notation to be consistent with recent chapters):

$$C_t + B_t \leq w_t N_t + D_t \tag{34.139}$$

$$C_{t+1} \leq w_{t+1} N_{t+1} + D_{t+1} + (1 + r_t) B_t \tag{34.140}$$

In (34.139)-(34.140), B_t denotes the stock of one period bonds the household takes from t to $t + 1$; in the terminology of Chapter 33, we have normalized the period t price of these bonds to 1, with the face value given by $(1 + r_t)$. w_t and w_{t+1} are the period t and $t + 1$ real wages, N_t and N_{t+1} denote labor supply, and D_t and D_{t+1} measure dividend payouts from the household's ownership in the representative firm. D_t and D_{t+1} are taken as given.

In the presentation from Chapter 12 and given above, we do not allow the household to decide whether (or how much) of the firm's shares of stock to hold. As such, we cannot study the value of shares of stock in the firm. But this can easily be modified in such a way that we can price the firm's stock. Even with this modification, the other equilibrium prices and allocations will be identical to the setup in which we ignore this decision.

In (34.139), the only way for the household to transfer resources intertemporally is through savings bonds, B_t . We can instead modify the problem where the household can also save through accumulation of shares of stock in the firm. In particular, we can write the flow

budget constraints as:

$$C_t + B_t + Q_t(SH_t - SH_{t-1}) \leq w_t N_t + d_t SH_{t-1} \quad (34.141)$$

$$C_{t+1} + Q_{t+1}(SH_{t+1} - SH_t) + B_{t+1} \leq w_{t+1} N_{t+1} + d_{t+1} SH_t + (1 + r_t) B_t \quad (34.142)$$

In (34.141)-(34.142), SH_{t-1} denotes the shares of stock the household brings into period t . Because this was chosen in the past, it is exogenous with respect to period t . The household can choose a new value of shares, SH_t , to take from t to $t + 1$, and another value, SH_{t+1} , to take from $t + 1$ to $t + 2$. d_t and d_{t+1} denote dividend *rates*, reflecting the dividend payout per share. In terms of the notation from above, we would have $D_t = d_t SH_{t-1}$ and $D_{t+1} = d_{t+1} SH_t$. Q_t and Q_{t+1} denote the prices of shares of ownership in the firm, both of which the household take as given.

So as to simplify analysis, suppose that the household simply supplies one unit of labor inelastically in both periods, i.e. $N_t = N_{t+1} = 1$. Furthermore, let us impose the terminal conditions that $SH_{t+1} = 0$ (i.e. the household will not choose to die with any ownership stake in the firm) and $B_{t+1} = 0$ (i.e. the household will not choose to die with a positive stock of savings, and will not be allowed to die in debt). Imposing these terminal conditions as well as the normalizations on labor supply, the flow budget constraints simplify to:

$$C_t + B_t + Q_t(SH_t - SH_{t-1}) \leq w_t + d_t SH_{t-1} \quad (34.143)$$

$$C_{t+1} \leq w_{t+1} + (d_{t+1} + Q_{t+1}) SH_t + (1 + r_t) B_t \quad (34.144)$$

Lifetime utility for the household is standard:

$$U = u(C_t) + \beta u(C_{t+1}) \quad (34.145)$$

The household's objective is to pick SH_t and B_t so as to maximize (34.145), subject to (34.143)-(34.144). Imposing that the constraints hold with equality, we can write the unconstrained maximization problem as:

$$\max_{B_t, S_t} U = u[w_t + d_t SH_{t-1} - B_t - Q_t(S_t - SH_{t-1})] + \beta u[w_{t+1} + (d_{t+1} + Q_{t+1}) SH_t + (1 + r_t) B_t] \quad (34.146)$$

The first order optimality conditions are:

$$\frac{\partial U}{\partial B_t} = 0 \Leftrightarrow u'(C_t) = \beta u'(C_{t+1})(1 + r_t) \quad (34.147)$$

$$\frac{\partial U}{\partial SH_t} = 0 \Leftrightarrow Q_t u'(C_t) = \beta u'(C_{t+1})(d_{t+1} + Q_{t+1}) \quad (34.148)$$

(34.147) is the familiar consumption Euler equation. (34.148) implicitly defines the equilibrium share price of the firm as:

$$Q_t = \frac{\beta u'(C_{t+1})(d_{t+1} + Q_{t+1})}{u'(C_t)} \quad (34.149)$$

(34.150) is of course exactly the same (minus the fact that we are abstracting from uncertainty) as the general stock pricing expression derived above, (34.15). Imposing the no-bubble terminal condition that $Q_{t+1} = 0$, we simply get:

$$Q_t = \frac{\beta u'(C_{t+1})d_{t+1}}{u'(C_t)} \quad (34.150)$$

The firm is identical to what was presented in earlier chapters. It produces output using $Y_t = K_t^\alpha N_t^{1-\alpha}$, where we have fixed the value of the exogenous productivity variable to one for simplicity. The firm hires labor on a period-by-period basis at the market real wage. It begins with an initial stock of capital, K_t . It can accumulate new capital through investment, with $K_{t+1} = I_t + (1 - \delta)K_t$. We assume that any new investment must be financed with debt (as opposed to the issuance of new shares of stock). The number of existing shares, SH_{t-1} , is taken as given. Not allowing the firm to issue new shares requires that $SH_t = SH_{t-1}$.⁷

The total period t dividend that the firm returns to the household is simply output less payments to labor:

$$D_t = K_t^\alpha N_t^{1-\alpha} - w_t N_t \quad (34.151)$$

The firm must finance any investment in period t via borrowing, which must be paid back at $(1 + r_t)$ per unit borrowed in $t + 1$. Any capital left over after production in $t + 1$ is also returned to the household. The firm's total period $t + 1$ dividend is therefore:

$$D_{t+1} = K_{t+1}^\alpha N_{t+1}^{1-\alpha} - w_{t+1} N_{t+1} - (1 + r_t)(K_{t+1} - (1 - \delta)K_t) + (1 - \delta)K_{t+1} \quad (34.152)$$

The value of the firm, V_t , is equal to the sum of its current total dividend plus its share

⁷While it may seem restrictive to assume that the firm cannot issue new shares, recall from Chapter 12 that the Modigliani-Miller theorem holds in this model. That is, whether the firm finances its capital with debt or equity (issuing new shares) is irrelevant for what happens in the model.

price, Q_t , multiplied by the number of outstanding shares at the end of period t , SH_t . The period t dividend represents current income to the household, and Q_t represents how much the household values the claim on future dividends. Hence:

$$V_t = D_t + Q_t SH_t \quad (34.153)$$

Using (34.150), we can write (34.153) as:

$$V_t = D_t + \frac{\beta u'(C_{t+1}) d_{t+1}}{u'(C_t)} SH_t \quad (34.154)$$

But from (34.148), we know that $\frac{\beta u'(C_{t+1})}{u'(C_t)} = \frac{1}{1+r_t}$. Furthermore, $d_{t+1} SH_t = D_{t+1}$. Hence, we can write the total value of the firm as:

$$V_t = D_t + \frac{D_{t+1}}{1+r_t} \quad (34.155)$$

In other words, the value of the firm is simply the present discounted value of dividends. This is what we assumed in Chapter 12, but here it has been derived formally.

The firm's objective is to pick I_t (equivalently K_{t+1} , since K_t is taken as given), N_t , and N_{t+1} to maximize V_t subject to a standard law of motion for capital (i.e. $K_{t+1} = I_t + (1-\delta)K_t$). The optimality conditions for the firm are:

$$w_t = (1-\alpha)K_t^\alpha N_t^{-\alpha} \quad (34.156)$$

$$w_{t+1} = (1-\alpha)K_{t+1}^\alpha N_{t+1}^{-\alpha} \quad (34.157)$$

$$r_t + \delta = \alpha K_{t+1}^{\alpha-1} N_{t+1}^{1-\alpha} \quad (34.158)$$

As noted above, we are assuming that the household supplies one unit of labor inelastically in both periods, that the number of initial shares of stock in the firm is SH_{t-1} and is given, and that the number of shares outstanding does not change going from t to $t+1$. We can therefore assume as a normalization that $SH_{t-1} = SH_t = 1$ (i.e. there is one share outstanding), which means that there is no distinction between the dividend rate, d_t , and the total dividend payout, D_t . Since in equilibrium $B_t = I_t$, and $I_{t+1} = -(1-\delta)K_{t+1}$ (i.e. the firm liquidates itself after production in $t+1$), the aggregate resource constraints work out in the standard way – $Y_t = K_t^\alpha = C_t + I_t$ and $Y_{t+1} = K_{t+1}^\alpha = C_{t+1} + I_{t+1}$. Using the optimality condition for period $t+1$ labor demand, the period $t+1$ dividend can be written:

$$D_{t+1} = K_{t+1}^\alpha - (1-\alpha)K_{t+1}^\alpha + (1-\delta)K_{t+1} - (1+r_t)(K_{t+1} - (1-\delta)K_t) \quad (34.159)$$

Which can be written:

$$D_{t+1} = \alpha K_{t+1}^\alpha + (1 - \delta)K_{t+1} - (1 + r_t)K_{t+1} + (1 + r_t)(1 - \delta)K_t \quad (34.160)$$

Using (34.158), this can be written:

$$D_{t+1} = (r_t + \delta)K_{t+1} + (1 - \delta)K_{t+1} - (1 + r_t)K_{t+1} + (1 + r_t)(1 - \delta)K_t \quad (34.161)$$

But the terms involving (34.161) involving K_{t+1} drop out, leaving:

$$D_{t+1} = (1 + r_t)(1 - \delta)K_t \quad (34.162)$$

But this means that the equilibrium share price of the firm is:

$$Q_t = (1 - \delta)K_t \quad (34.163)$$

The share price, which represents what the household is willing to pay to own a share of stock in the firm, is simply equal to the *end-of-period* capital stock of the firm, $(1 - \delta)K_t$. If you stop to think about it, it makes a lot of sense that this is the equilibrium share price of the firm. The firm is nothing more than a collection of capital. Capital within period t is “stuck” in the firm. After production in period t takes place, there is $(1 - \delta)K_t$ left over. If the firm liquidated itself at the end of period t (instead of period $t + 1$), the firm could return $(1 - \delta)K_t$ to the household in period t . It therefore makes sense that this is what the household would be willing to pay for the firm. If $Q_t < (1 - \delta)K_t$, the household would like to buy more shares in the firm, but the number of shares are fixed. If $Q_t > (1 - \delta)K_t$, in contrast, the household would like to sell shares, which would involve liquidating the firm. Since the number of shares is fixed by assumption, it must be the case that the firm’s stock price is $(1 - \delta)K_t$ for the household to be indifferent between selling or buying shares in the firm. Stockholder’s equity is defined as the market-value of a firm times the number of shares outstanding. Since we have fixed the number of shares outstanding at 1, stockholder’s equity is simply the share price, Q_t . This is simply equal to the end-of-period capital stock. This is another manifestation of why the terms equity and capital are often used interchangeably.

34.6 Summary

- The ownership of a stock entitles the owner to current and future profits of the company. Because stocks offer volatile dividends over an infinite horizon and stockholders are junior claimants, stocks are riskier than bonds in general.

- Because dividend payments and stock prices are likely to be high when consumption is high, equity returns are negatively correlated with the stochastic discount factor. This generates a positive equity premium.
- A price of a stock should equal the expected present discounted value of future dividends where the dividends are discounted by the stochastic discount factor.
- Under some special circumstances the stock pricing formula reduces to a function of the the growth rate of the dividend, the interest rate, and the dividend.
- According to our theory, securities with finite maturities (e.g. most bonds) do not have bubbles because no one would pay for them after their maturity date. Stocks, in contrast, can have bubbles.
- Identifying bubbles is very difficult in practice. That said, our model predicts that the price to earnings ratio might be a good indicator of a potential bubble.
- While arguments can be made for using conventional monetary policy to prick bubbles, an attractive alternative is macroprudential regulation which focuses on the financial system as a whole.

Key Terms

1. Stock
2. Dividends
3. Equity premium
4. Stochastic discount factor
5. Gordon Growth Model
6. Bubble
7. Macroprudential regulation.

Questions for Review

1. Why are stocks riskier than bonds in general?
2. According to the Gordon Growth Model, what factors influence the price to dividend ratio?
3. How does the economist's definition of a bubble differ from the definition in common parlance?

4. Explain how bubbles influence the expected returns of stocks. How do they affect the variance of expected returns?
5. Why might a monetary policy maker want to prick an asset price bubble before it gets out of hand? What are some barriers to doing this?
6. What are some types of macroprudential regulation?

Chapter 35

Financial Factors in a Macro Model

Standard macroeconomic models suitable for short and medium run analysis mostly abstract from issues related to finance and banking. For example, in motivating the underlying decision rules of both the neoclassical and New Keynesian models, we assumed that firms had to finance investment via borrowing from a financial intermediary, but this intermediary played an extremely passive role. Further, the Modigliani-Miller theorem held and we could have alternatively dispensed with financial intermediation altogether without altering the equilibrium decision rules.

Especially in the wake of the Financial Crisis / Great Recession of 2007-2009, macroeconomists (and macroeconomic models) have been heavily criticized for failing to incorporate frictions related to financial intermediation in a compelling way. While recent history has certainly proven this criticism valid, it is easy to understand why macroeconomic models typically do not feature particularly sophisticated financial structures. For financial intermediation to be valuable, there must be non-trivial heterogeneity in place, and it is difficult to model significant heterogeneity in a tractable way. Financial intermediation is a form of *indirect* finance, as discussed in Chapter 30. Households do not wish to *directly* finance the operations of firms because there are informational frictions (adverse selection and moral hazard). But for there to be informational frictions, there must be different types of firms, so there must be some heterogeneity. While it is conceptually straightforward to think about how such heterogeneity impacts individual decision rules, it is not so straightforward to incorporate it into a general equilibrium description of an economy as a whole.

In spite of these challenges, we wish to return to our core model used to study medium and short run fluctuations, yet do so in a way that can speak to financial frictions and shocks. To that end, we will incorporate a *credit spread* variable into the analysis. In particular, we will assume that the (real) interest rate relevant for the representative household is r_t , while the real interest rate relevant for the representative firm is $r_t + f_t$, where f_t is the spread. Based on our work in Chapter 33, we can alternatively think of f_t as a term or risk premium (or both), though for the most part we will treat it as exogenous. We can think about a financial crisis as a situation in which f_t rises markedly. In a crisis (see e.g. Chapter 32), there is high demand for short term, liquid securities (like cash). This makes it difficult

for financial intermediaries to lend to firms, resulting in increasing interest costs to firms of obtaining credit. This results in a collapse in investment and aggregate demand, and graphically serves as an additional shock to the IS curve.

We can also consider (partially) endogenizing the credit spread variable. We refer to this as the “financial accelerator” model after [Bernanke, Gertler, and Gilchrist \(1999\)](#). In this framework, credit spreads endogenously move countercyclically with output. The logic behind this is simple: if default risk is highest when output is low, it stands to reason that credit spreads are high when output is low. This financial accelerator mechanism has the effect of amplifying the output effects of both demand and supply shocks.

35.1 Incorporating an Exogenous Credit Spread

We return to the model used to study short and medium run fluctuations but add one simple twist. In particular, recall the set of equations underlying the Neoclassical model (Chapter 17) or the New Keynesian model (Chapter 25). The equilibrium consists of decision rules for consumption, labor supply, money demand, and investment demand; an aggregate resource constraint and the Fisher relationship; and an equation characterizing aggregate supply as a function of the nominal price of goods. The eight equations characterizing the equilibrium are shown below in (35.1)-(35.8).

$$C_t = C^d(Y_t - G_t, Y_{t+1} - G_{t+1}, r_t) \quad (35.1)$$

$$N_t = N^s(w_t, \theta_t) \quad (35.2)$$

$$P_t = \bar{P}_t + \gamma(Y_t - Y_t^f) \quad (35.3)$$

$$I_t = I^d(r_t + f_t, A_{t+1}, K_t) \quad (35.4)$$

$$Y_t = A_t F(K_t, N_t) \quad (35.5)$$

$$Y_t = C_t + I_t + G_t \quad (35.6)$$

$$M_t = P_t M^d(r_t + \pi_{t+1}^e, Y_t) \quad (35.7)$$

$$r_t = i_t - \pi_{t+1}^e \quad (35.8)$$

The most general form of these equations is presented, with (35.3) being the aggregate supply (AS) curve. It summarizes a couple of special cases. When $\gamma \rightarrow \infty$, we must have $Y_t = Y_t^f$ and the model collapses to the Neoclassical Model. When $\gamma = 0$, in contrast, we have the simple sticky price model. For values of γ lying in between we have the partial sticky price model. The endogenous variables are Y_t , C_t , I_t , N_t , w_t , r_t , i_t , and P_t . Exogenous variables

are G_t , G_{t+1} , A_t , A_{t+1} , θ_t , \bar{P}_t , and π_{t+1}^e . The new variable is the credit spread variable, f_t , and it is taken to be exogenous.

The only difference relative to earlier presentations of the model is the inclusion of an additional exogenous variable, f_t . It appears in the investment demand equation, (35.4). In particular, we assume that the (real) interest rate relevant for investment decisions is $r_t + f_t$. We can think about r_t as the risk-free short run interest rate and f_t as the premium the firm pays over this to borrow funds for investment. As in Chapter 33, this premium can be thought of either as a risk or as a term premium, or a risk and term premium rolled together into one. Because of the simplified nature of the two period model, it is difficult to formally motivate it as such, however. With only two periods, there would be no term premium. And with a representative firm that never defaults in equilibrium, there would be no risk premium either. To formally motivate a variable like f_t , we would need to extend the model beyond two periods and allow for heterogeneity on the firm side, both of which would involve serious complications.

Instead, we will simply treat f_t as exogenous. We can come up with an empirical counterpart to f_t by measuring the spread between the average yield on risky corporate debt (debt rated by Moody's as Baa) relative to the yield on a Treasury of similar maturity (10 years). A time series of this variable is plotted below in Figure 35.1. We observe that this credit spread appears quite countercyclical (i.e. it rises around times identified as recessions, most notably during the financial crisis / Great Recession of 2007-2009). Whether this increase in credit spreads is a cause or a consequence of cyclical fluctuations is not immediately obvious, and it may well be both. In fact, in what follows we will consider both possibilities.

Figure 35.1: Empirical Measure of f_t

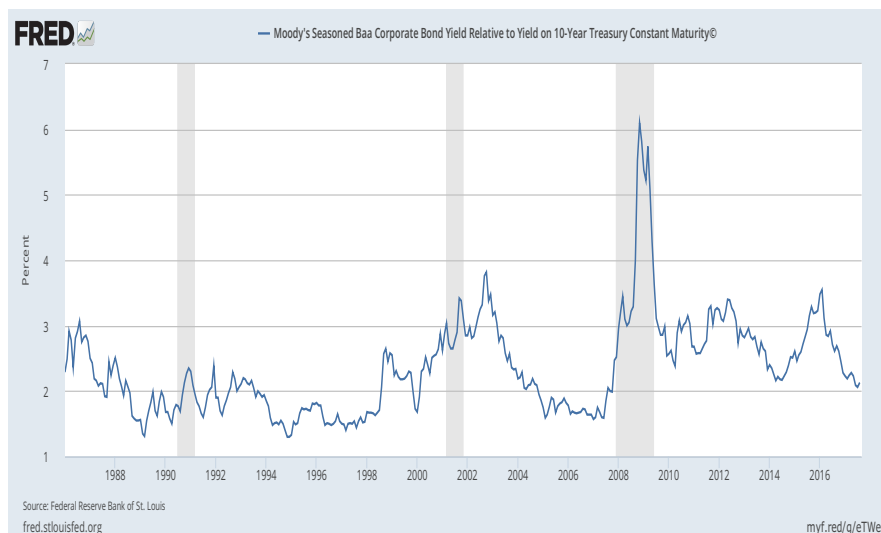

As long as f_t is treated as completely exogenous, its inclusion does not fundamentally alter the graphical depiction of the equilibrium of the model. This is shown below in Figure 35.3 for the partial sticky price model. The inclusion of f_t as an exogenous variable simply motivates an additional reason for the IS and hence AD curves to shift, as we shall see below.

Figure 35.2: Equilibrium in the Partial Sticky Price Model with Financial Frictions

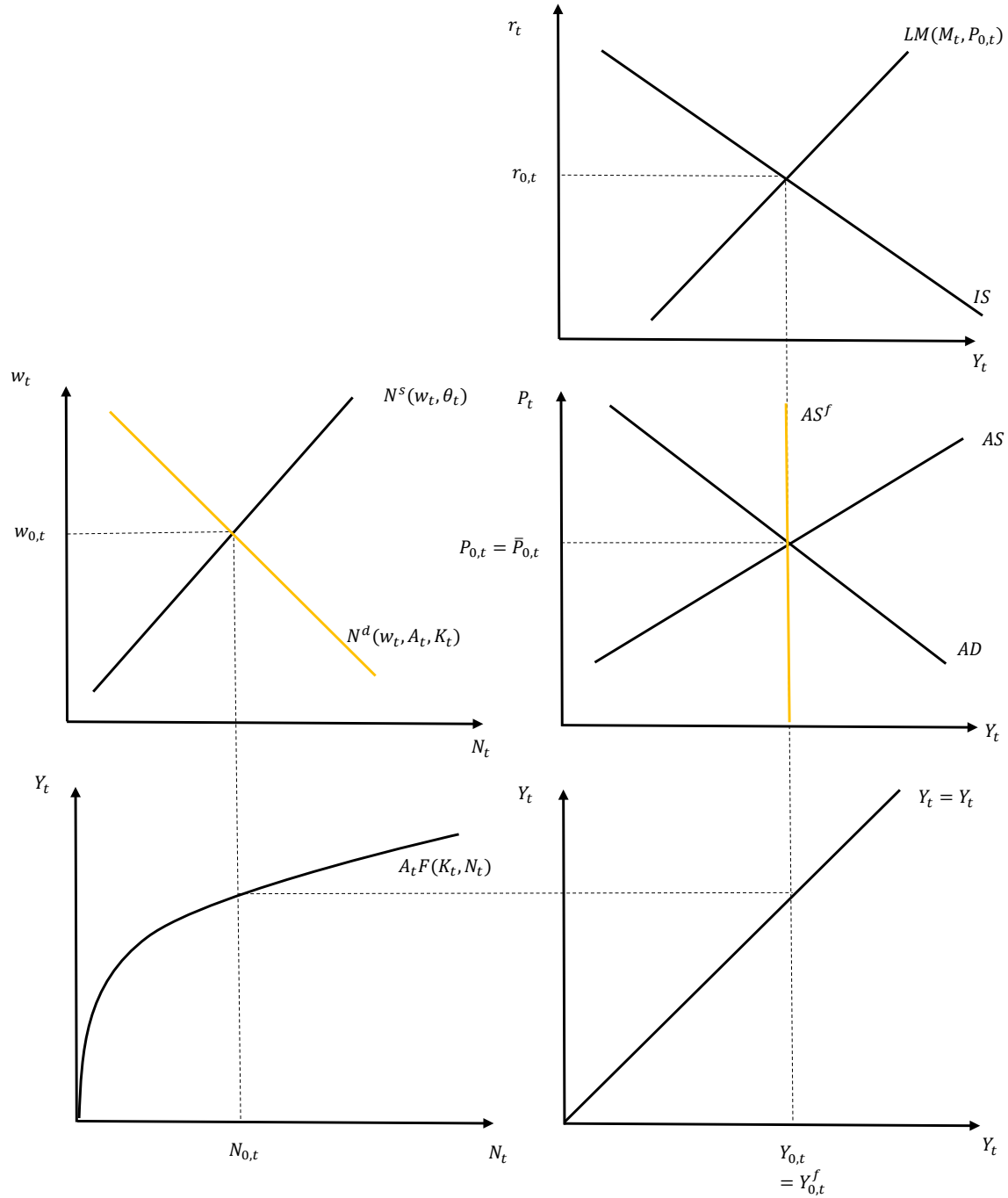

35.2 Detailed Foundations

Although we will think of f_t as exogenous for the reasons enumerated above, we can show how to formally include it in a mathematical derivation of the model's decision rules. This is similar to what is presented in Chapter 12.

The model continues to consist of a representative household, a representative firm, a government, and a financial intermediary (or bank). As in Chapter 12, it plays a fairly passive role, but differently than our earlier presentation, it can earn a profit which is remitted back to the household. In period t , it takes in savings, S_t , from the household, and lends that savings to the firm for investment and to the government for debt issuance. In period $t + 1$, the firm pays back principal plus interest of $r_t + f_t$. The government pays back principal plus interest of r_t . The financial intermediary returns any profit to the household in the form of a dividend. We do not formally model a decision rule for the financial intermediary, instead simply taking f_t as given.

In period t , the financial intermediary earns nothing – it simply takes in deposits, S_t , from the household and lends them to the firm in the amount, B_t^I , and the government in the amount B_t^G . In $t + 1$, it earns revenues of $(r_t + f_t)B_t^I + r_t B_t^G$ and has interest expense of $r_t S_t$. Its profit is:

$$D_{t+1}^I = (r_t + f_t)B_t^I + r_t B_t^G - r_t S_t \quad (35.9)$$

The government chooses an exogenous stream of spending, G_t and G_{t+1} . Spending is financed via a mix of taxes, T_t , and debt, B_t . The government's flow budget constraints are:

$$G_t \leq T_t + B_t^G \quad (35.10)$$

$$G_t + r_t B_t^G \leq T_{t+1} + B_{t+1}^G - B_t^G \quad (35.11)$$

The government borrows from the financial intermediary at the same interest rate the household earns on saving, r_t . In other words, there is no interest spread facing the government.

The household side of the model is identical to what was presented earlier. The household earns income from working, pays lump sum taxes to the government, and also earns dividend income from ownership in the production firm as well as in the financial intermediary. Its flow budget constraints are:

$$C_t + S_t \leq w_t N_t + D_t - T_t \quad (35.12)$$

$$C_{t+1} + S_{t+1} \leq w_{t+1} N_{t+1} - T_{t+1} + D_{t+1} + D_{t+1}^I + (1 + r_t)S_t \quad (35.13)$$

Its objective is to pick a consumption-saving and labor supply plan to maximize:

$$U = u(C_t, 1 - N_t) + \beta u(C_{t+1}, 1 - N_{t+1}) \quad (35.14)$$

Optimization gives rise to standard first order conditions:

$$u_C(C_t, 1 - N_t) = \beta(1 + r_t)u_C(C_{t+1}, 1 - N_{t+1}) \quad (35.15)$$

$$u_L(C_t, 1 - N_t) = w_t u_C(C_t, 1 - N_t) \quad (35.16)$$

$$u_L(C_{t+1}, 1 - N_{t+1}) = w_{t+1} u_C(C_{t+1}, 1 - N_{t+1}) \quad (35.17)$$

Along with the fact that the household only cares about the presented discounted value of government spending, not the timing and sequence of taxes, these can be used to motivate the consumption and labor supply functions presented above, (35.1)-(35.2).

The firm produces output according to the production function $Y_t = A_t F(K_t, N_t)$, where A_t is exogenous and the firm is initially endowed with an exogenous amount of capital, K_t . New capital can be accumulated via investment, $K_{t+1} = I_t + (1 - \delta)K_t$. This investment must be financed via borrowing, B_t^I , at the effective real interest rate $r_t + f_t$. The firm's objective is to maximize its value, where $V_t = D_t + \frac{D_{t+1}}{1+r_t}$. If the price level is flexible, the firm can choose both I_t and N_t . Otherwise, the firm chooses I_t and picks N_t to satisfy demand at its price. For expositional purposes, we write the firm's problem where it can choose both N_t and I_t :

$$\begin{aligned} \max_{N_t, I_t} \quad & V_t = A_t F(K_t, N_t) - w_t N_t + \\ & \frac{1}{1 + r_t} \left[A_{t+1} F(K_{t+1}, N_{t+1}) + (1 - \delta)K_{t+1} - w_{t+1} N_{t+1} - (1 + r_t + f_t) B_t^I \right] \end{aligned} \quad (35.18)$$

In (35.18), the $(1 - \delta)K_{t+1}$ term is the liquidation value of the firm – any remaining leftover capital is returned to the household in the period $t + 1$ dividend. $(1 + r_t + f_t)B_t^I$ is the firm's financing cost which must be paid back in $t + 1$. Since $B_t^I = I_t = K_{t+1} - (1 - \delta)K_t$, we can re-cast the firm's problem as one of choosing K_{t+1} instead of I_t :

$$\begin{aligned} \max_{N_t, K_{t+1}} \quad & V_t = A_t F(K_t, N_t) - w_t N_t + \\ & \frac{1}{1 + r_t} \left[A_{t+1} F(K_{t+1}, N_{t+1}) + (1 - \delta)K_{t+1} - w_{t+1} N_{t+1} - (1 + r_t + f_t)(K_{t+1} - (1 - \delta)K_t) \right] \end{aligned} \quad (35.19)$$

The first order conditions are:

$$\frac{\partial V_t}{\partial N_t} = 0 \Leftrightarrow A_t F_N(K_t, N_t) = w_t \quad (35.20)$$

$$\frac{\partial V_t}{\partial K_{t+1}} = 0 \Leftrightarrow r_t + f_t + \delta = A_{t+1} F_K(K_{t+1}, N_{t+1}) \quad (35.21)$$

(35.20) is identical to what we encountered earlier, and (35.21) is the same with the addition of f_t on the left hand side. (35.21) implicitly defines an optimal K_{t+1} as a function of $r_t + f_t$, where the optimal K_{t+1} is decreasing in $r_t + f_t$. This means that investment is decreasing in $r_t + f_t$, which motivates the decision rule presented above, (35.4).

Market-clearing requires that $S_t = I_t + B_t^G$ – i.e. household saving equal firm investment plus government borrowing, $D_t = Y_t - w_t N_t$, and $B_t^G = G_t - T_t$. Combing these together with (35.12) yields the standard resource constraint of $Y_t = C_t + I_t + G_t$. In period $t + 1$ no actors die with positive or negative stocks of assets, so $S_{t+1} = B_{t+1}^G = 0$. Investment is the liquidation value of any remaining capital, $I_{t+1} = (1 - \delta)K_{t+1}$. (35.13) then implies $Y_{t+1} = C_{t+1} + I_{t+1} + G_{t+1}$.

Referencing back to our work in Chapter 15, note that even in the absence of price stickiness (i.e. $\gamma \rightarrow \infty$), the equilibrium allocations will in general *not* coincide with what a benevolent social planner would choose *unless* $f_t = 0$. To see this, note that one of the first order conditions for a hypothetical planner's problem (see Chapter 15 for details) would be:

$$u_C(C_t, 1 - N_t) = \beta u_C(C_{t+1}, 1 - N_{t+1})(A_{t+1} F_K(K_{t+1}, N_{t+1} + (1 - \delta))) \quad (35.22)$$

Combining (35.21) with (35.15), we would obtain:

$$u_C(C_t, 1 - N_t) = \beta u_C(C_{t+1}, 1 - N_{t+1})(A_{t+1} F_K(K_{t+1}, N_{t+1} + (1 - \delta) - f_t)) \quad (35.23)$$

(35.22) and (35.23) are only the same in the event that $f_t = 0$. If $f_t > 0$, then the equilibrium allocation will in general feature consumption that is too high, and investment that is too low, relative to what the planner would prefer.¹ Given our assumptions on labor supply, however, the equilibrium level of output will coincide with the efficient level. For the purposes of thinking about optimal monetary policy when prices are sticky, we will *ignore* the fact that $f_t \neq 0$ means that the neoclassical equilibrium is not efficient. Formally, we can motivate this assumption by thinking that the *average* level of f_t is small (which it is in the data, see Figure 35.3), and hence we can safely ignore the effect of $f_t \neq 0$ on thinking about the efficient level of output.

¹To see this, note that the bigger f_t is, the smaller $u_C(C_t, 1 - N_t)$ must be for (35.23) to hold, so C_t will be bigger.

35.3 Equilibrium Effects of an Increase in the Credit Spread

We are now in a position to analyze the economic effects of a change in the exogenous credit spread variable, f_t . Suppose that this increases. The effects of this are shown in Figure 35.3. This has the effect of shifting the IS curve in to the left – for a given r_t , the cost of investment is higher, and hence there will be a reduction in investment. This results in the AD curve shifting in to the left. To the extent to which the AS curve is non-horizontal, the price level falls. The fall in the price level causes the LM curve to shift out to the right somewhat. In equilibrium, r_t is lower and Y_t is lower. Lower Y_t must be met by lower N_t given no change in A_t or K_t . This necessitates a reduction in the real wage.

Figure 35.3: Increase in Credit Spread

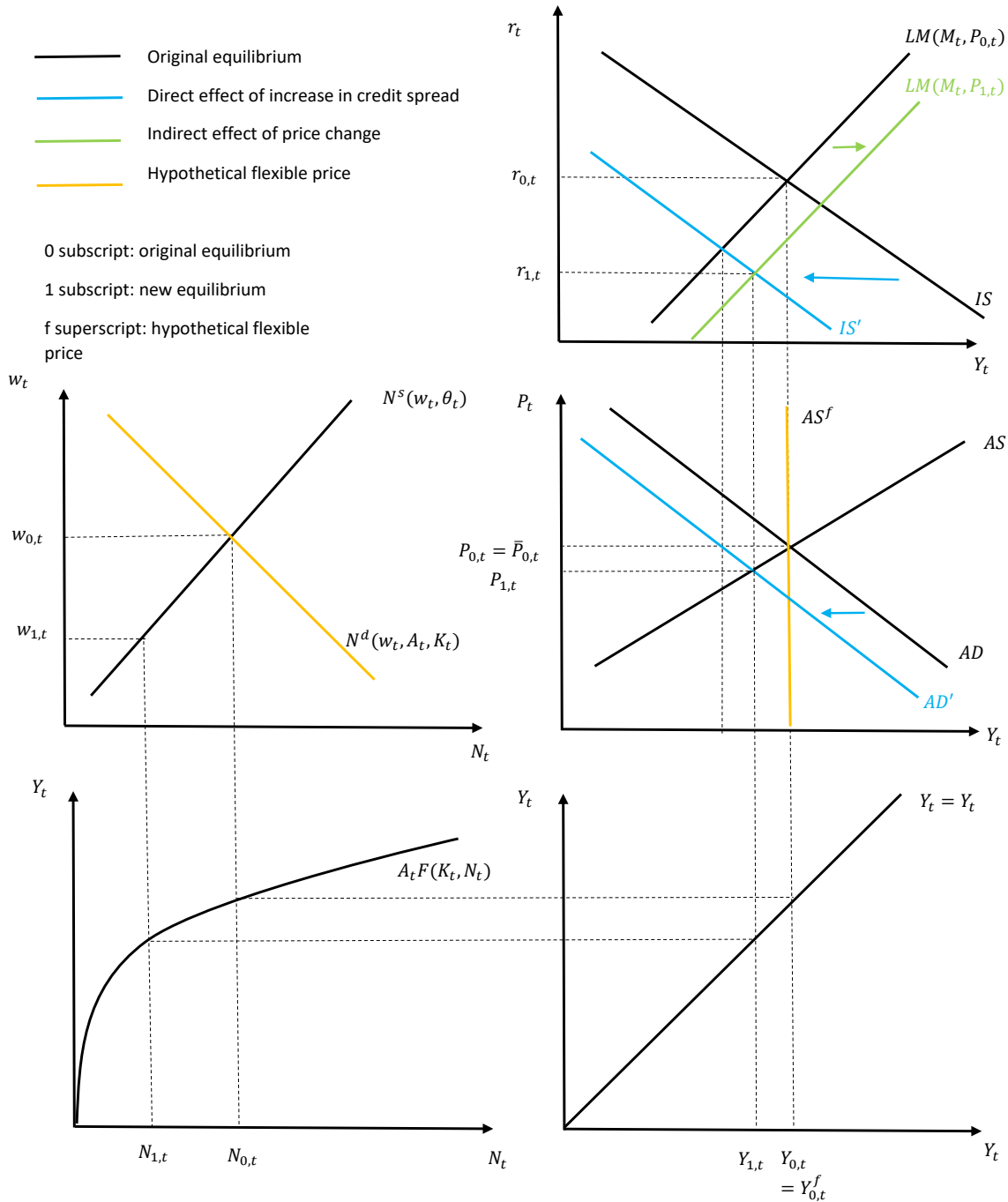

What happens to consumption and investment in equilibrium? For investment, on the one hand r_t is lower but on the other hand f_t is higher. We can nevertheless conclude that I_t must be lower in equilibrium. Suppose that $\gamma \rightarrow \infty$, so that the AS curve is vertical. In this case, r_t would fall, but Y_t would be unchanged. r_t being lower with Y_t unaffected would mean C_t is higher, but higher C_t with no change in Y_t necessitates a lower I_t . Hence, even if

prices were flexible, I_t would fall in equilibrium. For the more general case in which prices are sticky (either partially or completely), r_t will fall by *less* than it would in the flexible price case. Hence, we can conclude that I_t must fall whenever f_t increases. It is not possible to definitively sign the effect of an increase in f_t on C_t . On the one hand, r_t is lower, which would work to raise C_t . On the other hand, Y_t is also lower, which would work to lower C_t . Which effect dominates is unclear. In the case where prices are flexible (see immediately above), Y_t is unaffected so we can be sure that C_t rises when f_t increases. When prices are sticky and Y_t falls, however, we cannot be sure. It is plausible that C_t is far more sensitive to Y_t than to r_t , so it seems a safe bet that if prices are at all sticky C_t would decline when f_t increases.

Large increases in credit spreads seem to be a recurrent feature of financial crises, as we discuss further in Chapter 36. In particular, we can think about financial crises as “runs” in which there is a flight from perceived risky debt (i.e. loans to the firm in the context of this model) into safer forms of debt (reserves for banks, checking accounts or currency for households). This flight to safety triggers an increase in the credit spread, which leads to a reduction in investment and economic activity more generally, as is shown in Figure 35.3.

35.4 The Financial Accelerator

Figure 35.1 shows that credit spreads (differences in yields between risky and riskless debt of the same maturity) are quite countercyclical. Immediately above we considered exogenous increases in credit spreads as a source of fluctuations, and argued that large increases in spreads, such as that observed during the Great Recession, are likely to emerge during periods of financial crisis.

There are, however, smaller fluctuations in credit spreads that also appear countercyclical. For example, in Figure 35.1 credit spreads rose near the end of both the 1990 and 2001 recessions, albeit not be nearly as much as spreads rose during the Great Recession. It seems reasonable to think that there may be an *endogenous* component to credit spreads that accounts for these smaller cyclical patterns. This is reasonable because it seems likely that firm default risk is highest when the economy is weakest; to compensate for heightened default risk, financial intermediaries require a higher spread to lend to production firms. This endogenous component to credit spreads can *amplify* cyclical fluctuations. It is called the “financial accelerator” in, for example, [Bernanke, Gertler, and Gilchrist \(1999\)](#). A worsening economy (lower Y_t) results in higher credit spreads (higher f_t), which further worsens the economy.

Formally, suppose that the credit spread variable has both an endogenous and an exogenous

component as follows:

$$f_t = \bar{f}_t - aY_t \quad (35.24)$$

In (35.24), \bar{f}_t is the exogenous component of the credit spread variable. Changes in it have effects like those summarized in Figure 35.3. $-aY_t$ is the endogenous component, with $a \geq 0$. The parameter a measures the strength of the financial accelerator mechanism. The bigger it is, the more sensitive the credit spread variable is to overall economic conditions.

We can think about the full description of the model (showing the partial sticky price version, which is the most general version) as the same as (35.1)-(35.8) above, with an additional endogenous variable, f_t , and an additional equation, (35.24).

The inclusion of a financial accelerator mechanism will have two effects on the model. The first will be to make the IS and hence the AD curve both flatter. The second will be that the IS and hence the AD curves will shift *more* in response to exogenous shocks than they would without the financial accelerator. To see this formally, begin by defining total desired expenditure, Y_t^d , as the sum of the consumption function, (35.1); the investment demand function, (35.4); and government spending:

$$Y_t^d = C^d(Y_t - G_t, Y_{t+1} - G_{t+1}, r_t) + I^d(r_t + \bar{f}_t - aY_t, A_{t+1}, K_t) + G_t \quad (35.25)$$

Autonomous expenditure is (35.25) evaluated when $Y_t = 0$:

$$E_0 = C^d(-G_t, Y_{t+1} - G_{t+1}, r_t) + I^d(r_t + \bar{f}_t, A_{t+1}, K_t) + G_t \quad (35.26)$$

We once again assume that autonomous expenditure is positive, $E_0 > 0$. Total desired expenditure is a function of total income. Differentiating (35.25) with respect to Y_t , we get:

$$\frac{\partial Y_t^d}{\partial Y_t} = \frac{\partial C^d(\cdot)}{\partial Y_t} - a \frac{\partial I^d(\cdot)}{\partial r_t} \quad (35.27)$$

In (35.27), $\frac{\partial C^d(\cdot)}{\partial Y_t}$ is the derivative of the consumption function with respect to its first argument (net income), while $\frac{\partial I^d(\cdot)}{\partial r_t}$ is the derivative of the investment demand function with respect to its first argument (the interest rate relevant for the firm, so $r_t + f_t = r_t + \bar{f}_t - aY_t$). The $-a$ term shows up multiplying this derivative because $-a$ is the derivative of $r_t + \bar{f}_t - aY_t$ with respect to Y_t . If we once again call the partial of the consumption function with respect to current net income the MPC and treat it as a constant, we have:

$$\frac{\partial Y_t^d}{\partial Y_t} = MPC - a \frac{\partial I^d(\cdot)}{\partial r_t} \quad (35.28)$$

Note that since $\frac{\partial I^d(\cdot)}{\partial r_t} < 0$, the derivative of desired expenditure with respect to current income in (35.28) is *bigger* than if $a = 0$ (i.e. no financial accelerator mechanism). We can graphically see how this impacts the derivation of the *IS* curve using the “Keynesian Cross” diagram shown below in Figure 35.4. To make things as clear as possible, we draw in two expenditure lines which cross the 45 degree at the same level of Y_t for an initial interest rate of $r_{0,t}$. The one without a financial accelerator is shown in black, whereas the one with the accelerator is steeper and shown in red. We then consider a reduction in the real interest rate from $r_{0,t}$ to $r_{1,t}$. This causes both expenditure lines to shift up in an equal amount (assuming the same interest sensitivity of investment demand), shown in blue and orange, respectively. When the expenditure line is steeper, the resulting change in Y_t for a given r_t is *bigger*. Hence, the presence of a financial accelerator mechanism makes the *IS* curve *flatter*.

Figure 35.4: The IS Curve with the Financial Accelerator

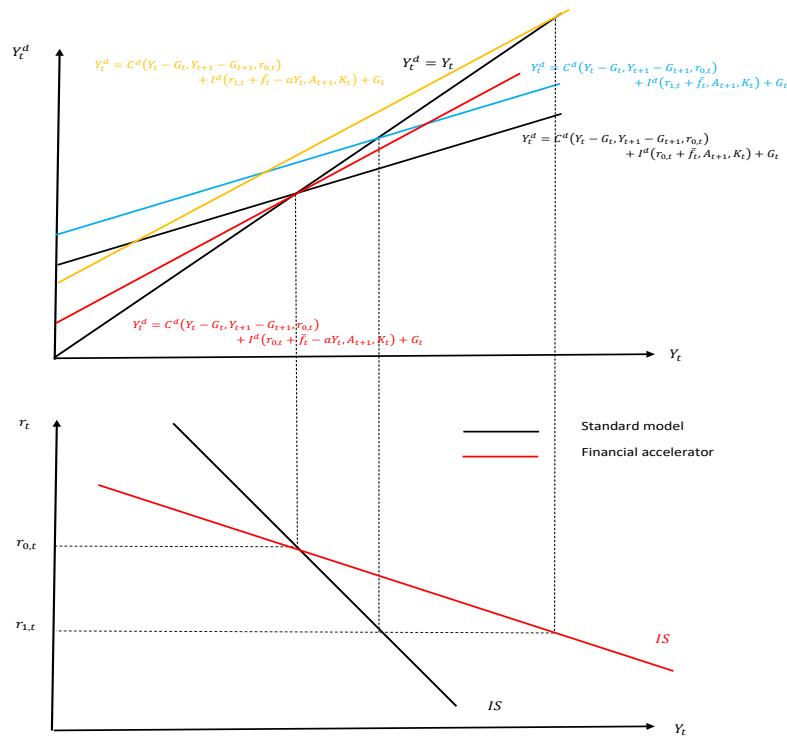

We can also see this algebraically. The *IS* curve is implicitly defined by taking (35.25) and equating $Y_t = Y_t^d$:

$$Y_t = C^d(Y_t - G_t, Y_{t+1} - G_{t+1}, r_t) + I^d(r_t + \bar{f}_t - aY_t, A_{t+1}, K_t) + G_t \quad (35.29)$$

Total differentiate (35.29) about a point:

$$dY_t = \frac{\partial C^d(\cdot)}{\partial Y_t}(dY_t - dG_t) + \frac{\partial C^d(\cdot)}{\partial Y_{t+1}}(dY_{t+1} - dG_{t+1}) + \frac{\partial C^d(\cdot)}{\partial r_t}dr_t + \frac{\partial I^d}{\partial r_t}(dr_t + d\bar{f}_t - adY_t) + \frac{\partial I^d}{\partial A_{t+1}}dA_{t+1} + \frac{\partial I^d}{\partial K_t}dK_t + dG_t \quad (35.30)$$

Treating all exogenous variables as fixed, (35.30) reduces to:

$$dY_t = \frac{\partial C^d(\cdot)}{\partial Y_t}dY_t + \frac{\partial C^d(\cdot)}{\partial r_t}dr_t + \frac{\partial I^d}{\partial r_t}(dr_t - adY_t) \quad (35.31)$$

Solving for dY_t/dr_t , we obtain:

$$\frac{dY_t}{dr_t} = \frac{\frac{\partial C^d(\cdot)}{\partial r_t} + \frac{\partial I^d(\cdot)}{\partial r_t}}{1 - \frac{\partial C^d(\cdot)}{\partial Y_t} + a \frac{\partial I^d(\cdot)}{\partial r_t}} \quad (35.32)$$

Since both partial derivatives in the numerator are negative, the overall slope is negative – i.e. the *IS* curve is downward-sloping. Since $\frac{\partial I^d(\cdot)}{\partial r_t} < 0$, if $a > 0$ then the denominator is *smaller* the bigger is a , so the overall slope is *more* negative, and, in a graph with Y_t on the horizontal axis, consequently flatter.²

A flatter *IS* curve results in a flatter *AD* curve as well. We can see this graphically in Figure 35.5 below. A given shift of the *LM* curve due to a change in the price level results in a larger change in Y_t (and a smaller change in r_t) the flatter is the *IS* curve.

²Note that we are making an additional assumption. This is that $a \frac{\partial I^d(\cdot)}{\partial r_t}$ is not so negative to make the denominator in (35.32) negative, which would make the *IS* curve upward-sloping.

Figure 35.5: The AD Curve with the Financial Accelerator

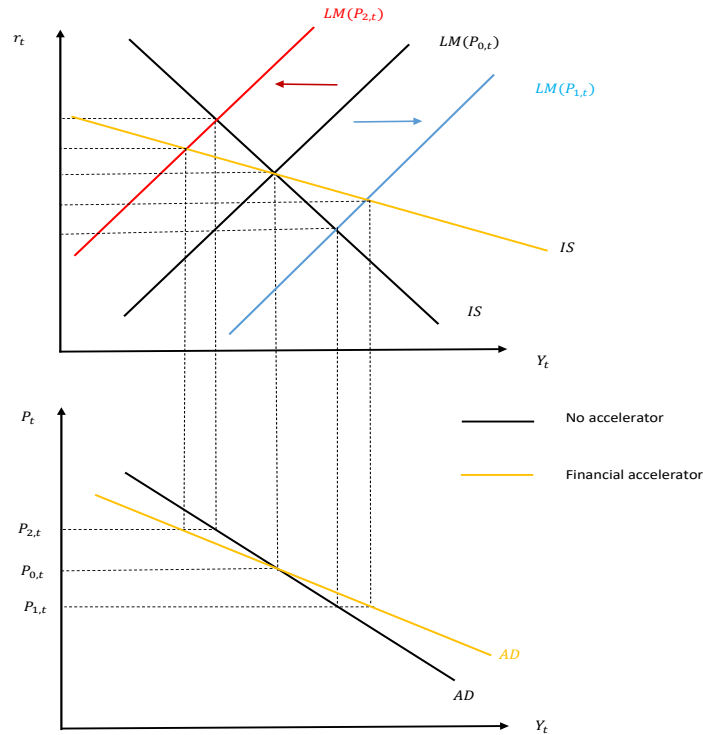

Not only does the presence of a financial accelerator mechanism affect the shape of the IS and AD curves, it also impacts how they shift in response to an exogenous shock. We can see this graphically in Figure 35.6. This figure considers an exogenous increase in G_t which shifts the expenditure line up by a given amount regardless of whether there is a financial accelerator mechanism or not. Holding the real interest rate fixed, a given upward-shift in the expenditure line results in a *larger* horizontal shift to the right in the IS curve (and hence also in the AD curve). We draw the figure where we think of this shift as resulting from an increase in G_t , but qualitatively we would get the same picture if we considered a reduction in G_{t+1} , an increase in A_{t+1} , or a reduction in \bar{f}_t .

Figure 35.6: Shift of the IS Curve with the Financial Accelerator

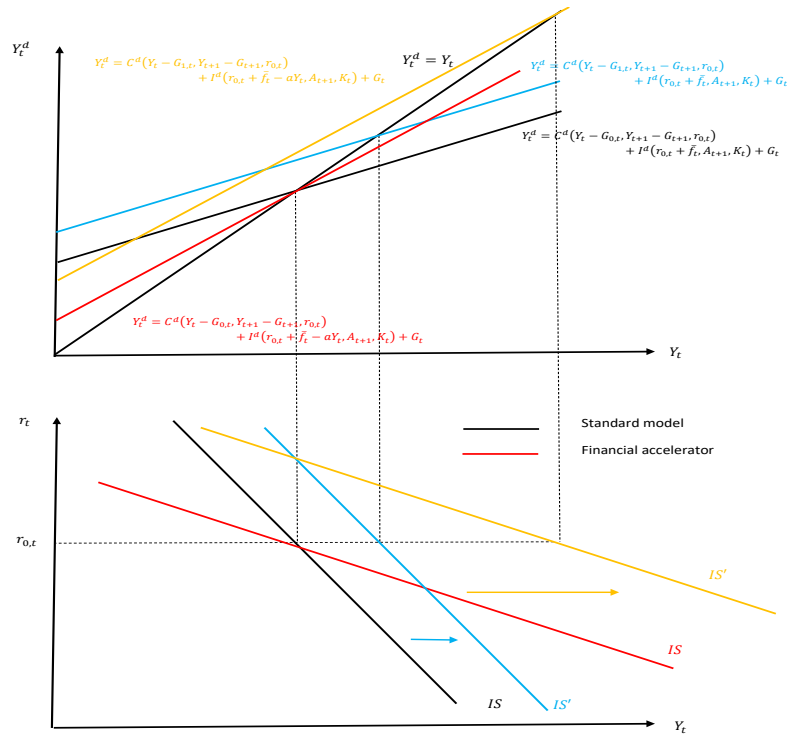

We can use the familiar IS-LM-AD-AS curves to summarize the equilibrium of the model. This is done so in Figure 35.7. We show two IS curves and two AD curves, one corresponding to the case of the financial accelerator mechanism being present (i.e. $a > 0$, shown in orange), the other not (shown in black). We draw in the curves where the equilibrium levels of output, the price level, and the real interest rate are nevertheless the same initially. We consider the partial sticky price model, with the neoclassical model (vertical AS curve) and simple sticky price model (horizontal AS curve) being special cases.

Figure 35.7: IS-LM-AD-AS Curves with Financial Accelerator

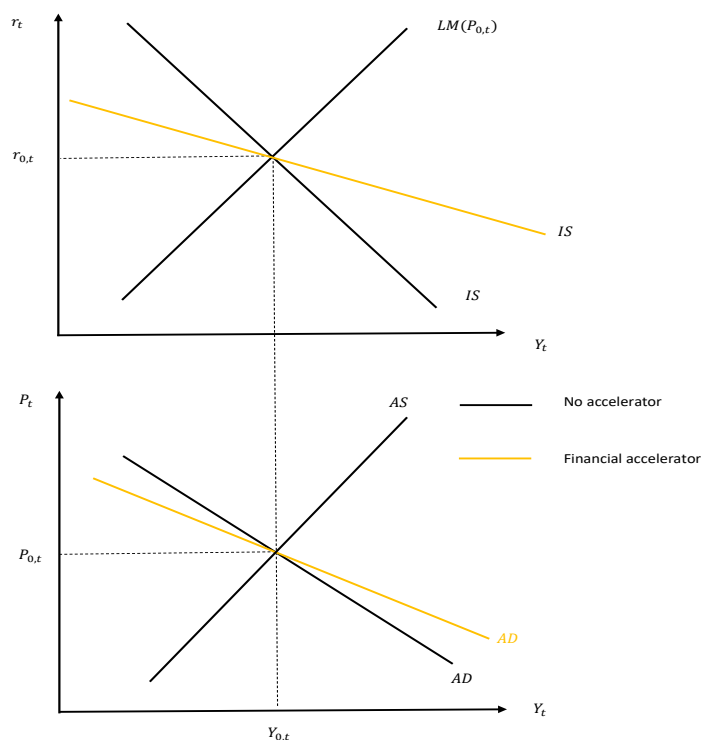

We are now in a position to analyze how the financial accelerator impacts the effects of shocks. Consider first a positive supply shock (e.g. an increase in A_t or a reduction in θ_t). This causes the AS curve to shift right. The flatter is the AD curve, the more output reacts (and the less the price level and the real interest rate react). This can be seen below. We can conclude that the financial accelerator *amplifies* the output effects of supply shocks.

Figure 35.8: Supply Shock with Financial Accelerator

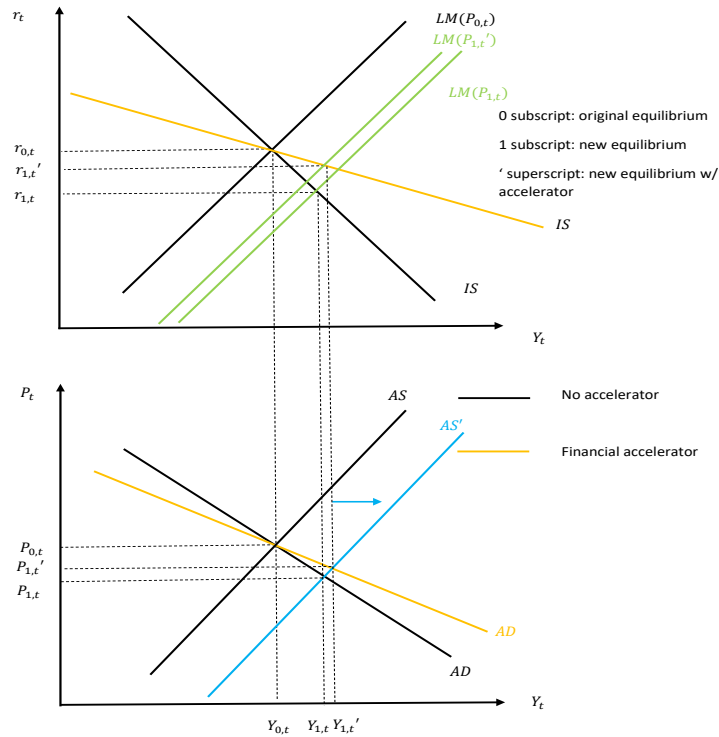

What about demand shocks? Consider a shock which causes the IS curve to shift to the right (e.g. an increase in G_t). To make the graph a bit more readable, consider the simple sticky price model, so that the AS curve is perfectly horizontal and we need not worry about secondary effects on the position of the LM curve arising due to price level changes. As noted above, the presence of a financial accelerator mechanism results in the IS and AD curves shifting horizontally by *more* whenever there is an exogenous shock to the IS curve. This results in *bigger* movements in equilibrium output compared to a situation in which there is no financial accelerator mechanism.

Figure 35.9: Demand Shock with Financial Accelerator, Simple Sticky Price Model

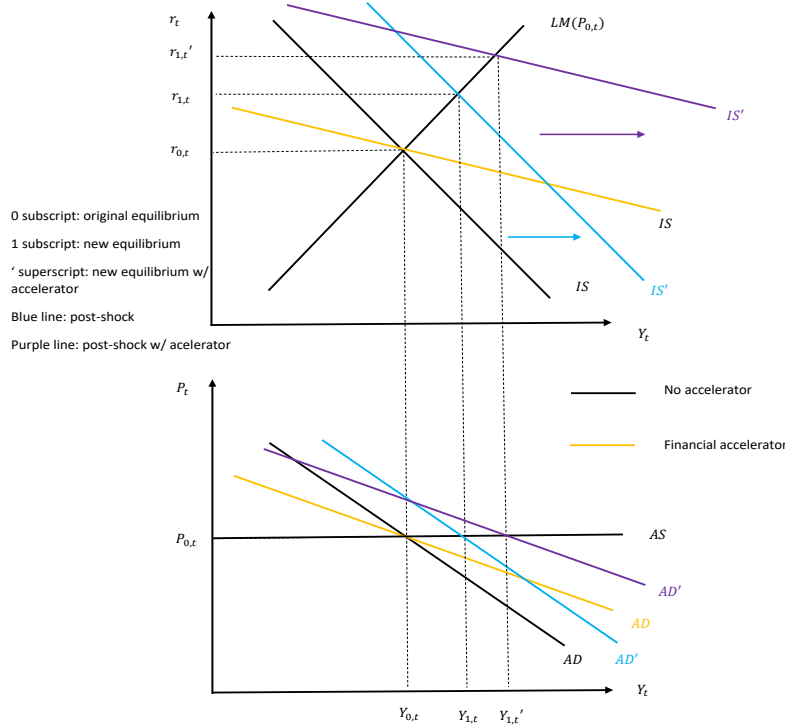

In summary, then, the financial accelerator mechanism amplifies the output responses to *both* demand and supply shocks. In addition to helping account for the countercyclical behavior of empirical measures of credit spreads in the data, it can also help generate more output volatility in general, which is something quantitative models generally have difficulty in doing.

35.5 Summary

- For financial intermediation to be valuable there must be some friction or market incompleteness. Otherwise a firm's financial structure is irrelevant.
- We add financial frictions in the model by assuming that the rate firms borrow at exceeds the rate at which households save. This is a credit spread and, while exogenous, can be motivated by some sort of risk or term premium.
- If the credit spread is positive, the equilibrium allocations will not be Pareto efficient. This is true even if prices are completely flexible.
- An increase in the credit spread shifts the IS curve to the left so output falls in equilibrium. Given that empirical measures of the credit spread seem to rise during

recessions (and, in particular, financial crises), fluctuations in the credit spread are likely contributors to recessions.

- Default is most likely when the economy is the weakest. Creditors realize this and charge higher interest rates. Those high interest rates in turn make default more likely and extends a recession. This is the basic idea of the financial accelerator.
- The inclusion of the financial accelerator flattens the IS and AD curves and amplifies both supply and demand shocks.

Key Terms

1. Credit spread
2. Financial accelerator

Questions for Review

1. Explain the financial accelerator mechanism.
2. Will an increase in f_t have a bigger effect on output when γ is big or small?
3. Would you expect an increase in f_t to have bigger effects at or away from the ZLB?

Exercises

1. Suppose there is an increase in f_t .
 - (a) Graphically depict this change in f_t .
 - (b) What is optimal monetary policy in this case? Show this graphically. How do all the endogenous variables change relative to Part 1a?
 - (c) Suppose there is no change in monetary policy. How can the government change G_t to achieve the same level of output as in Part 1b? adjust such that there is no change in output? Graphically depict this. How do all of the other endogenous variables change?
 - (d) Does the fiscal policy in Part 1c implement the Pareto optimal allocations? Explain.

Chapter 36

Financial Crises and The Great Recession

Financial crises and the ensuing economic recessions associated with them are a recurrent theme in modern, developed economies. In the last century, there have been two major financial crises followed by deep recessions in the United States – the Great Depression from 1929-1933 and the Great Recession from 2007-2009. Many economists thought that such crises were a thing of the past prior to the Great Recession. The Great Recession proved these economists wrong. In this chapter, we briefly outline the typical structure of financial crises and stress the fundamental similarity between the Great Recession and the earlier Great Depression. We use the short run New Keynesian model as a laboratory to think about the Great Recession as well as the myriad non-standard policy interventions in its wake. The material in this chapter builds off of Chapters 25-28 and Chapters 30, 32, and 35, although much of it should be self-contained.

Many books have and will be written about financial crises more generally and about the recent Great Recession in particular. Our objective is not to provide a full, detailed account of the Great Recession, nor is it to develop a full-fledged critique of modern macroeconomics in light of the recession. Rather, we wish to give a brief overview of financial crises more generally, a brief overview of the facts surrounding the Great Recession, and then we want to use the tools and models developed elsewhere in this book to think about the events surrounding the recession as well as the unconventional policy interventions in its wake.

For the interested reader, a good book-length treatment of financial crises with a focus on the Great Recession is found in [Gorton \(2012\)](#). Much of the material in this chapter follows this book. Some of the material is also closely related to [Mishkin \(2016\)](#).

36.1 Financial Crises: The Great Depression and Great Recession

Financial crises occur with some regularity in market economies. Financial crises were common in the US throughout the 19th and early part of the 20th century, prior to the founding of the Federal Reserve and the centralization of the monetary and banking systems. The US has experienced two major financial crises, both followed by deep recessions, in the last one hundred years. The Great Depression lasted from 1929-1933, with another milder

recession later in the 1930s. The US economy did not fully recover from this event until after World War II. The Great Recession happened in the US from 2007-2009. While economic growth resumed in the US in the latter half of 2009, the economy's performance, unlike many other recent US recessions, was not so robust as to make up for the losses during the recession. Both the Great Depression and Great Recession were global in nature.

Financial crises are associated with major disruptions between the flow of funds from savers to borrowers. The tell-tale sign of a financial crisis is an increase in credit spreads (i.e. the difference between the interest rates faced by firms for long term, illiquid projects and the interest rates on short term, liquid savings instruments like checking accounts and government bonds). In Chapter 35 we formally show how to incorporate an exogenous credit spread into an otherwise conventional macro model. An increase in credit spreads leads to a sharp reduction in demand and a potentially deep recession. The deep recession is often made deeper by monetary policy being hampered by the zero lower bound on interest rates. Further, as documented in Chapter 28, the economy's inability to correct itself to the medium run neoclassical equilibrium can be hampered by the ZLB, which makes the output contraction both deeper and more prolonged than it otherwise might be.

In the paragraph above we focus on the *macroeconomic* nature of recessions due to financial crises – increases in credit spreads lead to a contraction in aggregate demand which can be exacerbated by the ZLB. But what causes the increase in credit spreads? Typically, financial crises are preceded by asset price booms and busts. Although popular in the financial press, we hesitate to associate the term “bubble” with such boom and bust episodes, because what a “bubble” is in from an economists' perspective is slightly different than what the financial press typically means, which is a period of excessive asset price appreciation followed by a large asset price decline. See the discussion on bubbles in Chapter 34.

Figure 36.1 plots the real S&P 500 stock market index in the years leading up to and immediately after the Great Depression. The data for this and Figure 36.2 can be obtained from Robert Shiller's [website](#). The asset price boom and bust associated with the Great Depression involved the general stock market. In the three years leading up to the onset of the Great Depression, the S&P 500 index more than doubled. This is more than a 25 percent average appreciation per year, which is astounding given that the typical price appreciation over more than one hundred years of data is about 7 percent. Things came crashing down abruptly on “Black Tuesday,” October 29, 1929. There was a massive selloff which can be seen in Figure 36.1, leading to depressed share prices. The decline in share prices continued for several more years. At the trough in 1932, the market as a whole was valued at less than 25 percent of its peak value in the fall of 1929.

Figure 36.1: S&P 500 Stock Market Index Around Great Depression

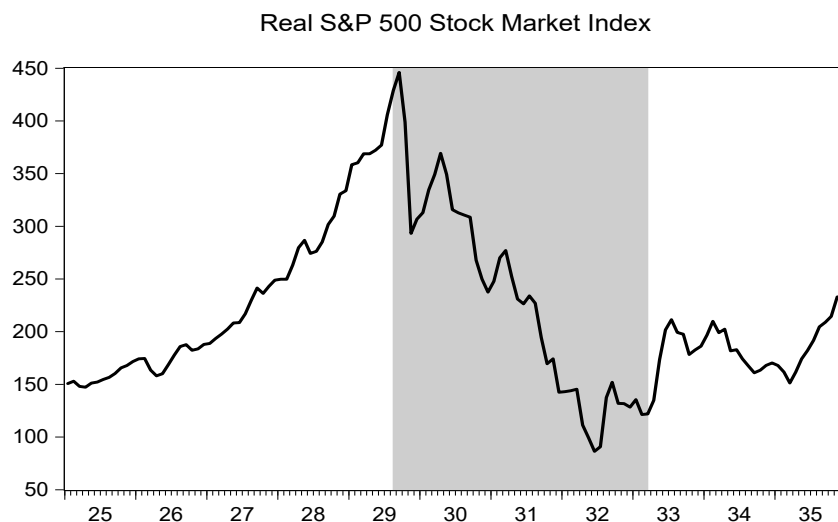

The asset price boom and bust preceding the Great Recession was not the general stock market but rather the housing market. Figure 36.2 plots the behavior of a nationwide price index for houses in the United States in the years surrounding the Great Recession. In the years between roughly 2000 and the end of 2006, home prices in the US more than doubled. Home prices nationwide began to flatline in 2006 and started to decline at the end of 2006 and through 2007, well before the economic contraction began. Home prices continued to decline long after the recession was officially over.

Figure 36.2: Real Home Price Index Around Great Recession

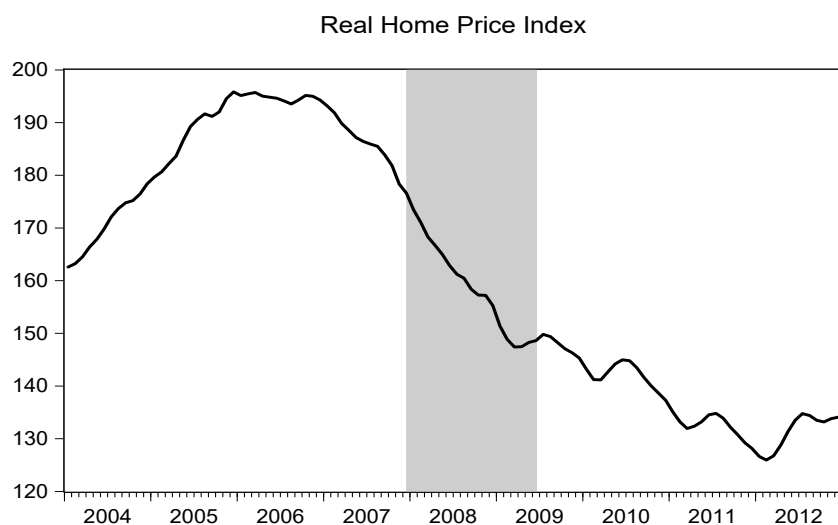

Our objective is not to completely understand *why* asset prices boomed and then busted in these two historical events, but it is useful to briefly mention the leading explanations. During

the 1920s Federal Reserve credit was easy (i.e. interest rates were low), general euphoria about the stock market was high, and lending practices (e.g. buying stocks on margin, i.e. buying stocks with borrowed funds) were not well-regulated. During the 2000s, a variety of factors combined to depress interest rates (making the financing of homes cheaper) and lending standards declined (i.e. mortgages were extended to borrowers who were previously thought to not be credit-worthy). Like the 1920s, a general sense of euphoria also set in where people believed that real estate was a path to sure riches. These factors combined to push up the demand for housing, and with supply limited house prices rose substantially throughout the country.

Significant declines in asset prices can affect the economy through two primary channels. The first is a wealth effect channel. To the extent to which households own assets (e.g. stocks or houses), then declines in the values of these assets can reduce the present discounted value of lifetime income and reduce the demand for consumption. This effect is undoubtedly present in the data (perhaps most especially for homes, where individuals can use equity accumulated in one's home as collateral for loans to finance expenditure), although probably not particularly strong. The potentially bigger problem is that declines in asset prices can trigger banking panics and full-fledged financial crises.

As discussed in Chapters 30 and 32, banks (or more generally bank-like institutions who engage in credit intermediation) fund longer term, illiquid investment projects with shorter term, liquid debt. For the Great Depression, the shorter term, liquid debt was made up mostly of demand deposits. When asset prices declined, individual depositors became concerned about the potential solvency of their banks. This led them to rush, en masse, on their banks, demanding cash in exchange for their deposits. The banking system as a whole never has sufficient cash to meet withdrawal demands en masse, nor should it, in a sense, as we discuss in Chapter 32. The bank runs that plagued the economy in the Great Depression are memorialized in the bank run scene from the famous holiday movie *It's a Wonderful Life*. To come up with cash, banks were forced to sell other assets. This led to kind of a spiraling effect where depressed asset prices raised concerns about bank solvency, which forced more sales of assets in what is sometimes called a "fire sale," which further depressed asset prices. The end result is that banks and other institutions intermediating credit were forced into a situation of *not* making loans but instead trying to sell loans and other related assets. This led to a sharp reduction in available credit and a large increase in the interest rate spreads over safer US government debt.

Figure 36.3: Interest Rate Spread Around Great Depression

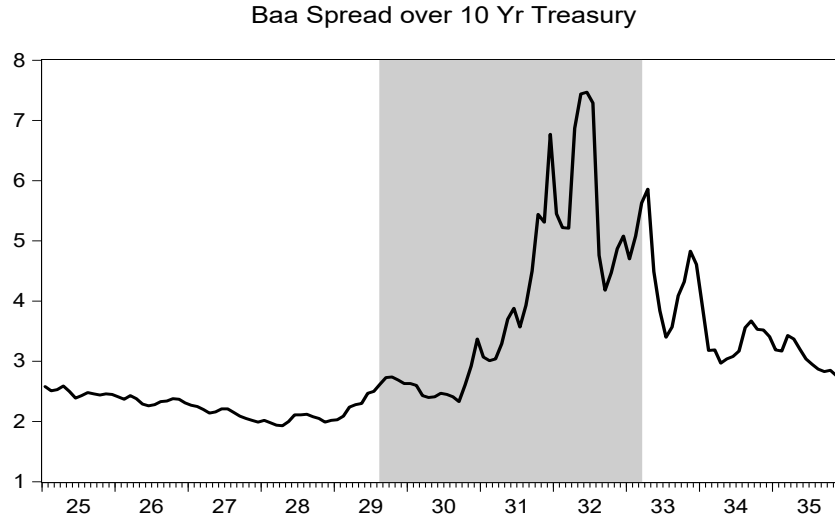
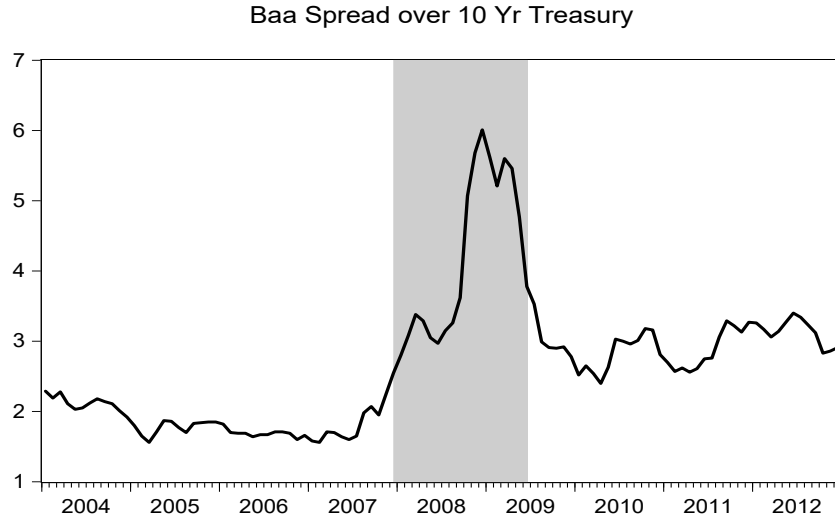

Figure 36.3 plots the monthly time series of the average yield on Baa rated corporate debt relative to the yield on the ten year US Treasury Notes. This is an empirical measure of the interest rate spread series, f_t , which we consider in the model to follow. As we can see in the figure, credit spreads rose from just above 2 percent prior to the Depression to more than 7 percent at its height. It is of interest to note that the observed increase in credit spreads did not occur until some two years after the onset of the Depression. This period coincided with the greatest wave of bank failures. The first major bank runs did not begin until the fall of 1930, which is when we observe credit spreads first increasing. The most vicious period of bank runs occurred between the second half of 1932 and into the first part of 1933, which coincides with the period in which credit spreads were the highest.

During the Great Recession, the decline in home prices led to a more broad-based financial panic. We provide more detail in Section 36.2. Because of concerns about housing related mortgage backed securities, which many financial institutions were heavily exposed to, interbank lending markets dried up. There was, in a sense, a classic banking panic, but it wasn't a run of depositors on commercial banks. Rather, during the Great Recession there was a run of institutions on other institutions. Short term funding dried up. Struggling to come up with liquidity, financial institutions were forced to sell assets unrelated to the housing market. The prices of all financial assets declined and interest rate spreads increased massively. The increase in interest rate spreads is documented in Figure 36.4, which is similar to Figure 36.3, but for the more recent period. The Baa-10 Yr Treasury spread went from less than 2 percent to more than 3 percent throughout 2007. It then skyrocketed to roughly 6 percent in the fall of 2008, when Lehman Brothers, a famous investment bank, failed.

Figure 36.4: Interest Rate Spread Around Great Recession



High credit spreads reduce aggregate demand. In terms of our model, which we will provide more detail on below, the increase in f_t shifts the IS curve in to the left and results in the AD curve shifting in as well. In the short run output should fall, and may fall by more than it otherwise would if the ZLB binds. During both the Great Depression and Great Recession, economic activity contracted significantly. In Figures 36.5 and 36.6, we plot the behavior of the Industrial Production Index in windows around both events. The IP index is available monthly and goes back further in time than does the GDP series we typically focus on, so it is good to use when studying the Depression. For point of comparison, we also plot the IP series during the Great Recession. In both episodes IP falls precipitously. It is worth nothing that the scales are different in the two figures – the IP index is normalized to be 100 in 2012. Hence, the decline from roughly 104 to about 86 during the Great Recession represents a little more than a 15 percent decline in IP (which is similar to measures of GDP relative to a trend). During the Great Depression, the decline in the IP index from roughly 8 to 4 represents a 50 percent decline in economic activity.

Figure 36.5: Industrial Production Index Around Great Depression

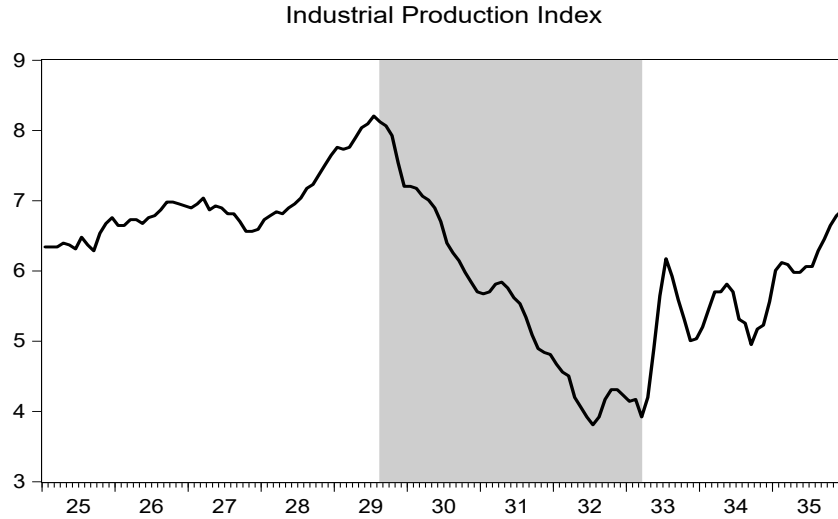
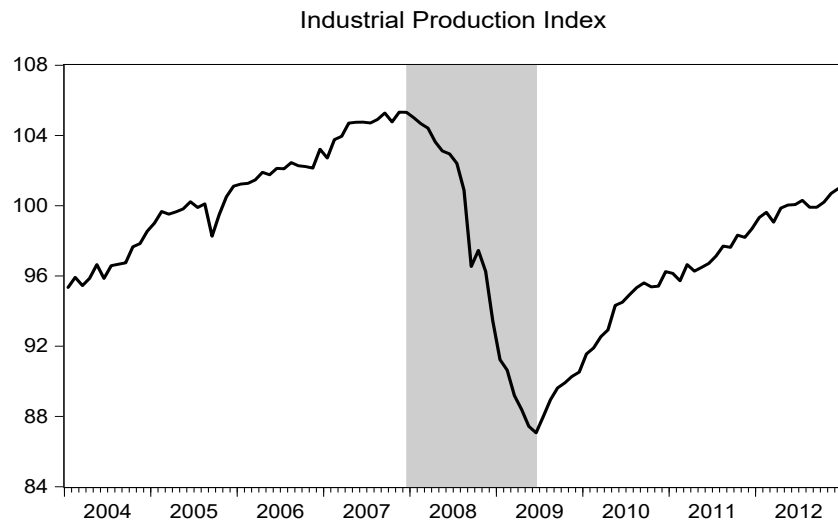

Figure 36.6: Industrial Production Index Around Great Recession



In terms of lost output, the Great Depression was *significantly* worse than the Great Recession. By some measures, the unemployment rate during the Great Depression topped 25 percent, whereas it only maxed out at 10 percent in the most recent crisis. A consensus among economists is that the Great Depression was as bad as it was because of poor policies. [Friedman and Schwartz \(1971\)](#) argue forcefully that mistakes by the Federal Reserve (which was only in its second decade of existence when the Depression hit) significantly worsened the Depression. The Fed did not, they argue, fully understand its role as lender of last resort. It allowed many banks to fail and the money supply to consequently contract with dire economic consequences. In contrast, during the more recent crisis, the Federal Reserve went

out of its way to try to provide stimulus to the economy. While it is still a matter of some debate, many economists (ourselves included) believe that the Great Recession was not as bad as it might have been because of the extraordinary policy actions taken by the Fed. We will discuss some of these extraordinary policy actions in more depth below.

36.2 The Great Recession: Some More Specifics on the Run

In this section we provide a somewhat more detailed overview of the events leading up to the Financial Crisis of 2007-2009. This section is meant as a complement to the rest of this chapter. Our analysis follows the narrative from [Mishkin \(2011\)](#) and [Gorton \(2010b\)](#) pretty closely. The interested reader is referred to these works for more detail. Our central thesis follows from these authors and is that the financial crisis was a “run” on the shadow banking system. This run resulted in widening credit spreads which had adverse macroeconomic consequences, particularly when combined with a binding zero lower bound on interest rates.

The Financial Crisis had its origins in the housing market. As shown in [Figure 36.2](#), home prices started to level off towards the end of 2005 and into 2006 and soon thereafter began to decline. Any successful narrative of the crisis must account for why declines in housing prices led to widespread financial panic and runs on financial institutions. While large, on its own the amount of outstanding mortgage related debt was not large enough to bring down the entire financial system.

How the collapse in housing prices led to a widespread financial panic relates back to several changes in the financial system that had been ongoing for several years. Some of these are detailed in [Section 30.4](#) of [Chapter 30](#). A significant fraction of credit intermediation had moved out of the traditional, regulated banking sector into the so-called shadow banking sector. Institutions like the now defunct investment banks (e.g. Bear Stearns and Lehman Brothers) essentially provided the funding for mortgage loans by buying mortgage backed securities. These institutions in turn funded themselves with short term loans from large institutional investors (like pension funds). These short term loans were often in the form of repurchase agreements (repos). In a repo, one party lends another money (often overnight, but never for a very long maturity) at a pre-negotiated interest rate. What makes this loan safe is the posting of collateral by the borrower – in the event that the borrower does not make good on its promised repayment, the lender gets to keep the collateral.

The rise of large, institutional investors created a demand for “deposit-like” assets. These large institutional investors might have several hundred million dollars on which they would like to earn a safe interest rate before deciding what to do with it. Because deposit insurance will not cover deposits over \$250,000, traditional bank deposits are not safe ways to earn

interest on vast sums of money. Short term repurchase agreements emerged to fill this void – one party lends to another short term, and what makes the loan safe is the collateral that the borrower posts. This created a demand for relatively safe assets to serve as a collateral – the US government does not provide enough Treasury securities to meet the demand for relatively safe collateral that currently exists. Securitized mortgages came to be seen as a good form of collateral to make the short term funding from things like repo agreements viable. In other words, the demand for “deposit-like” assets was met with securitization of mortgages to serve as collateral to make these short term assets safe. For this reason, [Gorton \(2010a\)](#) refers to the shadow banking system as a system of “securitized banking.”

As was done in Chapter 30, it will be helpful to illustrate these concepts through an example. Suppose that there is an investment bank, call it Bear Stearns, which holds mortgage backed securities (MBS). It finances the purchase of these securities with short term funding, for example in the form of repurchase agreements. Suppose that the counterparty providing Bear with Repo is a large institutional investor, call it Fidelity. The balance sheet of Bear might look like:

Table 36.1: T-Account for Bear Stearns

Assets	Liabilities plus Equity
MBS \$500	Repo: \$500
Other Securities: \$100	
Cash: \$100	Equity \$200

In this example, which is slightly different than what appears in Chapter 30, Bear holds \$700 million in assets and has \$500 million in liabilities, with \$200 million in equity. \$500 million of its assets are MBS, while another \$100 million are held in other financial securities (say, AAA rated corporate bonds) and \$100 million is in cash. Bear finances itself with \$500 million in repo, for which the \$500 million in MBS serve as collateral. Bear is in essence borrowing (at the repo rate) to finance its holdings of MBS. If the MBSs and other securities yield more than Bear has to pay for the Repo, then Bear turns a profit from this transaction – it is in essence borrowing low (at the repo rate) and lending high (at whatever the yield on the MBSs is). This is also a good deal for Bear’s counterparty, in this example Fidelity. Fidelity gets to earn some interest while it parks \$500 million in cash. This “deposit” is safe so long as Bear does not fail and the underlying collateral does not lose value.

What triggered the panic, and why did it extend beyond just mortgage-related debt products? How did a decline in house prices bring the entire financial system to its knees? Mortgage backed securities are based on underlying actual mortgages. Some of these mortgages were to so-called “subprime” borrowers – borrowers either with poor credit histories, little

money down (i.e. little or no equity in their home), low incomes, or a combination of all these. The structure of many of these so-called subprime loans made the cash flows from the underlying mortgages particularly sensitive to house prices. In essence, borrowers could get a loan at essentially no money down with a low interest rate, often called a “teaser rate.” For example, suppose that you purchase a home for \$500,000, and that the monthly mortgage payment on a conventional loan (e.g. a thirty year fixed rate mortgage with a 20 percent downpayment) would be \$2500. You can afford up to a \$2500 monthly payment, but you do not have the resources to make a downpayment. You would therefore not be able to purchase this home with a traditional mortgage. Would buying this house with a non-traditional mortgage make any sense? Suppose that you can get a no money down loan for a period of two years where the monthly payment is only \$2500 a month, which you can afford. The interest rate is scheduled to “reset” in two years which would raise the monthly payment to \$3000, which you cannot afford. If the house appreciates in value, to say \$650,000 within the next two years, you can refinance the loan. In a refinance, you take out a new loan to pay off an existing loan. Your existing loan is valued at \$500,000, so you need a loan for this amount. But if the home is now worth \$650,000, the loan you are taking out is 75 percent of the value of the asset under consideration. This allows you to refinance at an interest rate you can afford, and you can keep your house payment at \$2500 a month. In essence, you can use the accumulated equity in your home as a down payment on the refinance deal.

This all works out as planned so long as the home appreciates in value. But what if it doesn't, or worse yet declines in value? Then you are in trouble. If the home does not appreciate in value, you cannot refinance the loan at more favorable terms after two years – you have no equity built up in the home. This means that your monthly payment resets to \$3000 a month, which you cannot afford. You have no choice but to default on the home – i.e. quit making payments, at which point a bank seizes the property. If you quit making payments, whoever owns the mortgage loan will experience lower cash flows than anticipated. In a traditional setting, the bank issuing the loan would have suffered this loss. But with securitized banking, the mortgage issuer did not have a claim to the cash flows from your mortgage, which had instead been pooled together with other mortgages into mortgage backed securities. This meant that whoever owned the MBS would suffer a loss. In the hypothetical example above, the owner of the MBS is the investment bank Bear Sterns.

Bear Sterns and other financial institutions were heavily exposed to MBS, the cash flows of which were in turn quite sensitive to declines in home prices. The decline in home prices triggered a run because large institutional investors became worried that the MBS which were serving as collateral for repo agreements were not worth what they thought. This led to a drying up of short term funding for institutions like Bear Sterns, in a way conceptually

isomorphic to a mass withdrawal of deposits from a traditional bank. It did not matter that subprime mortgages were a small fraction of outstanding mortgage debt, or that only a small minority of mortgages ever actually went into delinquency (late on payments) or outright default (failure to make promised repayments). Large institutional investors knew that there were some “bad” mortgage loans out there, but were not sure where. As a consequence, they did not want to accept MBS as collateral, and short term funding for institutions like Bear dried up. [Gorton \(2010a\)](#) has likened this to an e-coli scare – even if you know that most beef does not have e-coli, because you are not sure where the e-coli is, you decide to stop purchasing all beef. In a similar way, even though investors knew that most mortgage-related debt was sound, they knew there was some bad debt out there, and decided to not accept any mortgage debt as collateral.

As discussed in Chapter 30, an important feature of repurchase agreements is the haircut, which is defined as the percentage difference between the amount of a loan and the required collateral. Fearing that their counterparties were at risk and that the underlying collateral was not valuable, short term funders (like Fidelity in the example) began demanding haircuts on repurchase agreements. Prior to the crisis, haircuts were zero. At the height of the crisis, haircuts rose to more than 40 percent. A 40 percent haircut would mean, for example, that Fidelity would only lend Bear \$300 million in exchange for \$500 million in MBS. Figure 36.7 plots the average repo haircut and is taken from [Gorton \(2010a\)](#).

Figure 36.7: Repo Haircuts During the Crisis

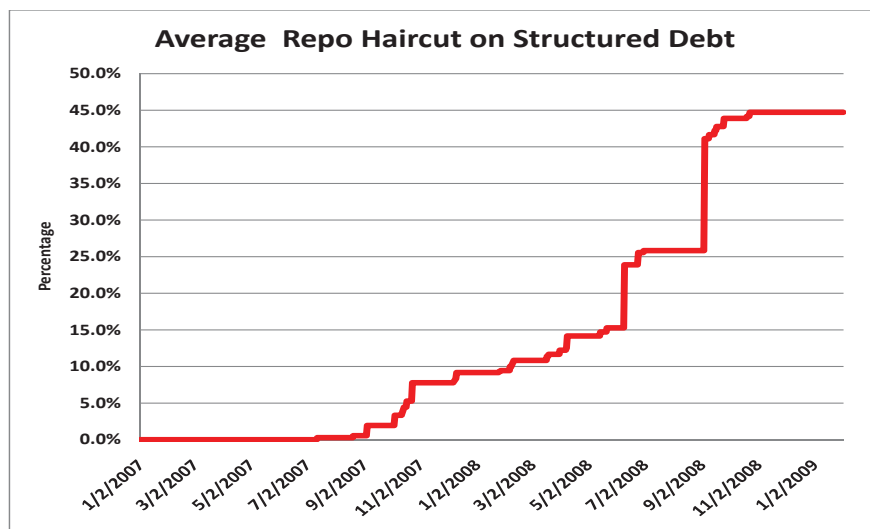

Let us return to the balance sheet for Bear Stearns in our example. Suppose that rather than fully “rolling” the loan, Fidelity demands a 40 percent haircut. This means that it will only lend \$300 million in exchange for \$500 million in collateral. This requires Bear to come

up with \$200 million in cash (to pay off the existing repo of \$500 million when it only gets \$300 million when the loan is rolled with a 40 percent haircut). In Table 36.1, Bear only initially has \$100 million in cash. Suppose that it can sell its other securities at their market value to raise the other \$100 million. Its new balance sheet would look like:

Table 36.2: T-Account for Bear Stearns

Assets	Liabilities plus Equity
MBS \$500	Repo: \$300
Other Securities: \$0	
Cash: \$0	Equity \$200

In this situation, Bear is close to being in trouble. Any more withdrawal of funds by refusing to roll over short term funding, or only doing so with an even higher haircut, would lead Bear into failure. This is, in fact, what happened. As Bear (and other institutions) tried to come up with cash to meet short term funding shortfalls, they sold assets unrelated to mortgage backed securities (like AAA rated corporate debt). When many financial institutions try to sell assets at the same time, the price of these assets declines. This creates a feedback effect where declines in the price of these assets make these institutions look ever more vulnerable, which could lead to further pressures on short term funding and even more asset sales. As documented by Gorton (2010a), this resulted in an apparently perverse outcome – yields on AAA rated corporate debt were higher (prices were lower) than yields on AA rated corporate debt, as can be seen in Figure 36.8. This occurred because institutions, facing liquidity pressures, naturally tried to first sell their “best” assets to raise cash. But as many institutions tried to do the same thing all at once, the price of these assets declined (and associated yields went up, as bond prices and yields move opposite one another, as discussed in Chapter 33).

Figure 36.8: AA-AAA Spread

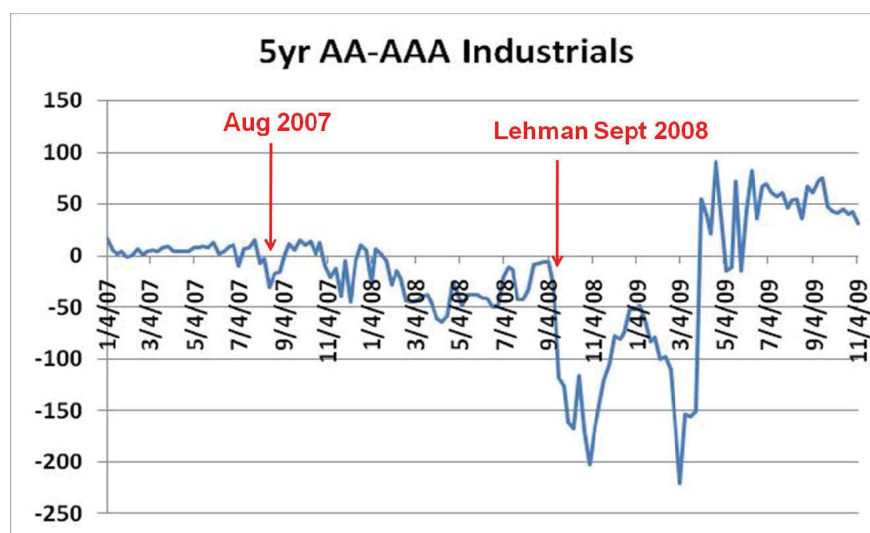

In summary, things spread from housing related debt to a more general financial crisis because of concerns about the backing collateral in short term debt agreements between financial institutions. This led to a drying up of short term funding, which forced some institutions to try to sell assets to raise cash. This selling of assets further depressed asset prices (and increased yields) and put more liquidity pressures on the institutions. Financial institutions quit lending – both to one another as well as to consumers and businesses with legitimate needs for credit. As a consequence, credit spreads throughout the economy rose.

Figure 36.9 plots the *daily* spread between the 3 month LIBOR (London Interbank Offer Rate) and the 3 month Treasury Bill. This is commonly referred to as the “TED Spread.” The 3 month LIBOR rate is an interest rate used for interbank lending. We can see that this series displays many similarities with the BAA-Treasury spread shown in Figure 36.4 (which is plotted at a monthly frequency). The first signs of the crisis appeared in early August of 2007, when the French bank BNP Paribas suspended redemption of funds held in its money market mutual funds. This was cited as being due to concerns of the US mortgage market. We see an immediate upward-tick in the spread from about 0.5 to more than 2. Things quieted down somewhat but remained volatile for the next several months. The next big shock to the system was the failure and engineered bailout of US investment bank Bear Stearns, which was heavily exposed to MBS and which faced a funding shortfall. Bear Stearns was bailed out in mid-March of 2008 with a sale to JP Morgan coordinated by the Federal Reserve. We can again see a massive and very quick increase in spreads as evidence of strain in interbank lending markets immediately after the Bear Stearns bailout. Things again quieted down but remained volatile over the summer.

Figure 36.9: The TED Spread During the Financial Crisis

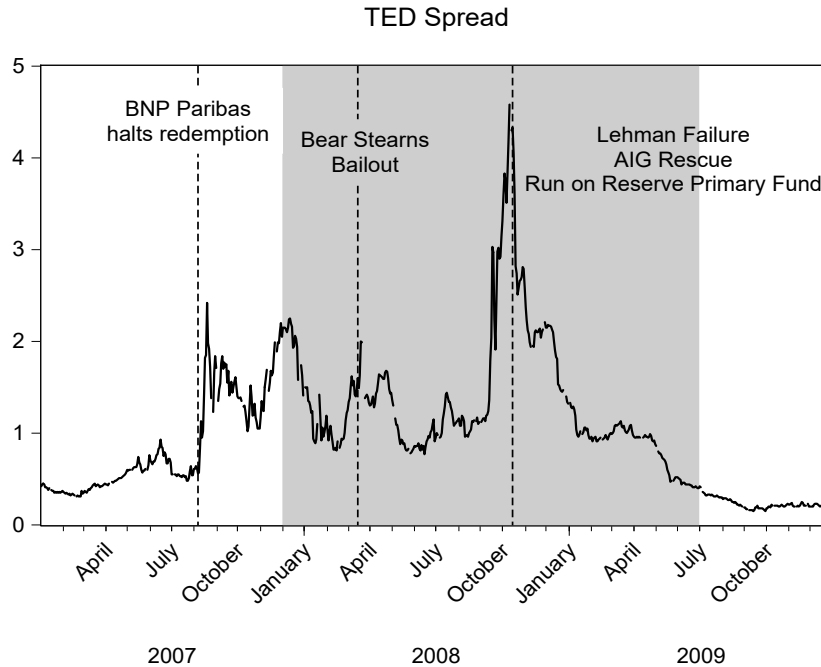

The financial crisis (and indeed the recession) entered its most virulent phase in the fall of 2008. We can see this in the behavior of the daily TED spread during this time. On September 15, 2008, the investment bank Lehman Brothers went into bankruptcy. This proved an enormous shock to the system. Especially after Bear Stearns in March of the same year, market participants evidently did not believe that the Fed would allow a large financial institution to fail. Lehman was allowed to fail because the Fed could not find an interested buyer, because it doubted the legality of its taking over an investment bank, and because it wanted to send a signal to the markets that it would not simply bail out any institution that got into trouble. The Lehman failure proved disastrous, and was followed the next day by the bailout of AIG (a global insurance conglomerate which had written what essentially amount to insurance products – credit default swaps – on mortgage related securities) and the Reserve Primary Fund “breaking the buck.” The Reserve Primary Fund was one of the original money market mutual funds, which seek to maintain a net asset value (NAV) of \$1 – i.e. total assets divided by total shares equals \$1. Its asset values declined and funding dried up. Financial institutions of all stripes were trying to sell assets and draw back on credit extension. As a result, the interest rates relevant for consumer and business loans increased markedly.

Things began to stabilize in financial markets as the calendar moved to 2009, and by the summer of that year the TED spread was lower than it had been prior to the crisis.

To a large extent, we feel that this moderation in spreads was due to the extraordinary rescue interventions by the Fed and other government agencies. We discuss this below after employing our New Keynesian AD-AS model to think about the macroeconomic consequences of the financial crisis.

36.3 Thinking About the Great Recession in the AD-AS Model

Having provided some background detail, we now proceed to employ the New Keynesian IS-LM-AD-AS model, augmented to account for an exogenous credit spread as in Chapter 35, as a lens through which to think about the Great Recession. We do so with the obvious caveat that the model is an abstraction of a very complicated reality. Nevertheless, we feel that the model does a good job at making sense of what happened, and, given that, the model can be used to think about the unconventional policies tried by the Fed in the aftermath of the crisis.

Roughly speaking, the Great Recession can be divided into three stages. The first stage was the housing bust which began in late 2006 and continued throughout 2007. The second stage was the financial crisis, which began in late 2007 and intensified throughout 2008. The third and most virulent stage is the further intensification of the financial crisis at the end of 2008 and into the first half of 2009, exacerbated by the fact that the zero lower bound on interest rates had become binding by the end of 2008.

As shown above in Figure 36.2, home prices in the US began to decline in 2006 and continued the decline throughout 2007. The direct macroeconomic consequences of the home price decline were not large. As discussed in Chapter 9, wealth more generally, and housing in particular, can be an argument in a household's consumption function. A decline in house prices represents a reduction in wealth, which, other factors being equal, ought to reduce consumption demand. In terms of our graphical model, this would result in an inward shift of the IS curve and a resulting inward shift of the AD curve. This is documented in Figure 36.10 below. The figure focuses just on the IS-LM and AD-AS diagrams, and abstracts from diagrams related to the labor market. The inward shift of the AD curve resulted in a lower level of interest rates and a mild slowdown in output, although the slowdown in output was barely perceptible.

Figure 36.10: 2007 Decline in House Prices

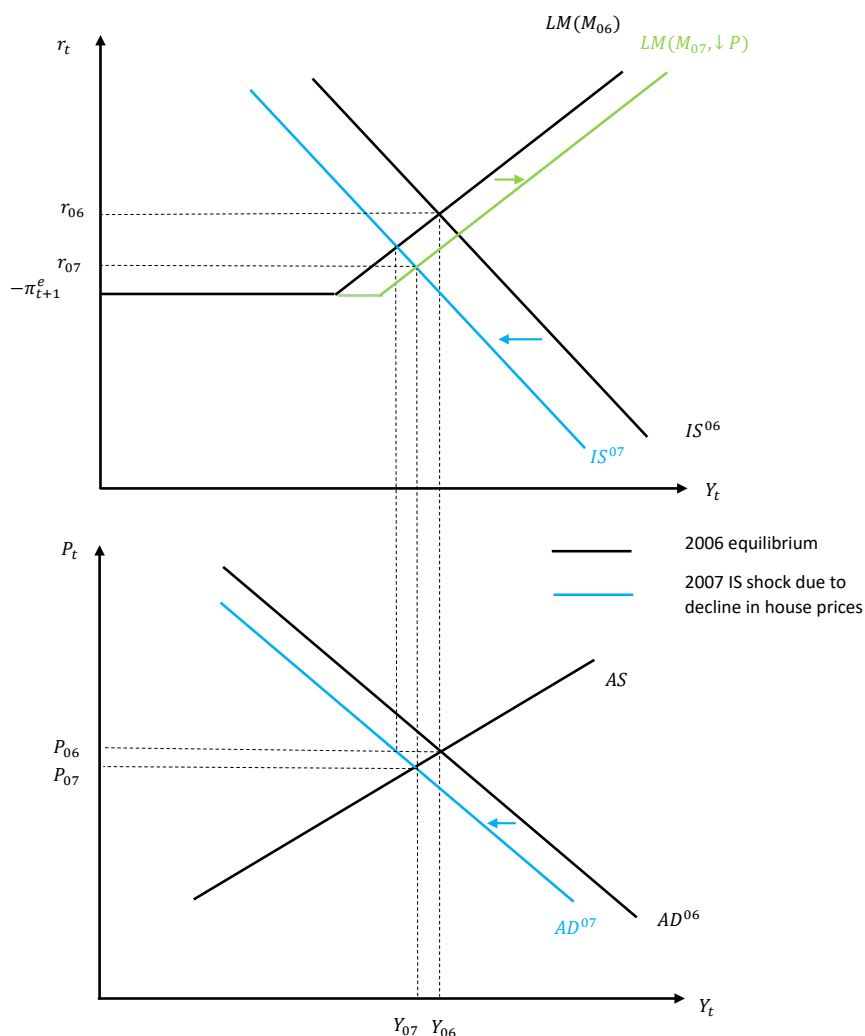

If the decline in house prices were all that happened, there may not have even been a recession and it certainly would not have been described as “Great” after the fact. The Great Recession entered a more pernicious stage in late 2007 and throughout 2008. As noted in the section above, declines in housing prices nationwide raised concerns of solvency risks for counterparties in interbank lending markets. This precipitated what amounted to a conventional bank run, although it was a run of institutions on other institutions and did not revolve around deposits. As a consequence of the liquidity crisis, financial institutions were forced to sell assets to raise cash. Loan supply was significantly reduced, and credit spreads increased. The increase in credit spreads, measured by the variable f_t in our model, would result in a further inward shift of the IS and AD curves. This is documented in Figure 36.11 below.

Figure 36.11: 2007-2008 Financial Crisis

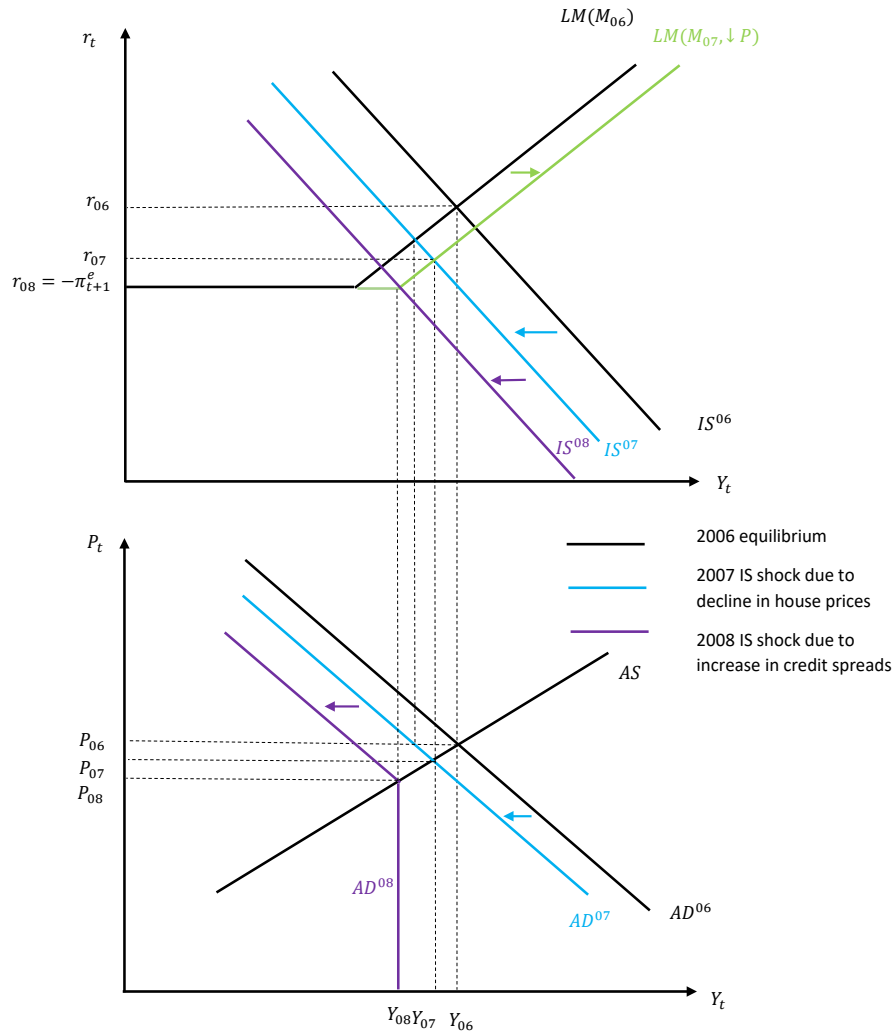

The increase in credit spreads further shifted the IS curve in to the left, with a resulting inward shift of the AD curve. Output began to contract, albeit not particularly significantly yet. What is important is that, by the fall of 2008, interest rates had been moved close to zero. In other words, by the end of 2008 the ZLB was binding, which means that the economy's equilibrium was at the vertical portion of the AD curve (and the flat portion of the LM curve). Figure 36.12 below plots the time series of the Federal Funds Rate. We can see that the rate was moved essentially to zero by the later part of 2008 and remained there until the end of 2015 (which is not shown in the figure).

Figure 36.12: Federal Funds Rate Around Great Recession

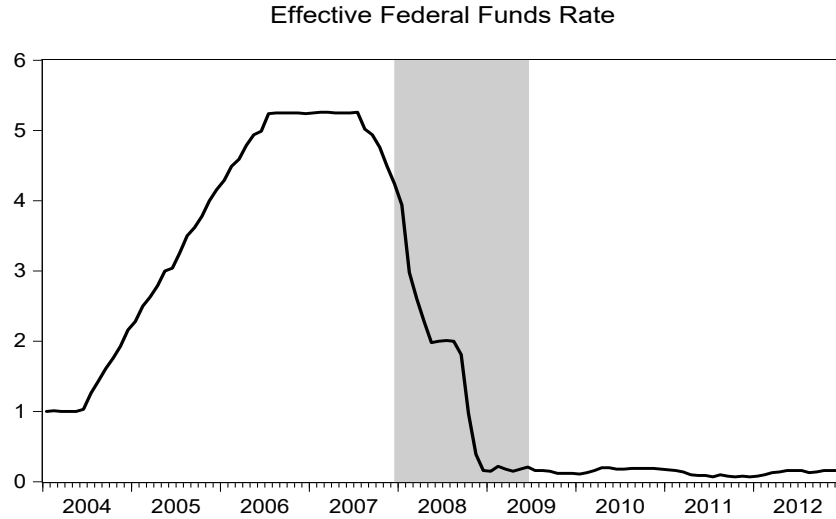

Things got worse in the fall of 2008 – this is detailed in the section above with the failure of Lehman Brothers, the rescue of AIG, and the run on the Reserve Primary Fund in September of that year. Things were also exacerbated by the uncertainty surrounding the government’s planned rescued packages (to be discussed more in the section below). From Figure 36.4 above, one can see that while credit spreads increased over 2007 and the first half of 2008, the biggest increase in credit spreads was at the end of 2008 and persisted into 2009. The intensification of the financial crisis can be mapped into the model with a further increase in f_t moving from 2008 into the first half of 2009. This is shown below in Figure 36.13.

Figure 36.13: The ZLB and the Intensification of the Financial Crisis in 2008-2009

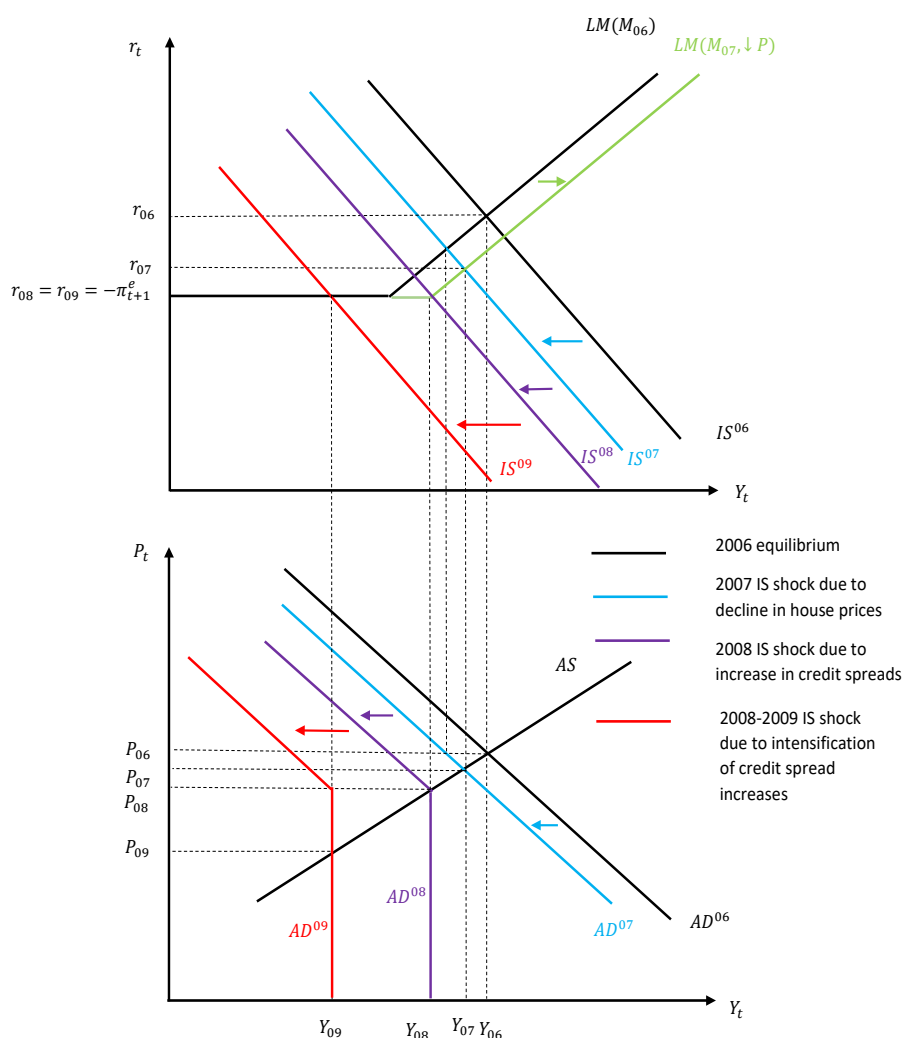

An important point to be emphasized is that the effects of the financial crisis, as manifested in higher credit spreads in late 2008 and into the first half of 2009, were exacerbated by the fact that the ZLB was binding by the end of 2008. In Chapter 28 we showed how the economy is particularly susceptible to negative IS shocks at the ZLB. In normal times, negative IS shocks (as for example would happen with an increase in f_t) are partially offset by lower interest rates. But at the ZLB this is not possible. Hence, the AD curve shifts in significantly more after a negative IS shock when the ZLB binds in comparison to normal times. This is documented in Figure 36.14. This figure shows the effects of an increase in f_t both with the ZLB binding (as characterized the US economy at the end of 2008) compared to a situation in which the ZLB does not bind (as indicated by dashed lines in the figure). Our model would predict that output would have reacted much less to the increase in credit spreads had the ZLB not been binding.

Figure 36.14: Intensification of the Financial Crisis in 2008-2009 with and without the ZLB

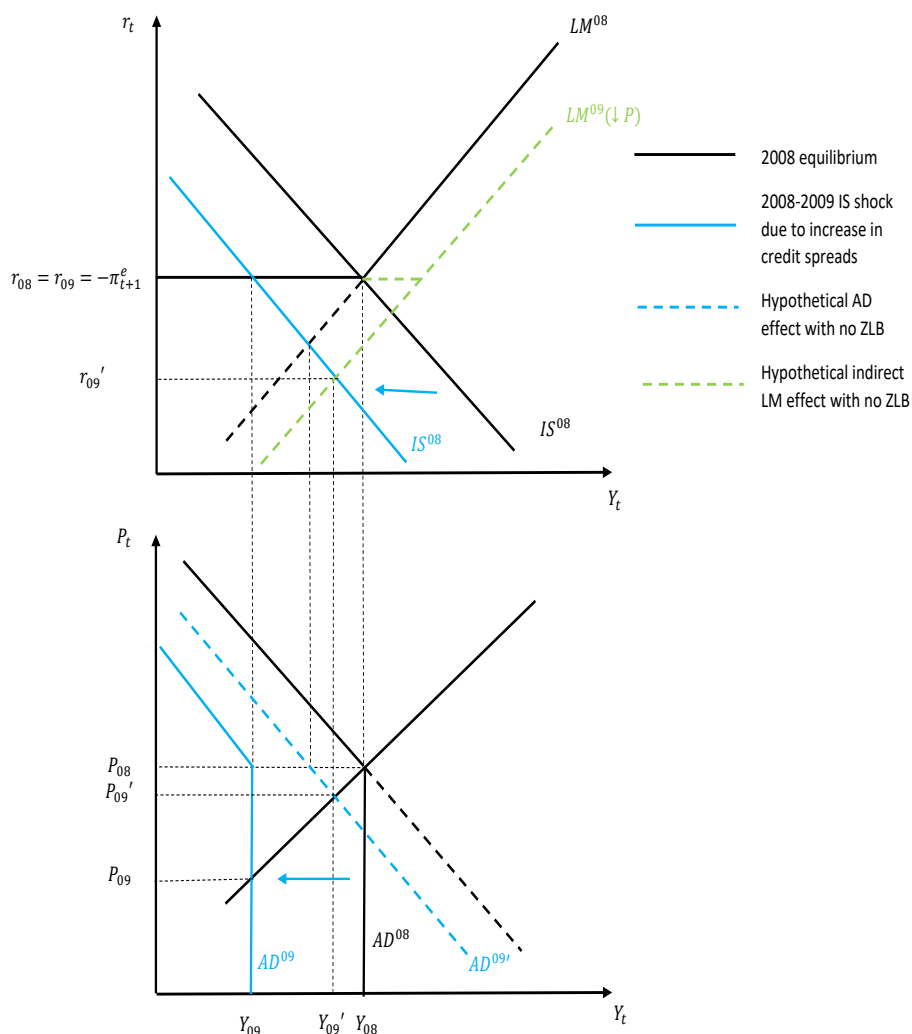

Overall, the model, in spite of its simplicity, can provide a fairly good account of what actually happened during the Great Recession. Output declined throughout 2008, but most precipitously toward the end of 2008 and early 2009 when the ZLB was binding. This is consistent with the predictions of the model. What about the behavior of prices? Figure 36.15 plots the Personal Consumption Expenditure price deflator (solid dark line, left scale) and the annualized rate of change in this price index (blue line, right scale). As our simple model would predict, the price level declined fairly significantly in the second half of 2008 and into the early part of 2009. Outright declines in the price level are rare in post-Depression US business cycles. The inflation rate went from mildly positive before and during the early stages of the recession to sharply negative at the end of 2008.

Figure 36.15: Price Level and Inflation Rate Around Great Recession

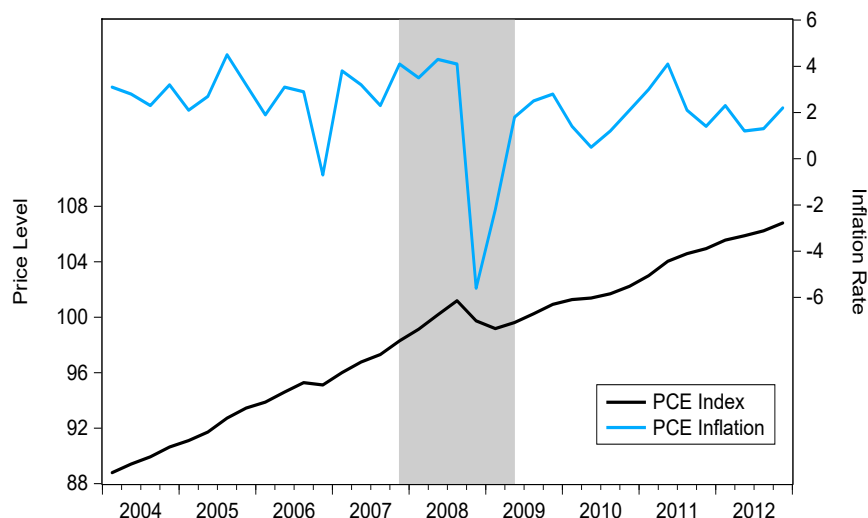

The model is of course not a perfect description of reality. While there were concerns to this effect, the economy never went into a deflationary spiral as described in Chapter 28. Indeed, survey measures of inflation expectations remained high during and in the immediate wake of the Great Recession, much higher than most models would have predicted (Coibion and Gorodnichenko 2015). Second, even though the ZLB continued to bind through the end of 2015, the economy began to recover in the second half of 2009. This is not necessarily consistent with our basic analysis laid out in Chapter 28, wherein an economy will not recover on its own after a series of negative demand shocks when the ZLB binds. The fact that the economy did start to recover could be evidence against the validity of the model, or it could be evidence supporting a conclusion that the unconventional policy actions taken (to be discussed below) had some beneficial effects.

While output did begin to recover in the second half of 2009, the recovery was not robust. In Figure 36.16, we plot the natural log of real GDP in and around the Great Recession. We also show, in a dashed line, a hypothetical trend level of GDP beginning with the onset of the Great Recession. This trend line is computed by taking the average growth rate of GDP from 2004-2007 and assuming that it would have continued after 2007. Relative to trend, GDP fell by roughly 10 percent by the middle part of 2009. While real GDP did begin to grow at that point, it did not grow fast enough to “catch up” to the hypothetical trend line. Several years after the recession (and indeed continuing to the present day), GDP remained 10 or more percent below a hypothetical pre-Recession trend line.

Figure 36.16: Real GDP and Hypothetical Trend

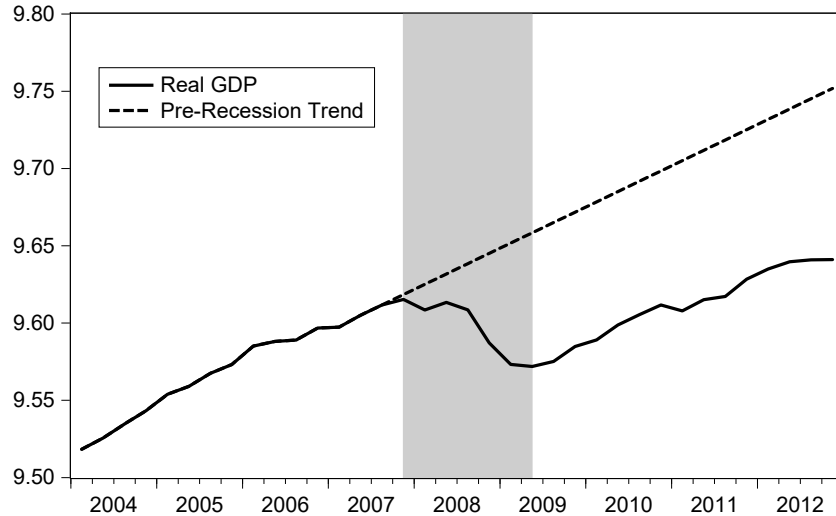

36.4 Unconventional Policy Actions

The financial crisis and ensuing Great Recession spurred several policy actions. Some of these were fairly standard (e.g. the Fed cutting interest rates), but the causes, severity, and ZLB problems associated with the Great Recession dictated more than conventional policy actions.

The conventional policy action was monetary accommodation and the cutting of the Fed’s key policy interest rate, the Fed Funds Rate. As documented in Figure 36.12, the Fed lowered the Fed Funds Rate from about 5 percent prior to the start of the crisis to zero by the end of 2008. We can divide the “unconventional” policy actions into roughly three groups. The first involved the Fed’s extraordinary rescue actions and attempts to provide liquidity to interbank lending markets. These actions were warranted given that the cause of the crisis was essentially a wholesale run by some financial institutions on other institutions. The Fed was merely acting as a lender of last resort. The second involved fiscal stimulus. Most economists would agree that monetary policy should be the first line of defense against a recession. During a time where monetary policy is constrained by the ZLB, fiscal policy may not only be the only available tool but might also be more effective in comparison to normal times. Finally, the third set of policies involved unconventional monetary policies – principally forward guidance and quantitative easing. These were attempts to lower *longer term* and *risky* interest rates without the usual channel of lowering short term and riskless interest rates like the Fed Funds Rate (which was an action not available to policy makers because of the ZLB). Quantitative easing and forward guidance are also discussed in some detail in Chapter 33.

We will discuss each of these three broad areas of unconventional policy in the subsections below. There is a common theme to the different policy interventions, however. In particular, they were all designed to stimulate demand through shifting the IS curve. This makes some sense given that the conventional story about the cause of the recession was an adverse shock to the IS curve (i.e. an increase in credit spreads, f_t). What is unconventional about these policies is that the typical policy response to a recession centers on using monetary policy to stimulate demand through shifting the LM curve. This policy option was not on the table due to the zero lower bound problem.

36.4.1 Federal Reserve Lending

The financial crisis was essentially a *liquidity crunch*. Fearing losses related to mortgage-related securities, short term funding for financial institutions dried up and these institutions were forced to sell assets to raise cash. It was essentially a classic bank run, only it was a run of institutions on other institutions, as opposed to a run of depositors on conventional banks (as in the Great Depression, for example).

There was a run on the shadow banking system, and not on commercial demand deposits, because there is nothing akin to deposit insurance for short term funding markets like repurchase agreements and commercial paper. As discussed at the end of Chapter 32, outside of deposit insurance and suspension of convertibility, the classic way to deal with a run is for the central bank to step in as the lender of last resort. The basic mechanics of this are for the central bank to step in and lend funds to financial institutions facing funding shortfalls. This lending would allow these banks to come up with the cash to meet their short term funding shortfalls without having to sell assets. The hope is that by encouraging institutions to *not* sell assets, asset prices will remain high, yields low, and credit will continue to flow.

The Fed engaged in several extraordinary lending programs at the height of the financial crisis. Our objective is not to provide great detail on all of these lending programs, but rather to give a broad overview and highlight a few important ones. The traditional means of lending as a last resort is through the Fed's discount window. Banks can go to the discount window and get loans at the discount rate, allowing them to deal with temporary liquidity shortfalls. For a couple of reasons, the discount window itself was not particularly important during the financial crisis and ensuing Great Recession, although emergency lending and liquidity provision was. Banks have always been weary of a "stigma" attached to going to the discount window, fearing that other market participants gaining knowledge of this would lead the market to perceive an institution as weak. Second, because the "run" during the Great Recession happened outside of the conventional banking sector, the institutions facing

short term funding shortfalls were not designated as commercial banks and as such were not eligible for conventional discount loans.

The Fed got around these issues and extended credit to the financial system more generally in several different ways. Relatively early in the crisis, in December of 2007, the Fed established the [Term Auction Facility](#) (TAF). The TAF distributed loans to banks through a competitive auction process, and did so in a way that the anonymity of firms receiving loans was maintained (in contrast to traditional discount window lending). The TAF was quite successful – at its height, more than \$400 billion in credit was extended through this facility. Other non-traditional lending facilities were designed to open Fed lending to more than just commercial banks. For example, the [Primary Dealer Credit Facility](#) (PDCF) was a program designed to lend to institutions which did not have access to the discount window. In the solid black line in Figure 36.17, we plot the total credit outstanding from the Fed to financial institutions. This went from under \$100 billion prior to the crisis to about \$1.5 trillion at the height of the crisis at the end of 2008. This series returned to more normal levels by the end of 2009. These data are available for download from the [Federal Reserve Bank of Cleveland](#).

Figure 36.17: Emergency Fed Lending

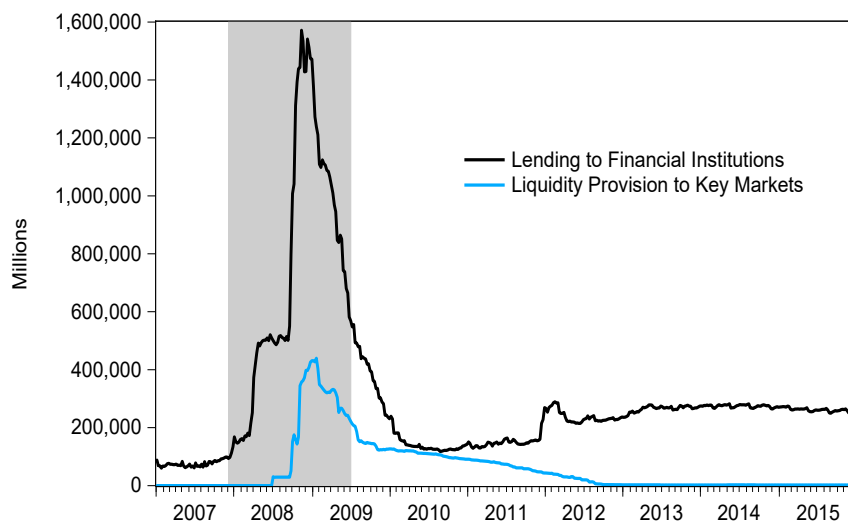

In addition to traditional outright lending, the Fed also engaged in similar programs to extend liquidity to key markets. For example, the [Asset Backed Commercial Paper Money Market Lending Facility](#) (AMLF) lent money to institutions where the lent money was designed to purchase asset-backed commercial paper from mutual funds. This was in response to large scale withdrawals from mutual funds, and was designed to stem the run on these funds. The [Term Asset Backed Securities Lending Facility](#) (TALF) was a facility designed to improve consumer credit. The idea was to purchase asset backed securities (for example

based on credit cards and student loans). The liquidity from these purchases would hopefully spur lending to households and businesses. The [Commercial Paper Funding Facility](#) (CPFF) was similar in that it purchased commercial paper, with the idea being that this would increase issuance of commercial paper (short term unsecured corporate debt). Finally, the Fed created several special purpose vehicles by the moniker [Maiden Lane](#) to extend credit to failing financial institutions like Bear Stearns and AIG. Total liquidity provision exceeded \$400 billion at the height of the crisis. It is plotted in the solid blue line in [Figure 36.17](#).

All told, the Fed directly lent or injected close to \$2 trillion into private financial markets through its extraordinary lending facilities. This lending peaked at the height of the crisis (end of 2008 and into early 2009), and was essentially back to normal levels by 2012. The objective of all this new lending was to restore calm and liquidity to financial markets and to get financial institutions lending again. In terms of the AD-AS model, we can think about Fed lending and rescue operations as in essence trying to *reverse* the increases in credit spreads (f_t in our notation) that characterized the height of the recession. Especially to the extent to which the crisis was triggered by an increase in credit spreads, this policy makes a lot of sense. [Figure 36.18](#) plots in an AD-AS diagram the desired effects of the Fed's lending activities taking the 2009 equilibrium as a starting point. We can think of the extraordinary lending activities as essentially attempts to reduce f_t , which would work to undo the inward shift of the IS and AD curves due to the financial crisis.

Figure 36.18: AD-AS Effects of Federal Reserve Lending Programs

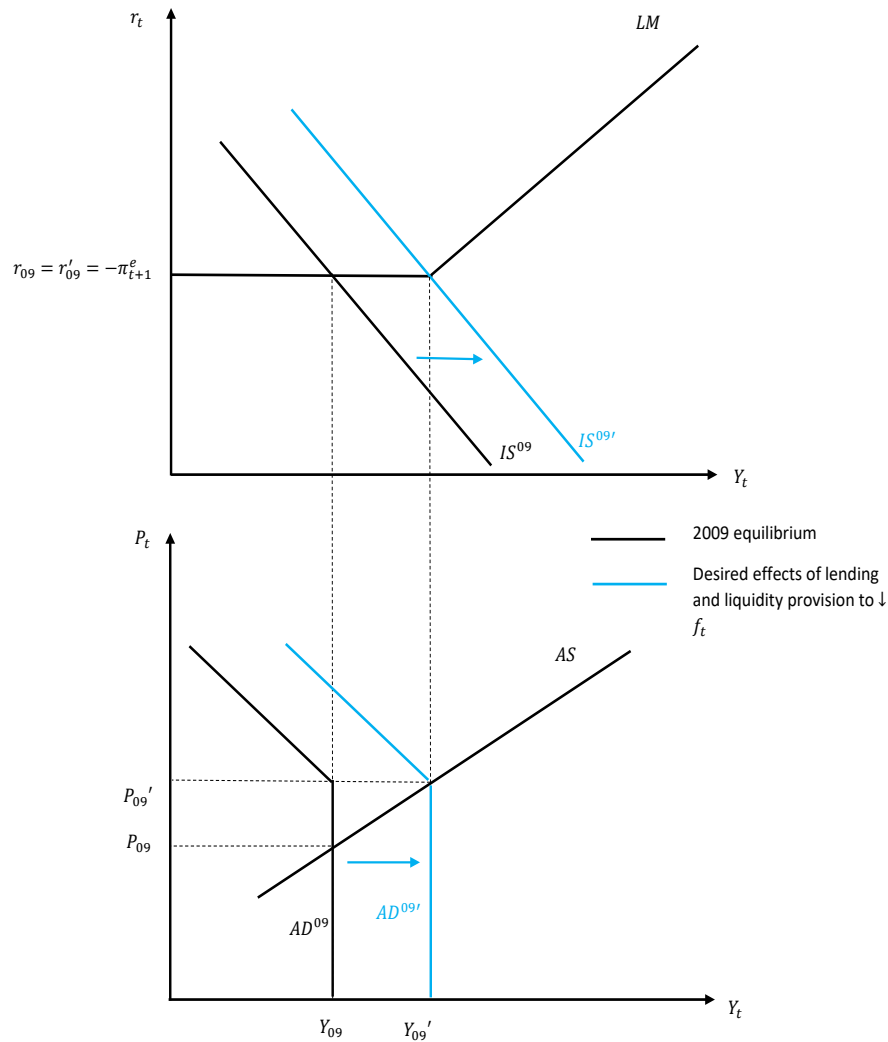

Were these lending activities successful at stimulating the economy and preventing the recession from being much worse? The data are seemingly consistent with this hypothesis. As can be seen in Figures 36.4 and 36.9, credit spreads were back to normal levels by the end of 2009 and early 2010, which coincides with the period in which the Fed pulled back on its extensive lending to the financial markets. Furthermore, output and labor market variables began to stabilize in the middle of 2009, shortly after many of the Fed's new lending facilities had been put into place.

36.4.2 Fiscal Stimulus

Most economists prefer monetary policy as the principal tool to fight recessions. But in extreme circumstances, using stimulative fiscal policy (some combination of increasing

government spending and reducing taxes) might make sense and even could be quite desirable. These circumstances include a situation in which monetary policy is constrained by the zero lower bound, which characterized the US economy from the end of 2008 through 2015.

The [American Recovery and Reinvestment Act](#) (ARRA) was the “stimulus package” passed by Congress and signed into law by then President Obama in early 2009. This bill was in response to the financial crisis and Great Recession, which was in its most virulent phase at the time of the bill’s passing. The Recovery Act was designed to inject roughly \$800 billion in stimulus into the economy over a ten year period starting in 2009. A little more than half of this was designed to be federal spending, particularly on infrastructure, while the remainder was split between tax credits, tax cuts, and federal subsidies for state and local spending.

In the context of our AD-AS model, where we presume Ricardian Equivalence holds, we have to focus on the spending-based features of the Recovery Act. We can simply think of the Act as engineering an increase in G_t . In ordinary times, this would cause the IS curve to shift to the right and the AD curve to shift to the right as well, although the rightward shift of the AD curve would be smaller than the shift of the IS curve because of “crowding out” associated with increases in the real interest rate. At the ZLB, in contrast, the vertical AD curve ought to shift out horizontally to the right by the same amount as the shift of the IS curve because there is no crowding out if the interest rate is fixed at its lower bound (provided the shift of the IS curve is not so large as to make the ZLB no longer binding). In essence, this is just the reverse of what is documented in [Figure 36.14](#) above – IS shocks (whether emerging from changes in f_t or G_t) have bigger effects when the ZLB binds than when it does not. This suggests that fiscal stimulus might be particularly effective at influencing output when the economy is at the ZLB (see, e.g. [Christiano, Eichenbaum, and Rebelo 2011](#)).

Figure 36.19: AD-AS Effects of Fiscal Stimulus

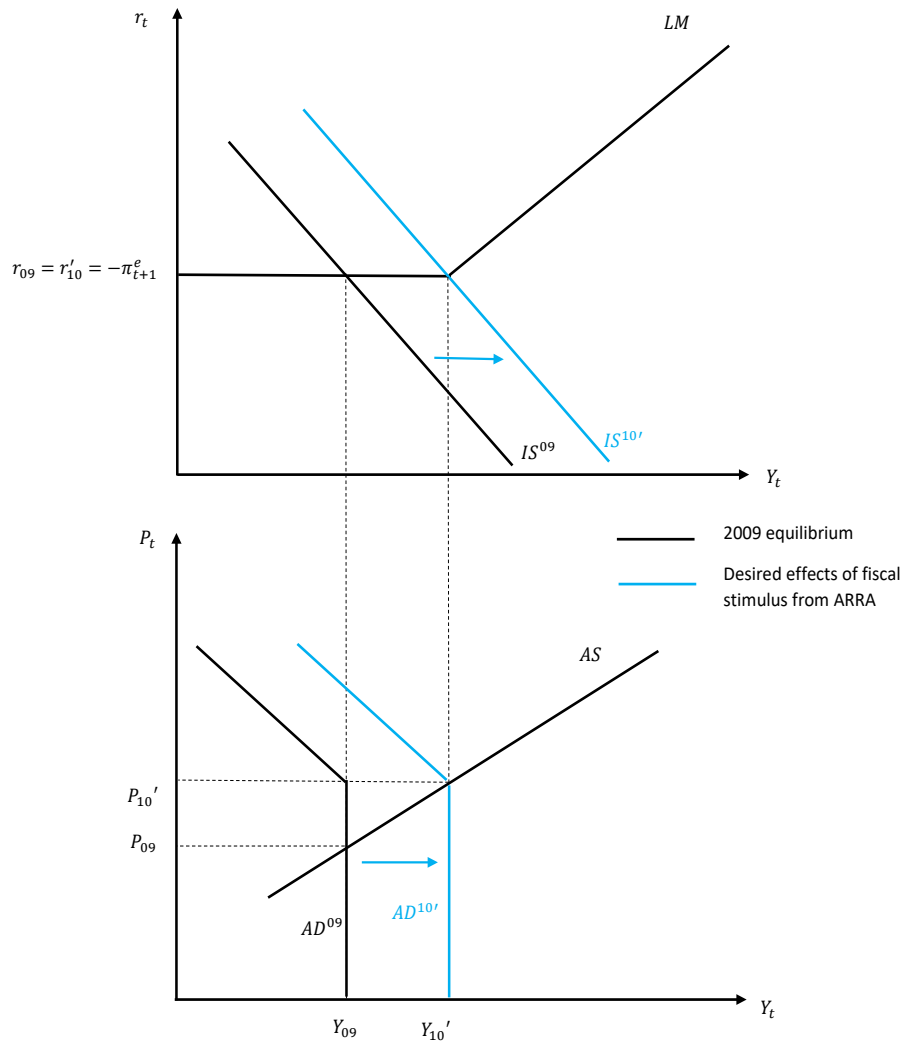

Figure 36.19 shows the desired effects of the fiscal stimulus in the AD-AS model. The increase in government spending (or more broadly the combined effects of the increase in spending and tax cuts to the extent to which Ricardian Equivalence does not hold) cause the IS curve to shift to the right. The stimulative effect on the AD curve is larger than it would be if the ZLB does not bind. The empirical evidence on the economic consequences of fiscal policy in general, and the ARRA in particular, is quite mixed, with no clear answers emerging. It is thus somewhat difficult to say whether or not the ARRA worked as intended. For example, [Conley and Dupor \(2013\)](#) argue that the ARRA did little more than create government jobs at the expense of private jobs. [Chodorow-Riech, Feivson, Liscow, and Woolston \(2012\)](#) and [Wilson \(2012\)](#) offer more positive takes on the stimulative effects of the ARRA. A survey of economists from the University of Chicago's [IGM Forum](#) indicates that more than 80 percent of surveyed economists felt that the economy was better at the end of

2010 than it would have been without the stimulus package.

Another aspect of the government's fiscal intervention in the wake of the Great Recession was the Troubled Asset Relief Program (TARP). Although the TARP shared some similarities with extraordinary Federal Reserve lending and it was conducted in consultation with the Fed, it was a program by the Treasury and is thus best classified as a fiscal program. The basic idea of TARP was for the Treasury to purchase "troubled assets" (like mortgage backed securities and collateralized debt obligations) from the nation's biggest banks. The basic idea of this program is fairly simple. The crisis occurred because concerns about the valuation of assets on financial institutions balance sheets led to a run in which short term funding for these firms dried up. This run required institutions to try to sell these assets, which further depressed the price of these assets and intensified the run. The idea was that the government could come in and buy the questionable assets. This would give these institutions needed liquidity and would hopefully help to stem the run. In exchange, the Treasury received equity shares in the banks receiving funds. The economic consequences of TARP remain hotly debated and few concrete observations have emerged concerning its effectiveness (or lack thereof).

36.4.3 Unconventional Monetary Policy

Conventional monetary policy involves adjusting the money supply and short term interest rates so as to stabilize the economy about its potential. This was of course the first line of defense in response to the Great Recession – the Fed aggressively lowered its key policy rate all the way to zero by the end of 2008. Even with this, along with the extraordinary lending activities undertaken by the Fed which are documented above, the Fed felt that this was not enough and that the economy needed more stimulus.

Once the Federal Funds rate had hit its zero lower bound in late 2008, the Fed began to experiment with several different forms of unconventional monetary policies. To implement conventional monetary policy, the Fed buys and sells primarily short term government debt (i.e. Treasury bills). By affecting the amount of this debt in circulation the Fed can manipulate very short term interbank lending rates. Interbank lending rates (e.g. the Federal Funds rate) are not directly relevant for households or firms in making spending and investment decisions. The credit households and firms receive is typically risk adjusted (i.e. Baa corporate bond rates have a higher perceived default risk than government bonds) and longer term (i.e. a 10 year maturity as opposed to overnight). But interest rates relevant for these actors are nevertheless affected by short term interbank lending rates because debt instruments with different risk and maturity characteristics are nevertheless to some degree substitutes. This

means that if the Fed Funds rate goes up or down by a certain amount, we would expect other interest rates in the economy to move in a similar direction. See also the more detailed discussion in Chapter 33. In the context of our model, we would think about conventional monetary policy as affecting r_t but not f_t (the credit spread) – hence the rate relevant for investment decisions, $r_t + f_t$, moves in the same way as r_t for a fixed f_t .

With the zero lower bound binding, it was not possible to use conventional monetary policy to stimulate the economy – i.e. i_t , and hence r_t , could not be lowered any further, so this means was not available to impact $r_t + f_t$. Purchases of short term Treasuries would do nothing to impact interbank lending rates given that the banking system was generally in a state of hoarding cash. The Fed instead had to think outside of the box. The Fed resorted to unconventional policies, which we group into two parts: *quantitative easing* and *forward guidance*. Quantitative easing involves purchases of longer term and/or riskier debt, with the objective to push up the price of these assets and the associated yields (interest rates) down. Forward guidance involves communicating to the public the expected *future* path of short term interest rates.

To discuss quantitative easing and forward guidance intelligently we must take a brief step back and think a bit about the *risk* and *term structure* of interest rates. More detail is provided in Chapter 33. In reality there are many different interest rates in an economy – e.g. the Fed Funds rate, the 3 month Treasury Bill rate, the 10 year Treasury note, a 30 year Treasury bond rate, a 15 year mortgage rate, a 30 year mortgage rate, the Aaa corporate bond rate, the Baa corporate bond rate, etc. These rates differ both according to perceived risk (i.e. a Aaa rated corporate bond is perceived as being less risky than Baa rated bonds, and interest rates are typically higher the greater is perceived risk of default) and time to maturity (i.e. the 10 year Treasury versus a 3 month Treasury Bill; for the most part, interest rates are higher the longer the time to maturity, i.e. yield curves slope up). Most macroeconomic models, including those models presented in this book, abstract from this complexity and focus on one or at most two interest rates. In terms of the models studied in this book, the short term, riskless real interest rate is r_t , while the (real) interest rate relevant for investment decisions is $r_t + f_t$. We can think about the first interest rate as being something the Fed can manipulate, while the second is a stand-in for the risk and term structure of interest rates.

For debt instruments, bond price and yield (an alternative name for interest rate) move opposite one another. This is easiest to see for a so-called discount bond. A discount bond promises the holder of the bond some pre-specified payment at some point in the future (say, for simplicity, one period into the future) called the face value. The bond sells at a price lower than the face value. The percentage difference between the bond price and the face value is the implied interest rate (or yield). In particular, we could think of $P_t^B = \frac{1}{1+i_{B,t}} FV$ as

relating the price of the bond, its interest rate, and its face value. For example, if I buy a \$100 face value bond for \$90, and the bond matures (i.e. pays the face value) in one year, then the implicit interest rate on the bond is 11 percent. Although payment details differ for different kinds of bonds, the basic idea that the interest rate (yield) and price move opposite one another always holds.

What is the connection between all the different kinds of interest rates in the world? There are two polar extreme theories, with reality likely lying somewhere in between. The first theory is called *segmented markets*, and is based on the idea that debt instruments with different risk and/or maturity characteristics are not substitutable at all. Under segmented markets, we can think about there being separate demand-supply diagrams for bonds with different characteristics. Demand and supply determine price and interest rates for each type of bond, and there are no spillover effects between markets for different types of debt. Figure 36.20 plots a hypothetical demand-supply diagram for a particular kind of bond. Demand for the bond is downward-sloping. Demand comes from savers who want to hold the bond to earn interest – the lower the bond price, the higher the interest rate, and the more of the bond savers would want to hold. Supply is upward-sloping. Bond supply comes from debtors who want to borrow funds. The higher is the price, the lower is the interest rate, and hence the more funds these debtors would like to borrow. Demand and supply intersect to determine an equilibrium quantity and price.

Figure 36.20: Demand and Supply for a Bond, Segmented Markets

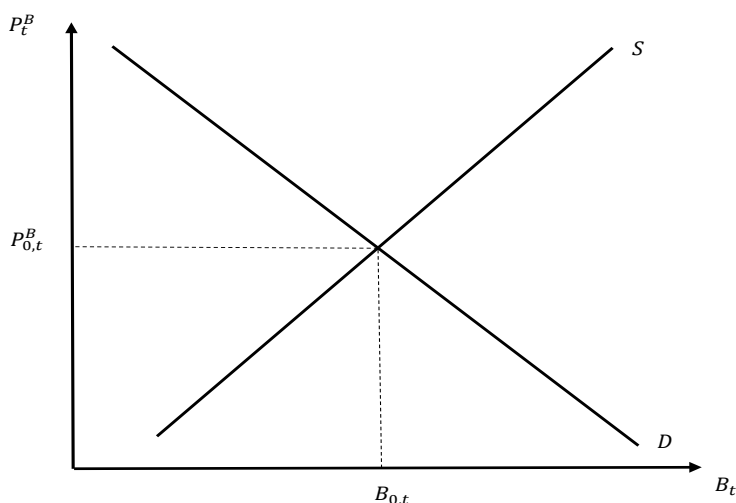

The basic idea behind the Fed’s various rounds of quantitative easing was for the Fed to purchase large quantities of mortgage related debt securities and/or longer maturity Treasury

securities.¹ The Fed would create base money by creating reserves to purchase these securities from private banks. Quantitative easing (or QE, for short) proceeded in three distinct waves. The first wave, or what was called QE1 after the fact, was announced in November of 2008. At first this involved only purchases of mortgage backed securities, but as the program continued the Fed also purchased longer maturity Treasury securities. This program continued through the summer of 2010. At its peak the Fed held some \$2 trillion dollars in mortgage backed securities and longer term Treasuries. Figure 36.21 plots the evolution of the Fed’s holdings of mortgage backed securities and longer term Treasury securities.² Prior to the crisis, the Fed held none of these securities.

Figure 36.21: Unconventional Asset Holdings by Fed

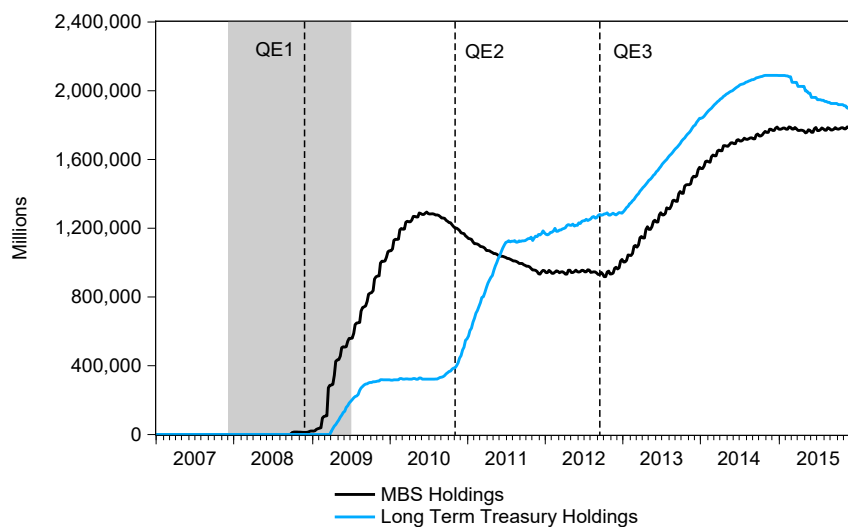

The second round of quantitative easing, or QE2, was announced in November of 2010. QE2 focused on purchasing longer maturity Treasury securities. The uptick in the Fed’s holding of these securities can be clearly seen in Figure 36.21. The third round of quantitative easing, or QE3, began in November of 2012 and focused mostly on purchasing more mortgage backed securities. The effects of this program on the Fed’s holdings of these securities can clearly be seen in the Figure. Quantitative easing programs formally ceased (i.e. the Fed ceased buying new securities) towards the end of 2014. By the end, the Fed had purchased close to \$4 trillion in longer maturity Treasury and mortgage backed securities.

The objective of the quantitative easing programs was to increase the market prices of the debt instruments the Fed was buying. By doing so, this would result in lower interest

¹The Fed’s purchases of mortgage backed securities was restricted to securities issued by the government sponsored enterprises Fannie Mae, Freddie Mac, and Ginnie Mae. For this reason, one sometimes sees the term *agency backed securities* (ABS) when referring to the Fed’s asset purchases.

²These data are available for download from the [Federal Reserve Bank of Cleveland](#).

rates, which would hopefully be passed on to consumers and businesses in the form of lower interest rates on mortgage loans, business loans, and the like. This is easy to see using the demand-supply analysis from Figure 36.20. The QE programs involved a large increase in the demand for these types of debt. The increase in demand ought to increase the price of this debt and lower the interest rate, as shown in Figure 36.22.

Figure 36.22: Desired Effects of Quantitative Easing Programs

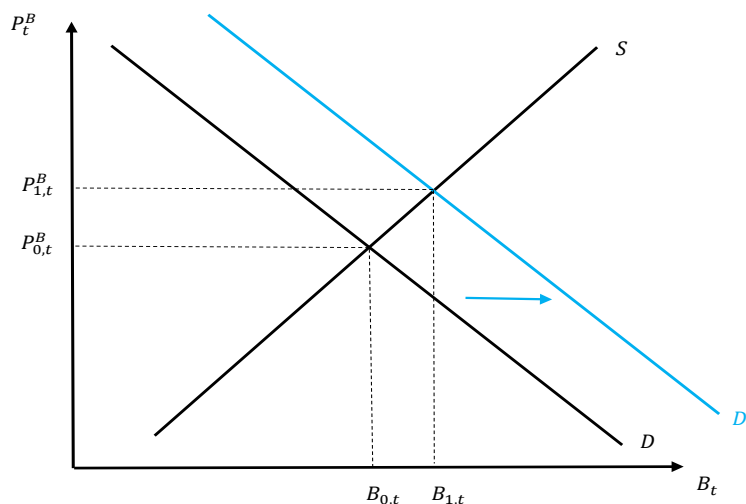

Former Fed chairman Ben Bernanke once famously quipped that “quantitative easing works in practice but not in theory.” In essence he was referring to the alternative theory of the term structure of interest rates called the *expectations hypothesis*. In this theory, bonds of different maturities are perfect substitutes. This ends up meaning that the interest rate on a long maturity bond is approximately equal to the *average* of expected short term interest rates. Formally, if a bond has a N period maturity, then the interest rate on that bond should equal the average of expected interest rates on one periods maturity bonds, plus a term premium to account for the fact that longer maturity bonds carry more risk in the event they need to be sold before maturity:

$$i_{N,t} = \frac{1}{N} (i_{1,t} + i_{1,t+1}^e + \dots + i_{1,t+N-1}^e) + tp_t \quad (36.1)$$

In (36.1), $i_{N,t}$ is the interest rate on a N maturity bond observed at time t , $i_{1,t}$ is the interest rate on a 1 maturity bond observed at time t , $i_{1,t+1}^e$ is the expected interest rate on a one maturity bond one period into the future, and so on. tp_t is a term premium that accounts for the risk involved in holding longer maturity bonds. See also the discussion in Chapter 33.

For example, suppose that you are considering a Treasury security with a one year maturity. If the current interest rate on a Treasury security with a three month maturity

is 4 percent, and the expected interest rates on three month maturity Treasury securities for the ensuing three quarters are 5, 6, and 7 percent, then the interest rate on the one year Treasury security ought to be 5.5 percent (i.e. $\frac{1}{4}(4 + 5 + 6 + 7)$) plus a term premium to account for risk. The basic intuition behind the expectations hypothesis is straightforward. If you are looking to save and transfer resources across a long period of time, you can either buy a long maturity bond or a sequence of shorter maturity bonds. If your only objective is to transfer resources intertemporally, then you ought to be indifferent between these two options once you adjust for different levels of risk (i.e. add in a term premium). This ends up necessitating that the interest rate on the long maturity bond approximately equals the average of expected short maturity interest rates plus a term premium.

Using similar theoretical considerations, we can think about yields on long maturity, risky, private sector debt (e.g. corporate bonds) as being related to yields on long term government bonds, plus a risk premium to compensate for default risk. Let $i_{N,t}^r$ denote the yield on risky private sector debt with N periods to maturity. It ought to equal:

$$i_{N,t}^r = i_{N,t} + rp_t \tag{36.2}$$

In (36.2), rp_t is a risk premium to compensate holders of such debt for default risk. (36.1) and (36.2) embody the idea that bond with different characteristics are *perfect substitutes* once one controls for risk. As discussed in Chapter 33, the risk and term premia relate to how bond prices co-vary with the marginal utility of consumption, and it is not clear how or why quantitative easing could influence these terms. If this is the case, the only way for a central bank to influence $i_{N,t}^r$ is to influence $i_{N,t}$, and the way to influence $i_{N,t}$ is to affect the current and expected future path of short term riskless yields. Since quantitative easing does not impact the current or expected future path of short term yields, it is not clear why it (in either form of purchasing long term government debt or risky private sector debt) should impact $i_{N,t}^r$.

For these reasons, the analysis portrayed graphically in Figure 36.22 might be too simple. In particular, if long term and risky bonds are perfectly substitutable with short term riskless bonds (once one controls for risk), the demand for such bonds ought to be perfectly elastic (i.e. horizontal), and large-scale purchases of such bonds ought not to impact their prices or yields. The Fed purchasing such debt would temporarily increase the demand for such debt, driving prices up and yields down. But if long term and risky debt are perfectly substitutable with short term riskless debt (once one controls for risk), this would cause private sector demand to shift way from these securities and into shorter term, riskless debt until yields are equalized.

Based on the logic of the expectations hypothesis, in addition to its quantitative easing

programs the Fed also resorted to another form of unconventional monetary policy, what is called *forward guidance*. Whereas quantitative easing will be ineffective under the expectations hypothesis, forward guidance relies on the expectations hypothesis characterizing reality. Under forward guidance, the Fed tries to communicate to the private sector its intended path of short term interest rates, particularly the path after the period where the ZLB binds is over. For example, suppose that the current and expected future short term interest rates are both at 0, but expected short term interest rates in the two periods after that are 1 and 2 percent, respectively. Under the expectations hypothesis, the current interest rate on a four period maturity debt instrument ought to be 0.75 percent (i.e. $\frac{1}{4}(0 + 0 + 1 + 2)$) (plus a term premium). If the Fed can convince the private sector that it will lower the short term interest rates to 0 and 1 percent three and four periods out into the future, respectively, then it could, in principle, lower the current four period interest rate to 0.25 percent (i.e. $\frac{1}{4}(0 + 0 + 0 + 1)$) (plus a term premium which would be unaffected). Lower long term rates would filter through to yields on risky private sector debt, as in (36.2).

The Fed began using forward guidance at the same time it started quantitative easing. In December 2008, for example, the Fed issued a press release stating that “The Committee anticipates that weak economic conditions are likely to warrant exceptionally low levels of the Federal Funds rate for some time.” In March 2009, the Fed changed language from “some time” to “an extended period.” In subsequent meetings the Fed gave specificity to how long it anticipated the Fed Funds rate being low – for example, in January of 2012 the Fed said that it anticipated it would remain low until “late 2014.”³ In a sense, the Fed was hedging its bets. It wanted to lower interest rates on risky and longer term debt. It tried both quantitative easing and forward guidance to do so, both of which should not be able to work at the same time. Nevertheless, the evidence suggests that both the Fed’s QE programs and its forward guidance attempts did work to lower longer term, riskier interest rates (see, e.g. [Campbell, Evans, Fisher, and Justiniano 2012](#) for evidence on forward guidance and [Krishnamurthy and Vissing-Jorgensen \(2011\)](#) for the effects of quantitative easing).

In terms of the AD-AS model, we can think about the unconventional monetary policies of quantitative easing and forward guidance as both having the same objective – lowering credit spreads, f_t . In this sense, these policies were designed to work similarly to the Fed’s extraordinary lending policies. The objective was to lower f_t , and hence the relevant interest rate for investment spending, without adjusting the short term Federal Funds Rate. If successful, the decrease in f_t would shift the IS curve to the right with a resulting rightward shift of the AD curve. The desired effects of these interventions are shown in Figure 36.23

³The wording in this paragraph follows the first paragraph in [Campbell, Evans, Fisher, and Justiniano \(2012\)](#).

below. We label the hypothetical new curves with lower f_t as being dated in 2012, because this was the last period in which a new quantitative easing program was announced.

Figure 36.23: AD-AS Effects of Federal Reserve Quantitative Easing and Forward Guidance

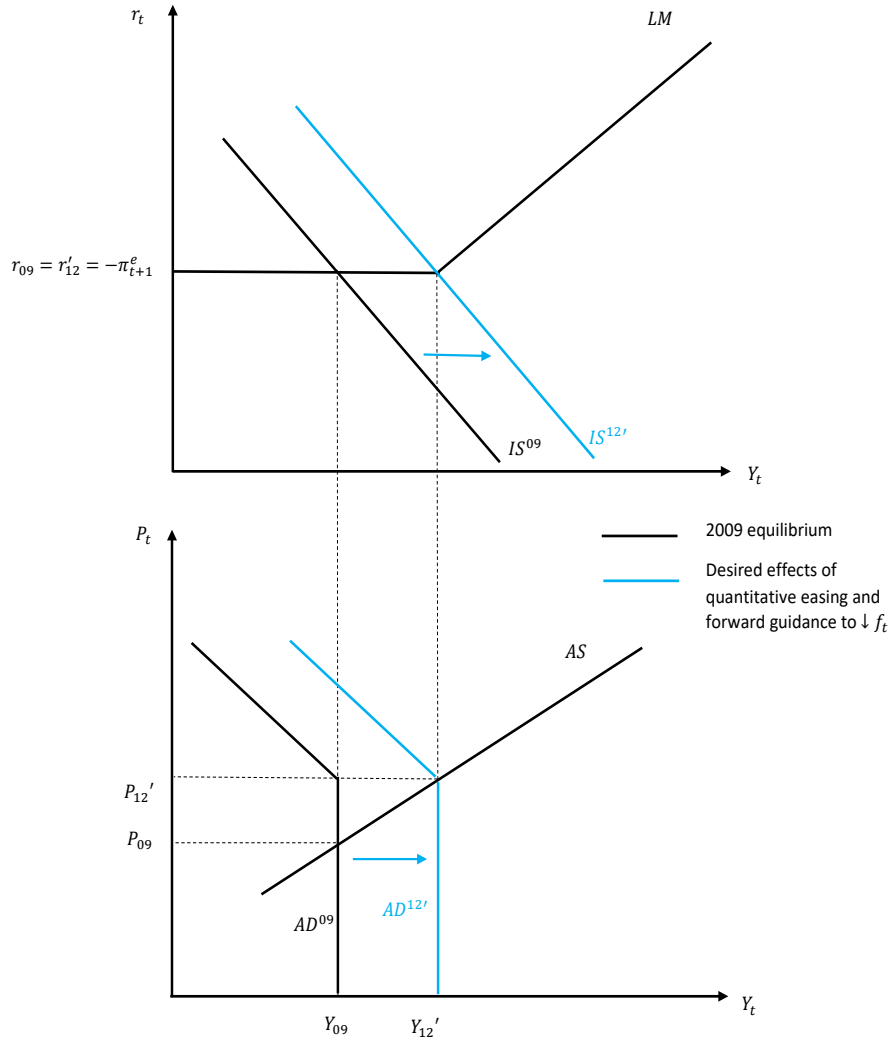

36.5 Lingering Questions

The Great Depression was a formative experience for the generation of economists that lived through it and shaped macroeconomic thought and policy for decades. In a similar way, the Great Recession has been a formative experience for macroeconomists in the last decade. Among other things, the Great Recession has emphasized the importance of linkages between the financial system and the macroeconomy. Prior to the crisis, most macroeconomics textbooks abstracted from things like credit spreads altogether. The Great Recession has forced us to reconsider this and other aspects of economists' modeling frameworks.

The Great Recession has also spurred a whole new set of questions on which macroeconomists now focus. Why and how did house prices get so high in the first place, and why did they come crashing down starting in 2006? What is the appropriate level of regulation of financial institutions, and should this regulation extend beyond traditional banks? What is the appropriate level of government intervention in response to crises? Does the implicit promise of being bailed out incentivize excessive risk-taking behavior? Why has the economic recovery from the crisis been relatively weak – i.e. why has real GDP not returned to a pre-recession trend (see, e.g., Figure 36.16)? What have been the effects of the Fed’s unconventional monetary policy actions? In the years since the crisis, why has inflation been persistently below where the Fed would like it to be (2 percent) in spite of all the Fed’s actions? What are the downward pressures on interest rates throughout the world, and what are the implications for monetary policy going forward?

We close this chapter by noting that these questions are not likely to go away anytime soon. Getting compelling answers to important macroeconomic questions is always difficult. To ascertain what the effects of different policies are, we need to know what would have happened in historical episodes in the absence of those policies. This counterfactual history is never (or at least rarely) observed, so we are forced to rely upon simplified modeling frameworks to arrive at answers, and the answers these models give us always depend on the underlying assumptions in the models. Sooner rather than later, the economy is likely to experience another cyclical downturn. With short term interest rates still at very low levels, what room will the Fed and other central banks around the world have to maneuver? Will unconventional monetary policies like forward guidance and quantitative easing be the main lines of defense against recessions in the future? Only time will tell. It is an exciting time to study macroeconomics!

36.6 Summary

- The tell-tale sign of a financial crisis is sharp increase in credit spreads
- Financial crises are typically preceded by asset price booms and then busts. In the Great Depression, it was a general stock market boom that ended in 1929 and set off the Depression. In the Great Recession, it was a boom in housing prices that ended in 2006.
- Following asset price booms and busts there is typically a “run” on financial intermediaries as investors become worried about the value of the investments a financial institution holds. In the Great Depression, this run was a run on deposits by house-

holds against traditional banks. In the Great Recession, the run was somewhat more complicated. It involved institutions running on other institutions, with short term credit markets drying up and institutions being forced to liquidate assets.

- In the terms of the AD-AS model, we can think about the Great Recession as featuring several adverse shocks to the IS curve. The first was a direct effect of home price declines and was not large. The second was due to an increase in credit spreads in 2007 and into 2008. The Fed responded to both of these shocks by aggressively lowering interest rates, which meant that by the end of 2008 the Federal Funds rate was at its zero lower bound (ZLB).
- The Great Recession entered its most virulent stage at the end of 2008 and into the first half of 2009 when the financial crisis intensified. The macroeconomic effects of the negative IS shock were exacerbated by the binding ZLB.
- There were many unconventional policy actions taken to combat the Great Recession. This differs somewhat from the Great Depression, where many economists feel that the Fed let things get out of hand and should have done a better job as a lender of last resort. These unconventional policy actions included emergency Federal Reserve lending to financial institutions, fiscal stimulus, and unconventional monetary policies in the form of quantitative easing and forward guidance.

Bibliography

- Abel, Andrew, Ben Bernanke, and Dean Croushore. 2017. *Macroeconomics, 9th Edition*. Pearson.
- Acemoglu, Daron, Simon Johnson, and James A. Robinson. 2001. “The Colonial Origins of Comparative Development: An Empirical Investigation.” *American Economic Review* 91 (5):1369–1401. URL <http://www.aeaweb.org/articles?id=10.1257/aer.91.5.1369>.
- Aguiar, Mark and Erik Hurst. 2005. “Consumption vs. Expenditure.” *Journal of Political Economy* 113 (5):919–948.
- Akerlof, George. 1970. “The Market for ‘Lemons’: Quality Uncertainty and the Market Mechanism.” *Quarterly Journal of Economics* 84(3):488–500.
- Ando, Albert and Franco Modigliani. 1963. “The ‘Life Cycle’ Hypothesis of Saving: Aggregate Implications and Tests.” *The American Economic Review* 53 (1):55–84. URL <http://www.jstor.org/stable/1817129>.
- Ball, Laurence and N. Gregory Mankiw. 2011. *Macroeconomics and the Financial System*. Worth.
- Barattieri, Alessandro, Susanto Basu, and Peter Gottschalk. 2014. “Some Evidence on the Importance of Sticky Wages.” *American Economic Journal: Macroeconomics* 6 (1):70–101.
- Barro, Robert J. 1974. “Are Government Bonds Net Wealth?” *Journal of Political Economy* 82 (6):1095–1117.
- . 1979. “On the Determination of the Public Debt.” *Journal of Political Economy* 87 (5):940–971.
- . 1997. *Macroeconomics, 5th Edition*. MIT Press.
- Basu, Susant, John G. Fernald, and Miles S. Kimball. 2006. “Are Technology Improvements Contractionary?” *American Economic Review* 96 (5):1418–1448. URL <http://ideas.repec.org/a/mcb/jmoncb/v29y1997i3p314-25.html>.

- Baxter, Marianne and Robert G King. 1993. "Fiscal Policy in General Equilibrium." *American Economic Review* 83 (3):315–34. URL <https://ideas.repec.org/a/aea/aecrev/v83y1993i3p315-34.html>.
- Bernanke, Ben S., Mark Gertler, and Simon Gilchrist. 1999. "The financial accelerator in a quantitative business cycle framework." In *Handbook of Macroeconomics, Handbook of Macroeconomics*, vol. 1, edited by J. B. Taylor and M. Woodford, chap. 21. Elsevier, 1341–1393. URL <https://ideas.repec.org/h/eee/macchp/1-21.html>.
- Bils, Mark and Peter Klenow. 2004. "Some Evidence on the Importance of Sticky Prices." *Journal of Political Economy* 112 (5):947–985.
- Blanchard, Olivier. 2017. *Macroeconomics, 7th Edition*. Pearson.
- Blanchard, Olivier and Jordi Galí. 2007. "Real Wage Rigidities and the New Keynesian Model." *Journal of Money, Credit, and Banking* 39(1):35–65.
- Brock, William and Leonard Mirman. 1972. "Optimal economic growth and uncertainty: The discounted case." *Journal of Economic Theory* 4 (3):479–513. URL <http://EconPapers.repec.org/RePEc:eee:jetheo:v:4:y:1972:i:3:p:479-513>.
- Campbell, Jeffrey, Charles L. Evans, Jonas Fisher, and Alejandro Justiniano. 2012. "Macroeconomic Effects of Federal Reserve Forward Guidance." *Brookings Papers on Economic Activity* 43 (1 (Spring)):1–80. URL <https://EconPapers.repec.org/RePEc:bin:bpeajo:v:43:y:2012:i:2012-01:p:1-80>.
- Cass, David. 1965. "Optimum Growth in an Aggregative Model of Capital Accumulation." *The Review of Economic Studies* 32 (3):233–240. URL <http://www.jstor.org/stable/2295827>.
- Chodorow-Riech, Gabriel, Laur Feivson, Zachary Liscow, and William Gui Woolston. 2012. "Does State Fiscal Relief During Recessions Increase Employment? Evidence from the American Recovery and Reinvestment Act." *American Economic Journal: Economic Policy* 4(3):118–145.
- Christiano, Lawrence, Martin Eichenbaum, and Charles Evans. 1999. "Monetary Policy Shocks: What Have We Learned and to What End?" In *Handbook of Macroeconomics*, edited by John Taylor and Michael Woodford. 16–34.
- Christiano, Lawrence, Martin Eichenbaum, and Sergio Rebelo. 2011. "When Is the Government Spending Multiplier Large?" *Journal of Political Economy* 119 (1):78–121. URL <https://ideas.repec.org/a/ucp/jpolec/doi10.1086-659312.html>.

- Chugh, Sanjay K. 2015. *Modern Macroeconomics*. MIT Press.
- Coibion, Olivier and Yuriy Gorodnichenko. 2015. “Is the Phillips Curve Alive and Well After All? Inflation Expectations and the Missing Disinflation.” *American Economic Journal: Macroeconomics* 7 (1):197–232.
- Coibion, Olivier, Yuriy Gorodnichenko, and Johannes Wieland. 2012. “The Optimal Inflation Rate in New Keynesian Models: Should Central Banks Raise Their Inflation Targets in Light of the Zero Lower Bound?” *Review of Economic Studies* 79:1371–1406.
- Conley, Timothy G. and Bill Dupor. 2013. “The American Recovery and Reinvestment Act: Solely a Government Jobs Program?” *Journal of Monetary Economics* 60(5):535–549.
- Cubas, German, B. Ravikumar, and Gustavo Ventura. 2016. “Talent, labor quality, and economic development.” *Review of Economic Dynamics* 21:160 – 181. URL <http://www.sciencedirect.com/science/article/pii/S109420251500040X>.
- Delong, Bradford. 1998. “Estimating World GDP, One Million BC-Present.” Working Paper, University of California at Berkeley 2012-19. URL http://delong.typepad.com/print/20061012_LRWGDP.pdf.
- Diamond, Douglas W. 2007. “Banks and Liquidity Creation: A Simple Exposition of the Diamond-Dybvig Model.” *Federal Reserve Bank of Richmond Economic Quarterly* 93(2):189–200.
- Diamond, Douglas W. and Philip H. Dybvig. 1983. “Bank Runs, Deposit Insurance, and Liquidity.” *Journal of Political Economy* 91(5):401–419.
- Diamond, Peter A. 1965. “National Debt in a Neoclassical Growth Model.” *American Economic Review* 55:1126–1150.
- . 1982. “Wage Determination and Efficiency in Search Equilibrium.” *Review of Economic Studies* 49 (2):217–227.
- Doleac, Jennifer L. and Benjamin Hansen. 2016. “Does ‘Ban the Box’ Help or Hurt Low-Skilled Workers? Statistical Discrimination and Employment Outcomes when Criminal Histories are Hidden.” NBER working paper 22469.
- Dornbusch, Rudiger, Stanley Fischer, and Richard Startz. 2013. *Macroeconomics, 12th Edition*. McGraw Hill.

- Evans, William N. and Timothy J. Moore. 2012. "Liquidity, Activity, and Mortality." *Review of Economics and Statistics* 94 (2):400–418.
- Friedman, Milton. 1968. "The Role of Monetary Policy." *American Economic Review* 58 (1):1–17.
- Friedman, Milton and Anna J. Schwartz. 1971. *A Monetary History of the United States*. Princeton University Press.
- Froyen, Richard T. 2013. *Macroeconomics, Theories and Policies, 10th Edition*. Pearson.
- Gordon, Robert J. 2012. *Macroeconomics, 12th Edition*. Pearson.
- . 2016. *The Rise and Fall of American Growth: the US Standard of Living Since the Civil War*. Princeton University Press.
- Gorton, Gary B. 2010a. "Questions and Answers About the Financial Crisis." NBER working paper 15787.
- . 2010b. *Slapped by the Invisible Hand: The Panic of 2007*. Oxford University Press.
- . 2012. *Misunderstanding Financial Crises: Why We Don't See Them Coming*. Oxford University Press.
- . 2015. *The Maze of Banking*. Oxford University Press.
- Greenwood, Jeremy, Zvi Hercowitz, and Gregory Huffman. 1988. "Investment, Capacity Utilization, and the Real Business Cycle." *American Economic Review* 78 (3):402–417. URL https://www.jstor.org/stable/1809141?seq=1#page_scan_tab_contents.
- Greenwood, Jeremy, Zvi Hercowitz, and Per Krusell. 2000. "The role of investment-specific technological change in the business cycle." *European Economic Review* 44 (1):91–115. URL <https://ideas.repec.org/a/eee/eecrev/v44y2000i1p91-115.html>.
- Hall, Robert E. 1978. "Stochastic Implications of the Life Cycle-Permanent Income Hypothesis: Theory and Evidence." *Journal of Political Economy* 86 (6):971–987.
- Hall, Robert E. and David H. Pappell. 2005. *Macroeconomics, 6th Edition*. WW Norton.
- Hicks, J. R. 1937. "Mr. Keynes and the "Classics"; A Suggested Interpretation." *Econometrica* 5 (2):147–159. URL <http://www.jstor.org/stable/1907242>.
- Jones, Charles I. 2013. *Macroeconomics, 3rd Edition*. WW Norton.

- Kaldor, Nicholas. 1957. "A Model of Economic Growth." *The Economic Journal* 67 (268):591–624. URL <http://www.jstor.org/stable/2227704>.
- Klein, Lawrence R. and Arthur S. Goldberger. 1955. *An Econometric Model for the United States, 1929-1952*. Amsterdam: North-Holland.
- Koopmans, Tjalling C. 1963. "On the Concept of Optimal Economic Growth." Cowles Foundation Discussion Papers 163, Cowles Foundation for Research in Economics, Yale University. URL <https://ideas.repec.org/p/cwl/cwldpp/163.html>.
- Krishnamurthy, Arvind and Annette Vissing-Jorgensen. 2011. "The Effects of Quantitative Easing on Interest Rates: Channels and Implications for Policy." 43.
- Kydland, Finn E and Edward C Prescott. 1977. "Rules Rather Than Discretion: The Inconsistency of Optimal Plans." *Journal of Political Economy* 85 (3):473–91. URL <https://ideas.repec.org/a/ucp/jpolec/v85y1977i3p473-91.html>.
- Kydland, Finn E. and Edward C. Prescott. 1982. "Time to Build and Aggregate Fluctuations." *Econometrica* 50 (6):1345–1370. URL <http://www.jstor.org/stable/1913386>.
- Lucas, Robert E. 1972. "Expectations and the Neutrality of Money." *Journal of Economic Theory* 4 (2):103–124.
- . 1978. "Asset Prices in an Exchange Economy." *Econometrica* 46 (6):1429–1445.
- Lucas, Robert E. and Thomas J. Sargent. 1979. "After Keynesian macroeconomics." *Quarterly Review* (Spr). URL <https://ideas.repec.org/a/fip/fedmqr/y1979isprnv.3no.2.html>.
- Lucas, Robert Jr. 1976. "Econometric policy evaluation: A critique." *Carnegie-Rochester Conference Series on Public Policy* 1 (1):19–46. URL <https://ideas.repec.org/a/eee/crcspp/v1y1976ip19-46.html>.
- Mankiw, N Gregory. 1990. "A Quick Refresher Course in Macroeconomics." *Journal of Economic Literature* 28 (4):1645–60. URL <https://ideas.repec.org/a/aea/jeclit/v28y1990i4p1645-60.html>.
- Mankiw, N. Gregory. 2016. *Macroeconomics, 9th Edition*. Macmillan.
- Mankiw, N. Gregory, David Romer, and David N. Weil. 1992. "A Contribution to the Empirics of Economic Growth." *The Quarterly Journal of Economics* 107 (2):407–437. URL <http://qje.oxfordjournals.org/content/107/2/407.abstract>.

- Mathworld. 2016. "Euler's homogeneous function theorem." *Mathworld* URL <http://mathworld.wolfram.com/EulersHomogeneousFunctionTheorem.html>.
- McGrattan, Ellen R, Richard Rogerson, and Randall Wright. 1997. "An Equilibrium Model of the Business Cycle with Household Production and Fiscal Policy." *International Economic Review* 38 (2):267–90. URL <https://ideas.repec.org/a/ier/iecrev/v38y1997i2p267-90.html>.
- Mishkin, Frederic. 2016. *The Economics of Money, Banking, and Financial Markets, 11th Edition*. Pearson.
- Mishkin, Frederic S. 2011. "Over the Cliff: From the Subprime to the Global Financial Crisis." *Journal of Economic Perspectives* 25 (1):49–70.
- Modigliani, Franco and Merton Miller. 1958. "The Cost of Capital, Corporation Finance and the Theory of Investment." *American Economic Review* 48 (3):261–297.
- Parker, Jonathan A. 1999. "The Reaction of Household Consumption to Predictable Changes in Social Security Taxes." *American Economic Review* 89 (4):959–973.
- Phelps, Edmund. 1967. "Phillips Curves, Expectations of Inflation and Optimal Employment over Time." *Economica* 34 (3):254–281.
- Phillips, A.W.H. 1958. "The Relation Between Unemployment and the Rate of Change of Money Wage Rates in the United Kingdom, 1861-1957." *Economica* 25 (2):283–289.
- Pissarides, Christopher and Dale Mortenson. 1994. "Job Creation and Job Destruction in the Theory of Unemployment." *Review of Economic Studies* 61 (3):397–415.
- Pissarides, Christopher A. 1985. "Wage Determination and Efficiency in Search Equilibrium." *American Economic Review* 75 (4):676–690.
- Robert E. Lucas, Jr. 1971. "Optimal Management of a Research and Development Project." *Management Science* 17 (11):679–697. URL <https://ideas.repec.org/a/inm/ormnsc/v17y1971i11p679-697.html>.
- Sachs, Jeffrey D. and Andrew Warner. 1995. "Economic Reform and the Process of Global Integration." *Brookings Papers on Economic Activity* 26 (1, 25th A):1–118. URL <https://ideas.repec.org/a/bin/bpeajo/v26y1995i1995-1p1-118.html>.
- Samuelson, Paul A. 1958. "An Exact Consumption-Loan Model of Interest with or without the Social Contrivance of Money." *Journal of Political Economy* 66:467–482.

- Sargent, Thomas J. and Neil Wallace. 1975. ““Rational” Expectations, the Optimal Monetary Instrument, and the Optimal Money Supply Rule.” *Journal of Political Economy* 83 (2):241–254. URL <http://www.jstor.org/stable/1830921>.
- Shapiro, Matthew D. and Joel Slemrod. 2003. “Consumption Response to Tax Rebates.” *American Economic Review* 93 (1):381–396.
- . 2009. “Did the 2008 Tax Rebates Stimulate Spending?” *American Economic Review* 99 (2):374–379.
- Solon, Gary, Robert Barsky, and Jonathan Parker. 1994. “Measuring the Cyclicalities of Real Wages: How Important is Composition Bias?” *Quarterly Journal of Economics* 109 (1):1–25.
- Solow, Robert M. 1956. “A Contribution to the Theory of Economic Growth.” *Quarterly Journal of Economics* 70 (1):65–94.
- Summers, Lawrence. 1986. “Some Skeptical Observations on Real Business Cycle Theory.” *Federal Reserve Bank of Minneapolis Quarterly Review* Fall:23–27.
- Taylor, John. 1993. “Discretion versus Policy Rules in Practice.” *Carnegie-Rochester Conference Series on Public Policy* 39:195–214.
- Tobin, J. 1958. “Liquidity Preference as Behavior Towards Risk.” *Review of Economic Studies* 25 (2):65–86. URL <https://ideas.repec.org/a/oup/restud/v25y1958i2p65-86.html>.
- Wicksell, Knut. 1898. *Interest and Prices*.
- Williamson, Stephen D. 2014. *Macroeconomics, 5th Edition*. Pearson.
- Wilson, Daniel J. 2012. “Fiscal Spending Jobs Multipliers: Evidence from the 2009 American Recovery and Reinvestment Act.” *American Economic Journal: Economic Policy* 4(3):251–282.
- Woodford, Michael. 2003. *Interest and Prices: Foundations of a Theory of Monetary Policy*.

List of Figures

1.1	Logarithm of Nominal GDP	27
1.2	GDP Components as a Share of Total GDP	28
1.3	Real GDP	32
1.4	GDP Deflator	33
1.5	CPI	35
1.6	Labor Market Variables	38
4.1	Real GDP per Worker in the US 1950-2011	59
4.2	Capital per worker in the US 1950-2011.	61
4.3	Capital to Output Ratio in the U.S. 1950–2011	62
4.4	Labor Share in the US 1950-2011.	63
4.5	Return on capital in the US 1950-2011.	65
4.6	Wages in the US 1950-2011.	66
4.7	Relationship Between Human Capital and Income per Person	70
5.1	Plot of Central Equation of Solow Model	84
5.2	Convergence to Steady State from $k_t < k^*$	85
5.3	Convergence to Steady State from $k_t > k^*$	86
5.4	Convergence to Steady State	87
5.5	Alternative Plot of Central Equation of Solow Model	88
5.6	Exogenous Increase in s , $s_1 > s_0$	90
5.7	Dynamic Responses to Increase in s	91
5.8	Dynamic Path of Output Growth	93
5.9	Exogenous Increase in A , $A_1 > A_0$	94
5.10	Dynamic Responses to Increase in A	95
5.11	Dynamic Path of Output Growth	96
5.12	s and c^* : The Golden Rule	98
5.13	The Golden Rule Saving Rate	100
5.14	Effects of $\uparrow s$ Above and Below the Golden Rule	101
6.1	Plot of Central Equation of Augmented Solow Model	114

6.2	Increase in s	117
6.3	Dynamic Responses to Increase in s	118
6.4	Dynamic Responses to Increase in s , Per Worker Variables	119
6.5	Dynamic Path of Output Per Worker Growth	120
6.6	Increase in A	121
6.7	Dynamic Responses to Increase in A	122
6.8	Dynamic Responses to Increase in A , Per Worker Variables	123
6.9	Dynamic Responses to Increase in s , Quantitative Exercise	125
6.10	Dynamic Responses to Increase in s , Quantitative Exercise, Per Worker Variables	126
6.11	Dynamic Responses to Increase in s , Quantitative Exercise Per Worker Output Growth	127
6.12	The Golden Rule Saving Rate	128
7.1	Country 1 Initially Endowed With More Capital than Country 2	135
7.2	Paths of Capital and Output Growth for Countries 1 and 2	136
7.3	Initial GDP Per Capita in 1950 and Cumulative Growth From 1950–2010	137
7.4	Initial GDP Per Capita in 1950 and Cumulative Growth From 1950–2010 OECD Countries	138
7.5	Real GDP Per Capita Relative to the United States	139
7.6	Scatter Plot: TFP and GDP Per Worker in 2011	143
8.1	Plot of the Central Equation of the OLG Model	160
8.2	Dynamics in the OLG Model	161
8.3	Quantitative Convergence in the OLG Model	162
8.4	Implementing Taxes to Hit the Golden Rule	169
8.5	Implementing Taxes to Hit the Golden Rule: Starting from Dynamic Inefficiency	171
9.1	Utility and Marginal Utility	185
9.2	Budget Line	190
9.3	Indifference Curves	192
9.4	An Optimal Consumption Bundle	193
9.5	Increase in Y_t	194
9.6	Increase in Y_{t+1}	195
9.7	Increase in r_t and Pivot of the Budget Line	197
9.8	Increase in r_t : Initially a Borrower	197
9.9	Increase in r_t : Initially a Saver	199
9.10	Increase in Q_t	204

9.11	Increase in Q_{t+1}	206
9.12	Expected Marginal Utility and Marginal Utility of Expected Consumption . .	212
9.13	An Increase in Uncertainty	214
9.14	Borrowing Constraint: $S_t \geq 0$	218
9.15	Borrowing Constraint: $r_t^b > r_t^s$	219
9.16	A Binding Borrowing Constraint	220
9.17	A Binding Borrowing Constraint, Increase in Y_t	221
9.18	A Binding Borrowing Constraint, Increase in Y_{t+1}	222
10.1	Consumption and Income: The Life Cycle	241
10.2	The Stock of Savings over The Life Cycle	242
11.1	Expenditure and Income	252
11.2	Derivation of the IS Curve	254
11.3	IS Curve Shift: $\uparrow Y_{t+1}$	255
11.4	The Y^s Curve	256
11.5	Equilibrium	257
11.6	Supply Shock: Increase in Y_t	258
11.7	Demand Shock: Increase in Y_{t+1}	259
11.8	Real Interest Rates and Expected Output Growth	261
12.1	The Production Function	272
12.2	Labor Demand	276
12.3	Investment Demand	278
12.4	The Consumption-Leisure Budget Line	286
12.5	Optimal Consumption-Leisure Choice	287
12.6	Optimal Consumption-Leisure Choice, Increase in w_t	288
12.7	Labor Supply	290
13.1	Budget Line	298
13.2	Increase in G_t	301
13.3	Increase in G_{t+1}	303
16.1	Total Hires and separations in the US 2000-2016	348
16.2	Net job creation in the US 2000-2016.	349
16.3	Separations in the US 2000-2016.	350
16.4	Job finding rate in the US 2000-2016.	351
16.5	Job finding rate in the US 2000-2016.	351

16.6	The top panel shows the transition dynamics starting at $u_0 = 0.047$. The bottom panel shows the transition dynamics associated with moving to a lower separation rate.	355
17.1	Desired Expenditure and Income	378
17.2	Desired Expenditure and Income	379
17.3	Desired Expenditure and Income: Expenditure Equals Income	380
17.4	The IS Curve: Derivation	381
17.5	The Y^s Curve: Derivation	382
17.6	$IS - Y^s$ Equilibrium	384
17.7	Money Demand	385
17.8	Money Demand, Alternative Graphical Representations	386
17.9	Money Supply	386
17.10	Equilibrium in the Money Market	387
18.1	$IS - Y^s$ Equilibrium	391
18.2	Equilibrium in the Money Market	392
18.3	Increase in A_t	394
18.4	Increase in A_t : The Money Market	395
18.5	Increase in A_{t+1}	397
18.6	Increase in A_{t+1} : The Money Market	398
18.7	Increase in G_t	400
18.8	Increase in G_t : The Money Market	401
18.9	Increase in M_t	405
18.10	Increase in π_{t+1}^e	406
19.1	Cyclical Component of Real GDP	413
19.2	Increase in A_t and A_{t+1}	418
19.3	Cyclical Components of Real GDP and TFP	420
20.1	Different Measures of the Money Supply	426
20.2	M2 and the Monetary Base	428
20.3	M2 Divided by the Monetary Base	429
20.4	Scatter Plot: Money Growth and Inflation	432
20.5	Smoothed Money Growth and Inflation	433
20.6	Velocity	434
20.7	Nominal Federal Funds Rate	435
20.8	Smoothed Inflation and Interest Rates	437

20.9	Cyclical Components of Real GDP and the Money Supply	439
21.1	Cyclical Components of GDP and Utilization-Adjusted TFP	447
21.2	Cyclical Components of GDP and Baa Credit Spread	450
22.1	IS Curve: Open vs. Closed Economy	461
22.2	IS Curve: Small Open Economy	462
22.3	Shift of IS Curve due to $\uparrow G_t$: Open vs. Closed Economy	463
22.4	$IS - Y^s$ Equilibrium	465
22.5	Equilibrium in the Money Market	466
22.6	Equilibrium Real Exchange Rate	467
22.7	Effects of a Positive IS Shock	468
22.8	Effect of Positive IS Shock on the Price Level	470
22.9	Effects of Positive IS Shock on the Real Exchange Rate	470
22.10	Effects of an Increase in A_t	472
22.11	Effect of Increase in A_t on the Price Level	473
22.12	Effects of Increase in A_t Shock on the Real Exchange Rate	474
22.13	Effects of Increase in Q_t	475
22.14	Effect of Increase in Q_t on the Price Level	476
22.15	Effects of Increase in Q_t Shock on the Real Exchange Rate	476
22.16	Effect of Increase in M_t	477
23.1	The LM Curve: Derivation	487
23.2	The LM Curve: Increase in M_t	487
23.3	The LM Curve: Increase in P_t	488
23.4	The LM Curve: Increase in π_{t+1}^e	489
23.5	The IS Curve: Derivation	490
23.6	The AD Curve: Derivation	492
23.7	Shift of the AD Curve: Increase in M_t	493
23.8	Shift of the AD Curve: IS Shock	494
24.1	Derivation of the AS Curve	500
24.2	Shift of the Neoclassical AS Curve: Increase in A_t	501
24.3	Shift of the Neoclassical AS Curve: Increase in θ_t	502
24.4	The Simple Sticky Price AS Curve: Derivation	505
24.5	Shift of the Simple Sticky Price AS Curve: Increase in \bar{P}_t	506
24.6	The Partial Sticky Price AS Curve: Derivation	509
24.7	The Partial Sticky Price AS Curve: Role of γ	511

24.8	Shift of the Partial Sticky Price AS Curve: $\uparrow \bar{P}_t$	513
24.9	Shift of the Partial Sticky Price AS Curve: $\uparrow A_t$	514
24.10	Shift of the Partial Sticky Price AS Curve: $\uparrow \theta_t$	515
25.1	Neoclassical IS-LM-AD-AS Equilibrium	519
25.2	Neoclassical Model: Increase in M_t	521
25.3	Neoclassical Model: Increase in A_t	522
25.4	Neoclassical Model: Positive IS Shock	524
25.5	Equilibrium in the Simple Sticky Price Model	526
25.6	Simple Sticky Price: Effect of Increase in M_t	528
25.7	Simple Sticky Price: Effect of Positive IS Shock	530
25.8	Simple Sticky Price: Effect of Increase in A_t	532
25.9	Simple Sticky Price: Effect of Increase in θ_t	533
25.10	Simple Sticky Price: Effect of Increase in \bar{P}_t	534
25.11	Equilibrium in the Partial Sticky Price Model	537
25.12	Partial Sticky Price: Effect of Increase in M_t	539
25.13	Partial Sticky Price: Effect of Positive IS Shock	541
25.14	Partial Sticky Price: Effect of Increase in A_t	543
25.15	Partial Sticky Price: Effect of Increase in θ_t	545
25.16	Partial Sticky Price: Effect of Increase in \bar{P}_t	546
26.1	Sticky Price Model: $Y_{0,t}^{sr} < Y_{0,t}^f$	554
26.2	Sticky Price Model: $Y_{0,t}^{sr} < Y_{0,t}^f$, Short Run to Medium Run Price Adjustment	556
26.3	Simple Sticky Price Model: Increase in M_t , Short Run to Medium Run	558
26.4	Short Run and Medium Responses: Increase in M_t	559
26.5	Simple Sticky Price Model: Positive IS Shock, Short Run to Medium Run	560
26.6	Short Run and Medium Responses: Positive IS Shock	561
26.7	Sticky Price Model: Increase in A_t , Short Run to Medium Run	562
26.8	Short Run and Medium Responses: Increase in A_t	563
26.9	Partial Sticky Price Model: $Y_{0,t} < Y_{0,t}^f$	565
26.10	Partial Sticky Price Model: $Y_{0,t} < Y_{0,t}^f$, Short Run to Medium Run Price Adjustment	567
26.11	Partial Sticky Price: Increase in M_t , Short Run to Medium Run	569
26.12	Short Run and Medium Responses: Increase in M_t	570
26.13	Short Run and Medium Responses: Increase in M_t Comparing Simple Sticky Price to Partial Sticky Price Model	571
26.14	Partial Sticky Price: Positive IS Shock, Short Run to Medium Run	572

26.15	Short Run and Medium Responses: Positive IS Shock	573
26.16	Partial Sticky Price: Effect of Increase in A_t , Dynamics	574
26.17	Short Run and Medium Responses: Increase in A_t	575
26.18	Inflation and the Output Gap	577
26.19	Inflation and the Output Gap	578
26.20	Average Inflation Expectations	579
26.21	Sticky Price Model: Anticipated Increase in M_t , Reflected in π_t^e	582
26.22	Sticky Price Model: Unanticipated Disinflation	584
26.23	Sticky Price Model: Anticipated Disinflation	586
27.1	Equilibrium in the Partial Sticky Price Model	593
27.2	Optimal Monetary Response to Positive IS Shock	594
27.3	Optimal Monetary Response to Increase in A_t	596
27.4	Optimal Monetary Response to Increase in \bar{P}_t	598
27.5	A Strict Inflation (Price Level) Target and the Effective AD Curve	600
27.6	A Strict Inflation (Price Level) Target: Response to Positive IS Shock	601
27.7	A Strict Inflation (Price Level) Target: Response to $\uparrow A_t$ or $\downarrow \theta_t$	602
27.8	A Strict Inflation (Price Level) Target: Response to $\uparrow \bar{P}_t$	603
27.9	The Natural Rate of Interest	605
27.10	IS Shocks and the Natural Rate of Interest	606
27.11	Y_t^f Shocks and the Natural Rate of Interest	607
27.12	Using Fiscal Policy to Combat an IS Shock	609
27.13	Actual and Monetary Policy Rule Implied Fed Funds Rate	611
28.1	The LM Curve and the ZLB	615
28.2	AD Derivation with a Non-Binding ZLB	616
28.3	AD Derivation with a Binding ZLB	617
28.4	AD Derivation with Both a Binding and Non-Binding ZLB	618
28.5	Changes in the Money Supply and a Binding ZLB	619
28.6	Sticky Price Model: Negative IS Shock with Binding ZLB	621
28.7	Sticky Price Model: Positive Supply Shock with Binding ZLB	623
28.8	Medium Run Supply-Side Dynamics at the ZLB, Sticky Price Model	625
28.9	Medium Run Supply-Side Dynamics at the ZLB, Deflationary Expectations, Sticky Price Model	627
28.10	Sticky Price Model: Fiscal Expansion with Binding ZLB	629
28.11	Fiscal Expansion to Exit the ZLB	630
28.12	Engineering Higher Expected Inflation to Exit the ZLB	631

29.1	The AD Curve: Open vs. Closed Economy	638
29.2	Equilibrium in the Open Economy Sticky Price Model	640
29.3	Increase in M_t : Open vs. Closed Economy	642
29.4	Positive IS Shock: Open vs. Closed Economy	644
29.5	Equilibrium in the Small Open Economy Sticky Price Model	647
29.6	Increase in M_t : Small Open vs. Closed Economy	648
29.7	Effect of an Increase in r_t^F	651
29.8	Effect of an Increase in Q_t	653
29.9	A Positive IS Shock and a Fixed Exchange Rate Regime	656
29.10	An Increase in r_t^F in a Fixed Exchange Rate Regime	658
30.1	Financial Intermediation	666
30.2	Traditional Banking System	685
30.3	Shadow Banking System	686
31.1	The M1 Money Multiplier and Its Components	694
31.2	Money Stock Measures: Great Depression	715
31.3	Federal Reserve Assets	719
31.4	Money Stock Measures: Great Recession	721
33.1	Increase in Current Endowment	748
33.2	Increase in Future Endowment	748
33.3	Bond Prices and p_1 : Income Always High	754
33.4	Yields and Risk Premium: Income Always High	755
33.5	Bond Prices and p_3 : Income Always Low	756
33.6	Yields and Risk Premium: Income Always Low	757
33.7	Bond Prices and p_1 : No Default Risk	758
33.8	Yields: No Default Risk	759
33.9	Yields: No Default Risk	761
33.10	Yields: 10 Yr Treasury Note and Three Month Treasury Bill	763
33.11	Representative Yield Curves	764
33.12	Yield Curves Prior to Recent Recessions	764
33.13	The Yield Curve and the Term Premium	782
33.14	The Markets for Short and Long Term Government Bonds	789
33.15	The Market for Long Term Risky Bonds	790
33.16	Conventional Monetary Policy: Open Market Purchase	792
33.17	Conventional Monetary Policy: Impact on Market for Risky Long Term Debt	793

33.18	The Zero Lower Bound and the Market for Short Term Riskless Bonds	794
33.19	Unconventional Monetary Policy: Forward Guidance	796
33.20	Forward Guidance and the Market for Risky Long Term Debt	797
33.21	Unconventional Monetary Policy: Quantitative Easing, Government Securities	798
33.22	Quantitative Easing (Government Securities) and Market for Risky Long Term Debt	799
33.23	Quantitative Easing (Risky Long Term Debt)	800
34.1	The Equity Premium	804
34.2	Total Stock Market Price Index	804
34.3	Simulated Stock Price: No Bubbles	834
34.4	Simulated Bubble Process	835
34.5	Actual and Fundamental Stock Price	836
34.6	PE Ratio and Subsequent 20 Year Realized Return: S&P 500	837
34.7	Price-Dividend Ratio and Subsequent Realized Return: Model with No Bubble	838
34.8	Price-Dividend Ratio and Subsequent Realized Return: Bubbles	839
35.1	Empirical Measure of f_t	850
35.2	Equilibrium in the Partial Sticky Price Model with Financial Frictions	851
35.3	Increase in Credit Spread	856
35.4	The IS Curve with the Financial Accelerator	859
35.5	The AD Curve with the Financial Accelerator	861
35.6	Shift of the IS Curve with the Financial Accelerator	862
35.7	IS-LM-AD-AS Curves with Financial Accelerator	863
35.8	Supply Shock with Financial Accelerator	864
35.9	Demand Shock with Financial Accelerator, Simple Sticky Price Model	865
36.1	S&P 500 Stock Market Index Around Great Depression	869
36.2	Real Home Price Index Around Great Recession	869
36.3	Interest Rate Spread Around Great Depression	871
36.4	Interest Rate Spread Around Great Recession	872
36.5	Industrial Production Index Around Great Depression	873
36.6	Industrial Production Index Around Great Recession	873
36.7	Repo Haircuts During the Crisis	877
36.8	AA-AAA Spread	879
36.9	The TED Spread During the Financial Crisis	880
36.10	2007 Decline in House Prices	882

36.11	2007-2008 Financial Crisis	883
36.12	Federal Funds Rate Around Great Recession	884
36.13	The ZLB and the Intensification of the Financial Crisis in 2008-2009	885
36.14	Intensification of the Financial Crisis in 2008-2009 with and without the ZLB	886
36.15	Price Level and Inflation Rate Around Great Recession	887
36.16	Real GDP and Hypothetical Trend	888
36.17	Emergency Fed Lending	890
36.18	AD-AS Effects of Federal Reserve Lending Programs	892
36.19	AD-AS Effects of Fiscal Stimulus	894
36.20	Demand and Supply for a Bond, Segmented Markets	897
36.21	Unconventional Asset Holdings by Fed	898
36.22	Desired Effects of Quantitative Easing Programs	899
36.23	AD-AS Effects of Federal Reserve Quantitative Easing and Forward Guidance	902
A.1	$Y_t = \ln X_t$ and $\frac{dY_t}{dX_t}$	936
A.2	$Y = X^2$	942
A.3	$Y = \ln X - 2X$	943
C.1	The Y^s Curve: Derivation with Intertemporal Labor Supply	965
C.2	$IS - Y^s$ Equilibrium with Upward-Sloping Y^s Curve	967
C.3	Equilibrium in the Money Market	968
C.4	Increase in A_t with Upward-Sloping Y^s Curve	969
C.5	Increase in A_t : the Money Market	970
C.6	Positive IS Shock with Upward-Sloping Y^s Curve	971
C.7	Positive IS Shock: the Money Market	972
D.1	The Sticky Wage AS Curve: Derivation	975
D.2	The Sticky Wage AS Curve: Increase in A_t	977
D.3	The Sticky Wage AS Curve: Increase in \bar{W}_t	978
D.4	Sticky Wage IS-LM-AD-AS Equilibrium	981
D.5	Effects of Increase in M_t	982
D.6	Effects of Positive IS Shock	985
D.7	Effects of Increase in A_t	986
D.8	Effects of Increase in \bar{W}_t	988
D.9	Effects of Increase in A_t on Sticky Wage AS and Neoclassical AS	990
D.10	Effects of Increase in A_t on Sticky Wage AS and Neoclassical AS, Slope of AD	991
D.11	Sticky Wage Model: $Y_{0,t} > Y_{0,t}^f$	994

D.12 Sticky Wage Model: $Y_{0,t} > Y_{0,t}^f$, Dynamic Wage Adjustment	995
D.13 Sticky Wage Model: Increase in M_t , Dynamics	997
D.14 Sticky Wage Model: Positive IS Shock, Dynamics	999
D.15 Sticky Wage Model: Increase in A_t , Dynamics	1001
E.1 The MP Curve	1004
E.2 The AD Curve with the MP Curve: Derivation	1006
E.3 Shift of the AD Curve: Positive <i>IS</i> Shock	1007
E.4 Shift of the AD Curve: Reduction in \bar{r}_t	1008
E.5 The AD Curve with the MP Curve: Role of ϕ_π	1009
E.6 Supply Side of the Model	1011
E.7 The IS-MP-AD-AS Equilibrium	1013
E.8 Positive IS Shock	1014
E.9 Increase in \bar{r}_t	1015
E.10 Increase in A_t	1016

List of Tables

4.1	GDP Per Capita for Selected Countries	68
4.2	Growth Miracles and Growth Disasters	69
9.1	Income and Substitution Effects of Higher r_t	200
18.1	Qualitative Effects of Exogenous Shocks on Endogenous Variables	407
19.1	Correlations Among Variables in the Data and in the Model	414
20.1	Dynamic Correlations between M2 and Output	440
22.1	Qualitative Effects of Exogenous Shocks on Endogenous Variables in Open Economy Model	478
23.1	LM Curve Shifts	489
23.2	IS Curve Shifts	490
23.3	AD Curve Shifts	494
24.1	Neoclassical AS Curve Shifts	502
24.2	Simple Sticky Price AS Curve Shifts	507
24.3	Partial Sticky Price AS Curve Shifts	516
25.1	Qualitative Effects of Exogenous Shocks on Endogenous Variables in the Neoclassical Model	525
25.2	Qualitative Effects of Exogenous Shocks on Endogenous Variables in the Simple Sticky Price Model	535
25.3	Qualitative Effects of Exogenous Shocks on Endogenous Variables in the Partial Sticky Price Model	547
25.4	Comparing the Sticky Price and Neoclassical Models	548
26.1	Qualitative Effects of Exogenous Shocks on Endogenous Variables in the Sticky Price Model, Transition from Short Run to Medium Run	564
26.2	Qualitative Effects of Exogenous Shocks on Endogenous Variables in the Partial Sticky Price Model, Transition from Short Run to Medium Run	576

27.1 Optimal Monetary Policy Reaction to Different Shocks	599
29.1 Comparing the Open and Closed Economy Variants of the Sticky Price Model	646
29.2 Comparing the Small Open and Open Economy Variants of the Sticky Price Model	650
30.1 Potential Buyer and Seller Valuations	669
30.2 T-Account for Hypothetical Bank	674
30.3 T-Account for Homeowner	676
30.4 T-Account for Hypothetical Bank	677
30.5 T-Account for Hypothetical Bank After Loan Default	677
30.6 T-Account for Hypothetical Bank	678
30.7 T-Account for Hypothetical Bank	678
30.8 T-Account for Hypothetical Bank	679
30.9 T-Account for Hypothetical Bank	680
30.10T-Account for Hypothetical Bank	680
30.11T-Account for Hypothetical Bank	681
30.12T-Account for Hypothetical Shadow Bank	687
30.13T-Account for Hypothetical Shadow Bank	688
31.1 Balance Sheet for Banking System as a Whole	694
31.2 Balance Sheet for Central Bank	695
31.3 Balance Sheet for a Particular Bank	695
31.4 Open Market Purchase from Bank A	696
31.5 Balance Sheet for Central Bank After Open Market Purchase	696
31.6 Bank A Makes a Loan	696
31.7 Bank A's Loan is Deposited Elsewhere	697
31.8 Bank B Gets a Deposit	697
31.9 Bank B Makes a Loan	697
31.10Bank B's Loan Gets Deposited Elsewhere	697
31.11Bank C Gets a Deposit	698
31.12Bank C Makes a Loan	698
31.13Funds are Withdrawn from Bank C	698
31.14Bank D Gets a Deposit	699
31.15Deposit Creation	699
31.16Balance Sheet for Banking System as a Whole After Open Market Purchase .	701
31.17Balance Sheet for Banking System as a Whole	701

31.18	Balance Sheet for Non-Bank Public	702
31.19	Balance Sheet for Central Bank	702
31.20	Balance Sheet for Government	703
31.21	Initial Balance Sheet for Bank A	703
31.22	Open Market Purchase from Bank A	704
31.23	Balance Sheet for Central Bank After Open Market Purchase	704
31.24	Bank A Makes a Loan	704
31.25	Non-Bank Public gets a Loan	704
31.26	Non-Bank Public Withdraws Cash	705
31.27	Bank A Handles Cash Withdrawal	705
31.28	Bank A's Loan is Deposited Elsewhere	706
31.29	Bank B Gets a Deposit	706
31.30	Bank B Makes a Loan	706
31.31	Non-Bank Public Gets a Loan	707
31.32	Non-Bank Public Withdraws Cash	707
31.33	Bank B Handles Withdrawal	707
31.34	Bank B's Loan is Deposited Elsewhere	708
31.35	Bank C Receives Deposit	708
31.36	Bank C Makes Loan	708
31.37	Non-Bank Public Gets a Loan	708
31.38	Non-Bank Public Withdraws Cash	709
31.39	Bank C Handles Withdrawal	709
31.40	Deposits are Withdrawn from Bank C	709
31.41	Bank D Receives a Deposit	709
31.42	Bank D Makes a Loan	710
31.43	Non-Bank Public Gets a Loan	710
31.44	Non-Bank Public Withdraws Cash	710
31.45	Funds are Withdrawn from Bank D	710
31.46	Deposits are Withdrawn from Bank D	711
31.47	Deposit, Loan, and Cash Changes	711
31.48	Stylized Great Depression Banking System Balance Sheet	716
31.49	Stylized Great Depression Non-Bank Public Balance Sheet	716
31.50	Stylized Great Depression Fed Balance Sheet	716
31.51	Stylized Great Depression Non-Bank Public Balance Sheet: Cash Withdrawal	716
31.52	Stylized Great Depression Banking System Balance Sheet: Cash Withdrawal	717
31.53	Stylized Great Depression Banking System Balance Sheet: Reducing Loans	717

31.54	Stylized Great Depression Non-Bank Public Balance Sheet: Reduction in Loans	718
31.55	Stylized Great Depression Fed Balance Sheet: After Cash Withdrawal and Loan Reduction	718
31.56	Stylized Great Recession Fed Balance Sheet: Before the Crisis	720
31.57	Stylized Great Recession Banking System Balance Sheet: Before the Crisis . .	720
31.58	Stylized Great Recession Fed Balance Sheet: After the Crisis	720
31.59	Stylized Great Recession Banking System Balance Sheet: After the Crisis . . .	721
32.1	T-Account for Bank in Bad Equilibrium	732
32.2	T-Account for Bank in Bad Equilibrium	732
32.3	T-Account for Hypothetical Bank	735
32.4	T-Account for Hypothetical Bank	735
33.1	The Nature of Uncertainty and Risk Premia	760
34.1	Uncertainty and the Equity Premium	810
34.2	Stock and Bond Pricing: Three Periods	825
36.1	T-Account for Bear Stearns	875
36.2	T-Account for Bear Stearns	878
A.1	Greek Letters	929
A.2	Approximation of $\ln(1 + \alpha)$	933
A.3	Derivatives of Common Functions	936
A.4	Derivative Rules for Composite Functions	937
D.1	Sticky Wage AS Curve Shifts	979
D.2	Qualitative Effects of Exogenous Shocks on Endogenous Variables in the Sticky Wage Model	989
D.3	Comparing the Sticky Wage and Neoclassical Models	992
D.4	Qualitative Effects of Exogenous Shocks on Endogenous Variables in the Sticky Wage Model, Transition from Short Run to Medium Run	1002

Part VII
Appendices

Appendix A

Mathematical Appendix

Modern economics makes use of mathematics. Mathematics is a convenient and clean tool to express ideas formally. Mathematics is well-suited for the rigorous comparison of concepts in a formal model to observed data on economic variables. This book makes use of a good deal of mathematics. Most of the mathematics that we use is high school level algebra and basic calculus. This appendix reviews several mathematical concepts which will be used throughout the book.

A.1 Variables and Parameters

A variable is something which can be represented by a number that can change. In economic models, there are two types of variables. An exogenous variable is a variable whose value is determined “outside of the model.” Put differently, the value of an exogenous variable is taken as given when working through a model. An endogenous variable is a variable whose value is determined “inside of the model.” The values of endogenous variables are determined given the structure of the model, taking the value of exogenous variables as given. An example of an endogenous variable in economics is a price – it is determined by the forces of supply and demand. An example of an exogenous variable is the taste a consumer has for some good. We take the consumer’s preferences (i.e. its taste for a particular good) as given, and hence exogenous. Given tastes (as well as other factors), we determine endogenous variables in the context of a model. We will typically denote variables with Latin letters.

Because macroeconomics is focused on observations of variables at a point in time, we will index variables by the period in which they are observed. In particular, let t be a period index (which could be years, quarters, months, etc.). Y_t denotes the value of the variable Y observed in period t . We often take period t to denote the present period, so Y_{t-1} would denote the value of the variable Y observed one period ago, while Y_{t+1} would denote the value observed one period in the future. We will use the notation that $\Delta Y_t = Y_t - Y_{t-1}$ denotes the first difference of a variable across adjacent periods of time.

A parameter is a constant which governs mathematical relationships in a model. We will typically use either lowercase Greek letters or lowercase Latin letters (without time

subscripts) to denote parameters. Table A.1 provides several different symbols for lowercase Greek letters and their pronunciation.

Table A.1: Greek Letters

Symbol	Name
α	alpha
β	beta
γ	gamma
δ	delta
ϵ	epsilon
θ	theta
κ	kappa
ρ	rho
σ	sigma
ϕ	phi
χ	chi

The equation below provides a very simple example of an economic model:

$$Y_t = \alpha + \beta X_t \tag{A.1}$$

In (A.1), X_t is an exogenous variable (the variable X observed at date t) and Y_t is an endogenous variable. α and β are parameters. Given a value of the exogenous variable X_t , and given values of α and β , you can determine the value of Y_t . The parameter β measures how Y_t changes as X_t changes.

A.2 Exponents and Logs

We will be making frequent use of exponents and natural logs. The following are a sequence of rules for exponents. X_t and Y_t denote variables and α and β are constant parameters:

$$\begin{aligned}
X_t^1 &= X_t & (A.2) \\
X_t^0 &= 1 \\
X_t^{-1} &= \frac{1}{X_t} \\
X_t^{-\alpha} &= \frac{1}{X_t^\alpha} \\
X_t^\alpha X_t^\beta &= X_t^{\alpha+\beta} \\
\frac{X_t^\alpha}{X_t^\beta} &= X_t^{\alpha-\beta} \\
(X_t^\alpha)^\beta &= X_t^{\alpha\beta} \\
X_t^\alpha Y_t^\alpha &= (X_t Y_t)^\alpha
\end{aligned}$$

The natural log, which we will denote by \ln or \log , is the inverse operator for the exponential function, which we will denote by $\exp(X_t)$ or e^{X_t} . e is called “Euler’s number,” and is approximately equal to 2.718. Below are some properties of the natural log and exponential function:

$$\begin{aligned}
\ln(\exp(X_t)) &= X_t & (A.3) \\
\exp(\ln X_t) &= X_t \\
\ln X_t^\alpha &= \alpha \ln X_t \\
\ln(X_t Y_t) &= \ln X_t + \ln Y_t \\
\ln\left(\frac{X_t}{Y_t}\right) &= \ln X_t - \ln Y_t \\
\ln 1 &= 0 \\
\ln 0 &\rightarrow -\infty \\
\exp(0) &= 1 \\
\exp(-\infty) &\rightarrow 0
\end{aligned}$$

A.3 Summations and Discounted Summations

In some applications we will be interested in summations of variables across time. Suppose that we want to sum up the value of X in periods t , $t + 1$, and $t + 2$. Formally:

$$S = X_t + X_{t+1} + X_{t+2} \quad (\text{A.4})$$

We can write this in short hand using the summation operator, denoted by Σ (uppercase Greek sigma):

$$S = \sum_{j=0}^2 X_{t+j} \quad (\text{A.5})$$

j is an integer index. The bottom part of the summation operator denotes where we start the sum (in this case, at $j = 0$). Starting with $j = 0$, you plug this in to X_{t+j} and you get X_t . Then you go to the next integer, $j = 1$. You get X_{t+1} . You add this to the previous element, so you have $X_t + X_{t+1}$. You keep doing this until you get to the number/symbol at the top of the summation operator, in this case 2. More generally, the sum of the variable X from periods t to $t + T$, where $T > 0$, is:

$$S = \sum_{j=0}^T X_{t+j} = X_t + X_{t+1} + \dots + X_{t+T} \quad (\text{A.6})$$

You can also use summation operators to sum backwards in time. To do this, instead of writing $+j$ in the subscripts on X , simply write $-j$. For example:

$$S = \sum_{j=0}^T X_{t-j} = X_t + X_{t-1} + \dots + X_{t-T} \quad (\text{A.7})$$

The summation of a constant times a variable is equal to the constant times the summation of a variable:

$$\sum_{j=0}^T \alpha X_{t+j} = \alpha \sum_{j=0}^T X_{t+j} \quad (\text{A.8})$$

Suppose that you want to take the summation of two (or more) different variables across time. You can distribute the summation operator across the two variables. In particular:

$$\sum_{j=0}^T (X_{t+j} + Y_{t+j}) = \sum_{j=0}^T X_{t+j} + \sum_{j=0}^T Y_{t+j} \quad (\text{A.9})$$

We will often be interested in computing discounted sums. Suppose that $0 \leq \alpha < 1$ is a parameter and that $X_{t+j} = \alpha^j X_t$. Suppose we want to compute the sum:

$$S = \sum_{j=0}^T X_{t+j} \quad (\text{A.10})$$

We can write this as:

$$S = \sum_{j=0}^T \alpha^j X_t \quad (\text{A.11})$$

Because X_t now does not vary with j , we can factor it out of the summation operator:

$$S = X_t \sum_{j=0}^T \alpha^j \quad (\text{A.12})$$

Define S' as the sum of α raised to successively higher powers:

$$S' = \sum_{j=0}^T \alpha^j = \alpha^0 + \alpha^1 + \alpha^2 + \dots + \alpha^T \quad (\text{A.13})$$

Multiply both sides of the sum by α :

$$\alpha S' = \alpha^1 + \alpha^2 + \dots + \alpha^{T+1} \quad (\text{A.14})$$

Then, subtracting (A.14) from (A.13), we have:

$$S'(1 - \alpha) = 1 - \alpha^{T+1} \quad (\text{A.15})$$

Solving for S' :

$$S' = \frac{1 - \alpha^{T+1}}{1 - \alpha} \quad (\text{A.16})$$

If T is sufficiently large, or α sufficiently close to zero, $\alpha^{T+1} \approx 0$, and we can approximate the sum as:

$$S' = \frac{1}{1 - \alpha} \quad (\text{A.17})$$

A.4 Growth Rates

The growth rate of a variable is defined as its change between two periods of time divided by the value in the “base” period. This is a general expression for a percentage difference, the change in a variable divided by its base. Most often when using the term growth rate we will mean the percentage change across two adjacent periods of time, but one could define growth rates over longer time horizons.

Formally, define the period-over-period growth rate of variable X_t as:

$$g_t^X = \frac{X_t - X_{t-1}}{X_{t-1}} = \frac{\Delta X_t}{X_{t-1}} \quad (\text{A.18})$$

One can re-arrange this to get:

$$1 + g_t^X = \frac{X_t}{X_{t-1}} \quad (\text{A.19})$$

One typically refers to g_t^X as the “net growth rate” and $1 + g_t^X$ as the “gross growth rate.” The gross growth rate is just equal to the ratio of a variable across time.

A useful fact is that the log of one plus a small number is approximately equal to the small number. In particular:

$$\ln(1 + \alpha) \approx \alpha \quad (\text{A.20})$$

Table A.2 shows the actual value of $\ln(1 + \alpha)$ for different values of α . One can see that the approximation is pretty good. It is best for values of α closest to zero.

Table A.2: Approximation of $\ln(1 + \alpha)$

α	$\ln(1 + \alpha)$
-0.10	-0.1054
-0.05	-0.0513
-0.01	-0.0101
0.01	0.0100
0.03	0.0296
0.05	0.0488
0.10	0.0953

Since growth rates are typically small numbers (i.e. a 2 percent growth rate is 0.02), we can use (A.20) to approximate the growth rate of a variable as the log first difference:

$$g_t^X \approx \ln X_t - \ln X_{t-1} = \Delta \ln X_t \quad (\text{A.21})$$

The approximation is sufficiently good that we will treat the log first difference as equal to the growth rate. This approximation has several useful insights. First, this makes it clear why we often like to plot macroeconomic variables in logs rather than levels. Plotting in logs means that we can interpret differences across time as approximate percentage differences, and the slope of a trending series plotted in the log is approximately the average growth rate. Second, we can apply this approximation more generally, treating the log difference between any two variables (not necessarily the same variable observed at different points in time) as the approximate percentage difference. Third, we can use this insight to think about growth rates of functions of variables.

As an example of the latter, suppose that $Y_t = X_t Z_t$. Taking logs, one gets $\ln Y_t = \ln X_t + \ln Z_t$. Then taking first differences, one gets $\Delta \ln Y_t = \Delta \ln X_t + \Delta \ln Z_t$. Since log first differences are approximately equal to growth rates, this tells us that the growth rate of a product of variables is approximately equal to the sum of the growth rates. Similarly, the growth rate of a quotient of variables is approximately the difference in the growth rates of the variables.

A.5 Systems of Equations

In economics one often finds that the variables of interest are related to each other in a way that can be expressed as a system of equations. As a simple example of a system of equations, suppose that we have demand and supply curves for some good:

$$Q_t = X_t - aP_t \tag{A.22}$$

$$Q_t = bP_t$$

Here, Q_t is the quantity of the good and P_t is the price. The first equation is the demand function (decreasing in price) and the second is the supply function (increasing in price). X_t is an exogenous variable representing tastes for the good, and a and b are positive parameters. P_t and Q_t are the endogenous variables, and X_t is an exogenous variable. Sometimes one will see endogenous variables referred to as “unknowns” (the variables we are attempting to solve for) and exogenous variables as “knowns” (the variables whose values are taken as given). Here we have two equations in two unknowns. Since we are working with a linear system of equations (Q_t and P_t enter both demand supply functions in a linear fashion – e.g. no exponents and no multiplication/division), there being the same number of equations as unknowns will ordinarily mean that there is a unique solution for the unknowns. If the system of equations were non-linear, the analysis is often more complicated and a solution may or may not exist.

We can solve this system of equations by plugging the demand function into the supply function, which eliminates Q_t and leaves one equation in one unknown (P_t). Doing so yields:

$$bP_t = X_t - aP_t \tag{A.23}$$

Simplifying and solving for P_t yields:

$$P_t = \frac{X_t}{a + b} \tag{A.24}$$

Now that we have solved for P_t in terms of just the exogenous variable, X_t , and the parameters a and b , we can solve for Q_t . Simply plug this expression for P_t into *either* the demand or supply function. Doing so for the supply function yields:

$$Q_t = \frac{b}{a+b} X_t \quad (\text{A.25})$$

One has solved a system of equations when one can express each endogenous variable as a function of exogenous variables and parameters only. We have done so here. Economically, we see that both price and quantity are increasing in the exogenous variable X_t (which governs tastes). If one were to draw graphs, an increase in X_t would shift the demand curve to the right and would result in both a higher price and a higher quantity. This is what we observe here mathematically.

In a two equation linear system, it is fairly straightforward to solve for the endogenous variables by hand, as we have done here. In a system of equations with many more variables this process can become unwieldy. The mathematical field of linear algebra offers some tools that can help deal with larger systems of equations.

A.6 Calculus

Suppose that Y_t is a continuous (i.e. no discrete breaks) function of X_t that has no kinks, given by $Y_t = f(X_t)$. $f(\cdot)$ is a function which “maps” a value of X_t into Y_t . The derivative is a measure of how the value of the function changes as X_t changes. It is important to note the distinction between the derivative (which is itself a function) and the derivative evaluated at a point (which is a number).

We will use the following notation to denote a derivative:

$$\frac{dY_t}{dX_t} = f'(X_t) \quad (\text{A.26})$$

In words, the left hand side says “the change in Y_t for a change in X_t .” The notation on the right hand side, $f'(X_t)$, is notation for denoting the derivative of f with respect to X_t . The second derivative is just the derivative of the derivative – it is a measure of how the change in the function changes as X_t changes. Formally:

$$\frac{d^2 Y_t}{dX_t^2} = f''(X_t) \quad (\text{A.27})$$

You can calculate many higher order derivatives – e.g. the third derivative is the derivative of the second derivative, and so on. Below are some derivatives of particular functions:

Table A.3: Derivatives of Common Functions

$f(X_t)$	$f'(X_t)$
α	0
αX_t	α
X_t^α	$\alpha X_t^{\alpha-1}$
$\ln X_t$	$\frac{1}{X_t}$
$\exp(X_t)$	$\exp(X_t)$

The last line here is not a typo – the exponential function has the special property that it is its own derivative.

Note that the derivative is itself a function. Consider the function $Y_t = \ln X_t$. The upper panel of Figure A.1 plots Y_t as a function of X_t for a range of values of X_t . The lower panel plots the derivative of Y_t with respect to X_t , which for this function is simply equal to $\frac{1}{X_t}$. The derivative at a point is the value of the derivative evaluated at a particular value of X_t . For example, at $X_t = 0.5$, the derivative is 2; at $X_t = 2$, the derivative is $1/2$.

Figure A.1: $Y_t = \ln X_t$ and $\frac{dY_t}{dX_t}$

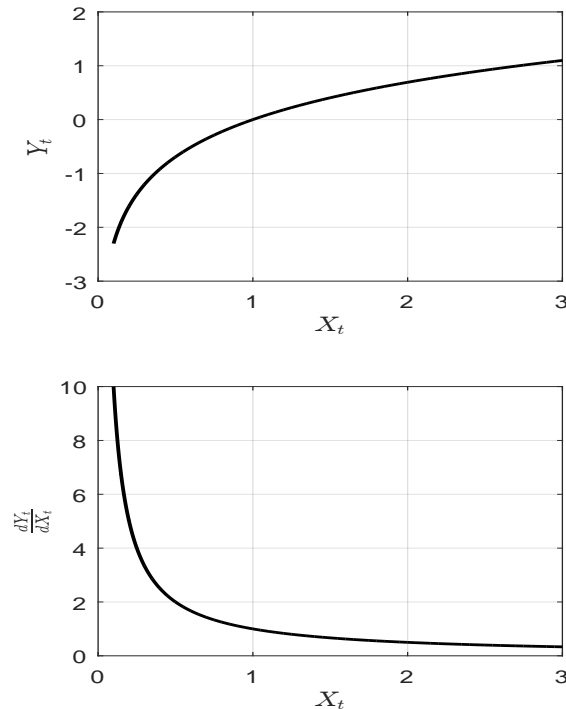

Now, suppose that you have two separate functions, $h(X_t)$ and $g(X_t)$. Suppose that $f(X_t)$ is some composite function of these two functions. Table A.4 below gives several rules for dealing with derivatives of composite functions:

Table A.4: Derivative Rules for Composite Functions

$f(X_t)$	$f'(X_t)$
$h(X_t) + g(X_t)$	$h'(X_t) + g'(X_t)$
$h(X_t)g(X_t)$	$h(X_t)g'(X_t) + g(X_t)h'(X_t)$
$\frac{h(X_t)}{g(X_t)}$	$\frac{g(X_t)h'(X_t) - h(X_t)g'(X_t)}{g(X_t)^2}$
$h(g(X_t))$	$h'(g(X_t))g'(X_t)$

The first row just says that the derivative of a sum of functions is the sum of the derivatives. The second row gives what is called the “product rule.” In words, the derivative of a product of two functions is the “first times the derivative of the second, plus the second times the derivative of the first.” The third row gives the “quotient rule.” In words, the derivative of a quotient is the “bottom times derivative of the top minus top times derivative of the bottom, divided by the bottom squared.” The final row in Table A.4 gives what is called the “chain rule.” For a function of a function, the derivative is the “derivative of the outside times the derivative of the inside.”

Example

The chain rule is an important rule that will come in handy, particularly when we are doing multivariate optimization problems. Consider an example. Suppose a function is given by:

$$Y_t = \ln [3 + 4X_t^2] \tag{A.28}$$

Here, the “outside function” is $\ln(\cdot)$, while the “inside function” is $3 + 4X_t^2$. The derivative of Y_t with respect to X_t is:

$$\frac{dY_t}{dX_t} = \frac{8X_t}{3 + 4X_t^2} \tag{A.29}$$

Here, the $\frac{1}{3+4X_t^2}$ is the “derivative of the outside” part (evaluated at the inside part) and $8X_t$ is the derivative of the inside.

In the analysis above, we considered derivatives of univariate functions – i.e. $f(\cdot)$ was a function of one variable, X_t . It is straightforward to apply the same rules outlined above to

multivariate functions. In particular, suppose that $Y_t = f(X_t, Z_t)$. The partial derivative is a measure of how Y_t changes as X_t changes, holding Z_t fixed. There is a similarly defined partial derivative for how Y_t changes as Z_t changes, holding X_t fixed. We will use the following notation:

$$\begin{aligned}\frac{\partial Y_t}{\partial X_t} &= f_X(X_t, Z_t) \\ \frac{\partial Y_t}{\partial Z_t} &= f_Z(X_t, Z_t)\end{aligned}\tag{A.30}$$

The partial derivative sign, ∂ , is different than d and denotes that all other variables are held fixed. The subscripts X and Z under the f operator refer to the variable with respect to which one is differentiating. When calculating a partial derivative, you use the same rules as above, just treating the other variable as fixed. Below are a couple of examples.

Example

Suppose that the function of interest is:

$$Y_t = \ln X_t + Z_t^\alpha\tag{A.31}$$

The partial derivatives are:

$$\begin{aligned}\frac{\partial Y_t}{\partial X_t} &= \frac{1}{X_t} \\ \frac{\partial Y_t}{\partial Z_t} &= \alpha Z_t^{\alpha-1}\end{aligned}\tag{A.32}$$

Example

Suppose that the function of interest is:

$$Y_t = X_t^\alpha Z_t^\beta\tag{A.33}$$

The partial derivatives are:

$$\begin{aligned}\frac{\partial Y_t}{\partial X_t} &= \alpha X_t^{\alpha-1} Z_t^\beta \\ \frac{\partial Y_t}{\partial Z_t} &= \beta X_t^\alpha Z_t^{\beta-1}\end{aligned}\tag{A.34}$$

Example

Suppose that the function of interest is:

$$Y_t = \ln[X_t^\alpha + \beta Z_t]\tag{A.35}$$

In calculating the partial derivatives, we have to use the chain rule here. The partial derivatives are:

$$\begin{aligned}\frac{\partial Y_t}{\partial X_t} &= \frac{\alpha X_t^{\alpha-1}}{X_t^\alpha + \beta Z_t} \\ \frac{\partial Y_t}{\partial Z_t} &= \frac{\beta}{X_t^\alpha + \beta Z_t}\end{aligned}\tag{A.36}$$

In these expressions, the $\frac{1}{X_t^\alpha + \beta Z_t}$ is the “derivative of the outside” part; $\alpha X_t^{\alpha-1}$ and β are the “derivative of the inside” parts for both X_t and Z_t .

For multivariate functions, a useful concept that will come in handy is the “total differential.” Whereas a partial derivative tells you how Y_t changes as one variable changes, holding other variables fixed, the total differential tells you how Y_t changes as both variables change. Furthermore, whereas a partial derivative only tells you how Y_t changes for a small change in X_t , the total derivative can be used to approximate the effects on Y_t of a large change in X_t . Formally, the total differential can be derived using a first order Taylor series approximation. It says:

$$dY_t \approx f_X(X, Z)dX_t + f_Z(X, Z)dZ_t\tag{A.37}$$

Here, $dY_t = Y_t - Y$, $dX_t = X_t - X$, and $dZ_t = Z_t - Z$, where Y , X , and Z are particular values of these variables. The partial derivatives are evaluated at this point – i.e. here $f_X(X, Z)$ is a number, equal to the partial derivative $f_X(X_t, Z_t)$ evaluated at the point (X, Z) . In words, the total differential says that the change in Y_t (relative to Y) is approximately equal to the

sum of the partial derivatives times the change in each variable, where the partial derivatives are evaluated at (X, Y) .

Example

Suppose that the function is:

$$Y_t = \ln[X_t + 3Z_t^2] \quad (\text{A.38})$$

The partial derivatives of this function are:

$$\begin{aligned} \frac{\partial Y_t}{\partial X_t} &= \frac{1}{X_t + 3Z_t^2} \\ \frac{\partial Y_t}{\partial Z_t} &= \frac{6Z_t}{X_t + 3Z_t^2} \end{aligned} \quad (\text{A.39})$$

Suppose that we initially have $X_t = 1$ and $Z_t = 2$. Then we have $Y_t = 2.5649$. Suppose that both X_t and Z_t change, to 1.1 and 2.1, respectively. The new value of the function is 2.6624. This means that $dY_t = 0.0975$, and $dX_t = dZ_t = 0.1$. Let's see how well the total differential approximates this change. The partial derivatives evaluated at the initial values of X_t and Z_t are 0.0769 and 0.9231, respectively. The total differential approximation would give us:

$$dY_t \approx 0.0769 \times 0.1 + 0.9231 \times 0.1 = 0.1 \quad (\text{A.40})$$

We can see that the total differential gives a good approximation ($dY_t = 0.1$) to the actual change in output ($dY_t = 0.0975$). The quality of the approximation will be worse (i) the bigger are the changes in the variables under consideration and (ii) the more non-linear the function is. If the function is linear, the total differential holds exactly – it is not an approximation.

The concept of the total differential can be used to think about the growth rate of a sum. Suppose that we have:

$$Y_t = X_t + Z_t \quad (\text{A.41})$$

The total differential gives us:

$$dY_t = dX_t + dZ_t \quad (\text{A.42})$$

Note that this holds exactly (not approximately), since Y_t is a linear function of X_t and Z_t . Suppose that the point to which you are comparing is last period's value – i.e. $dY_t = Y_t - Y_{t-1}$, $dX_t = X_t - X_{t-1}$, and $dZ_t = Z_t - Z_{t-1}$. Then we can write this:

$$\Delta Y_t = \Delta X_t + \Delta Z_t \tag{A.43}$$

Multiply and divide each term by its own lagged value, i.e.:

$$\frac{Y_{t-1}}{Y_{t-1}} \Delta Y_t = \frac{X_{t-1}}{X_{t-1}} \Delta X_t + \frac{Z_{t-1}}{Z_{t-1}} \Delta Z_t \tag{A.44}$$

Note that $\frac{\Delta Y_t}{Y_{t-1}} = g_t^Y$ – i.e. this is the growth rate. Taking note of this, and dividing both sides by Y_{t-1} , one gets:

$$g_t^Y = \frac{X_{t-1}}{Y_{t-1}} g_t^X + \frac{Z_{t-1}}{Y_{t-1}} g_t^Z \tag{A.45}$$

In words, what (A.45) says is that the growth rate of a sum equals the share-weighted sum of growth rates ($\frac{X_{t-1}}{Y_{t-1}}$ and $\frac{Z_{t-1}}{Y_{t-1}}$ are the shares of X and Z in Y , respectively). An expression like this is useful for thinking about the contributions of different expenditure categories to total GDP.

A.7 Optimization

In economics we are often interested in finding optimums of functions. The optimum of a function, $f(X)$, is the value of X , X^* , at which $f(X^*)$ is either as large (the maximum) or as small (the minimum) as possible on the feasible set of values of X .

Provided certain regularity conditions are satisfied, we can characterize optima using calculus. A necessary condition for X^* to be an interior optimum of $f(X)$ is that $f'(X^*) = 0$. By “interior” we mean that we are not considering values of X that are on the “endpoints” of the feasible set of X values. This condition is what is called a first order condition. The intuition for this is straightforward – for the case of a maximum, if a function were either increasing or decreasing at X^* , then X^* could not possibly be a maximum. If $f'(X^*) > 0$, you could increase $f(X)$ by increasing X^* . If $f'(X^*) < 0$, you could increase $f(X)$ by decreasing X^* .

We refer to points at which the first order condition is satisfied as “critical points” – these are values of X at which the derivative of $f(\cdot)$ is equal to zero. Not all critical points are “global” optima – you could have multiple points where the first order condition is satisfied, but only one represents the “global” optimum. We would refer to the other critical points as “local” maxima and minima. For most optimization problems encountered in this book, there

will only be one optimum.

The first derivative being zero is necessary for either a maximum or a minimum. So how do we tell whether the critical point is a max or a min? The answer lies in looking at the second derivative. If the second derivative (evaluated at the critical point) is negative, then the critical point is a maximum. For a critical point to be a minimum, the second derivative (evaluated at that critical point) would be positive.

We can think about maxima and minima intuitively by graphing a couple of functions. First, consider the function $Y = X^2$, where X can take on any real value (positive or negative). The plot of this function is shown in Figure A.2. One can clearly see that $X = 0$ is the minimum value of the function.

Figure A.2: $Y = X^2$

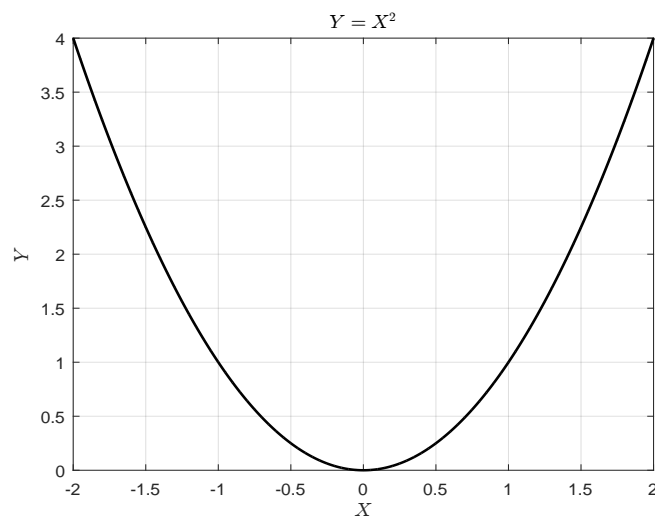

Next, consider a more interesting function. Suppose that $Y = \ln X - 2X$. The function is only defined for positive values of X . The plot is shown below. One can observe from the figure that the optimum occurs somewhere around $X = 1/2$.

Figure A.3: $Y = \ln X - 2X$

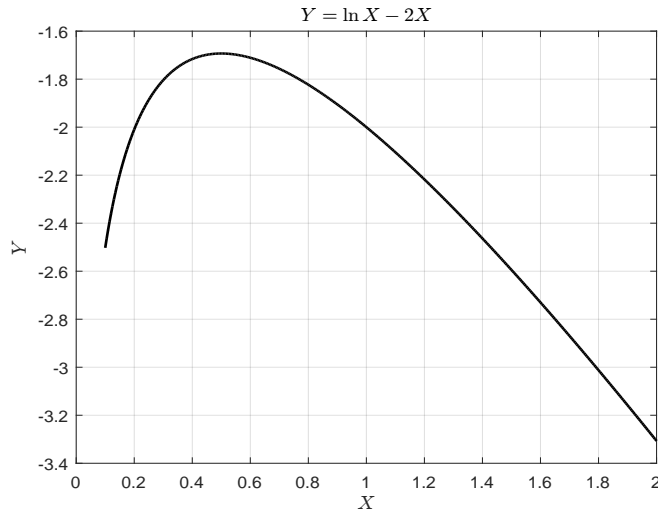

Let's work through the first and second derivatives of each function and verify that calculus gives us the right answers that we can see graphically.

Example

The function is $Y = X^2$. The first derivative is $2X$. The critical value at which this equals zero is $X^* = 0$. Is this a minimum or a maximum? The second derivative is 2, which is positive. This tells us that this critical point is a minimum. This is consistent with what we can see in Figure A.2.

Example

The function is $Y = \ln X - 2X$. The first derivative is $\frac{1}{X} - 2$. For this to equal zero, we must have $X^* = 1/2$. Is this a minimum or a maximum? The second derivative of this function is $-\frac{1}{X^2}$. This is negative. Hence, this critical point is a maximum, which is consistent with what we observe in Figure A.3.

One can usually write minimization problems as maximization problems and vice-versa. One does this by simply multiplying the function to be optimized by -1 . Suppose that you want to minimize the function $Y = X^2$. You could alternatively maximize the function $Y = -X^2$. The first derivative is $-2X$ and the critical value is $X^* = 0$ (i.e. multiplying the function by -1 does not affect the first order condition). The second derivative is now -2 , which is negative. This says that $X^* = 0$ is the maximum of the function $Y = -X^2$. Equivalently, $X^* = 0$ is the minimum of $Y = X^2$.

The basic rules of optimization that we have encountered apply equally well to multivariate problems. Suppose you have a function of two variables, $f(X, Z)$. The first order conditions

are to set the partial derivatives with respect to both arguments equal to zero: $f_X(X, Z) = 0$ and $f_Z(X, Z) = 0$. The second order conditions are a little more complicated, but basically get at the same point. Technically the second order conditions place restrictions on the Hessian, which is a matrix of second derivatives. We won't concern ourselves with any of that in this textbook.

It's a little more difficult to graphically see the optima for a multivariate function, so we'll work through a simple example:

Example

Suppose that the function we want to optimize is:

$$Y = X^\alpha Z^{1-\alpha} - aX - bZ \quad (\text{A.46})$$

Here, α , a , and b are parameters. Find the first partial derivatives:

$$\begin{aligned} \frac{\partial Y}{\partial X} &= \alpha X^{\alpha-1} Z^{1-\alpha} - a \\ \frac{\partial Y}{\partial Z} &= (1-\alpha) X^\alpha Z^{-\alpha} - b \end{aligned} \quad (\text{A.47})$$

Setting these derivatives equal to zero implies:

$$\begin{aligned} \alpha X^{\alpha-1} Z^{1-\alpha} &= a \\ (1-\alpha) X^\alpha Z^{-\alpha} &= b \end{aligned} \quad (\text{A.48})$$

The first condition implies that:

$$\left(\frac{X}{Z}\right)^{\alpha-1} = \frac{a}{\alpha} \quad (\text{A.49})$$

The second condition implies that:

$$\left(\frac{X}{Z}\right)^\alpha = \frac{b}{1-\alpha} \quad (\text{A.50})$$

Divide (A.50) by (A.49) to get:

$$\frac{X}{Z} = \frac{b - \alpha}{a(1 - \alpha)} \quad (\text{A.51})$$

This optimality condition gives us the ratio of $\frac{X}{Z}$ that is consistent with the function being maximized. However, it is not possible to determine the levels of X or Z consistent with the function being maximized – you can see this by solving (A.51) for either X or Z and plugging it into one of the first order conditions, where the X or Z will drop out.

Often times in economics we will be interested in constrained optimization problems. Constrained optimization is at the heart of economics. Economics is about how agents maximize some objective (e.g. well-being, profit) subject to the scarcity they face (e.g. limited income, limited time).

Generally, we would like to maximize some multivariate function where the values of the variables we can choose are constrained in some way. Below is a simple example of a constrained optimization problem:

$$\begin{aligned} \max_{X,Z} \quad & \ln X + \ln Z \\ \text{s.t.} \quad & \end{aligned}$$

$$X + Z \leq 1$$

Here, the “max” operator means that we want to maximize the function; the subscript X and Z refer to the fact that these are the variables we get to choose. The “s.t.” means “subject to.” The constraint is that the sum of X and Z must be weakly less than 1. One can see why the constraint matters here – if there were no constraint, the maximizing values of X and Z would be ∞ (infinity) – i.e. you’d just want these variables to be as big as possible. The constraint puts a bound on how big these can be.

For the optimization problems considered in this book, we will handle constrained optimization problems in the following way. We will assume that the constraint “binds,” which means holds with equality. Then solve for one variable in terms of other variables, and substitute back into the objective function (the function we want to optimize). This renders the constrained problem unconstrained. Then we find the first order conditions as usual.

In this particular example, we can see that if the constraint binds, $Z = 1 - X$. Plug this into the objective, which renders the problem an unconstrained one in just choosing X :

$$\max_X \ln X + \ln(1 - X)$$

The first order condition is:

$$\frac{1}{X} = \frac{1}{1-X} \quad (\text{A.52})$$

Now solve for X :

$$\begin{aligned} \frac{1-X}{X} &= 1 & (\text{A.53}) \\ \frac{1}{X} - 1 &= 1 \\ \frac{1}{X} &= 2 \\ X &= \frac{1}{2} \end{aligned}$$

We can then solve for the optimal value of Z by plugging this back into the constraint:

$$Z = 1 - \frac{1}{2} = \frac{1}{2} \quad (\text{A.54})$$

An alternative way to solve a constrained optimization problem is to use the method of Lagrange multipliers. Let λ be a number which references the value you would place (in terms of the objective function) on being able to “relax” the constraint (i.e. making the right hand side of the inequality bigger than 1). The Lagrangian is:

$$\mathbb{L} = \ln X + \ln Z + \lambda(1 - X - Z) \quad (\text{A.55})$$

The Lagrangian is the objective function ($\ln X + \ln Z$) plus λ times the “big” side of the weak inequality minus the “small” side (where “big” refers to the “greater than or equal to” side and “small” refers to the “less than or equal to” side). Take the derivatives with respect to X , Z , and λ :

$$\begin{aligned} \frac{\partial \mathbb{L}}{\partial X} &= \frac{1}{X} - \lambda & (\text{A.56}) \\ \frac{\partial \mathbb{L}}{\partial Z} &= \frac{1}{Z} - \lambda \\ \frac{\partial \mathbb{L}}{\partial \lambda} &= 1 - X - Z \end{aligned}$$

The derivative with respect to the λ just gives you back the constraint. At an optimum,

all of these conditions must be equal to zero. This gives us two equations in two unknowns:

$$\begin{aligned}\frac{1}{X} &= \frac{1}{Z} \\ 1 &= X + Z\end{aligned}\tag{A.57}$$

The first condition tells us that $X = Z$. But if $X = Z$, the second condition tells us that $X = Z = \frac{1}{2}$. This is exactly the same solution we got using the method of substituting the constraint into the objective function. The method of Lagrange multipliers is most useful in situations where the constraint may not bind (which would mean $\lambda = 0$). We will not be dealing with such cases, but the two methodologies will yield the same answers, as we will see in the example below.

Example

Consider a simple consumer optimization problem. A household can consume two goods, X and Z . She gets utility from those two goods, but faces a constraint that her expenditure on those two goods cannot exceed her income. The problem is:

$$\begin{aligned}\max_{X,Z} \quad & U = \ln X + Z \\ \text{s.t.} \quad & \end{aligned}$$

$$P_X X + P_Z Z \leq Y$$

Here P_X and P_Z are the prices of each good, and Y is income available (which is taken as exogenous). $\ln X + Z$ is the utility function. Solve for Z in terms of X :

$$Z = \frac{Y - P_X X}{P_Z}\tag{A.58}$$

Plug this into the objective function, rendering this an unconstrained problem:

$$\max_X U = \ln X + \frac{Y - P_X X}{P_Z}$$

The first order condition is:

$$\frac{1}{X} = \frac{P_X}{P_Z} \quad (\text{A.59})$$

To see how one can characterize this optimum using a Lagrangian, set up the Lagrangian:

$$\mathbb{L} = \ln X + Z + \lambda(Y - P_X X - P_Z Z) \quad (\text{A.60})$$

The first order conditions are:

$$\frac{\partial \mathbb{L}}{\partial X} = \frac{1}{X} - \lambda P_X = 0 \quad (\text{A.61})$$

$$\frac{\partial \mathbb{L}}{\partial Z} = 1 - \lambda P_Z = 0 \quad (\text{A.62})$$

Solving the second first order condition for λ yields:

$$\lambda = \frac{1}{P_Z} \quad (\text{A.63})$$

Plugging this in to the first order condition for X yields:

$$\frac{1}{X} = \frac{P_X}{P_Z} \quad (\text{A.64})$$

This is the same as (A.59), which was obtained simply assuming that the constraint holds with equality. This condition has a popular name in economics. It is a “MRS = price ratio” condition, where MRS stands for the marginal rate of substitution. The marginal rate of substitution is equal to the ratio of marginal utilities of two goods. In this case, the marginal utility of X is $\frac{\partial U}{\partial X} = \frac{1}{X}$ and the marginal utility of Z is $\frac{\partial U}{\partial Z} = 1$. Then the MRS is $\frac{\partial U}{\partial X} / \frac{\partial U}{\partial Z} = \frac{1}{X}$. The price ratio is simply the ratio of prices of the two goods. We can use (A.59) to solve for X :

$$X = \frac{P_Z}{P_X} \quad (\text{A.65})$$

Now plug this into the budget constraint to solve for Z :

$$P_Z + P_Z Z = Y$$

$$Z = \frac{Y}{P_Z} - 1 \quad (\text{A.66})$$

(A.65) and (A.66) give us the demand functions for X and Z . The demand for X is decreasing in its own price and increasing in the price of Z . It does not depend on how much income the household has. The demand for Z is decreasing in its own price and increasing in income. That X does not depend on income is not a general result but rather results because we have assumed a special kind of utility function here called quasilinear utility.

Exercises

- Express the following equations as log-linear functions, i.e. take logs and simplify.
 - $Y = zK^\alpha N^{1-\alpha}$.
 - $Z = ce^{rt}\beta K$.
- Calculate the first and second derivative of the following functions:
 - $f(c) = \ln c$.
 - $u(c) = \frac{c^{1-\sigma}}{1-\sigma}$.
 - $h(w) = (-6w^3 + 17w - 4)^\beta - \ln(\theta w^\beta)$.
- Calculate all the first, second, and cross derivatives of the following functions:
 - $F(K, N) = \theta K^\alpha N^{1-\alpha}$.
 - $F(K, N) = \ln \theta + \alpha \ln K + (1 - \alpha) \ln N$.
 - $F(Z, X) = \theta Z^\beta X^\gamma$.
- Solve the following constrained maximization problem. Hint: Argue the constraint binds and then substitute the constraint into the objective function. First find the optimality conditions. Then plug those optimality conditions back into the constraint, expressing x , w , and z as functions of parameters.

$$\max_{x,w,z} U = \alpha \ln(x) + \beta \ln(w) + (1 - \alpha - \beta) \ln(z)$$

subject to

$$p_x x + p_w w + p_z z \leq y.$$

5. Consider an individual who receives utility from consumption, c , and leisure, l . The individual has \bar{L} time to allocate to work, n , and leisure. The individual's consumption is a function of how much he works. In particular, $c = \sqrt{n}$. The individual's maximization problem is

$$\max_{c,l,n} U = \ln(c) + \theta l$$

subject to

$$c = \sqrt{n}$$

$$n + l = \bar{L}$$

where $\theta > 0$. Solve the maximization problem. Hint: Substitute both constraints into the objective function.

6. Evaluate:

(a) $\sum_{j=0}^3 2^j$.

(b) $\sum_{j=0}^3 j^2$.

(c) $\sum_{j=1}^5 (2j - 3)$.

(d) $\sum_{j=1}^{1000} 5$.

7. Show that:

(a) $\frac{\sum_i (X_i + Y_i) + \sum_i X_i - \sum_i Y_i}{\sum_i X_i} = 2$.

(b) $\frac{\sum_i (X_i^2 + 2X_i Y_i + Y_i^2) - \sum_i (X_i^2 - 2X_i Y_i + Y_i^2)}{\sum_i 8X_i Y_i} = \frac{1}{2}$.

Appendix B

Probability and Statistics Appendix

An important feature of modern economics is the comparison of models to data. To make these comparisons it is important to know some basic statistics. It is also useful to know some rules of probability when dealing with decision-making under uncertainty. This appendix reviews some basic statistical and probabilistic concepts and definitions.

B.1 Measures of Central Tendency: Mean, Median, Mode

The mean, median, and mode are different ways of describing what is usually referred to as a measure of *central tendency* of a distribution of a variable. That is, they reflect the typical values a variable takes.

The mean (arithmetic mean to be more accurate) is usually calculated as the sum of the values divided by the total number of values. In terms of notation, the population mean is usually denoted by μ while the sample mean is denoted by \bar{x} (the sample is just a subset of the total population). Suppose we have a variable x for which we have N observations, which corresponds to the entire population. Therefore, x_i represents observation i for $i = 1, 2, \dots, N$. The average for x is calculated as,

$$\mu = \frac{\sum_{i=1}^N x_i}{N}. \quad (\text{B.1})$$

If we have a population of 7 observations ($N=7$) given by: 8, 6, 15, 14, 13, 48, and 8, the mean can be calculated as:

$$\begin{aligned} \mu &= \frac{8 + 6 + 15 + 14 + 13 + 48 + 8}{7} \\ &= 16. \end{aligned}$$

As you may realize, a limitation of the mean as a measure of of central tendency is that it is sensitive to outliers, i.e. a value that differs greatly from the others. Suppose for instance we have a sample with the annual income of 100 individuals, 99 of whom have an income that varies between \$40,000 and \$80,000. The 100th, however, has an income of \$500,000. Clearly, if we use the mean, the income of the typical household would be significantly over-estimated.

In our previous example, we can see that most values are very close to each other, with the exception of 48. If we are only looking at one specific measure of the distribution, we need to make sure the value obtained (16, in the case of the mean) is not reflecting the one that is very distinct and higher than the rest (48, in the example).

The median, the value such that half of the observations are above and half of the observations are below, is not affected by outliers. Obtaining the median is simple. We first order observations from the smallest to the largest value. Again, with our previous example the ordering would be: 6, 8, 8, 13, 14, 15, and 48. Since we have an odd number of observations, the median is just the middle value: 13. Note that half of the values are above 13 and half of the values are below it. Note that the value obtained here is below the value obtained for the mean. As we mentioned, the median is not affected by outliers. Since 48 is a value significantly above the other ones, it was expected that the value of the median is lower. Obviously, when we have millions of observations, what is ‘expected’ is not so clear. Now, if we had an odd number of observations, the median is calculated by taken the average of the two middle observations. For instance, if our set of data was composed by 6, 8, 8, 13, 14, 15, 23, and 48. The median would be calculated as $(13+14)/2 = 13.5$.

Finally, the mode is the most commonly observed value within our set. In the previous case, that would be 8. As you may be wondering, nothing prevents us from having a distribution that has more than one mode, i.e. a distribution in which there is two or more most commonly observed values. For instance, if we had 6, 8, 8, 13, 14, 15, 15, and 48, the mode would be 8 *and* 15. We refer this as a multimodal distribution and, more specifically, bimodal.

B.2 Expected Value

Expected value is closely related to the mean. Formally, the expected value of a random variable is the probability-weighted arithmetic mean. Let us be concrete by offering an example. Suppose that a random variable X can take on three values – $X = 1$, $X = 3$, and $X = 11$. We sometimes refer to these three different possible realizations as “states of nature,” or just “states” for short. Suppose that the probability of these three states occurring are $p_1 = \frac{1}{3}$, $p_2 = \frac{1}{2}$, and $p_3 = 1 - p_1 - p_2 = \frac{1}{6}$. Note that probabilities must sum to one – some state of nature must occur. The expected value of X , which we shall denote with $\mathbb{E}[\cdot]$, is:

$$\mathbb{E}[X] = p_1 \times 1 + p_2 \times 3 + p_3 \times 11 = \frac{11}{3} = 3.6667 \quad (\text{B.2})$$

More generally, suppose that X can take on N different discrete values. Index these realizations by $i = 1, \dots, N$, and suppose that the probability of each realization is given by

p_i , where $\sum_{i=1}^N p_i = 1$. Then the expected value is:

$$\mathbb{E}[X] = \sum_{i=1}^N p_i X_i \quad (\text{B.3})$$

Note that the expected value of X is in general *not* the simple arithmetic mean of the possible realizations of X . In the example used above, the arithmetic mean of all possible realizations is 5. It is important to weight potential realizations by their probability of occurring.

However, the arithmetic mean of a *sample* of realizations of a random variable ought to correspond to its expected value in a large enough sample. Suppose that you are a statistician and observe a time series of X , denote the realizations by X_t , for $t = 0, \dots, T$. If T is sufficiently big, the arithmetic average of X_t , i.e. $\frac{\sum_{t=0}^T x_t}{T+1}$, should correspond to the expected value of X . This is because one should observe fewer realizations of 11, in the example considered above, than the other two realizations given the assumed probability structure. In essence, the frequency of observations in a random sample does the probability weighting for you, and the arithmetic mean of a random sample (provided that sample is sufficiently large) corresponds to the expected value of the random variable.

There are a couple of useful properties of expected value. We will illustrate these in the context of the example considered above. First, expected value is a linear operator, which means that the expected value of a linear transformation of the series equals the transformation of the expected value of the series. Suppose that we consider multiplying all possible realizations of X by a constant parameter, call it a . Suppose that $a = 3$. Then the expected value is:

$$\mathbb{E}[aX] = p_1 \times a + p_2 \times 3a + p_3 \times 11a = a(p_1 + p_2 \times 3 + p_3 \times 11) = a \mathbb{E}[X] = 11 \quad (\text{B.4})$$

Alternatively, suppose that you consider subtracting (or adding) a constant to each possible realization of X . In particular, we are interested in $\mathbb{E}[X - a]$. In this particular example, we would have:

$$\begin{aligned} \mathbb{E}[X - a] &= p_1 \times (1 - a) + p_2 \times (3 - a) + p_3 \times (11 - a) = \\ & p_1 + p_2 \times 3 + p_3 \times 11 - a(p_1 + p_2 + p_3) = \mathbb{E}[X] - a = \frac{2}{3} \end{aligned} \quad (\text{B.5})$$

Since expected value is a linear operator, the expected value of a non-linear transformation

of a random variable is in general *not* equal to the non-linear transformation of the expected value; i.e. $E[f(X)] \neq f(E[X])$. Suppose that we are interested in computing the expected value of $\frac{1}{X}$. We would have:

$$\mathbb{E}\left[\frac{1}{X}\right] = p_1 \times \frac{1}{1} + p_2 \times \frac{1}{3} + p_3 \times \frac{1}{11} = 0.5152 \quad (\text{B.6})$$

In contrast, note that the inverse of the expected value of X is $\frac{1}{\mathbb{E}[X]} = 0.2727$. This fact of expectations operators comes in handy when thinking about precautionary saving, for example.

Lastly, suppose that we have two random variables. Let these variables be Z and Y . To make things a little cleaner, suppose that each series can only take on two discrete values. Because it is a linear transformation, for example the expected value of the sum (or difference) of Z and Y would equal the sum (or difference) of the expected values, i.e. $\mathbb{E}[Z + Y] = \mathbb{E}[Z] + \mathbb{E}[Y]$. But suppose, instead, that we are interested in a non-linear transformation, such as the expected value of the product, $\mathbb{E}[ZY]$. In general, $\mathbb{E}[ZY] \neq \mathbb{E}[Z]\mathbb{E}[Y]$. This would be true if the series were *independent*, but not in general.

Suppose, as an example, that Z and Y are independent. Z can take on values of 2 or 4, with probabilities $p_1 = \frac{1}{2}$ and $p_2 = 1 - p_1 = \frac{1}{2}$ being the probabilities of these two states being realized. Y can take on two values, 0 or 3, with probabilities $q_1 = \frac{2}{3}$ and $q_2 = \frac{1}{3}$, respectively. The expected value of Z is just $\mathbb{E}[Z] = 3$, while the expected value of Y is $\mathbb{E}[Y] = 1$. The product of expectations, $\mathbb{E}[Z]\mathbb{E}[Y]$, is 3. But what about the expected value of the production, i.e. $\mathbb{E}[ZY]$? With two possible states of nature for two different random variables, there are in essence four joint possible states of nature – Z could be 2 and Y could be 0, Z could be 2 and Y could be 3, Z could be 4 and Y could be 0, or Z could be 4 and Y could be 3. If the realizations of Z and Y are independent, then the probabilities of these states occurring is simply the product of the expectations. Hence, we would have:

$$\mathbb{E}[ZY] = p_1q_1 \times (2 \times 0) + p_1q_2 \times (2 \times 3) + p_2q_1 \times (4 \times 0) + p_2q_2 \times (4 \times 3) = 3 \quad (\text{B.7})$$

For this particular example, the expected value of the product is equal to the product of the expected values. But what if, in contrast, the series are not independent? In particular, suppose that Z is more likely to be high when Z is high and vice-versa. Here, we need to discuss *conditional* probabilities. Let $Pr(Y | Z)$ denote the probability of a particular realization of Y *given* a particular realization of Z . Suppose that Z can again take on two values of 2 or 4, each with probability of $\frac{1}{2}$. Y can again take on two values of 0 or 3. But suppose that Y is *more* likely to be high when Z is high and *more* likely to be comparatively

low when Z is low. Suppose that Y equals 3 with probability $\frac{2}{3}$ when $Z = 4$ and 0 with probability $\frac{1}{3}$ when $Z = 2$. Assume that $Y = 0$ with probability 1 when $Z = 2$. Formally, this means we are assuming $Pr(Y = 3 | X = 4) = \frac{2}{3}$ and $Pr(Y = 3 | X = 2) = 0$. This means that the probabilities of the four states occurring are as follows. $Z = 2$ and $Y = 0$ with probability $\frac{1}{2} \times 1$, $Z = 2$ and $Y = 3$ with probability $\frac{1}{2} \times 0$, $Z = 4$ and $Y = 3$ with probability $\frac{1}{2} \times \frac{2}{3}$, and $Z = 4$ and $Y = 0$ with probability $\frac{1}{2} \times \frac{1}{3}$. Note that the probabilities of the four states occurring sum to 1. The expected value of Z is again just 2. The expected value of Y is somewhat more complicated, because we need to condition on Z . In particular, we have:

$$\mathbb{E}[Y] = \frac{1}{2} (1 \times 0 + 0 \times 3) + \frac{1}{2} \left(\frac{2}{3} \times 3 + \frac{1}{3} \times 0 \right) = 1 \quad (\text{B.8})$$

In other words, the expected value of Y is probability $Z = 2$ times the sum of probability-weighted realizations of Y conditional on this plus the probability $Z = 4$ times the sum of probability-weighted realizations of Y conditional on this. The expected value of Y for this particular example again works out to 1, just as in the case where the realizations of Z and Y were assumed to be independent. But what about the expected value of the product of X and Y ? In this example, this is given by:

$$\mathbb{E}[ZY] = \frac{1}{2} \times 1 \times (2 \times 0) + \frac{1}{2} \times 0 \times (2 \times 3) + \frac{1}{2} \times \frac{1}{3} \times (4 \times 0) + \frac{1}{2} \times \frac{2}{3} \times (4 \times 3) = 4 \quad (\text{B.9})$$

In this example, the expected value of the product (4) is *larger* than the product of expected values (3). As we shall see below, if two random variables covary positively with one another, the expected value of a product will be greater than the product of expectations, while the if they covary negatively with one another, the reverse will be true. To understand what we mean by covary, it is useful to extend the concept of conditional probabilities to conditional expectations. Formally, let $\mathbb{E}[Y | Z]$ denote the expected value of Y conditional on the realization of Z . In the particular example we have been considering, we have $\mathbb{E}[Y | Z = 2] = 0$, while $\mathbb{E}[Y | Z = 4] = 2$. If the conditional expectations of Y are different than the *unconditional* expectation (which we calculated above and which in this example is just 1), then Y and Z covary with one another. Evidently they covary positively with one another since the expectation of Y conditional on Z being high is larger than the unconditional expectation of Y (and vice-versa conditioning on Z being low).

B.3 Measures of Dispersion: Variance and Standard Deviation

As useful as the measures of central tendency are, they provide an incomplete picture of the distribution. For instance, knowing that the GDP per capita in the U.S. is \$51,000 just tells you the *average* income. Some individuals have income well above the average while others have income that is significantly below the average. If we are interested in what the distribution of income looks like, then the mean and the median provide little information. We need a measure of *dispersion* that tells us how dispersed, or spread out, the observations are.

A simple way of capturing dispersion would be to calculate the average “distance” each realization of a random variable is from its mean. One could measure “distance” by the absolute value of the difference between the realization of a random variable and its mean. A downside of this approach is that it places equal weight on realizations near the mean as those far from the mean. An alternative to using absolute value to measure distance is to measure distance with *squared* deviations from the mean. This is what economists do when we calculate variance. Formally, the variance of a random variable is the expected value of squared deviations of a random variable from its mean. Formally:

$$\text{var}(X) = \mathbb{E}[X - \mathbb{E}[X]]^2 \quad (\text{B.10})$$

Note that we can equivalently write (B.10) as:

$$\text{var}(X) = \mathbb{E}\left[X^2 + \mathbb{E}[X]^2 - 2X\mathbb{E}[X]\right] \quad (\text{B.11})$$

We can distribute the outer expectation operator as:

$$\text{var}(X) = \mathbb{E}[X^2] + \mathbb{E}[\mathbb{E}[X]^2] - \mathbb{E}[2X\mathbb{E}[X]] \quad (\text{B.12})$$

In simplifying (B.12), note that the expected value of an expected value is just the expected value. For example, there is no uncertainty over what $\mathbb{E}[X]^2$ is; hence, $\mathbb{E}[\mathbb{E}[X]^2] = \mathbb{E}[X^2]$. Furthermore, since there is no uncertainty over $\mathbb{E}[X]$, we can write the last term in (B.12) as $\mathbb{E}[X]\mathbb{E}[2X] = 2\mathbb{E}[X]^2$ – in other words, we can take the $\mathbb{E}[X]$ inside the outer expectations operator outside of that expectations operator. Making use of this, we can write (B.12) as:

$$\text{var}(X) = \mathbb{E}[X^2] - \mathbb{E}[X]^2 \quad (\text{B.13})$$

Let us work with one of the examples used above. Suppose that X can take on three values – 1, 3, and 11 – with probability $\frac{1}{3}$, $\frac{1}{2}$, and $\frac{1}{6}$. The expected value is $\frac{11}{3}$, or approximately 3.67.

The variance can be calculate as the probability-weighted sum of squared deviations from the mean, or:

$$var(X) = \frac{1}{3} \left(1 - \frac{11}{3}\right)^2 + \frac{1}{2} \left(3 - \frac{11}{3}\right)^2 + \frac{1}{6} \left(11 - \frac{11}{3}\right)^2 = 11.56 \quad (\text{B.14})$$

A difficulty in interpreting the variance is that it is expressed in *squared* units of the mean of a series. An easier metric to interpret is called the standard deviation, and is simply the square root of the variance. In particular:

$$sd(X) = \sqrt{var(X)} \quad (\text{B.15})$$

In the example above, the standard deviation of the random variable X would be 3.39. To interpret this statistic, it means that, on average, X is 3.39 units away from its mean. It is common to use the standard deviation as a measure of *volatility* (in a time series context, i.e. how much does a series tend to move around over time) and a measure of *dispersion* (in a cross-sectional context, i.e. how different do individuals on average look from one another at a point in time).

There are a couple of useful properties of variance. First, the variance of a constant times a random variable is the constant squared times the variance of the random variable. In particular:

$$var(aX) = a^2 var(X) \quad (\text{B.16})$$

The standard deviation of a constant times a random variable is just the constant times the standard deviation of the variable:

$$sd(a) = a sd(X) \quad (\text{B.17})$$

The variance of a constant plus a random variable is just the variance of the random variable:

$$var(X + a) = var(X) \quad (\text{B.18})$$

(B.18) turns out to be a special case of a formula relating variance and covariance of sums of random variables, which we discuss further in the section below.

We can see clearly from (B.17) something that was mentioned above – the units of the variance are squared units of the mean, while units of the standard deviation are simply units of the mean. These units are controlled by the constant a . For series with different means, it is difficult to compare volatilities of series by comparing standard deviations. For example,

the standard deviation of X in the example above is 3.39. But the standard deviation of $2X$ would be 6.78. $2X$ would appear more volatile than X , but this appearance is illusory because the series have different means. One way to deal with this issue is to compute what is called the coefficient of variation, or cv . The coefficient of variation is defined as the ratio of the standard deviation of a random variable to its mean. The coefficient of variation of X above is 0.92545 (i.e. $3.39/3.67$). The coefficient of variation of $2X$ is also 0.92545 (i.e. $7.68/(22/3)$). Computing coefficients of variation allows one to compare volatilities of series with different means.

Another way to compare volatilities of series with potentially different means is to instead compute the variance / standard deviation of the natural log of a series. In particular:

$$var(\ln X) = \mathbb{E}[\ln X - \mathbb{E}[\ln X]]^2 \quad (\text{B.19})$$

In looking at (B.19), note that $\mathbb{E}[\ln X] \neq \ln \mathbb{E}[X]$ (see the discussion on expected value above). Why is it that computing standard deviations of logs can deal with the problem of series have different means? As noted in Appendix A, the difference in logs is approximately the percentage difference between the values of the variable. In terms of (B.19), $\ln X - \mathbb{E}[\ln X]$ is approximately the percentage difference of X about its mean. Percentages are, by construction, unitless. We can see why this works using the example considered above. In particular, the $var(\ln 2X) = var(\ln X + \ln 2) = var(\ln X)$ (making use of (B.18)). In other words, the variance of the log of a series is independent of how that series is scaled (i.e. what its mean is). As long as a variable cannot go negative (meaning that one can in fact take the natural log of the series), macroeconomists almost exclusively focus on measures of volatility/dispersion based on natural logs of a series rather than using the coefficient of variation.

As defined, the variance and standard deviation are properties of distributions of a random variable. It is also possible to compute *sample* variances and standard deviations. As above, let μ be the sample mean. Suppose that one observes T different observations. Then the sample variance is:

$$\sigma^2 = \frac{\sum_{i=1}^T (X_i - \mu)^2}{T} \quad (\text{B.20})$$

The sample variance is just the arithmetic average of squared deviations about the sample mean. In a sufficiently large sample, this ought to correspond to the population variance, similar to how the sample mean ought to correspond to the expected value of a series in a sufficiently big sample of data. The sample standard deviation is typically denoted σ and is simply the square root of the sample variance.

B.4 Measures of Association: Covariance and Correlation

In discussing expectations above, we referred to how two series covary with one another. In this section we formalize this concept and introduce the concepts of covariance and correlations as measures of association between two different random variables.

Formally, suppose that one has two random variables, X and Y . The covariance is defined as:

$$\text{cov}(X, Y) = \mathbb{E}[(X - \mathbb{E}[X])(Y - \mathbb{E}[Y])] \quad (\text{B.21})$$

In other words, the covariance between two series is the expected value of the product of deviations about the mean. Note that if $X = Y$, then (B.21) collapses to the general formula for variance, (B.10). It is a measure of association between two series and conveys information about how series are associated with one another. If it is positive, it means that one series being above its average value means that, on average, the other series will also be above its mean. Note that one can write (B.21) as:

$$\text{cov}(X, Y) = \mathbb{E}[XY - \mathbb{E}[X]Y + \mathbb{E}[X]\mathbb{E}[Y] - X\mathbb{E}[Y]] \quad (\text{B.22})$$

The outer expectation operator in (B.22) can be distributed as follows:

$$\text{cov}(X, Y) = \mathbb{E}[XY] - \mathbb{E}[X]\mathbb{E}[Y] + \mathbb{E}[X]\mathbb{E}[Y] - \mathbb{E}[X]\mathbb{E}[Y] \quad (\text{B.23})$$

To do this, we are making use of two rules. One was documented above, and this is that the expected value of a sum is the sum of expected values. The other rule hinges on the fact that $\mathbb{E}[X]$ and $\mathbb{E}[Y]$ are known – there is no uncertainty over these expectations, and thus they are in essence constants. Thus, $\mathbb{E}[\mathbb{E}[X]Y] = \mathbb{E}[X]\mathbb{E}[Y]$ – i.e. the $\mathbb{E}[X]$ can be taken “outside” the outer expectations operator since it is a constant. Simplifying (B.23), we get:

$$\text{cov}(X, Y) = \mathbb{E}[XY] - \mathbb{E}[X]\mathbb{E}[Y] \quad (\text{B.24})$$

(B.24) can be re-written as follows:

$$\mathbb{E}[XY] = \mathbb{E}[X]\mathbb{E}[Y] + \text{cov}(X, Y) \quad (\text{B.25})$$

In other words, (B.25) tells us that the expected value of a product is equal to the product of the expected values plus a covariance term. If this covariance term is 0, then the expected value of a product equals the product of the expectations. If two series co-vary positively, the expected value of the product will be greater than product of expectations. To see

this concretely, return to the example considered about with Z and Y . Z can take on two values, each with probability $\frac{1}{2}$. Let these two values be 2 and 4; hence, the expected value is $\mathbb{E}[Z] = 3$. Suppose that Y can also take on two values. Y equals 3 with probability $\frac{2}{3}$ when $Z = 4$ and 0 with probability $\frac{1}{3}$ when $Z = 2$. $Y = 0$ with probability 1 when $Z = 2$. As documented above, the unconditional expectation of Y is $\mathbb{E}[Y] = 1$. What is the covariance between these two series? We can have $Z = 2$ and $Y = 0$ with probability $\frac{1}{2}$, $Z = 4$ and $Y = 3$ with probability $\frac{1}{2} \cdot \frac{2}{3} = \frac{1}{3}$, and $Z = 4$ with $Y = 0$ with probability $\frac{1}{2} \cdot \frac{1}{3} = \frac{1}{6}$. Hence, the covariance is:

$$\text{cov}(Z, Y) = \frac{1}{2}(2 - 3)(0 - 1) + \frac{1}{3}(4 - 3)(3 - 1) + \frac{1}{6}(4 - 3)(0 - 1) = 1 \quad (\text{B.26})$$

For this particular example, the covariance between Z and Y works out to 1. Note this covariance is consistent with (B.25) given that $\mathbb{E}[XY] = 4$ while $\mathbb{E}[X]\mathbb{E}[Y] = 3$.

We can use the formula relating covariance, the expectation of a product, and the product of an expectation, i.e. (B.24), to derive an expression for the variance of a sum of two random variables. In particular, suppose that we are interested in the variance of $X + Y$. This can be written:

$$\text{var}(X + Y) = \mathbb{E} \left[X + Y - \mathbb{E}[X] - \mathbb{E}[Y] \right]^2 \quad (\text{B.27})$$

Working this out in long hand, we get:

$$\begin{aligned} \text{var}(X + Y) = & \mathbb{E} \left[X^2 + XY - X\mathbb{E}[X] - X\mathbb{E}[Y] + XY + Y^2 - Y\mathbb{E}[X] - Y\mathbb{E}[Y] \right. \\ & \left. - \mathbb{E}[X]X - \mathbb{E}[X]Y + \mathbb{E}[X]^2 + \mathbb{E}[X]\mathbb{E}[Y] - \mathbb{E}[Y]X - Y\mathbb{E}[Y] + \mathbb{E}[Y]\mathbb{E}[X] + \mathbb{E}[Y]^2 \right] \quad (\text{B.28}) \end{aligned}$$

(B.28) may be simplified:

$$\begin{aligned} \text{var}(X + Y) = & \mathbb{E} \left[X^2 + Y^2 + \mathbb{E}[X]^2 + \mathbb{E}[Y]^2 + 2XY \right. \\ & \left. - 2X\mathbb{E}[X] - 2Y\mathbb{E}[Y] - 2X\mathbb{E}[Y] - 2Y\mathbb{E}[X] \right] \quad (\text{B.29}) \end{aligned}$$

We can now distribute the outer expectation operator, again making use of the fact repeatedly that $\mathbb{E}[\mathbb{E}[X]Y] = \mathbb{E}[X]\mathbb{E}[Y]$ (i.e. the “inner” expectation operator can be moved outside the outer expectation operator). Doing so, we get:

$$\text{var}(X + Y) = \mathbb{E}[X^2] - \mathbb{E}[X]^2 + \mathbb{E}[Y^2] - \mathbb{E}[Y]^2 + 2\mathbb{E}[XY] - 2\mathbb{E}[X]\mathbb{E}[Y] \quad (\text{B.30})$$

Using (B.13), we can write (B.30) as:

$$\text{var}(X + Y) = \text{var}(X) + \text{var}(Y) + 2(\mathbb{E}[XY] - \mathbb{E}[X]\mathbb{E}[Y]) \quad (\text{B.31})$$

Now, using (B.25), we may write (B.31) as:

$$\text{var}(X + Y) = \text{var}(X) + \text{var}(Y) + 2\text{cov}(X, Y) \quad (\text{B.32})$$

In words, (B.32) says that the variance of a sum equals the sum of variances plus two times the covariance between two variables. The result given above that $\text{var}(X + a) = \text{var}(X)$ follows from this. If a is a constant, its variance is zero and its covariance with X is also zero. Hence, (B.18) is just a special case of (B.32).

The sign of a covariance conveys information about whether two series tend to move together (positive covariance), opposite one another (negative covariance), or are unrelated (zero covariance). But it is difficult to interpret magnitudes of a covariance. Similar to issues with variances and standard deviations, the covariance depends upon the means of the series under consideration. For this reason, it is common to instead measure the association between two series using the correlation coefficient. The correlation coefficient is defined as the ratio of the covariance between X and Y divided by the product of the standard deviations of X and Y . In particular:

$$\text{corr}(X, Y) = \frac{\text{cov}(X, Y)}{\text{sd}(X)\text{sd}(Y)} \quad (\text{B.33})$$

The correlation coefficient is constructed to lie between -1 and 1. A correlation of 0 means the series exhibit no (linear) relationship to one another and the covariance is zero. If two series are identical, then $\text{cov}(X, Y) = \text{var}(X)$ and $\text{sd}(X)\text{sd}(Y) = \text{var}(X)$, so the correlation coefficient is 1. Series that co-move negatively have a negative correlation. The strength of co-movement between two series is measured by how close the correlation is to 1 (or -1, in the case of negatively correlated variables). The correlation coefficient is scale invariant. One can show that, for two constants a and b , $\text{cov}(aX, bY) = ab \times \text{cov}(X, Y)$. Similarly, the standard deviations of these constant times the random variables are $\text{sd}(aX) = a\text{sd}(X)$ and $\text{sd}(bY) = b\text{sd}(Y)$. Hence, the correlation between aX and bY is invariant to the values of a and b .

As with variances and means, it is possible to construct sample equivalents of covariances

and correlation coefficients given a sample of observed data. Let μ_X and μ_Y denote the sample arithmetic means of X and Y , and σ_X and σ_Y denote the sample standard deviations (all defined above). Then the sample covariance is:

$$\widehat{cov}(X, Y) = \frac{\sum_{i=1}^T (X_i - \mu_X)(Y_i - \mu_Y)}{T} \quad (\text{B.34})$$

The “hat” appears atop the covariance operator in (B.34) to refer to the fact that it is an estimated measure of covariance based on an observed sample of data. The sample correlation coefficient is typically denoted via $\rho(X, Y)$ and is defined similarly to (B.33):

$$\rho(X, Y) = \frac{\widehat{cov}(X, Y)}{\sigma_X \sigma_Y} \quad (\text{B.35})$$

Appendix C

The Neoclassical Model with an Upward-Sloping Y^s Curve

In the main text, we make an assumption on preferences that allows us to write the labor supply curve as a function only of the real wage, w_t , and an exogenous variable which may be interpreted as an exogenous shock to preferences. This variable is called θ_t . Formally, the kind of preference specification needed to motivate such a specification in a micro-founded model is based on [Greenwood, Hercowitz, and Huffman \(1988\)](#).

Other specifications of preferences, in contrast, make labor supply considerably more complicated. In particular, there may be an *intertemporal* dimension to labor supply. Labor supply may be a function of the real interest rate, r_t . For example, suppose that r_t increases. A higher r_t , other things being equal, likely means that a household would like to increase its saving (we say “likely” because this conclusion rests on another assumption that the substitution effect dominates the income effect in terms of consumption). In a model where income is exogenous, increasing saving requires reducing consumption. But if the household can influence its income through an endogenous labor supply choice, if it wants to increase its saving in response to an increase in r_t it stands to reason that it may wish to increase its labor supply.

This appendix explores the ways in which allowing for this possibility impacts the graphical presentation of the neoclassical model. We also look at how exogenous shocks might have different effects on endogenous variables. In a nutshell, allowing for an intertemporal dimension of labor supply results in the Y^s curve being upward-sloping rather than vertical. This allows *IS* shocks to have effects on output even in the neoclassical model, and results in supply shocks having *smaller* effects on output than they would in the world where the Y^s curve is instead vertical. The graphical presentation here with an upward-sloping Y^s curve is very similar to the real intertemporal model in [Williamson \(2014\)](#).

We prefer the presentation in the text with a vertical Y^s curve for a couple of reasons. First, it greatly simplifies the analysis – one needn’t worry about secondary effects in the labor market and it removes some ambiguities related to how different exogenous shocks impact endogenous variables. Second, it seems plausible to us that labor supply is only

very weakly impacted by the real interest rate. As such, the Y^s curve is likely quite steep. Therefore, the assumptions giving rise to a vertical Y^s curve do not seem to be too unrealistic. Third, the assumption of a vertical Y^s greatly simplifies the analysis of the New Keynesian model. If shocks to the IS curve may impact Y_t^f , then *both* AD and AS curves will shift in response to these shocks. This does not fundamentally change much but significantly complicates the analysis.

C.1 The Neoclassical Model with an Intertemporal Dimension to Labor Supply

The equations characterizing the equilibrium of the neoclassical model are *identical* to what is presented in Chapter 17 with the exception of the labor supply function. These are presented below for completeness:

$$C_t = C^d(Y_t - G_t, Y_{t+1} - G_{t+1}, r_t) \quad (\text{C.1})$$

$$N_t = N^s(w_t, \theta_t, r_t) \quad (\text{C.2})$$

$$N_t = N^d(w_t, A_t, K_t) \quad (\text{C.3})$$

$$I_t = I^d(r_t, A_{t+1}, K_t) \quad (\text{C.4})$$

$$Y_t = A_t F(K_t, N_t) \quad (\text{C.5})$$

$$Y_t = C_t + I_t + G_t \quad (\text{C.6})$$

$$M_t = P_t M^d(r_t + \pi_{t+1}^e, Y_t) \quad (\text{C.7})$$

$$r_t = i_t - \pi_{t+1}^e \quad (\text{C.8})$$

The only difference relative to our earlier presentation involves (C.2), which features an argument related to the real interest rate. For the purposes of this appendix we assume that the partial derivative with respect to the real interest rate here is positive, $\frac{\partial N^s(\cdot)}{\partial r_t} > 0$, whereas in our standard treatment in the main body of the text we (implicitly) assume that this partial derivative is zero. Our alternative assumption in this appendix reflects the reasonable idea that a household wishing to save more due to a higher interest rate will both consume less and work more.

The demand side of the economy is *identical* to what is presented in the main text and is not repeated here. The IS curve can be used to graphically summarize (C.1), (C.4), and (C.6). Money will still be neutral and the classical dichotomy will still hold; hence, we can analyze (C.7)-(C.8) *after* determining the equilibrium values of real endogenous variables. What will

be different is the supply side of the economy. Intuitively, there will be a relationship between r_t and Y_t on the supply side – a higher r_t will stimulate labor supply, which results in more N_t and hence more Y_t .

Figure C.1 graphically derives the Y^s curve under these assumptions. Start with a particular value of the real interest rate, call it $r_{0,t}$. Given θ_t , this determines the position of the labor supply curve (upper left plot). Find the level of labor input consistent with being on both the labor demand and supply curves. Call this $N_{0,t}$. Plug this into the production (lower left plot). This gives a value of output, call it $Y_{0,t}$. Reflect this onto the horizontal axis (lower right plot), and this gives a you a pair, $(r_{0,t}, Y_{0,t})$, consistent with (C.2), (C.3), and (C.5) all holding.

Figure C.1: The Y^s Curve: Derivation with Intertemporal Labor Supply

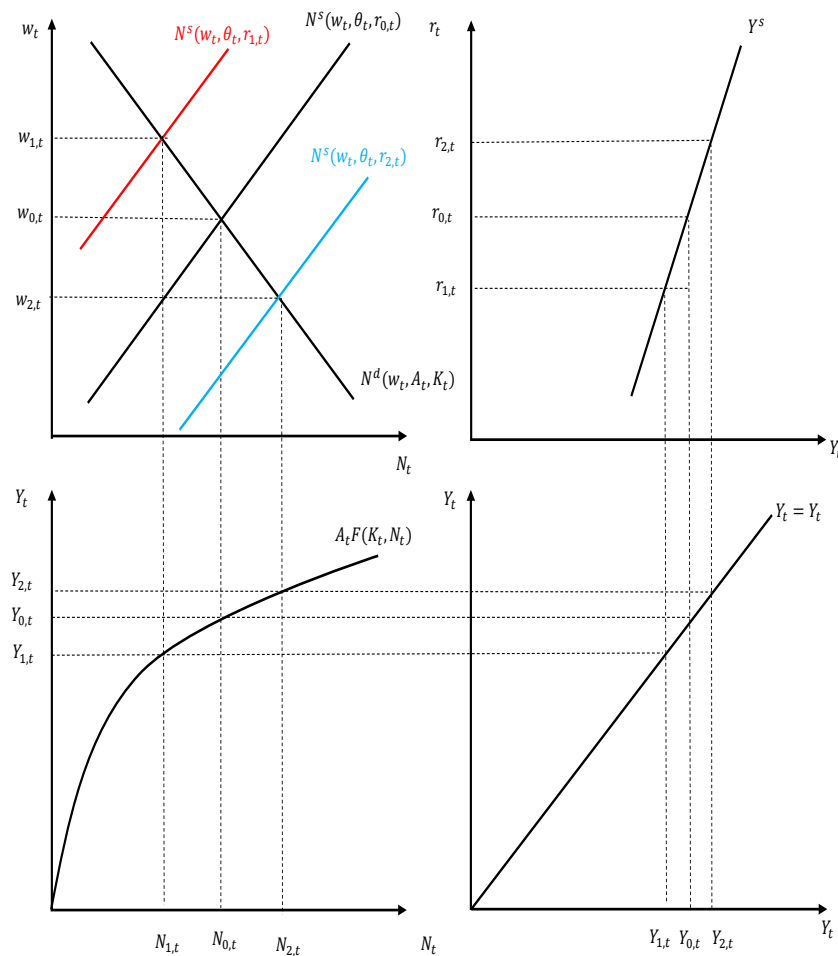

One can consider higher or lower values of the real interest rate. A higher value results in the labor supply curve shifting out, which results in more labor input and hence more output. A lower real interest rate causes the labor supply curve to shift left, which has the

opposite effect on labor input and output. Connecting the dots in the upper right plot, we get an *upward-sloping* Y^s curve. A higher value of r_t is associated with a larger value of Y_t because of the effect of r_t on labor supply. Note that the Y^s curve is nevertheless fairly steep. One could of course draw things differently, but to get the Y^s curve far from vertical one would need the labor supply curve to shift quite significantly with the real interest rate.

The full equilibrium of the real side of the model can be characterized graphically as in Figure C.2 using the same five part graph as in the main text. The only difference is that the Y^s curve is upward-sloping rather than vertical.

Figure C.2: $IS - Y^s$ Equilibrium with Upward-Sloping Y^s Curve

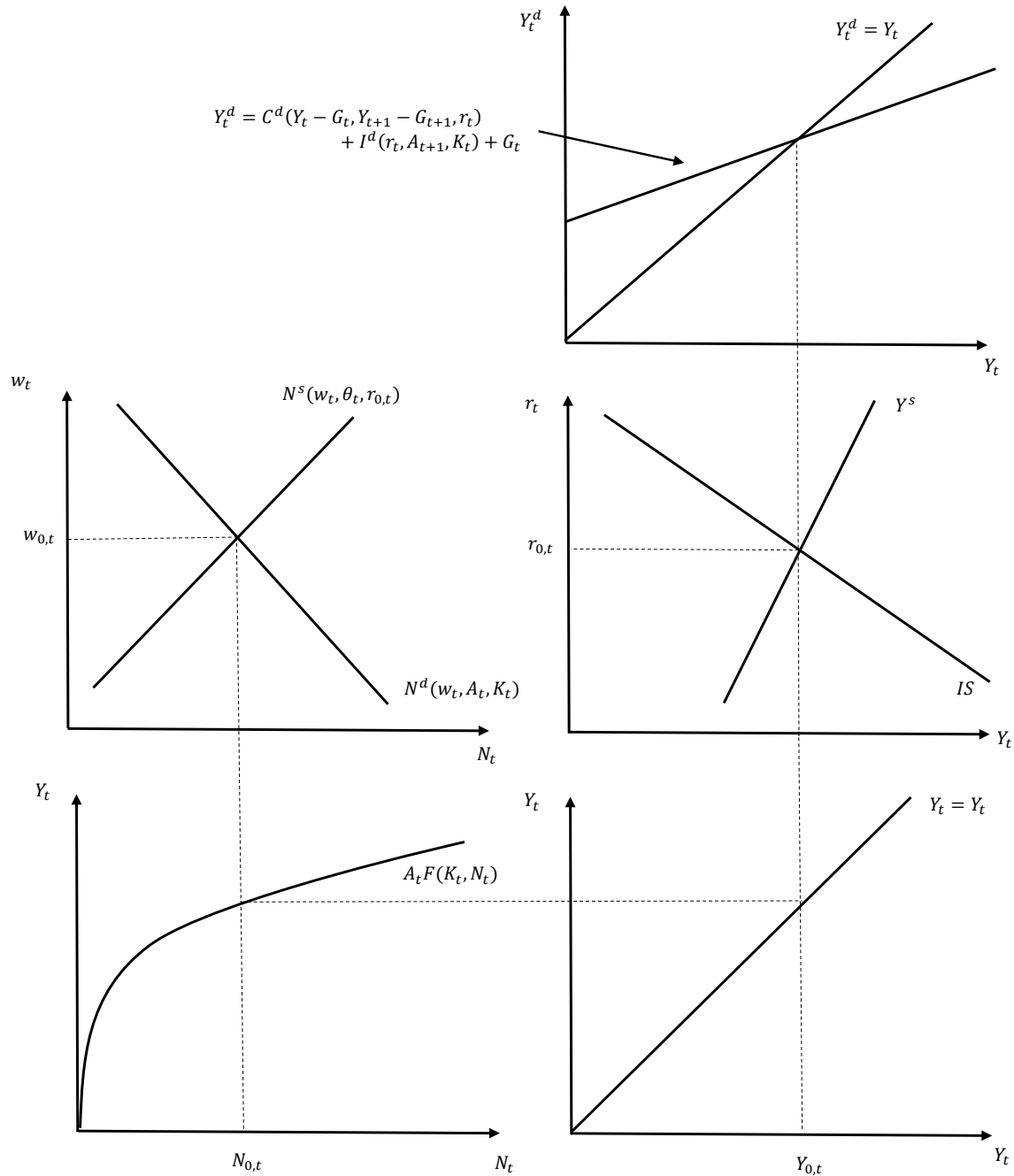

As noted above, the classical dichotomy continues to hold and nominal endogenous variables may be determined *after* real endogenous variables. We can do so using the same money demand-supply graph as in the main text, shown below in Figure C.3. Given values of r_t and Y_t (determined at the intersection of the IS and Y^s curves), the position of the (upward-sloping) money demand curve is determined. The P_t where this intersects the

(vertical) money supply curve is the equilibrium price level.

Figure C.3: Equilibrium in the Money Market

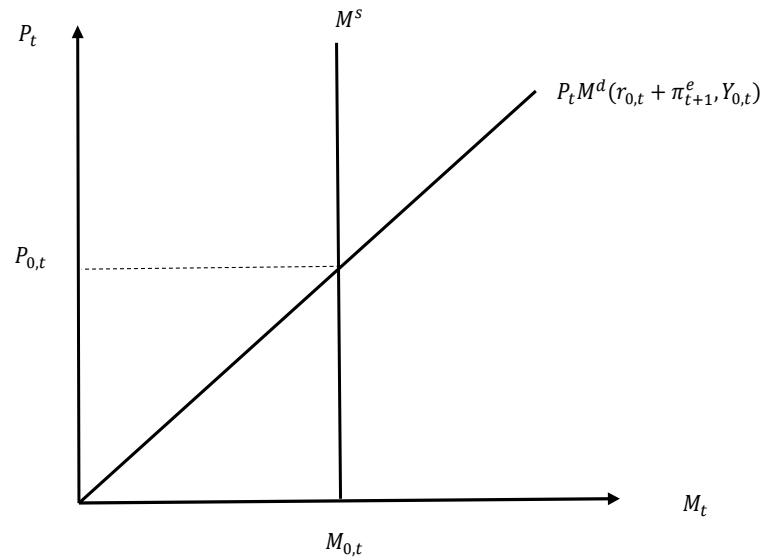

C.2 Effects of Shocks with Upward-Sloping Y^s

We are now in a position to analyze the effects of changes in different exogenous variables on the endogenous variables of the model. In the process, we can examine how the results compare to the model presented in the main text where the Y^s curve is vertical.

Consider first an exogenous increase in A_t . These effects are shown in Figure C.4. In terms of how the Y^s curve shifts, things work out exactly as in the text. Holding the real interest rate fixed, labor demand shifts right and the production function shifts up. With higher N_t and higher A_t , Y_t is higher for a given r_t . As a consequence, the Y^s curve shifts horizontally to the right. Because the horizontal shift is derived holding r_t fixed, the horizontal shift of the Y^s curve here is exactly the same as presented in the text when the Y^s curve is vertical.

The rightward shift of the Y^s curve causes Y_t to rise and r_t to fall. The lower r_t stimulates autonomous expenditure (consumption and investment are both higher) so that the expenditure line shifts up in the upper right graph (shown in green). What is different relative to the version of the model with a vertical Y^s curve is that output increases *by less* than the horizontal shift of the Y^s curve, and consequently r_t falls by less than it would in that model. Furthermore, there is a secondary effect in the labor market that must be taken into account. The lower r_t causes the labor supply curve to shift in. This inward shift of labor supply is the reason why output increases by less than the horizontal shift of the Y^s curve – in equilibrium, N_t goes up by less when r_t changes than if r_t is held fixed. The

equilibrium quantity of labor input must be consistent with the equilibrium level of output. The real wage is higher in equilibrium.

Figure C.4: Increase in A_t with Upward-Sloping Y^s Curve

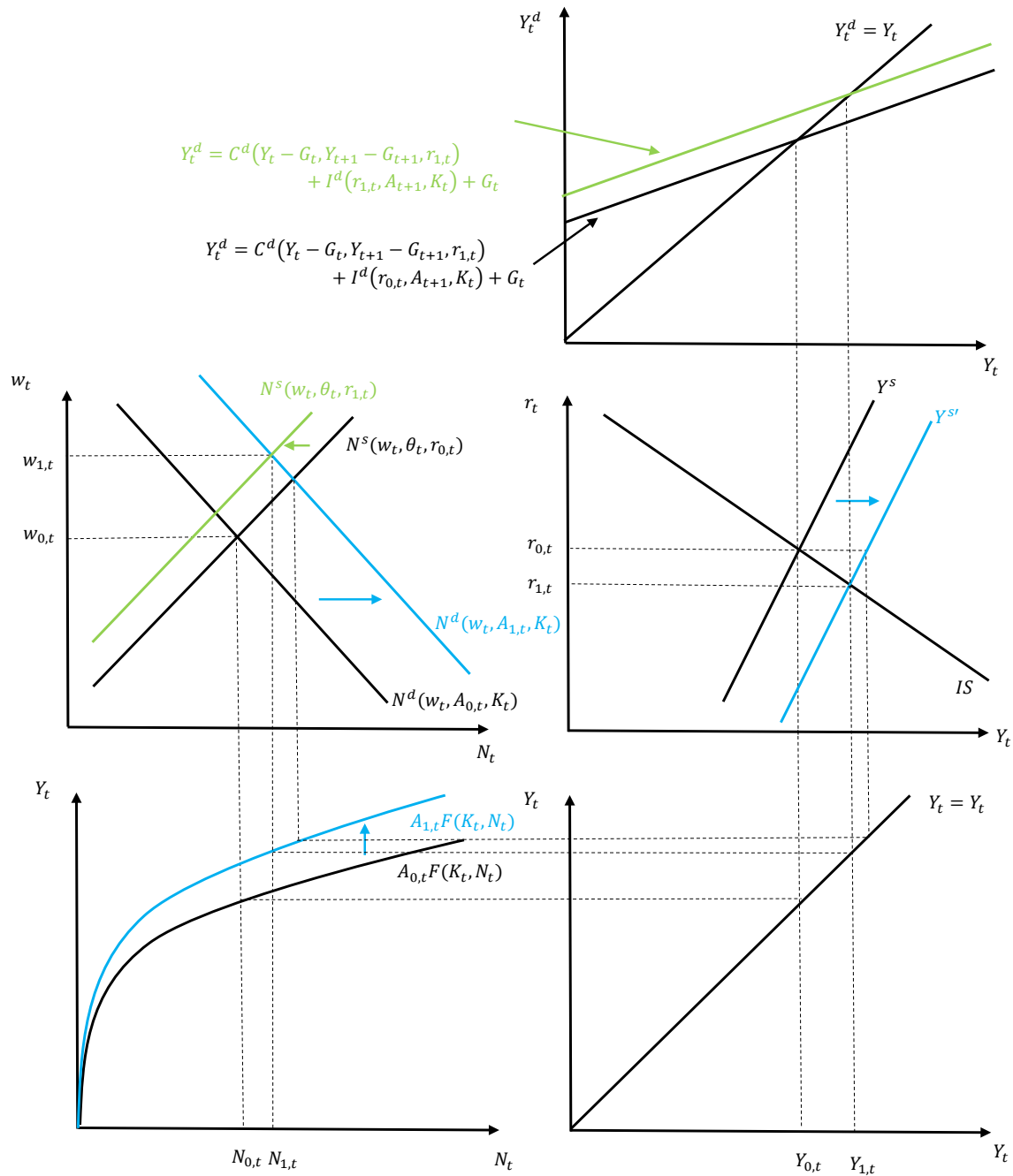

Relative to the version of the model with a vertical Y^s curve presented in the main text, in this version of the model output increases by *less*, the real interest rate falls by *less*, the real wage rises by *more*, and labor input rises by *less*. Indeed, it is conceivable that N_t could

actually *fall* when A_t increases. For this to happen, the Y^s curve would have to be sufficiently flat (i.e. labor supply would have to be quite sensitive to the real interest rate). This is not how we have drawn the figure (which shows N_t rising); but even if it rises, labor input nevertheless rises by less than it would if the Y^s curve were vertical.

The effect of higher A_t on the price level is qualitatively the same as it is the version of the model with a vertical Y^s curve. A lower r_t and higher Y_t both work to stimulate money demand (i.e. the money demand curve pivots to the right). This means that P_t must fall (equivalently, the price of money in terms of goods, $\frac{1}{P_t}$, must rise). This is shown in Figure C.5.

Figure C.5: Increase in A_t : the Money Market

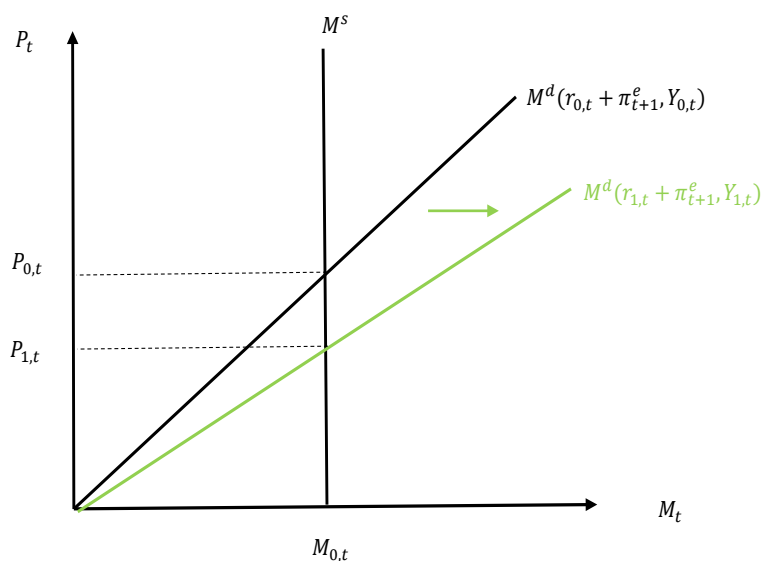

Consider next a shock which causes the IS curve to shift to the right. In Figure C.6, we consider an increase in government spending, G_t , though qualitatively the diagram would be the same for an increase in A_{t+1} or a decrease in G_{t+1} . The rightward shift of the IS curve along an upward-sloping Y^s curve results in r_t rising and Y_t rising. The increase in Y_t is different relative to the version of the model considered in class. The mechanism through which output increases is that the higher r_t causes the labor supply curve to shift to the right, which results in w_t falling and N_t rising. The higher r_t works in the opposite direction of the exogenous impetus to desired expenditure (in this example, an increase in G_t), but it does not completely offset it. This is shown in green in the upper right plot. How C_t and I_t react depends on the exact exogenous shock causing the IS curve to shift. In the case of an increase in G_t , they both must decline in equilibrium. Y_t increases by *less* than G_t (recall from the text that the horizontal shift of the IS curve is the change in G_t , and since

Y_t increases by less than the horizontal shift of the IS curve in equilibrium $Y_t - G_t$ is lower) and r_t increases, both of which work to reduce C_t . A higher r_t works to reduce I_t .

Figure C.6: Positive IS Shock with Upward-Sloping Y^s Curve

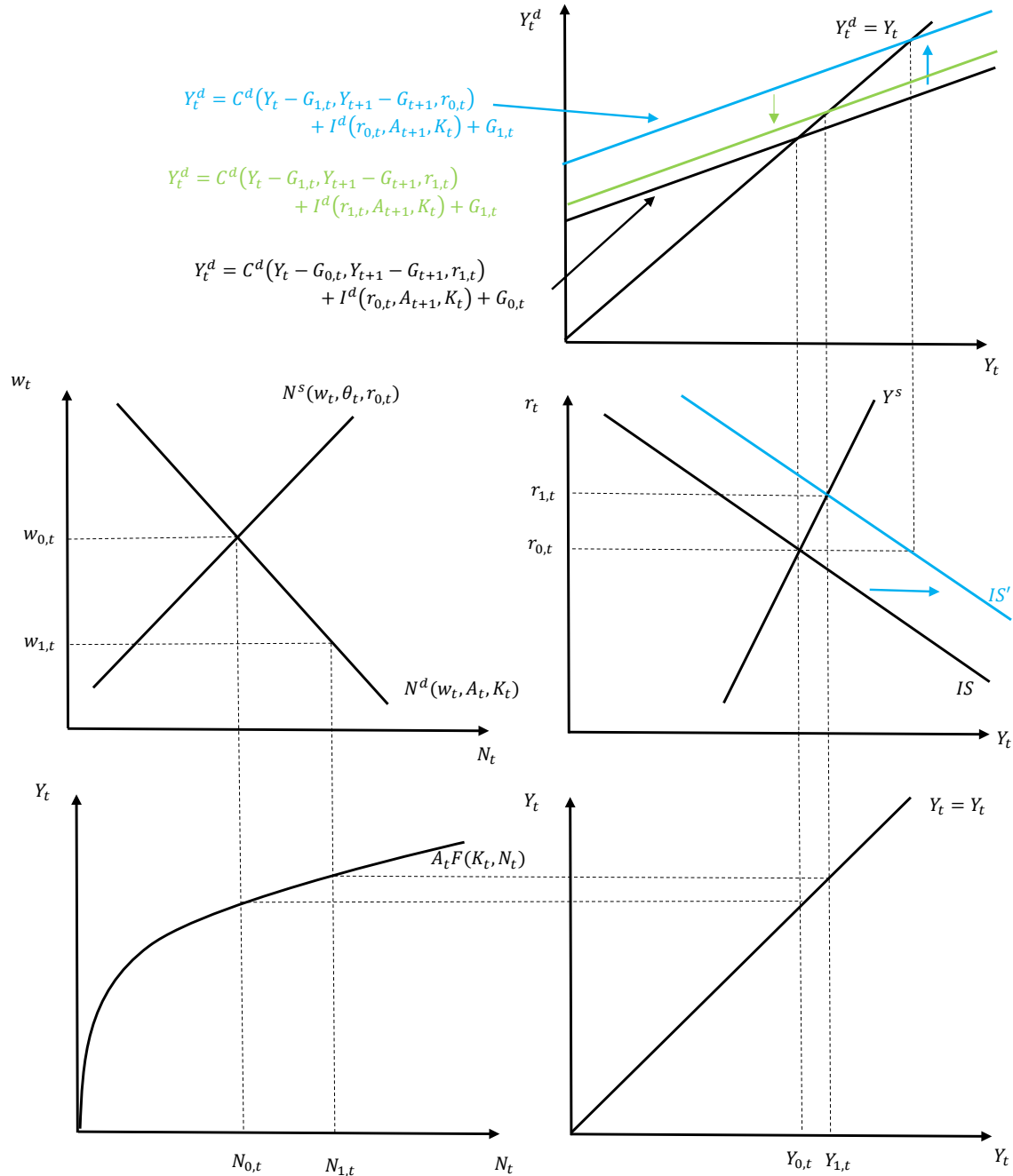

Without additional assumptions, it is not possible to say definitively what ought to happen to P_t in response to a positive IS shock. On the one hand, Y_t is higher, which stimulates the demand for money and would put downward pressure on the price level. But on the other

hand, r_t is higher, which depresses the demand for money and puts upward pressure on the price level. Which effect dominates is not clear, and so Figure C.7 is drawn with a “?” to denote this ambiguity.

Figure C.7: Positive *IS* Shock: the Money Market

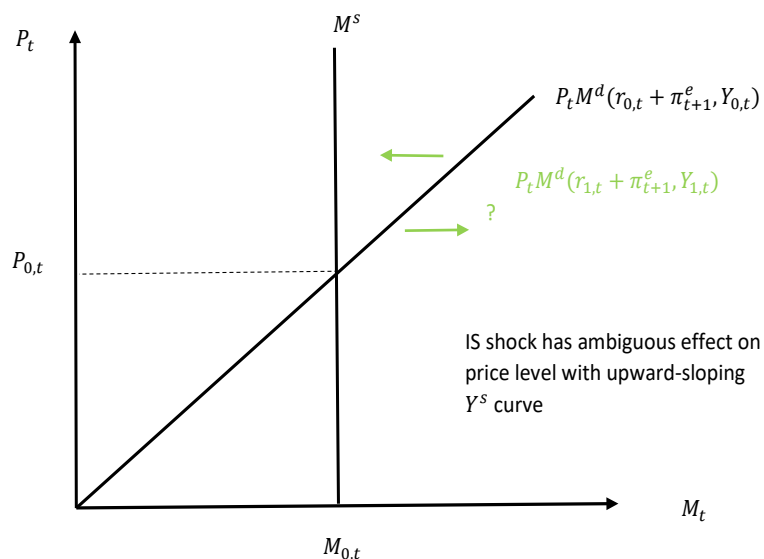

C.3 Sources of Output Fluctuations with an Upward-Sloping Y^s Curve

In the text we argued that the neoclassical / real business cycle model relies on *supply* shocks to be the main drivers of output in order to be at all consistent with known facts from the data. In the version of the model considered in the text, this conclusion is not particularly deep – with a vertical Y^s curve, *only* supply shocks can impact output.

But what if the Y^s curve is instead upward-sloping? Since *IS* shocks can impact equilibrium output in this specification of the model, does this open the door to demand-driven theories of output fluctuations even within the confines of the neoclassical model? The answer turns out to be no. It is true that an upward-sloping Y^s curve permits demand shocks to have effects on output. But there are several problems as pertain the data. First, it is unlikely that the Y^s curve is very flat (i.e. that labor supply is highly sensitive to the real interest rate). This means it would require extremely large shocks to the *IS* curve to generate reasonably-sized output fluctuations. Second, as shown above in Figure C.6, conditional on *IS* shocks the real wage is *countercyclical* in the neoclassical model. In contrast, in the data the real wage is moderately procyclical, probably even moreso than conventional measures of the real wage would indicate (in particular, recall the discussion on the “composition bias”

in Chapter 19). Third, in the data consumption, investment, and output are all strongly positively correlated with one another. *IS* shocks will typically result in either C_t and I_t moving opposite Y_t (e.g. in response to an increase in G_t) or C_t and I_t moving opposite one another (e.g. this is what would happen conditional on anticipated changes in future government spending). This *co-movement* problem means that even if one entertains an upward-sloping Y^s curve, for the neoclassical model to produce quantitatively reasonable co-movements among endogenous variables it must be predominantly driven by productivity shocks.

Appendix D

The New Keynesian Model with Sticky Wages

In the main text we generate a non-vertical AS curve in the short run by assuming that the price level is sticky (either completely or partially). In this appendix we document how a sticky nominal wage results in a similar non-vertical AS curve. The real wage, w_t , gives the units of goods that a firm must pay the household in exchange for one unit of labor. The nominal wage, W_t , gives the units of money (i.e. dollars) that the firm must pay the household in exchange for one unit of labor. The real and nominal wage are connected via the identity that $w_t = \frac{W_t}{P_t}$. If $W_t = 6$ dollars, and the price of a good in terms of dollars is $P_t = 2$, then one unit of labor costs the firm $6/2 = 3$ goods.

In the sticky wage model, we assume that the nominal wage is set in advance and therefore exogenous and fixed within a period. We denote the exogenous nominal wage as \bar{W}_t . With a fixed nominal wage, it is in general impossible to simultaneously be on the labor demand and supply curves. We assume that the “rules of the game” are as follows. Once \bar{W}_t is set, the household commits to supply as much labor as the firm demands at this nominal wage. This means that the household will not be on its labor supply curve. Relative to the neoclassical model, we replace (24.1) with the condition that $w_t = \frac{\bar{W}_t}{P_t}$, where \bar{W}_t is exogenous. The following equations therefore characterize the supply side of the sticky wage New Keynesian model:

$$w_t = \frac{\bar{W}_t}{P_t} \tag{D.1}$$

$$N_t = N^d(w_t, A_t, K_t) \tag{D.2}$$

$$Y_t = A_t F(K_t, N_t) \tag{D.3}$$

The AS curve is defined as the set of (P_t, Y_t) pairs consistent with these three equations holding. We can derive the AS curve graphically using a four part graph. In the upper left quadrant we plot w_t against N_t . Given \bar{W}_t and P_t , the real wage is determined. Given this real wage, we determine labor input off of the labor demand curve. Given this level of labor input, we determine output from the production function.

Figure D.1: The Sticky Wage AS Curve: Derivation

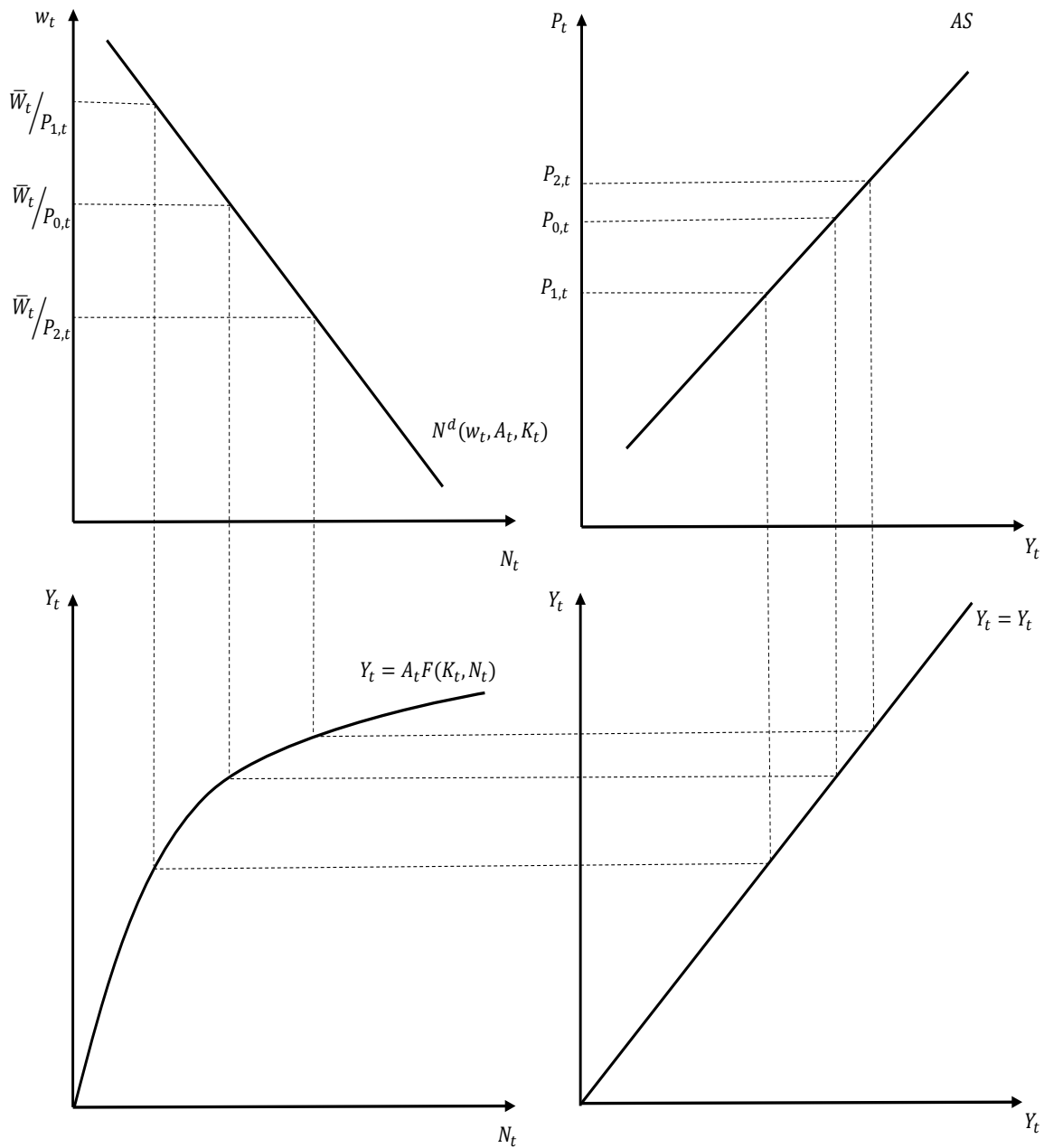
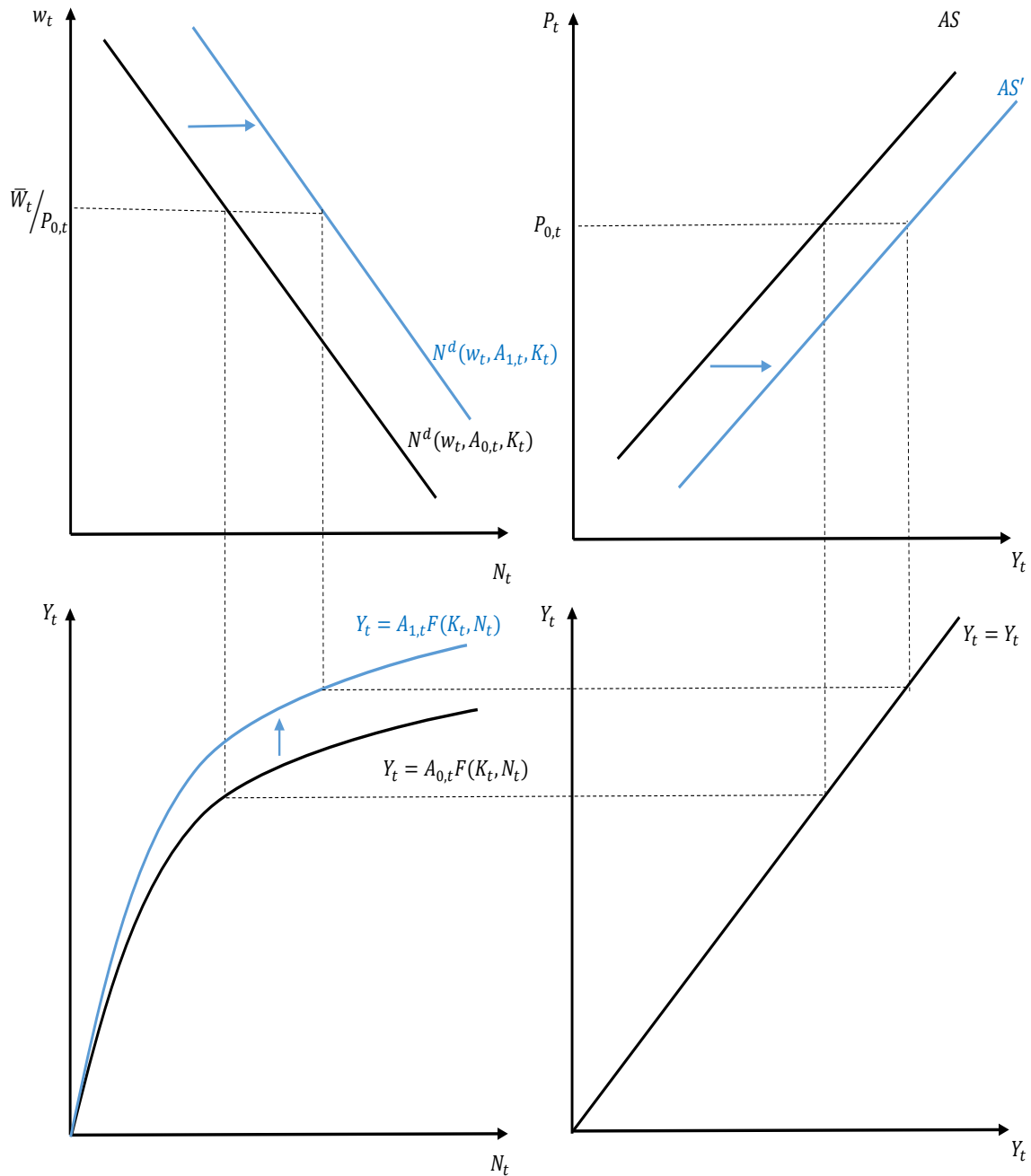

Figure D.1 graphically derives the sticky wage AS curve. Start with a particular price level, $P_{0,t}$. Given the exogenous nominal wage, \bar{W}_t , this determines a real wage, $\frac{\bar{W}_t}{P_{0,t}}$. Given this real wage, we determine labor input from the labor demand curve, $N_{0,t}$. We then evaluate the production function at this level of labor input, giving $Y_{0,t}$. Next, consider a lower price level, $P_{1,t} < P_{0,t}$. This results in a higher real wage. From the labor demand curve, this results

in a lower level of labor input, $N_{1,t}$. The lower labor input results in a lower level of output, $Y_{1,t}$. Next, consider a higher price level, $P_{2,t} > P_{0,t}$. This results in a lower real wage. The lower real wage induces the firm to hire more labor. More labor input results in a higher level of output, $Y_{2,t}$. Connecting these different (P_t, Y_t) pairs yields an upward-sloping AS curve.

The AS curve will shift if exogenous variables relevant for equations (D.1)-(D.3) change. Consider first a change in A_t . This is shown graphically in Figure D.2. A higher A_t shifts the labor demand curve out. Holding the price level fixed at $P_{0,t}$, there is no change in the real wage. With the labor demand curve shifted out, the firm finds it desirable to hire more labor at the fixed real wage. The production function also shifts up. Combining higher labor input with the shifted production function results in a higher level of output for a given price level. Put differently, the AS curve now crosses through a (P_t, Y_t) pair to the right of the original point. In other words, the AS curve shifts out to the right.

Figure D.2: The Sticky Wage AS Curve: Increase in A_t



Note that changes in θ_t will not affect the position of the AS curve in the sticky wage model. This is because θ_t is relevant only for the labor supply curve, and we are not on the labor supply curve in the sticky wage model. There is a new exogenous variable relevant for the position of the AS curve here, and that is \bar{W}_t . Suppose that \bar{W}_t were to increase. Holding the price level fixed at $P_{0,t}$, this would result in a higher real wage. Along the

downward-sloping labor demand curve, this would entail a reduction in labor input, from $N_{0,t}$ to $N_{1,t}$. There is no shift of the production function. Lower labor input, however, means a reduction in output for a given price level. This means that, for a given price level $P_{0,t}$, output will be lower at $Y_{1,t}$. In other words, the AS curve will shift to the left when \bar{W}_t increases.

Figure D.3: The Sticky Wage AS Curve: Increase in \bar{W}_t

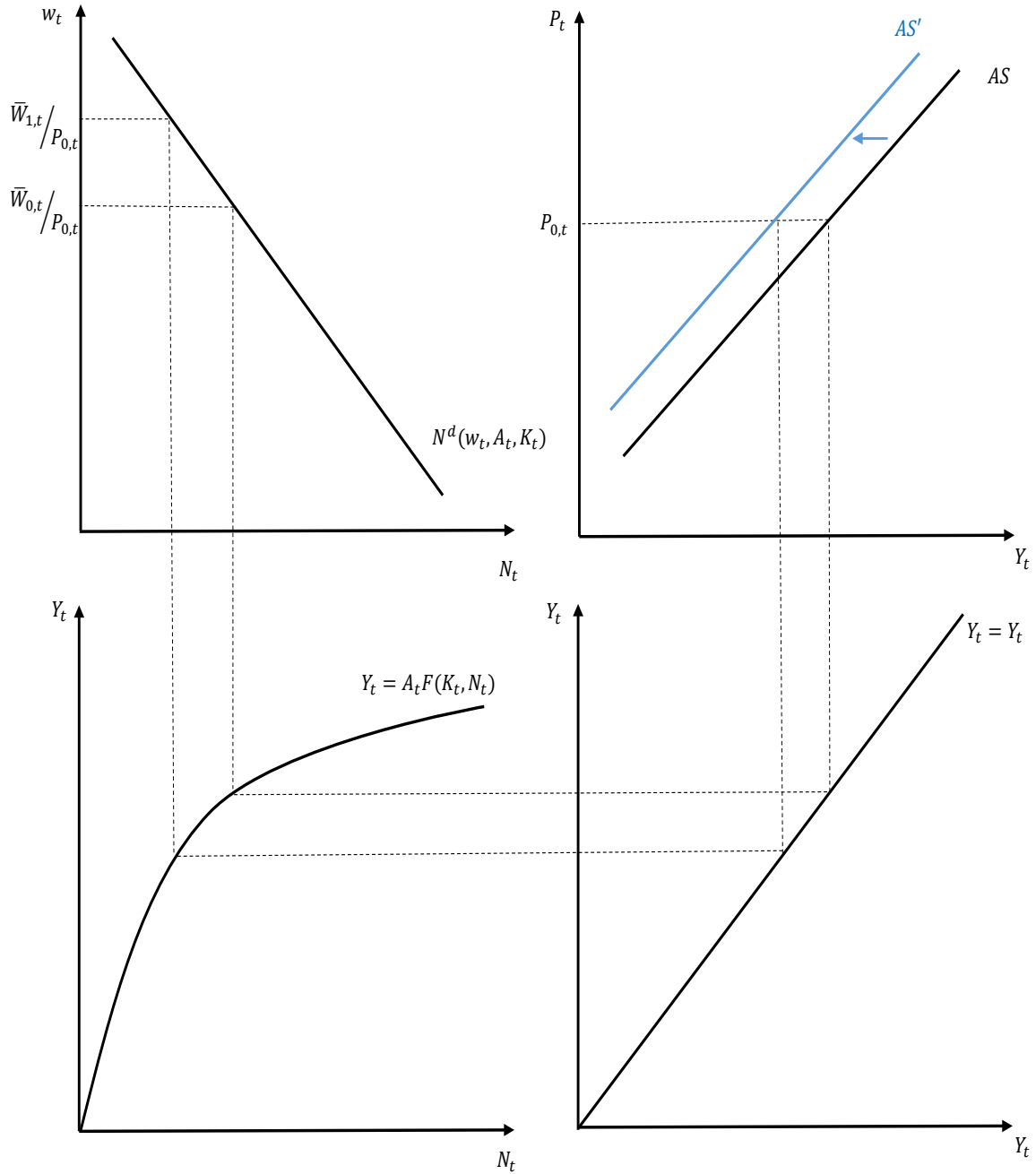

Table D.1 summarizes how the changes in relevant exogenous variables qualitatively shift the sticky wage AS curve.

Table D.1: Sticky Wage AS Curve Shifts

Change in Variable	Direction of Shift of AS
$\uparrow A_t$	Right
$\uparrow \bar{W}_t$	Left
$\uparrow \theta_t$	No Shift

At this point it is useful to compare and contrast the sticky price and sticky wage models. In the sticky price model of the text, we replace labor *demand* with the AS curve that $P_t = \bar{P}_t + \gamma(Y_t - Y_t^f)$. In the sticky wage model presented here, we replace labor *supply* with the condition that $w_t = \frac{\bar{W}_t}{P_t}$, where \bar{W}_t is exogenous. Either setup generates a non-vertical AS curve because higher P_t results in higher Y_t , and thus both versions will allow demand shocks (both real demand shocks to the *IS* curve and monetary shocks) to affect output. But the two models do have different implications for the behavior of the real wage in response to exogenous shocks.

D.1 Equilibrium Effects of Shocks in the Sticky Wage Model

Eight equations characterize the equilibrium of the sticky wage economy. These are shown below:

$$C_t = C^d(Y_t - G_t, Y_{t+1} - G_{t+1}, r_t) \quad (\text{D.4})$$

$$w_t = \frac{\bar{W}_t}{P_t} \quad (\text{D.5})$$

$$N_t = N^d(w_t, A_t, K_t) \quad (\text{D.6})$$

$$I_t = I^d(r_t, A_{t+1}, K_t) \quad (\text{D.7})$$

$$Y_t = A_t F(K_t, N_t) \quad (\text{D.8})$$

$$Y_t = C_t + I_t + G_t \quad (\text{D.9})$$

$$M_t = P_t M^d(r_t + \pi_{t+1}^e, Y_t) \quad (\text{D.10})$$

$$r_t = i_t - \pi_{t+1}^e \quad (\text{D.11})$$

The endogenous variables of the model are Y_t , N_t , C_t , I_t , r_t , i_t , P_t , and w_t . This is eight

endogenous variables (with eight equations). The exogenous variables of the model are A_t , A_{t+1} , G_t , G_{t+1} , M_t , π_{t+1}^e , and \bar{W}_t . We could also consider θ_t to be an exogenous variable, but it will have no effects on the equilibrium of the economy since we are not on the labor supply curve in the sticky wage model. These expressions are identical to the neoclassical model, with the exception of (D.5), which replaces the labor supply curve. The full equilibrium is depicted graphically in Figure D.4:

Figure D.4: Sticky Wage IS-LM-AD-AS Equilibrium

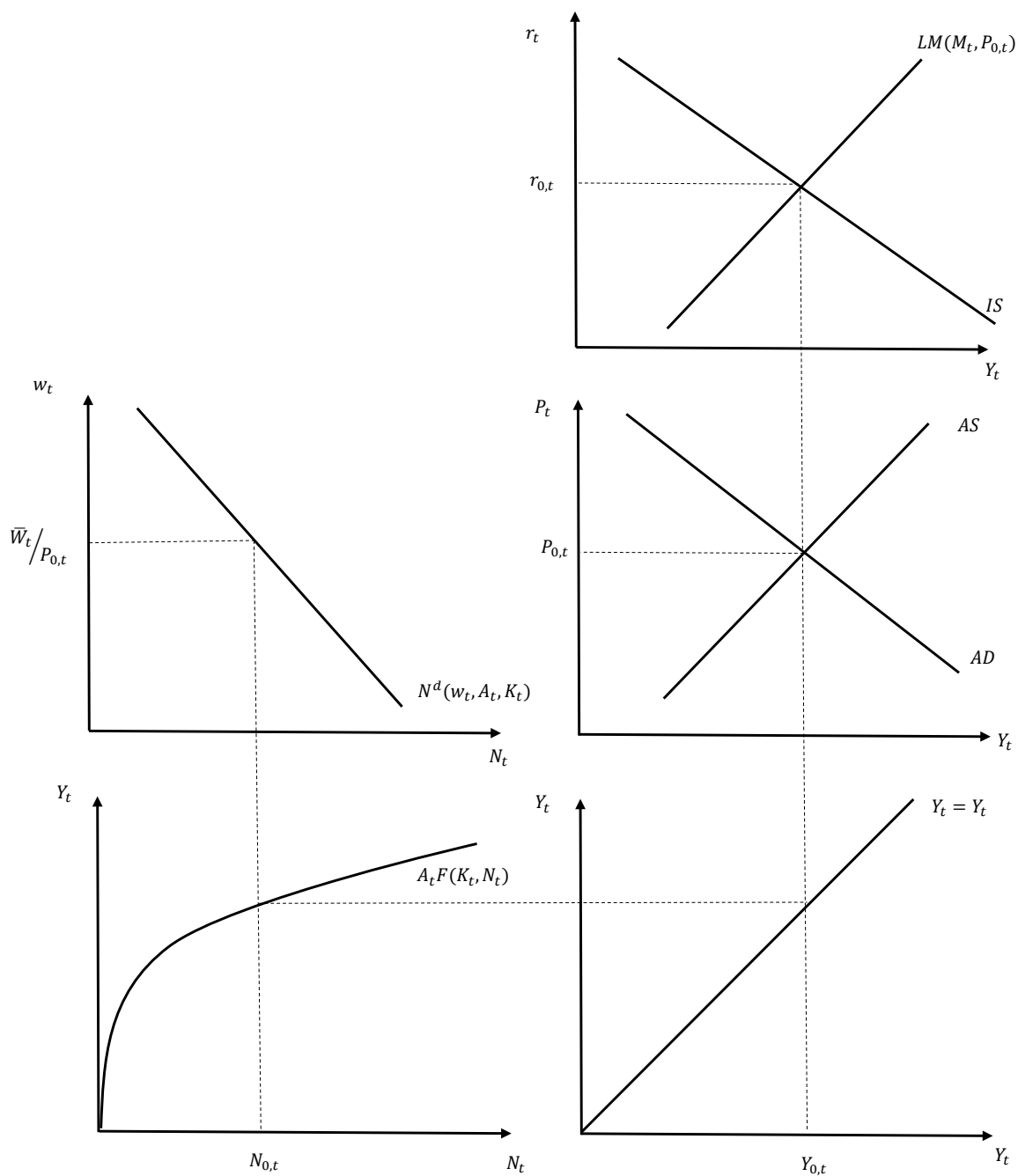

There is a similarity to the sticky price model here in how the equilibrium quantity of labor input is determined, though there are some differences. Output is determined by the joint intersection of the AD and AS curves. The level of labor input must be consistent with this quantity of output. The real wage is read off of the labor demand curve at this level of labor input, instead of the labor supply curve as in the sticky price model.

Now, let us consider changes in different exogenous variables (one at a time) and examine how the equilibrium values of the endogenous variables change. Let's start with an increase in M_t . Suppose that M_t increases from $M_{0,t}$ to $M_{1,t} > M_{0,t}$. Holding the price level fixed, this has the effect of shifting the LM curve out to the right. This is shown in Figure D.5 in blue, with the new LM curve holding the price level fixed labeled $LM(M_{1,t}, P_{0,t})$.

Figure D.5: Effects of Increase in M_t

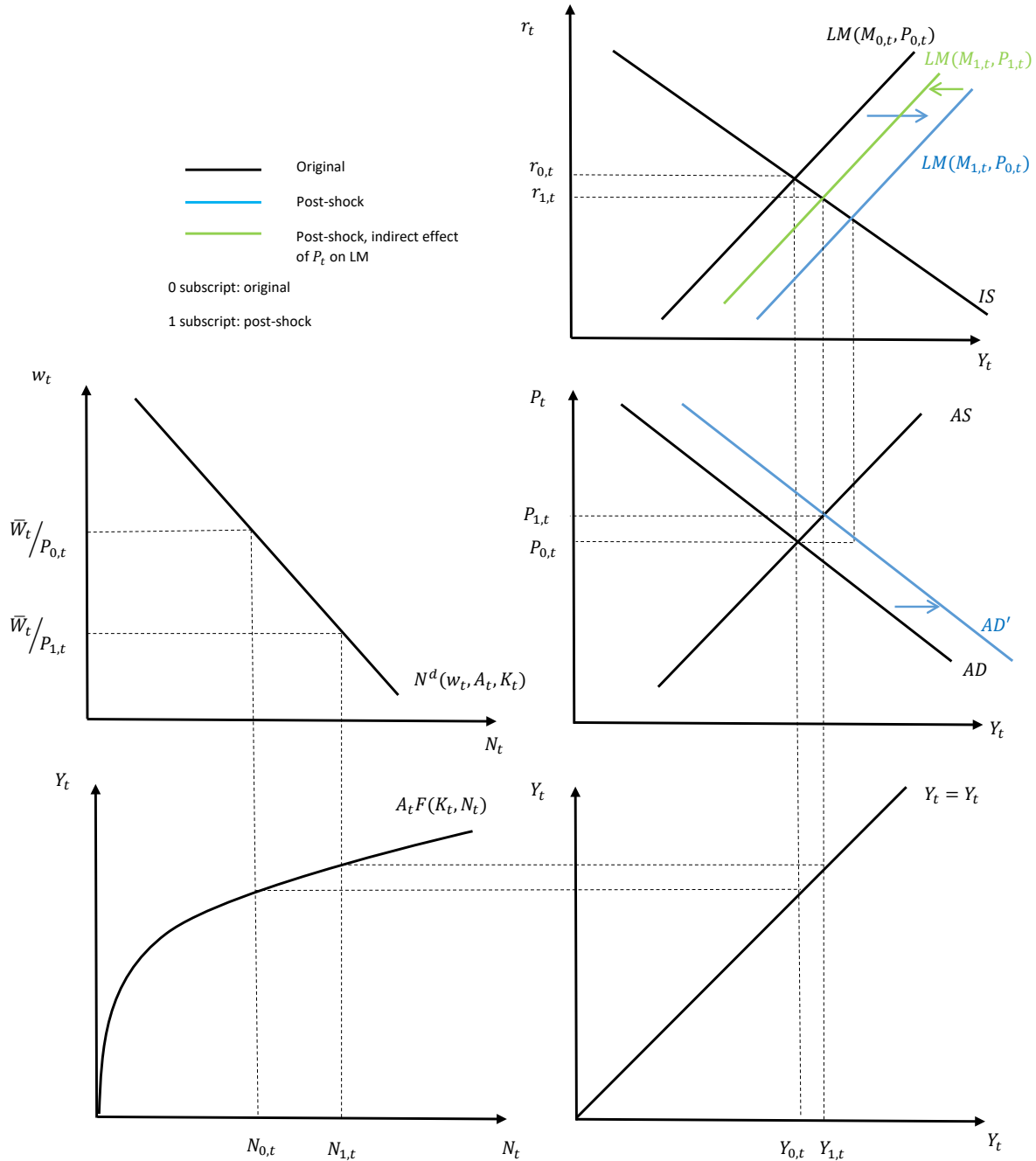

The LM curve shifting out to the right means that the level of output consistent with being on both the IS and LM curves is now higher, holding the price level fixed at $P_{0,t}$. This means that the AD curve shifts out to the right (which is shown in blue, and labeled AD' in the figure). For the economy to be in equilibrium, it must be on both the AD and AS curves. This means that the price level must rise to $P_{1,t}$ and output to $Y_{1,t}$ at the point where the new AD curve intersects the AS curve (which does not shift). The higher price level causes the LM curve to shift inwards. This is shown in green in the figure, and labeled $LM(M_{1,t}, P_{1,t})$. The inward shift of the LM curve is such that the IS and LM curves intersect at the same level of output where the AD and AS curves intersect. Having now determined how Y_t , P_t , and r_t react to a change in M_t , we can now look at the behavior of labor market variables. Since output is higher but there has been no change in productivity (or capital), labor input must be higher. We can graphically determine the new value of labor input by working “backwards” in the graph – take the new value of output, reflect it off the 45 degree line, and determine the value of N_t consistent with this level of output from the production function. The new real wage is read off the labor demand curve at this new level of labor input. Since P_t rises and the nominal wage is fixed, the real wage is lower, while labor input is higher. Since r_t is lower, I_t will be higher. Since r_t is lower and Y_t is higher, C_t will also be higher.

As in the sticky price model, and different relative to the neoclassical model, money is non-neutral in the sense that an increase in the money supply results in higher output. The mechanism responsible for this is the fact that the nominal wage is sticky. When the money supply increases, the price level rises. For a fixed nominal wage, a higher price level lowers the real wage that the firm must pay for labor. This lower real wage induces the firm to hire more labor, and hence to produce more. In order for total expenditure to increase with output, the real interest rate must fall so that consumption and investment both rise. Compared to the sticky price model, many of the effects on endogenous variables of an increase in M_t are the same (i.e. output rises and the real interest rate falls), though the mechanism giving rise to monetary non-neutrality is different. In the sticky wage model, the real wage declines, inducing firms to hire more labor. In the sticky price model, in contrast, the real wage rises when M_t increases.

Next, let’s consider a change in an exogenous variable which results in the IS curve shifting out to the right. We will generically call this an “IS Shock.” This could arise from an increase in A_{t+1} , an increase in G_t , or a reduction in G_{t+1} . In Figure D.6, the IS curve shifts out to the right. Holding the price level fixed, the level of output consistent with being on both the IS and LM curves is now higher. This means that the AD curve shifts out horizontally to the right. Since the economy must be on both the AD and AS curves in equilibrium, the price

level must rise to $P_{1,t}$, and output must increase to $Y_{1,t}$ (which is smaller than the increase in output would be if the price level were fixed). The higher price level induces an inward shift of the LM curve, shown in the diagram in green and labeled $LM(M_t, P_{1,t})$. This inward shift of the LM curve is such that the levels of output where the IS and LM curves intersect is the same as where the AD and AS curves intersect. The real interest rate is higher. Next, we can consider what happens in the labor market. The higher level of output must be supported by higher labor input, since A_t and K_t are unchanged. This higher level of labor input comes about through a reduction in the real wage, which occurs because the price level rises while the nominal wage is fixed.

Figure D.6: Effects of Positive IS Shock

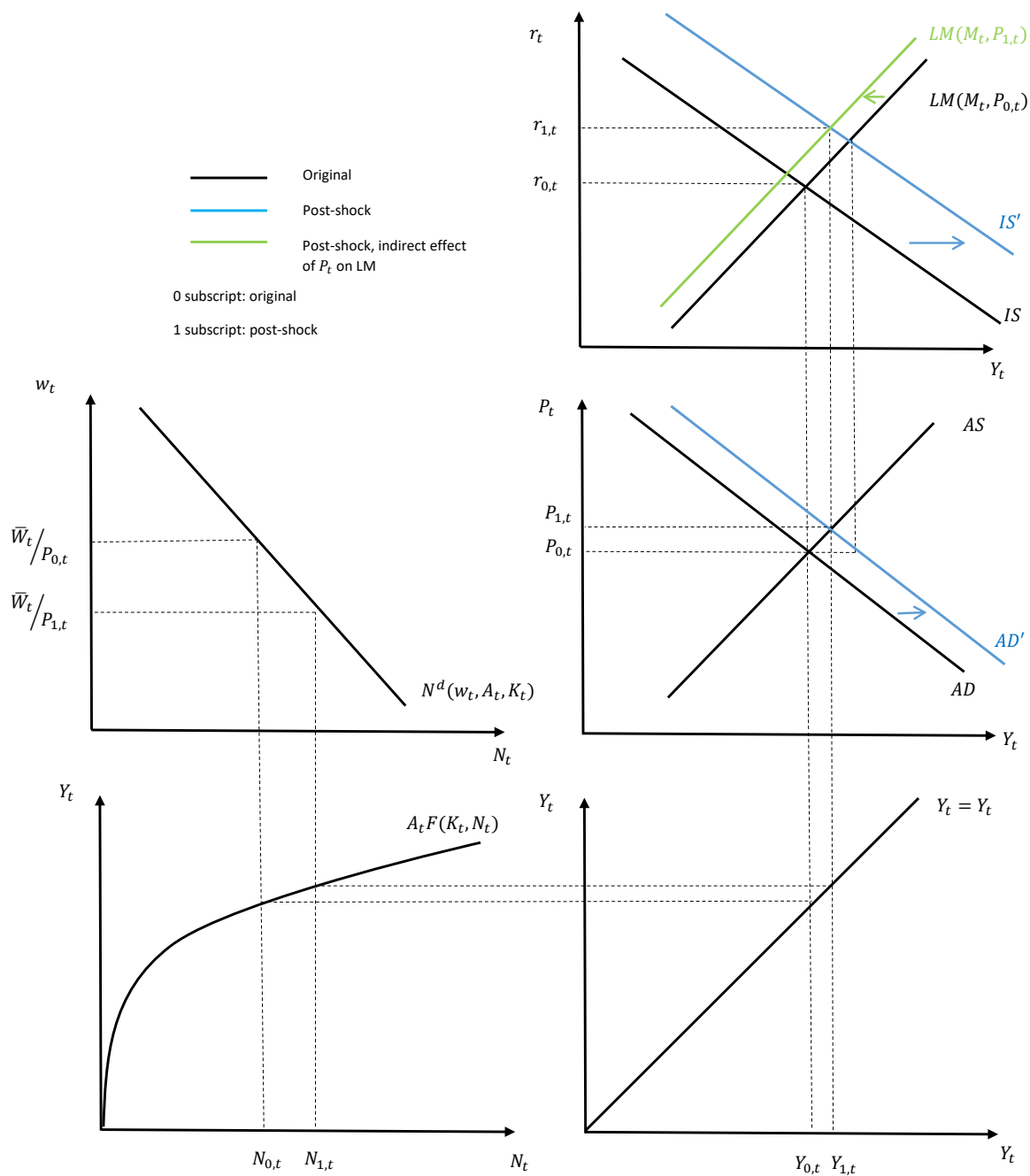

Next, let us consider an exogenous increase in A_t . These effects are shown graphically in Figure D.7 below:

Figure D.7: Effects of Increase in A_t

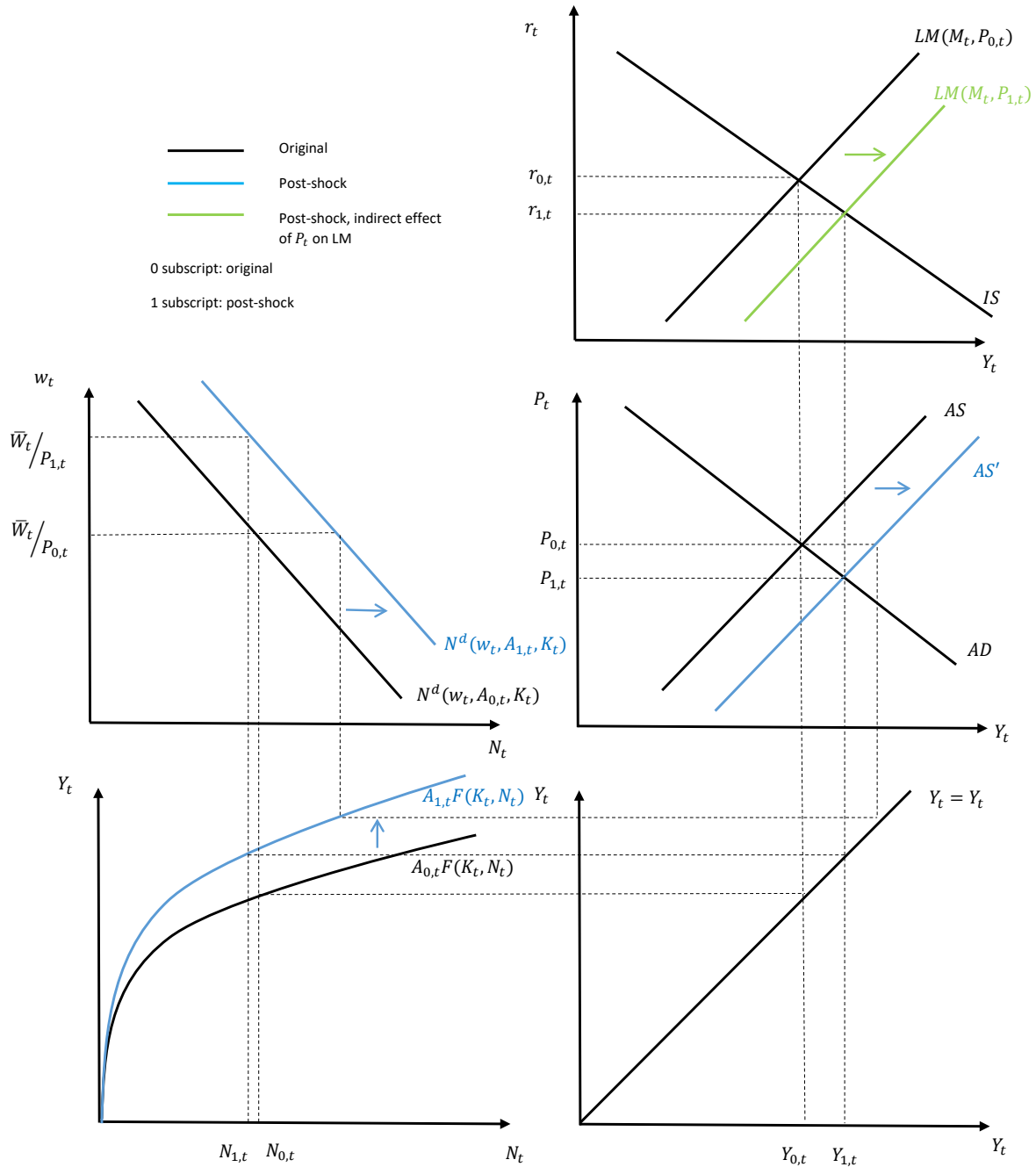

The increase in A_t causes the labor demand curve to shift out to the right, which is shown in blue. Holding the price level fixed at $P_{0,t}$, this results in more labor input. Combined with the production function shifting up, this means that output will be higher for a given price level. Put another way, the AS curve shifts out to the right. There is no shift in the AD curve. To be on both the AD and new AS curves, the price level must fall to $P_{1,t}$, with output

rising. The lower price level induces a rightward shift of the LM curve (shown in green) so that the level of output where the IS and LM curves intersect is the same as the level of output where the AD and AS curves intersect. Having now determined how output and the price level react, we can turn attention to the labor market. The higher price level results in the real wage rising. This means that the increase in labor input will be smaller than if the price level were fixed (put another way, the change in equilibrium output is smaller than the horizontal shift of the AS curve). Depending on the relative slopes of the AD and AS curves, labor input could be higher, unchanged, or lower after the increase in A_t . In the graph, we have drawn it where labor input actually declines. We will return to this issue in more detail when comparing the predictions of the sticky wage model to the neoclassical model.

Lastly, consider an exogenous change in \bar{W}_t . For a given price level, this raises the real wage, and thereby induces the firm to employ less labor. This results in a reduction in output for a given price level, leading to an inward shift of the AS curve. This is shown in Figure D.8. With the AS curve shifting in, to be on both the AS and AD curves the price level must rise to $P_{1,t}$. Output falls to $Y_{1,t}$, but by less than the horizontal shift in the AS curve. The higher price level triggers an inward shift of the LM curve (shown in green), which results in the real interest rate rising. The higher price level also lowers the real wage (relative to what it would be with the higher \bar{W}_t but the fixed price level), though the real wage remains higher than it would have been in the absence of the increase in \bar{W}_t . Consequently, labor input falls to $N_{1,t}$.

Figure D.8: Effects of Increase in \bar{W}_t

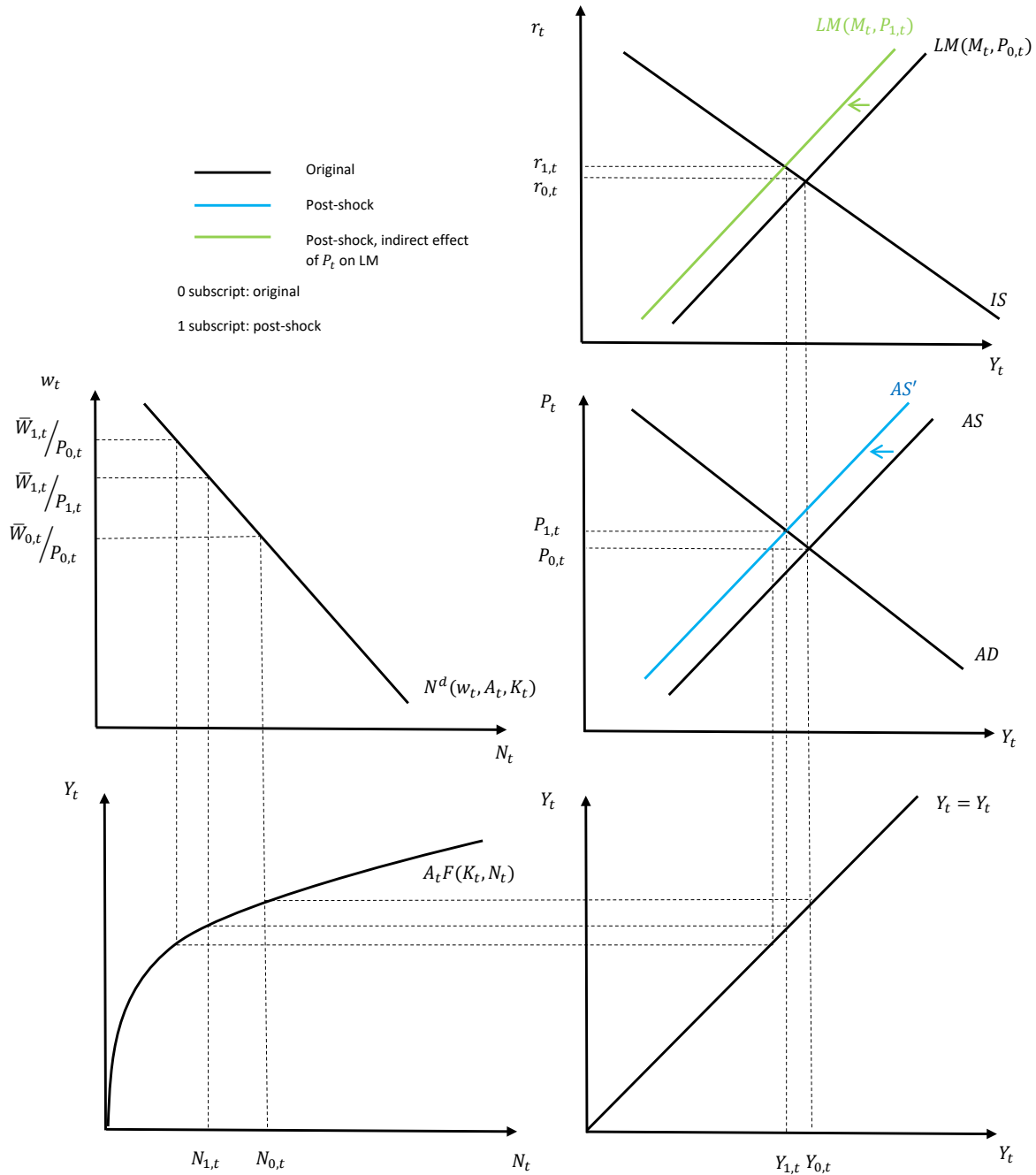

Table D.2 below summarizes the qualitative effects of changes in the relevant exogenous variables on the endogenous variables of the sticky wage model. We omit the effects on C_t and I_t , which depend upon what drives the IS curve out to the right.

Table D.2: Qualitative Effects of Exogenous Shocks on Endogenous Variables in the Sticky Wage Model

Variable	Exogenous Shock			
	$\uparrow M_t$	\uparrow IS curve	$\uparrow A_t$	$\uparrow \bar{W}_t$
Y_t	+	+	+	-
N_t	+	+	?	-
w_t	-	-	+	+
r_t	-	+	-	+
i_t	-	+	-	+
P_t	+	+	-	+

The entry for the effect of an increase in A_t on N_t is appears as a ? because the effect is ambiguous, as discussed above. We will return to this point more later.

D.1.1 Comparing the Sticky Wage Model to the Neoclassical Model

Because the sticky wage model generates a non-vertical AS curve, we can immediately conclude that demand shocks (both shocks which shift the LM curve, e.g. changes in M_t , and shocks which shift the IS curve, e.g. G_t) have bigger effects on output than they would in the neoclassical model. This result is qualitatively similar to what we find in the text when focusing on either the simple sticky price or partial sticky price models.

What about supply shocks? In the sticky wage model, we know that θ_t has no effect on the equilibrium values of endogenous variables because the labor supply curve is not relevant for the determination of the economy's equilibrium. Hence, changes in θ_t have smaller effects on output and other variables than in the neoclassical model. Things are more nuanced in response to an exogenous change in A_t . Consider Figure D.9 below. There we show how the AS curves in the sticky wage and neoclassical models shift in response to an increase in A_t without showing an AD curve. We assume that the economy initially starts with $Y_{0,t} = Y_{0,t}^f$ at $P_{0,t}$. Focusing first on the sticky wage model, the increase in A_t causes the labor demand curve to shift right and the production function to shift up. Since labor is determined solely off of the labor demand curve in the sticky wage model, we can determine the new level of output supplied for a fixed initial price by reading labor input off of the labor demand curve at a fixed real wage (since we are holding the price level fixed at $P_{0,t}$ and the nominal wage is fixed by construction). This gives a new output level of $Y_{1,t}$, and the sticky wage AS curve

shifts horizontally to the right by the amount $Y_{1,t} - Y_{0,t}$. These effects are depicted in blue in Figure D.9.

Figure D.9: Effects of Increase in A_t on Sticky Wage AS and Neoclassical AS

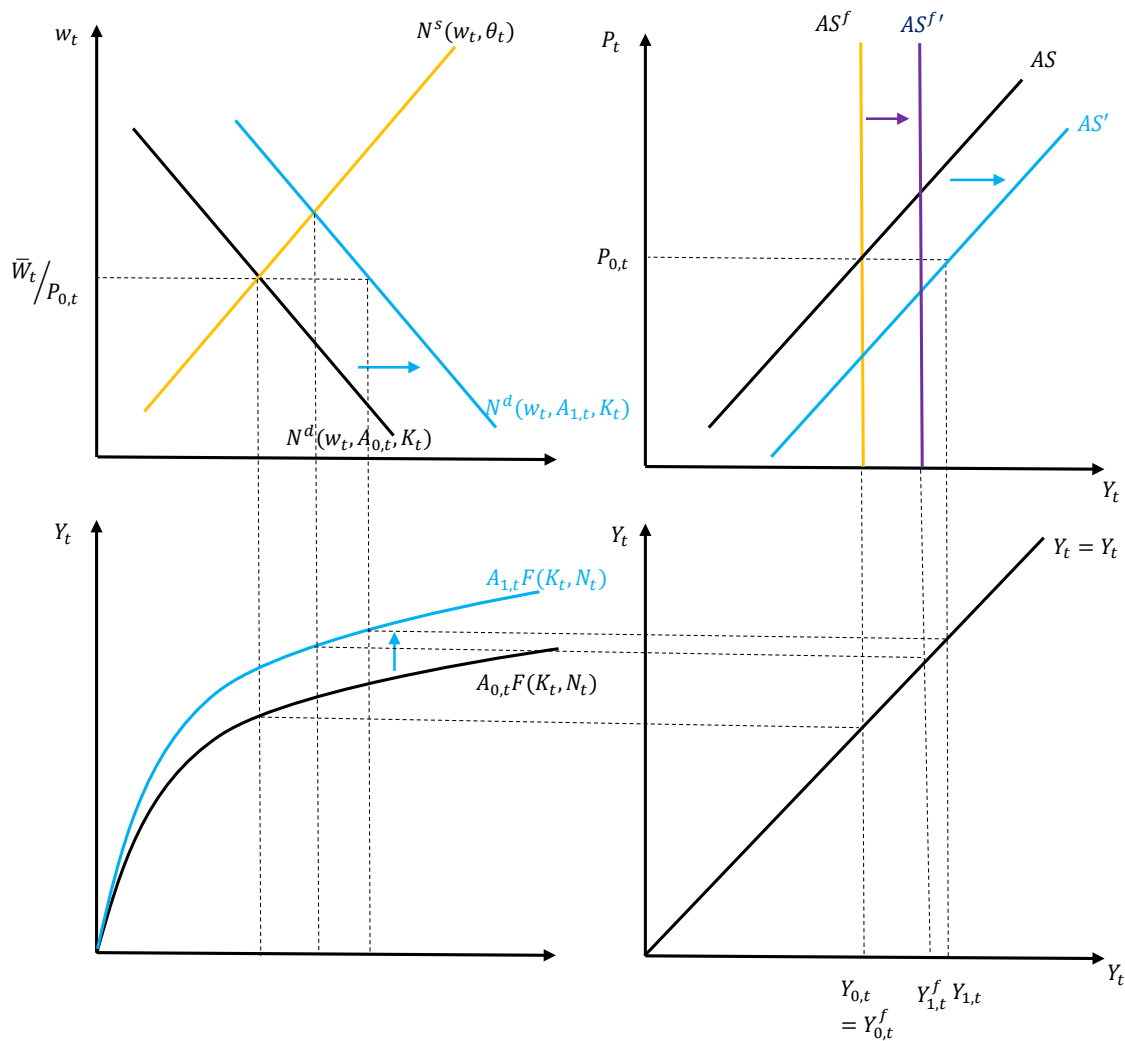

Consider next what would happen to the AS curve in the neoclassical model. In the neoclassical model, the labor supply curve is relevant for the determination of equilibrium labor input. The labor demand curve and production function would both shift by the same amount as they would in the sticky wage model, but labor input would be determined by the intersection of the new labor demand curve (blue) with the hypothetical labor supply curve (orange). Since the labor supply curve is upward-sloping, labor input would increase by less after an increase in A_t in the neoclassical model than it would in the sticky wage model with a fixed price level. This then implies that output would increase less in the neoclassical model after an increase in A_t than it would in the sticky wage model holding the price level

fixed. Put slightly differently, the AS curve in the sticky wage model shifts out *more* to the right after an increase in A_t than the vertical neoclassical AS curve shifts out.

The fact that the sticky wage AS curve shifts horizontally more after an increase in A_t than in the hypothetical neoclassical equilibrium does not necessarily imply that output and labor input will react more to an increase in A_t in equilibrium in the sticky wage model. How output reacts in comparison to the neoclassical model depends not just on the magnitude of the horizontal shift in the AS curve, but also on the slope of the AD curve.

Figure D.10: Effects of Increase in A_t on Sticky Wage AS and Neoclassical AS, Slope of AD

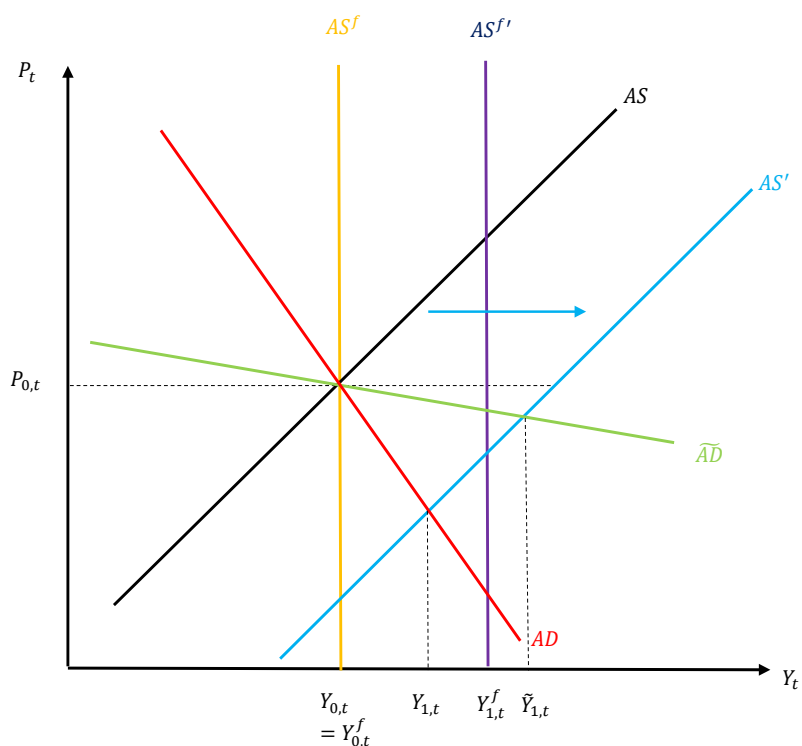

To see this point clearly, refer to Figure D.10. In this figure we focus just on the AD-AS curves to make things as clear as possible. We show two AS curves – the neoclassical AS curve, AS^f , and the sticky wage AS curve, AS . We consider two different AD curves – AD and \widetilde{AD} , where \widetilde{AD} is flatter than AD . We assume that the initial equilibrium occurs where all of these curves cross at $P_{0,t}$. Then we consider a rightward shift of the supply curves. As noted above, we show the upward-sloping, sticky wage AS curve shifting horizontally to the right by more (blue) than the vertical neoclassical AS curve (purple). In the neoclassical model, how output reacts in equilibrium is a function solely of the shift of the AS curve – the slope of the AD curve does not matter, and in either case output increases from $Y_{0,t}^f = Y_{0,t}$ to $Y_{1,t}^f$. In the sticky wage model this is not so. When the AD curve is comparatively steep (as shown in red and demarcated AD), even though the sticky wage AS curve shifts out

horizontally more than the neoclassical AS curve does, in equilibrium output nevertheless increases by less. In contrast, if the AD curve is very flat, shown in the figure in green, output may increase by more in response to an increase in A_t in the sticky wage model in comparison to the neoclassical model. Without taking a stand on the slope of the AD curve, we cannot determine in which model output will react by more.

Table D.3 qualitatively compares the responses of endogenous variables to different shocks in both the sticky wage (SW) and neoclassical (NEO) models. For the case of productivity shocks, the table shows several “?” denoting that the relative change in the endogenous variable cannot be definitively signed.

Table D.3: Comparing the Sticky Wage and Neoclassical Models

Variable	Exogenous Shock			
	$\uparrow M_t$	\uparrow IS curve	$\uparrow A_t$	$\uparrow \theta_t$
Change in Y_t	SW > NEO	SW > NEO	SW ? NEO	SW < NEO
Change in N_t	SW > NEO	SW > NEO	SW ? NEO	SW < NEO
Change in w_t	SW < NEO	SW < NEO	SW ? NEO	SW < NEO
Change in r_t	SW < NEO	SW < NEO	SW ? NEO	SW < NEO
Change in i_t	SW < NEO	SW < NEO	SW ? NEO	SW < NEO
Change in P_t	SW < NEO	SW < NEO	SW ? NEO	SW < NEO

We can therefore see that the sticky wage model has similar implications to the sticky price model. Relative to the neoclassical model, output reacts more to demand shocks and, with the caveat about productivity shocks as discussed above noted, less to supply shocks. Is there any dimension along with the sticky price and sticky wage models make different predictions conditional on shocks? Yes, and it relates to the cyclical behavior of the real wage. In the sticky price model, since the real wage is determined along the labor supply curve, the real wage is procyclical conditional on demand shocks. By procyclical we mean that the real wage moves in the same direction as output conditional on shocks to the AD curve. The reverse is true in the sticky wage model, where the real wage is determined from labor demand instead of labor supply. In that model, while demand shocks can affect output, the mechanism through which they do so is a countercyclical real wage – i.e. the real wage declines when output goes up due to a shift in the AD curve. To the extent to which one jointly believes that the real wage is strongly procyclical in the data (see the discussion in Chapter 19) and that demand shocks are major driver of short run output fluctuations, the

sticky price model can do a better job at matching the data than can the sticky wage model.

D.2 Dynamics in the Sticky Wage Model

We next study the dynamic behavior of the economy as it transitions from short run to medium run in the sticky wage model.

D.2.1 A Non-Optimal Short Run Equilibrium

Consider an initial equilibrium in which the AS and AD curves intersect at a value of output, $Y_{0,t}^{sr}$ which is higher than it would be if the nominal wage were flexible, $Y_{0,t}^f$. This is depicted in Figure D.11. The AD and AS curves intersect to the right of the hypothetical flexible wage AS curve. This means that labor input is higher than it would be if wages were flexible. Put differently, this means that the equilibrium real wage is lower than the household would like – the household is working more than it would like given the real wage. Given this situation, there will be pressure on the household to demand a higher nominal wage.

Figure D.11: Sticky Wage Model: $Y_{0,t} > Y_{0,t}^f$

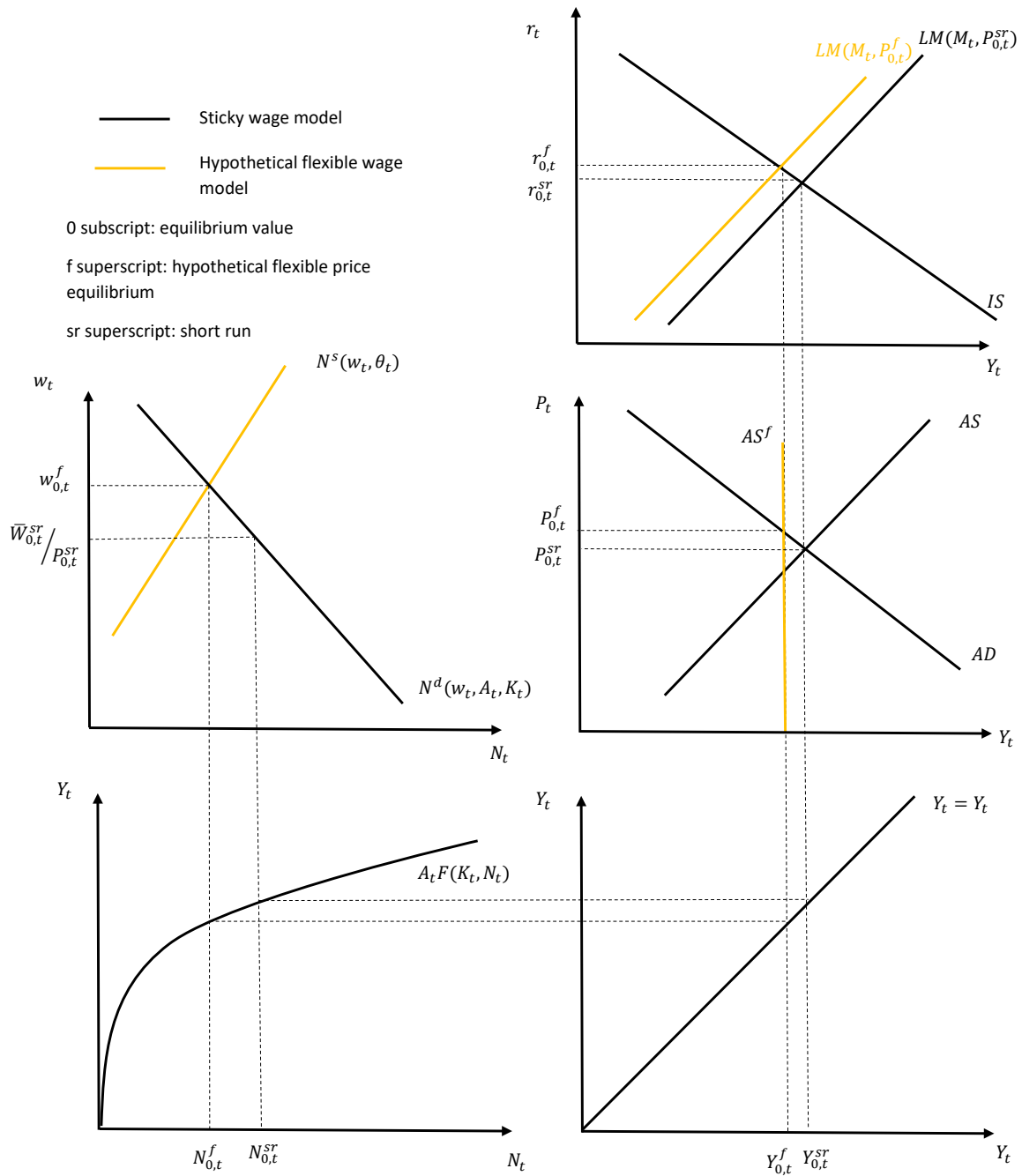

The dynamics of this situation are depicted in Figure D.12. The household will demand a sufficiently higher nominal wage $\bar{W}_{0,t}^{mr}$, such that the AS curve will shift in (shown in gray) by an amount such that it intersects the AD curve at the hypothetical neoclassical equilibrium level of output. The new short run equilibrium, denoted with *mr* superscripts, will correspond to the hypothetical flexible wage equilibrium.

Figure D.12: Sticky Wage Model: $Y_{0,t} > Y_{0,t}^f$, Dynamic Wage Adjustment

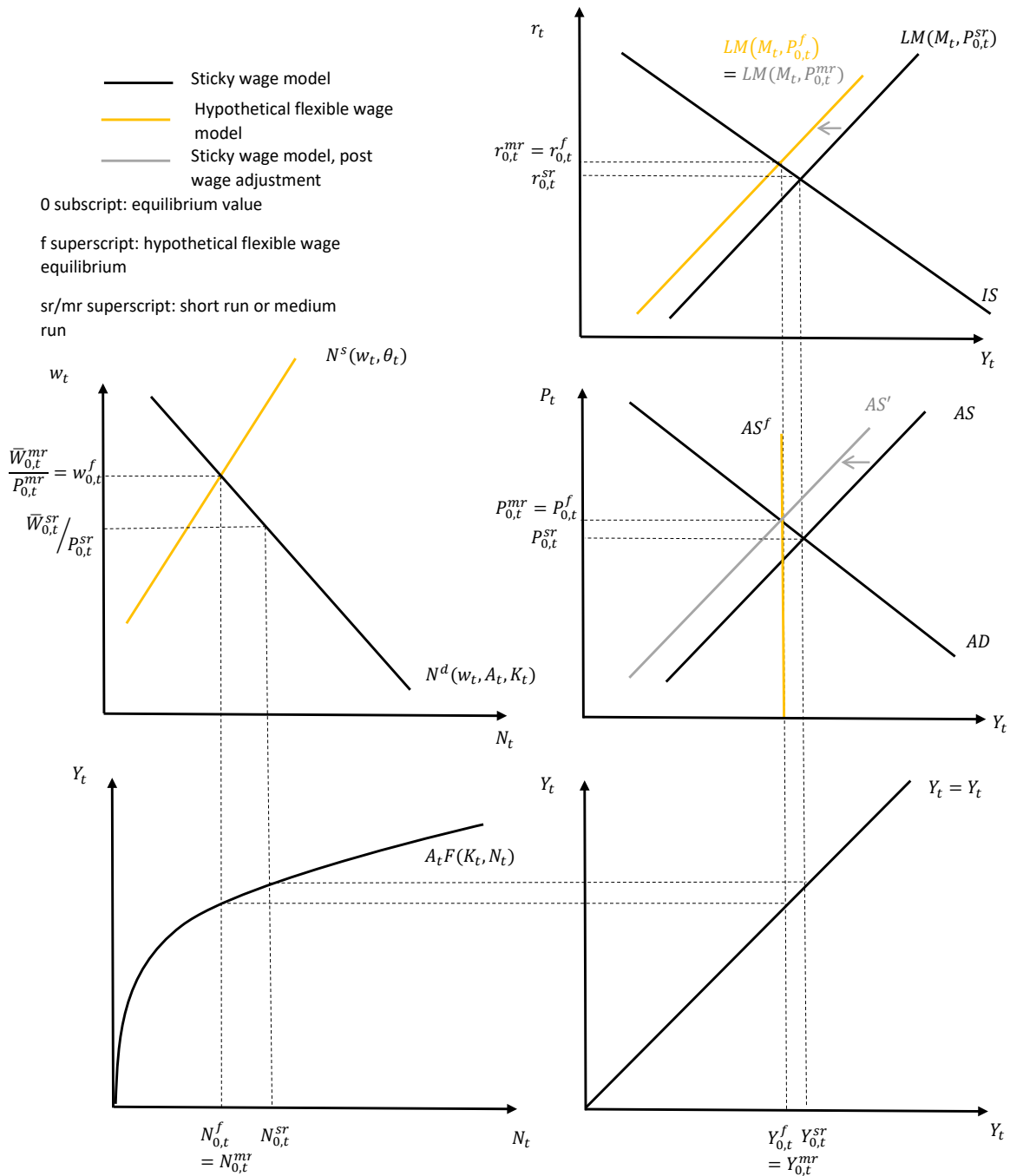

D.2.2 Dynamic Responses to Shocks

As we did for both variants of the sticky price model, in this subsection we think about the dynamic responses to shocks in the sticky wage model as the economy transitions from short run to medium run. In all exercises, we assume that the economy initially begins in an

equilibrium which coincides with the neoclassical model.

Consider first an exogenous increase in M_t . For a given price level, this triggers an outward shift of the LM curve and hence a rightward shift of the AD curve (shown in blue in Figure D.13). The AS curve is upward-sloping. As a result, output and the price level both increase to $Y_{1,t}^{sr}$ and $P_{1,t}^{sr}$, respectively. The higher price level triggers a leftward shift of the LM curve (shown in green), but not all the way back to where it started. Hence, the real interest rate falls. Higher output means that there must be more labor input. With a fixed nominal wage, a higher price level results in a lower real wage, which supports a higher level of labor input since the labor is determined off of the labor demand curve.

Figure D.13: Sticky Wage Model: Increase in M_t , Dynamics

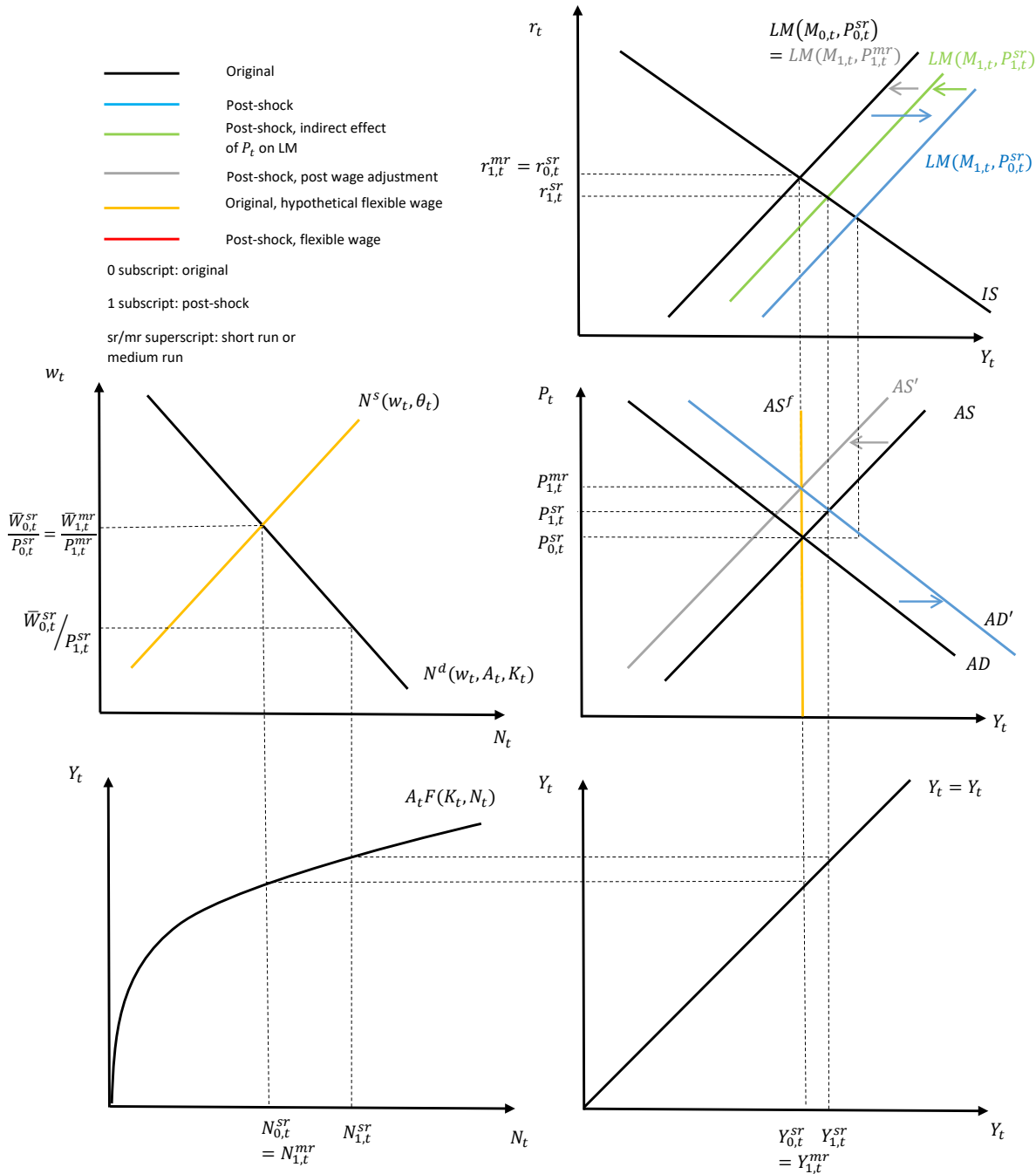

There would be no change in output in the hypothetical situation in which the nominal wage is flexible (i.e. the hypothetical AS curve is vertical). In terms of the labor market, the household is working more than it would like at the real wage given by $\frac{\bar{W}_{0,t}^{sr}}{P_{1,t}^{sr}}$. This puts upward pressure on the nominal wage. The nominal wage will increase to $\bar{W}_{1,t}^{mr}$ in such a way that the AS curve will shift inward so as to intersect the AD curve at the original level of

output (i.e. $Y_{1,t}^{mr} = Y_{0,t}^{sr}$). This results in a further increase in the price level, to $P_{1,t}^{mr}$. The increase in the price level induces the LM curve to shift in further, resulting in no ultimate change in the real interest rate. With output unchanged, ultimately labor input and the real wage are also unchanged as the economy transitions to the medium run after an increase in M_t .

Consider next a positive shock to the IS curve (due to an increase in A_{t+1} or G_t , or a decrease in G_{t+1}). These effects are shown graphically in Figure [D.14](#) below.

Figure D.14: Sticky Wage Model: Positive IS Shock, Dynamics

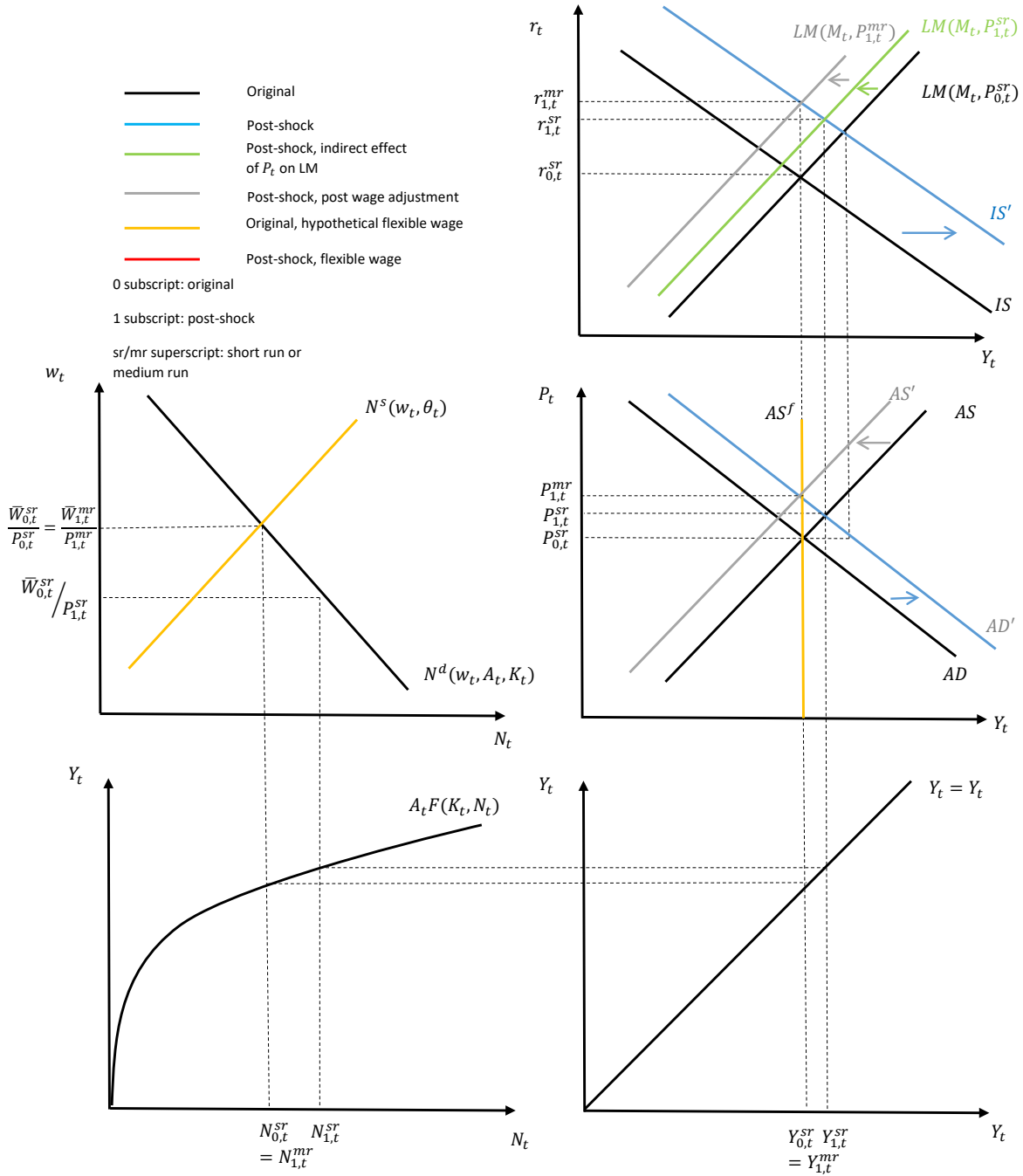

In Figure D.14, the IS curve shifts to the right (shown in blue). This results in the AD curve shifting out to the right as well. With the AS curve upward-sloping but not vertical, both output and the price level rise, to $Y_{1,t}^{sr}$ and $P_{1,t}^{sr}$, respectively. The higher price level triggers an inward shift of the LM curve (shown in green), though not all the way back to where the LM curve began before the shock. This means that the real interest rate is higher.

The higher level of output necessitates higher labor input, $N_{1,t}^{sr} > N_{0,t}^{sr}$. The higher price level drives down the real wage, given a fixed nominal wage, which supports the higher level of labor input from the labor demand curve.

The level of output would not change if the nominal wage were flexible and the AS curve vertical, and nor would the real wage or labor input. At the new equilibrium denoted with 1 subscripts, the household is working more than it would like (the quantity of labor demanded exceeds supply). This puts upward pressure on the nominal wage once the household is given a chance to renegotiate the wage. This results in a higher nominal wage, $\bar{W}_{1,t}^{mr}$, which results in an inward shift of the AS curve to AS' (shown in gray). The AS curve shifts in by an amount such that the level of output is unchanged relative to where it was before the shock (i.e. $Y_{1,t}^{mr} = Y_{0,t}^{sr}$). The price level is higher. The higher price level causes the LM curve to shift in further, resulting in a higher real interest rate. There is no ultimate change in labor input or the real wage.

Next, consider an increase in A_t . This exercise is depicted in Figure D.15. This results in an outward shift of the upward-sloping sticky wage AS curve, as well as an outward shift of the hypothetical vertical flexible wage AS curve. The outward shift of the sticky wage curve is larger than the outward shift of the vertical flexible wage AS curve. Nevertheless, we assume that the slope of the AD curve is such that output rises by less in the sticky wage model than it would if the wage were flexible. Hence, in the new sticky wage equilibrium after the increase in A_t , output is lower than it would be if prices were flexible. This means that labor input is less than it would be and the real wage is higher than it would be if the wage were flexible. This means that there is downward pressure on the nominal wage. The nominal wage will fall, to something like $\bar{W}_{1,t}^{mr}$, which results in an outward shift of the AS curve. The outward shift of the AS curve will be such that it intersects the AD curve at the point where the AD curve crosses the vertical flexible wage AS curve. This means that, as we transition to the medium run, the price level will fall, output will rise, the real interest rate will fall, labor input will rise, and the real wage will fall.

Figure D.15: Sticky Wage Model: Increase in A_t , Dynamics

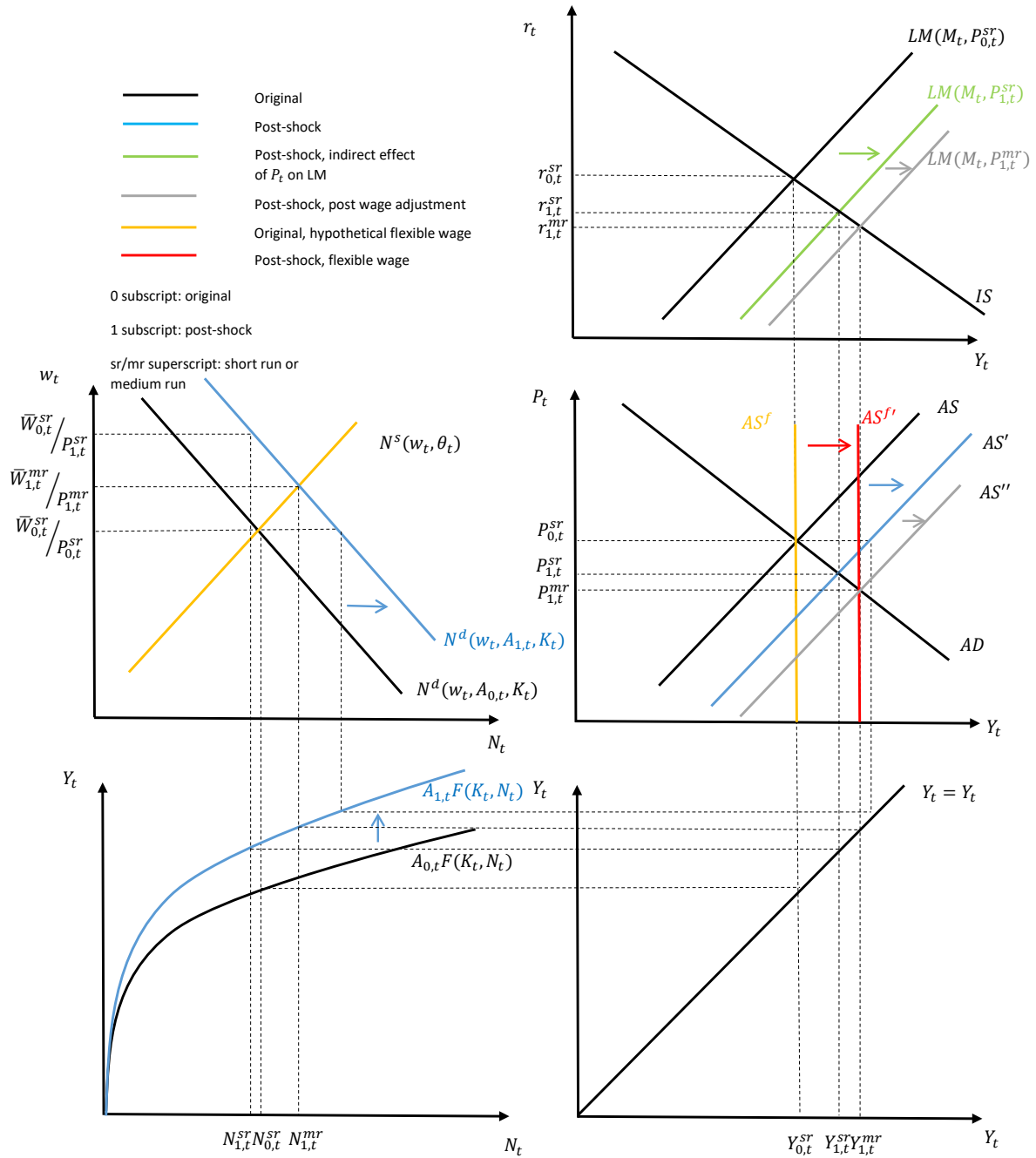

Table D.4 shows the qualitative effects of how different endogenous variables react to changes in each exogenous variable along the transition from the short run to the medium run. For the most part, this table is similar to Table 26.1. The primary exception is the behavior of the real wage. In the sticky price model, the real wage moves in the same direction as output as the economy transitions from short run to medium run; in the sticky wage model

the opposite is the case.

Table D.4: Qualitative Effects of Exogenous Shocks on Endogenous Variables in the Sticky Wage Model, Transition from Short Run to Medium Run

Variable	Exogenous Shock		
	$\uparrow M_t$	\uparrow IS curve	$\uparrow A_t$
Y_t	-	-	+
N_t	-	-	+
w_t	+	+	-
r_t	+	+	-
i_t	+	+	-
P_t	+	+	-

Appendix E

Replacing the LM Curve with the MP Curve

E.1 The AD Curve when the MP Curve Replaces the LM Curve

In Chapters 23, 25, and 27 we characterize monetary policy with the money supply, M_t . When drawing the LM curve we treat M_t as exogenous, though we can think about how M_t ought to react to shocks so as to implement the efficient equilibrium in Chapter ??.

Let us now suppose that, instead of choosing M_t , a central bank conducts policy according to a rule similar to (27.11). It turns out that we can derive a graphical representation of the short run equilibrium of the sticky price (simple or partial) New Keynesian model that is similar to what we work with in the text. There are two main differences relative to what we pursue in the text. First, we replace the LM curve specification of money demand with a policy rule written in terms of a target interest rate. We will completely omit the money supply and the money demand function from the analysis. In the background money is still a variable, but it becomes endogenous. In effect, a central bank implements an interest rate target by setting the money supply so as to equal money demand at the desired interest rate, but we need not worry about what that money supply is. Secondly, we will write the AD and AS curves as functions of π_t (the growth rate of the price level), rather than P_t , the price level itself. Otherwise, the models will look quite similar and will have very similar implications.

To begin, let us start by defining a slightly simpler version of an MP rule than what is given in (27.11). In particular, assume that the monetary policy reaction function is given by:

$$i_t = r^* + \pi^* + \phi_\pi(\pi_t - \pi^*) + e_t \quad (\text{E.1})$$

(E.1) looks the same as (27.11), except that (i) we have imposed $\phi_y = 0$, so that there is no reaction to the output gap; and (ii) we have added an exogenous term to the rule, e_t . Fluctuations in e_t will play a similar role to exogenous changes in M_t in the model of the text. Imposing that $\phi_y = 0$ simplifies the analysis without fundamentally affecting any conclusions. All other variables and parameters have the same interpretation as the presentation of the Taylor rule. We assume that $\phi_\pi > 1$, a point to which we shall return in more depth below.

Recall that the Fisher relationship relates the real interest rate to the nominal rate and

expected inflation, which in our baseline model we take to be an exogenous variable. In particular, $r_t = i_t - \pi_{t+1}^e$. So that we are not dealing with variables referencing different dates, let us here make an assumption of *adaptive expectations*. In particular, assume that expected inflation between periods t and $t + 1$ is equal to realized inflation from $t - 1$ to t . That is, assume $\pi_{t+1}^e = \pi_t$. This is not necessarily an ideal assumption but is also not wholly implausible. To write the monetary policy reaction function in terms of the real rate, rather than the nominal rate, make use of the adaptive expectations assumption and subtract π_t from both sides of (E.1). Re-arranging terms, we get:

$$r_t = r^* + (1 - \phi_\pi)\pi^* + (\phi_\pi - 1)\pi_t + e_t \quad (\text{E.2})$$

Define a new term $\bar{r}_t = r^* + (1 - \phi_\pi)\pi^* + e_t$ as the exogenous component of the policy rule. Changes in e_t will cause this term to move up or down. We can then write the rule as:

$$r_t = \bar{r}_t + (\phi_\pi - 1)\pi_t \quad (\text{E.3})$$

We shall henceforth refer to (E.3) as the “monetary policy rule” and will graphically represent it with the *MP* curve, where the *MP* stands for monetary policy. This can be seen in Figure E.1 below:

Figure E.1: The MP Curve

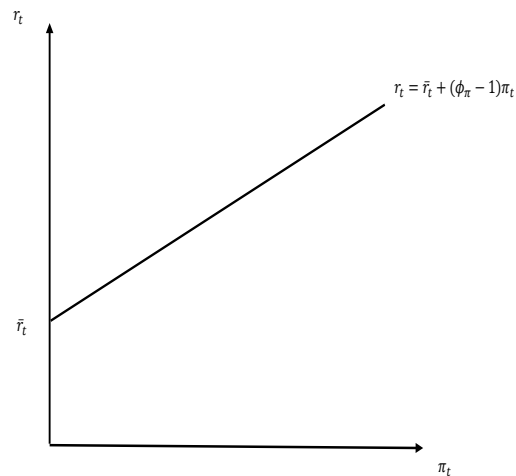

The MP curve intersects the vertical axis at \bar{r}_t . Since we assume, unless otherwise noted, that $\phi_\pi > 1$, the MP curve is upward-sloping. The MP curve tells us what the central bank’s target real interest rate is for each possible inflation rate.

The demand side of the economy is governed by the following equations:

$$C_t = C^d(Y_t - G_t, Y_{t+1} - G_{t+1}, r_t) \quad (\text{E.4})$$

$$I_t = I^d(r_t, A_{t+1}, K_t) \quad (\text{E.5})$$

$$Y_t = C_t + I_t + G_t \quad (\text{E.6})$$

$$r_t = \bar{r}_t + (\phi_\pi - 1)\pi_t \quad (\text{E.7})$$

Expressions (E.4)-(E.6) can be graphically summarized by the familiar IS curve, which shows combinations of r_t and Y_t where these equations jointly hold, taking the values of exogenous variables as given. (E.7) is the MP curve, which shows combinations of r_t and π_t where the central bank follows its policy rule. These equations can be combined to describe the set of π_t and Y_t pairs where all four equations hold. This will be the AD curve. Intuitively, if the Fed responds to higher inflation by raising the real interest rate, then from the IS curve output will fall as inflation increases. The AD curve, expressed with π_t on the vertical axis instead of P_t , will be downward-sloping.

This new version of the AD curve can be derived graphically as shown in Figure E.2. This is a four part graph. In the lower left hand portion, put π_t on the vertical axis and Y_t on the horizontal axis. This will be where the AD curve is plotted. The lower right hand portion is simply a plot of π_t against π_t ; i.e. it is a 45 degree line. This is simply a way to reflect π_t from the vertical axis to the horizontal axis. In the upper right hand portion we plot the MP curve, with r_t as a function of π_t . In the upper left hand portion, we plot the IS curve with r_t on the vertical axis and Y_t on the horizontal axis.

Figure E.2: The AD Curve with the MP Curve: Derivation

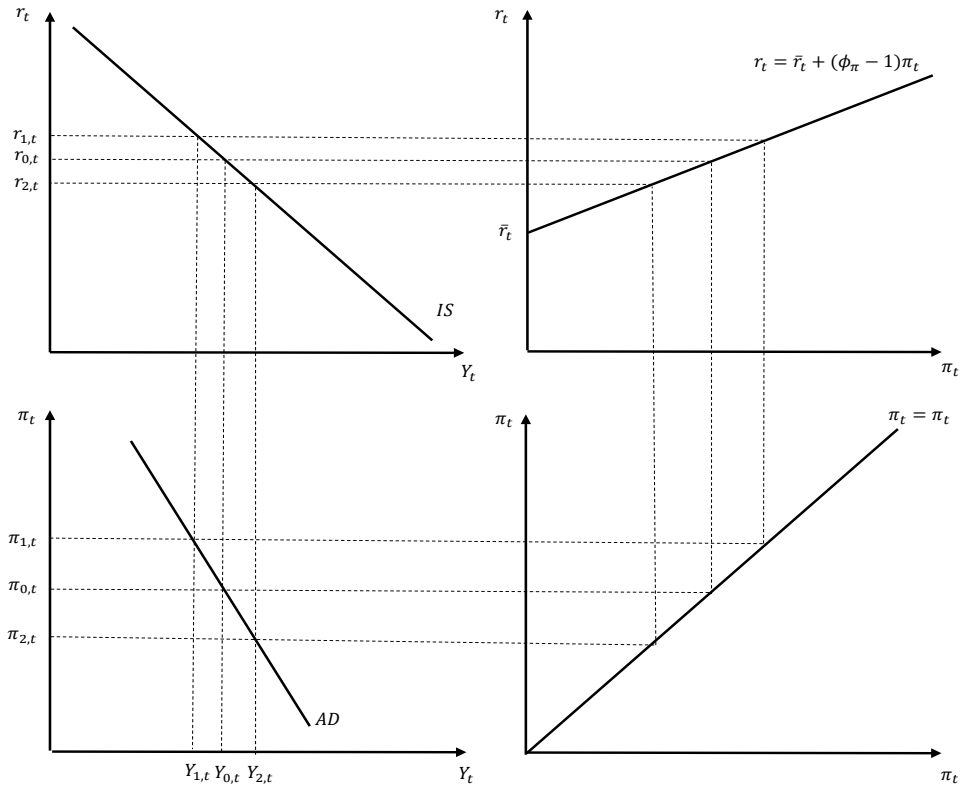

To derive the AD curve graphically, start with some inflation rate in the lower left hand plot, say $\pi_{0,t}$. Use the 45 degree line in the lower right hand portion to reflect this inflation rate onto the horizontal axis. Then determine the real interest rate, given this inflation rate, from the MP curve in the upper right hand plot. Call this real interest rate $r_{0,t}$. Then determine the level of output consistent with this real interest rate from the IS curve in the upper left hand plot. Call this $Y_{0,t}$. We then have a combination $(\pi_{0,t}, Y_{0,t})$. Then consider higher or lower values of π_t and repeat the exercise. We can graphically trace out a curve that is downward-sloping, and which we will continue to call the AD curve even though it is a slightly different construct than the AD curve on which we focus in the text.

Figure E.3: Shift of the AD Curve: Positive *IS* Shock

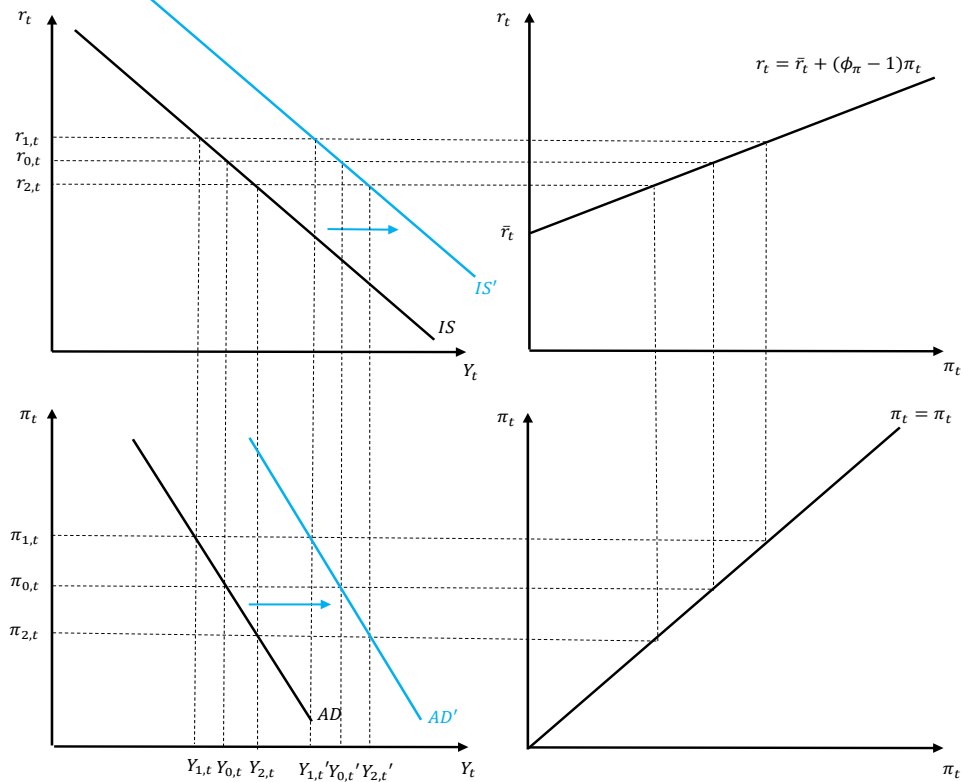

The AD curve will shift if any of the exogenous variables in (E.4)-(E.7) were to change. Consider first a change in some exogenous variable which causes the IS curve to shift (e.g. an increase in G_t or A_{t+1} , or a decrease in G_{t+1}). Holding the inflation rate fixed means we can think of holding the real interest rate fixed. This means that the level of output consistent with each possible inflation rate will increase. Hence, the AD curve will shift out horizontally to the right by an amount equal to the horizontal shift of the IS curve. This is qualitatively similar to how shifts of the IS curve affect the AD curve when it is defined based off the LM curve instead of the MP curve.

Consider next a change in the exogenous component of the MP rule, \bar{r}_t . Consider a decrease in this variable. A decrease in this variable shifts the MP curve down. Hence, for each possible inflation rate, the real interest rate will be lower. From the IS curve, this corresponds to higher output for each possible inflation rate. In other words, a reduction in \bar{r}_t causes the AD curve to shift to the right. Again, this is conceptually similar to how the AD curve shifts when it is derived from the LM curve and an increase in M_t is considered.

Figure E.4: Shift of the AD Curve: Reduction in \bar{r}_t

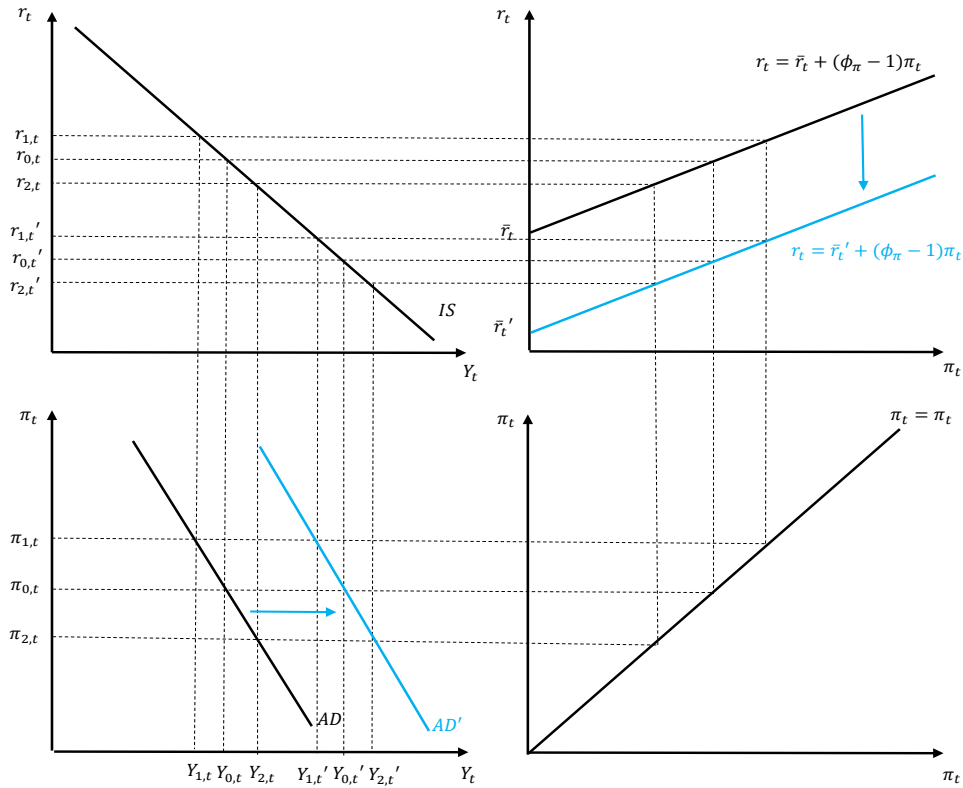

Finally, we pause to ask what impact the parameter ϕ_π has on the AD curve. We maintain the assumption that $\phi_\pi > 1$. Figure E.5 considers two different MP curves, one in which ϕ_π is quite large (shown in green), and the other in which it is smaller (but nevertheless still above one). In drawing the graph, we adjust \bar{r}_t for each specification so that the MP curves cross at an inflation rate of $\pi_{0,t}$. Then we proceed with the graphical derivation of the AD curve as we did above. When ϕ_π is bigger, a given change in inflation results in a bigger change in the real interest rate, and hence a bigger movement in output. Output is thus more sensitive to the inflation rate, and as a consequence the AD curve is flatter when ϕ_π is bigger.

Figure E.5: The AD Curve with the MP Curve: Role of ϕ_π

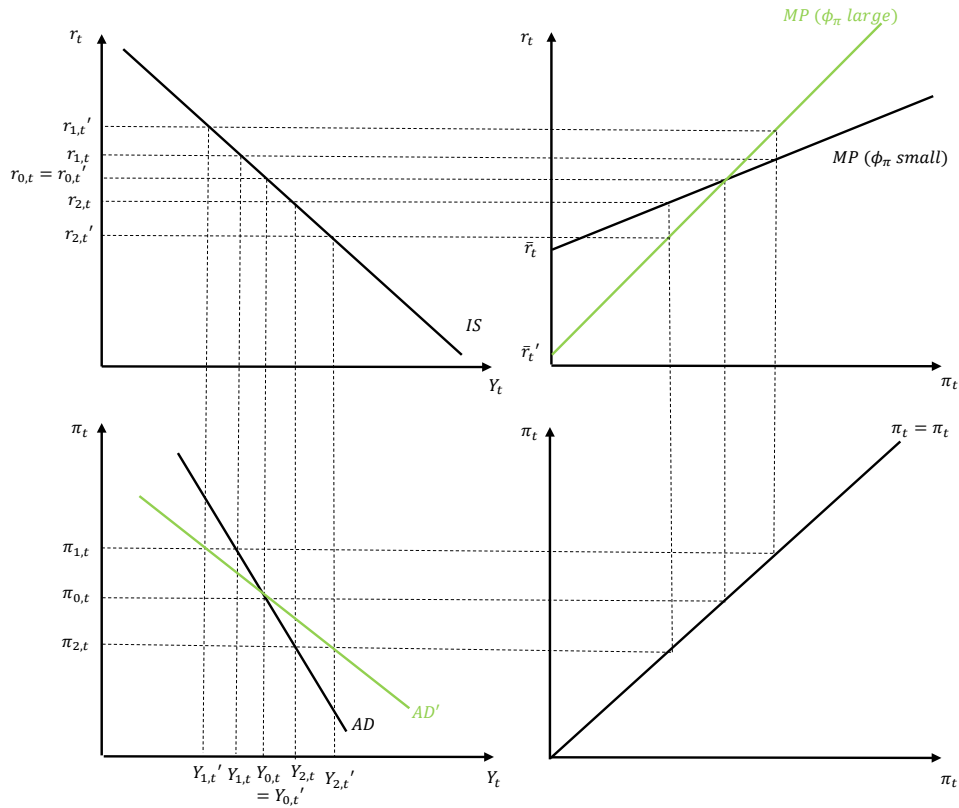

E.2 The Modified Supply Side

We have shown how we can derive a curve showing a negative relationship between Y_t and π_t . We still call this curve the AD curve, even though it is a slightly different construct than the AD curve presented in the text because it depends on the inflation rate, not the price level. The AD curve in this model is derived by combining the IS curve with the MP curve, which shows how the central bank adjusts the nominal (and hence the real, under the assumption of adaptive expectations) interest rate in response to changes in inflation. This AD curve explicitly incorporates endogenous monetary policy, whereas the AD curve derived in the text with the IS and LM curves treats monetary policy as exogenous. In this IS-MP-AD setup, we do not need to keep track of the money supply at all.

What about the supply side of the model? Recall from Chapter 24 that the partial sticky price AS curve is given as follows:

$$P_t = \bar{P}_t + \gamma(Y_t - Y_t^f) \quad (\text{E.8})$$

\bar{P}_t is the predetermined component of the price level, Y_t^f is the hypothetical neoclassical

equilibrium level of output, and $\gamma \geq 0$ is a parameter governing the degree of price stickiness. This specifications nests two special cases. When $\gamma = 0$ we have the simple sticky price model, whereas when $\gamma \rightarrow \infty$ we have the neoclassical model. As we did in Chapter 24 when introducing the notion of the Phillips Curve, subtract the lagged price level, P_{t-1} , from both sides of (E.8):

$$P_t - P_{t-1} = \bar{P}_t - P_{t-1} + \gamma(Y_t - Y_t^f) \quad (\text{E.9})$$

If we normalize $P_{t-1} = 1$, we can treat the change in the price level as the same thing as the percentage change in the price level. This means we can write $P_t - P_{t-1} = \pi_t$. Define $\pi_t^e = \bar{P}_t - P_{t-1}$, and think of this as the expected rate of inflation between $t - 1$ and t . We will treat this as exogenous. Then we can write the AS curve as:

$$\pi_t = \pi_t^e + \gamma(Y_t - Y_t^f) \quad (\text{E.10})$$

(E.10) is simply the expectations augmented Phillips Curve introduced in Chapter 24. It is our representation of the supply side of the model, and is essentially identical to what is presented in the text, except that it is written in terms of inflation rates rather than price levels. Formally, the equations characterizing the supply side of the model are given below:

$$N_t = N^s(w_t, \theta_t) \quad (\text{E.11})$$

$$Y_t = A_t F(K_t, N_t) \quad (\text{E.12})$$

(E.11)-(E.12), along with (E.10), describe the supply-side of the model. Y_t^f is determined as the solution to the following equations:

$$N_t^f = N^s(w_t^f, \theta_t) \quad (\text{E.13})$$

$$N_t^f = N^d(w_t^f, A_t, K_t) \quad (\text{E.14})$$

$$Y_t^f = A_t F(K_t, N_t^f) \quad (\text{E.15})$$

Graphically, the supply side of the model can be characterized as we have done before with a four part graph. In the upper left quadrant we plot the labor market. Only the labor supply curve is directly relevant for the determination of output, but we draw in a hypothetical labor demand curve (in orange) because the intersection of hypothetical labor demand with labor supply determines Y_t^f . The production function is plotted in the lower left corner. In the southeast corner, we plot a 45 degree line to reflect Y_t onto the horizontal axis. In the upper right quadrant we plot the AS curve. The AS curve crosses through the

point (π_t^e, Y_t^f) . Y_t^f is determined by combining the level of labor input where labor demand and supply would cross with the production function, and is denoted with a vertical orange line labeled AS^f . Other than the fact that π_t replaces P_t on the vertical axis, this is exactly the same graphically apparatus as in Chapter 24.

Figure E.6: Supply Side of the Model

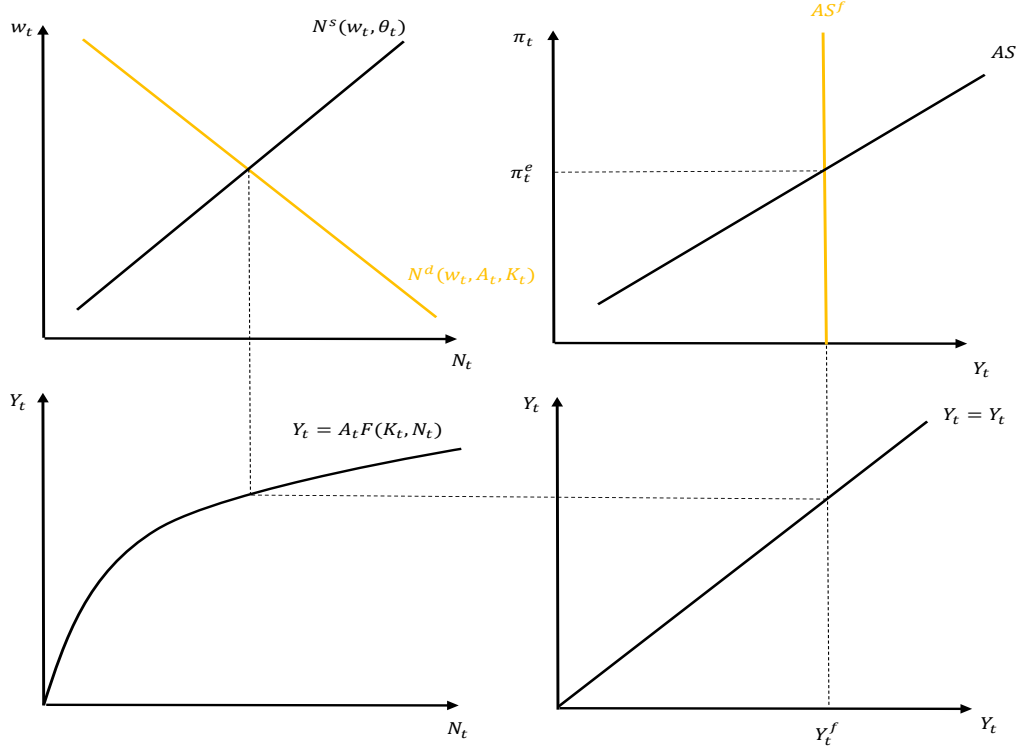

E.3 The IS-MP-AD-AS Model

The full equilibrium of the IS-MP-AD-AS model is summarized by the following equations:

$$C_t = C^d(Y_t - G_t, Y_{t+1} - G_{t+1}, r_t) \quad (\text{E.16})$$

$$N_t = N^s(w_t, \theta_t) \quad (\text{E.17})$$

$$\pi_t = \pi_t^e + \gamma(Y_t - Y_t^f) \quad (\text{E.18})$$

$$I_t = I^d(r_t, A_{t+1}K_t) \quad (\text{E.19})$$

$$Y_t = A_t F(K_t, N_t) \quad (\text{E.20})$$

$$Y_t = C_t + I_t + G_t \quad (\text{E.21})$$

$$r_t = \bar{r}_t + (\phi_\pi - 1)\pi_t \quad (\text{E.22})$$

$$r_t = i_t - \pi_t \tag{E.23}$$

These are the same as in Chapter 25 with three exceptions. First, we replace money demand with the MP rule, (E.22). Second, we write the AS curve in terms of π_t instead of P_t . Third, instead of treating expected inflation between t and $t + 1$, π_{t+1}^e , as exogenous, we replace this with an assumption of adaptive expectations, which is reflected in the Fisher relationship, (E.23). The endogenous variables are Y_t , C_t , I_t , N_t , w_t , π_t , r_t , and i_t . The exogenous variables are G_t , G_{t+1} , A_{t+1} , K_t , π_t^e , and \bar{r}_t . We do not worry about M_t , though given the determination of Y_t and r_t , we could solve for M_t by including a money demand equation.

We can graphically summarize the equilibrium with the seven part graph shown below, which simply combines the supply and demand graphs presented above:

Figure E.7: The IS-MP-AD-AS Equilibrium

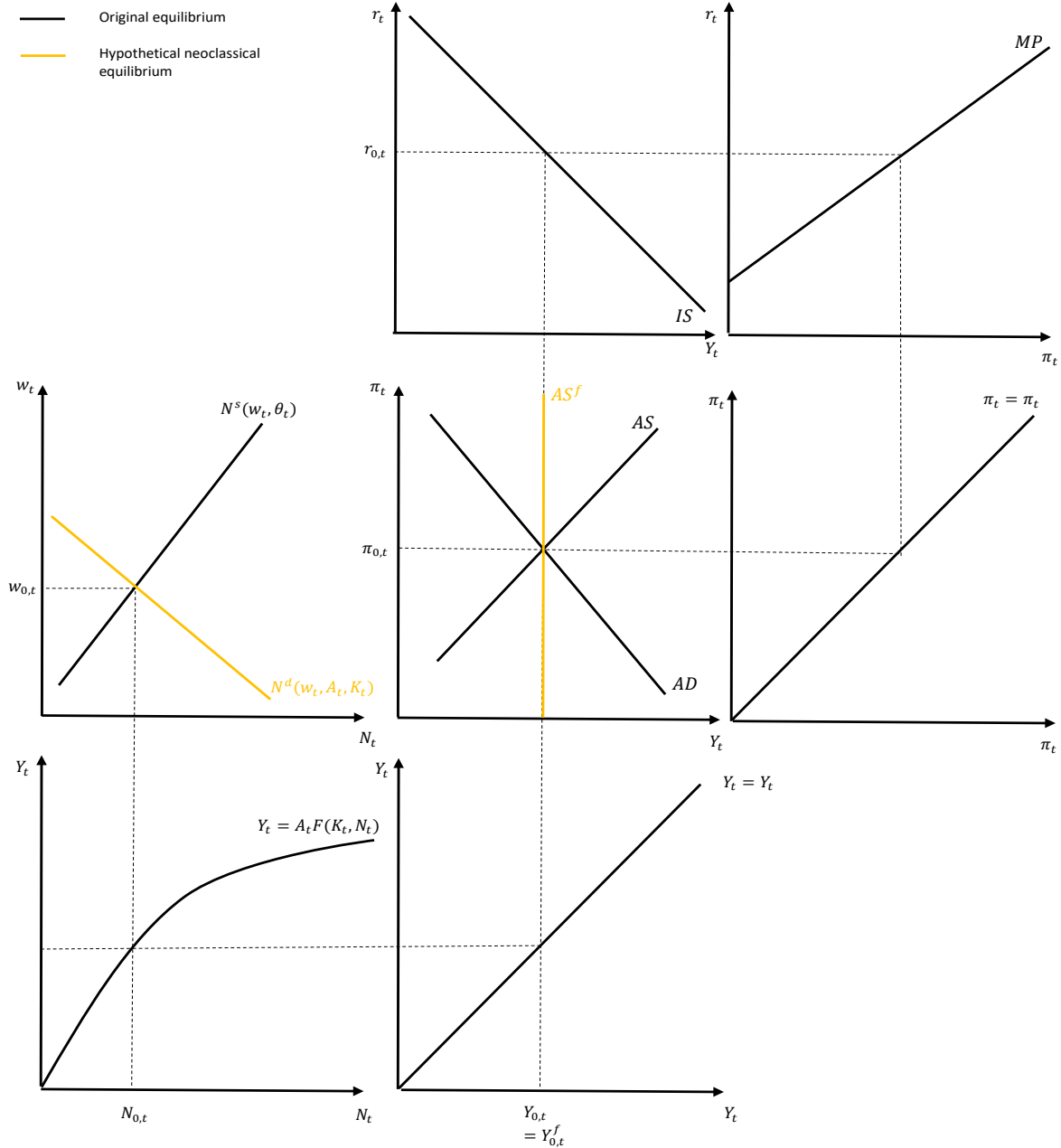

E.3.1 The Effects of Shocks in the IS-MP-AD-AS Model

As before, we can consider the effects of changes in exogenous variables on the equilibrium of the model. Consider first a shock which causes the IS curve to shift out to the right. This is shown below in Figure E.8:

Figure E.8: Positive IS Shock

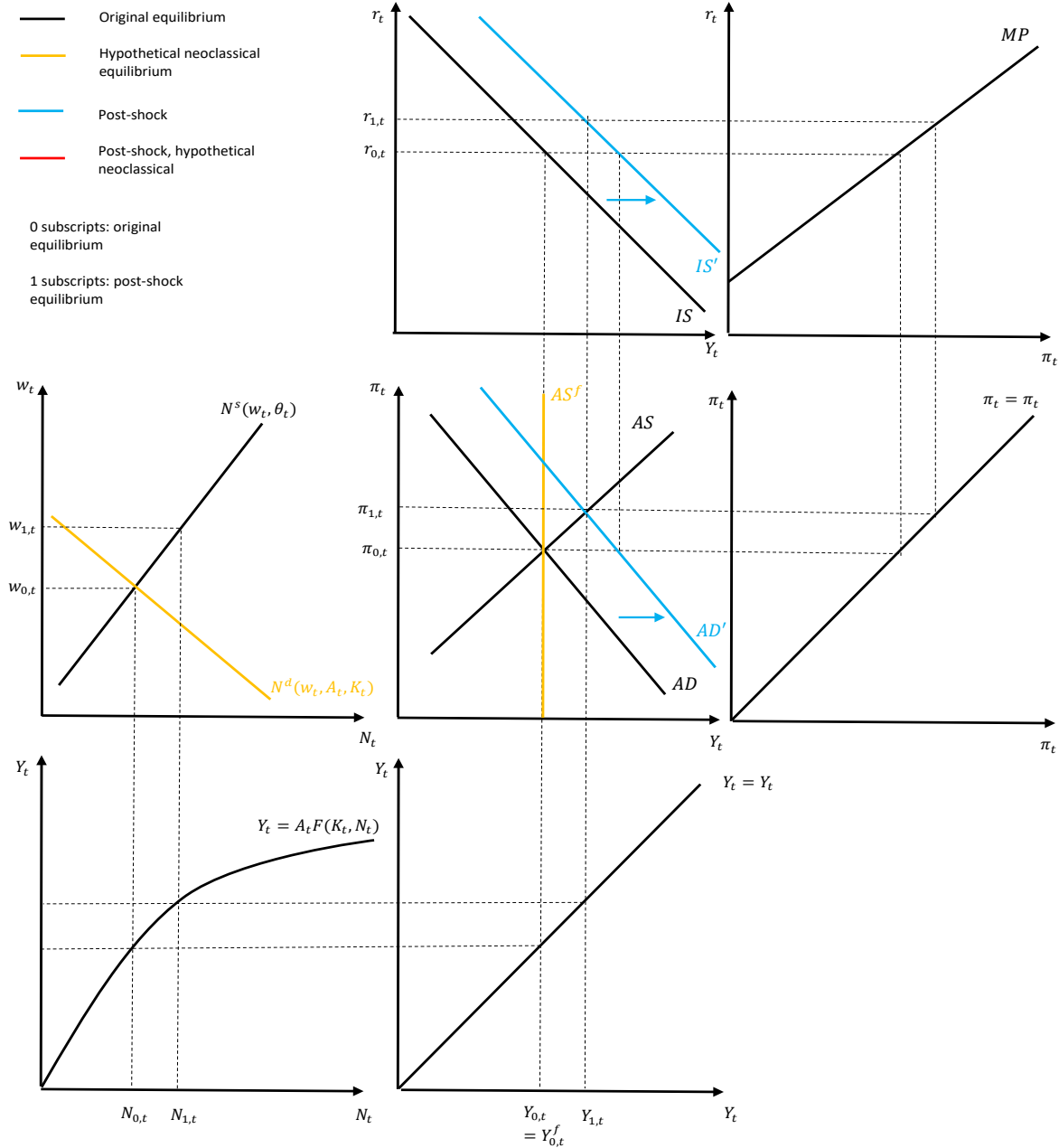

The rightward shift of the IS curve causes the AD curve to shift to the right. In equilibrium, output and inflation both rise. The higher inflation results in the central bank raising the real interest from the MP curve, which results in a movement up along the new IS curve so that output increases in equilibrium by less than the rightward shift of the IS curve. This is conceptually similar to how a change in P_t causes the LM curve to shift after an IS shock. To support higher output, labor input must increase. To convince workers to work more, the real wage must rise.

Consider next an exogenous shock to monetary policy, represented as an increase in \bar{r}_t . This is shown in Figure E.9:

Figure E.9: Increase in \bar{r}_t

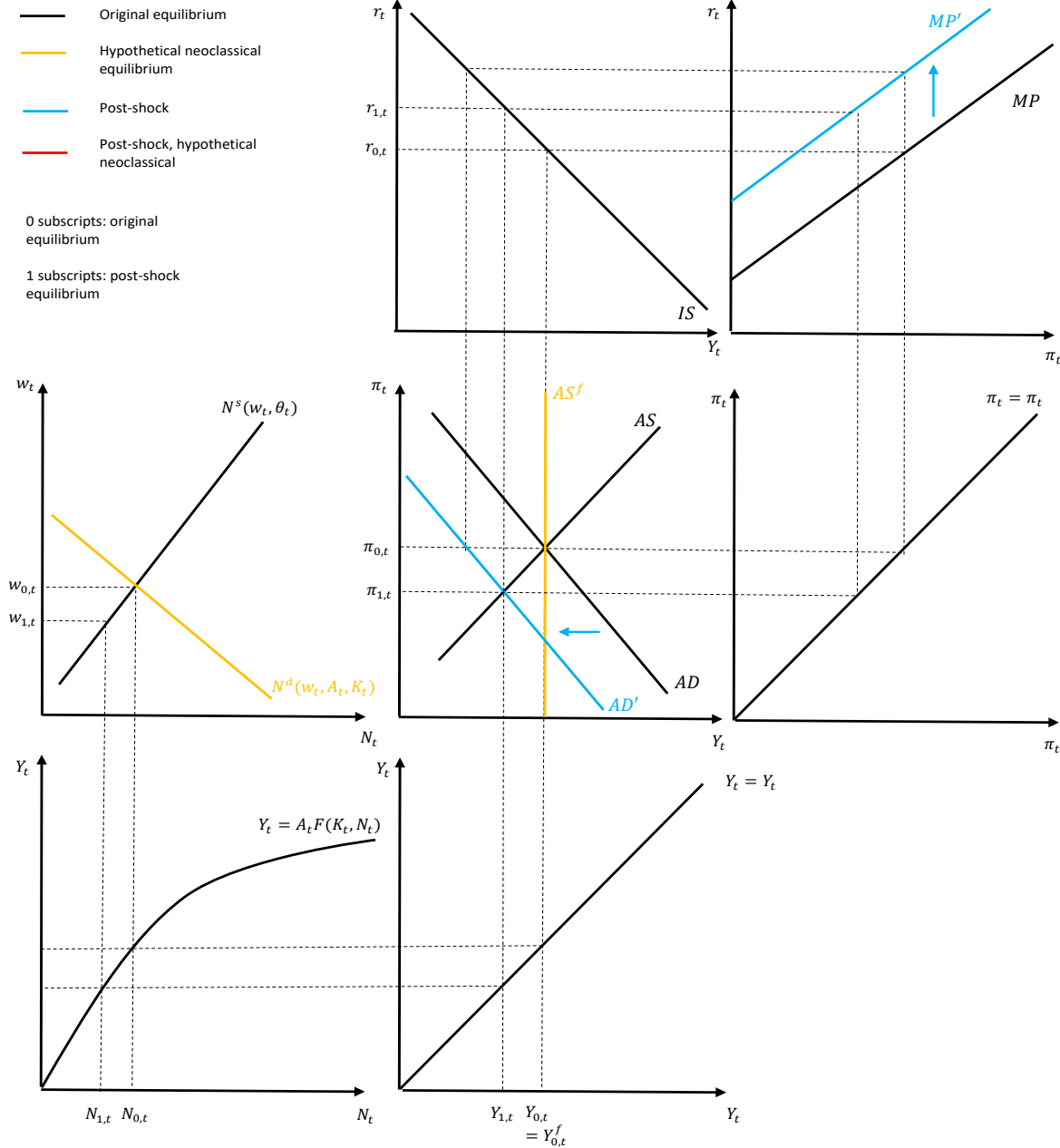

The increase in \bar{r}_t causes the MP curve to shift up, which results in the AD curve shifting in. The inward shift of the AD curve results in output and inflation both falling. The fall in inflation partially offsets the exogenous increase in \bar{r}_t , so that the real interest rate rises by less, and output falls by less, than it would if the inflation rate were held fixed. Lower output

necessitates lower labor input, which requires a lower real wage.

Next consider an increase in A_t , the effects of which are depicted in Figure E.10:

Figure E.10: Increase in A_t

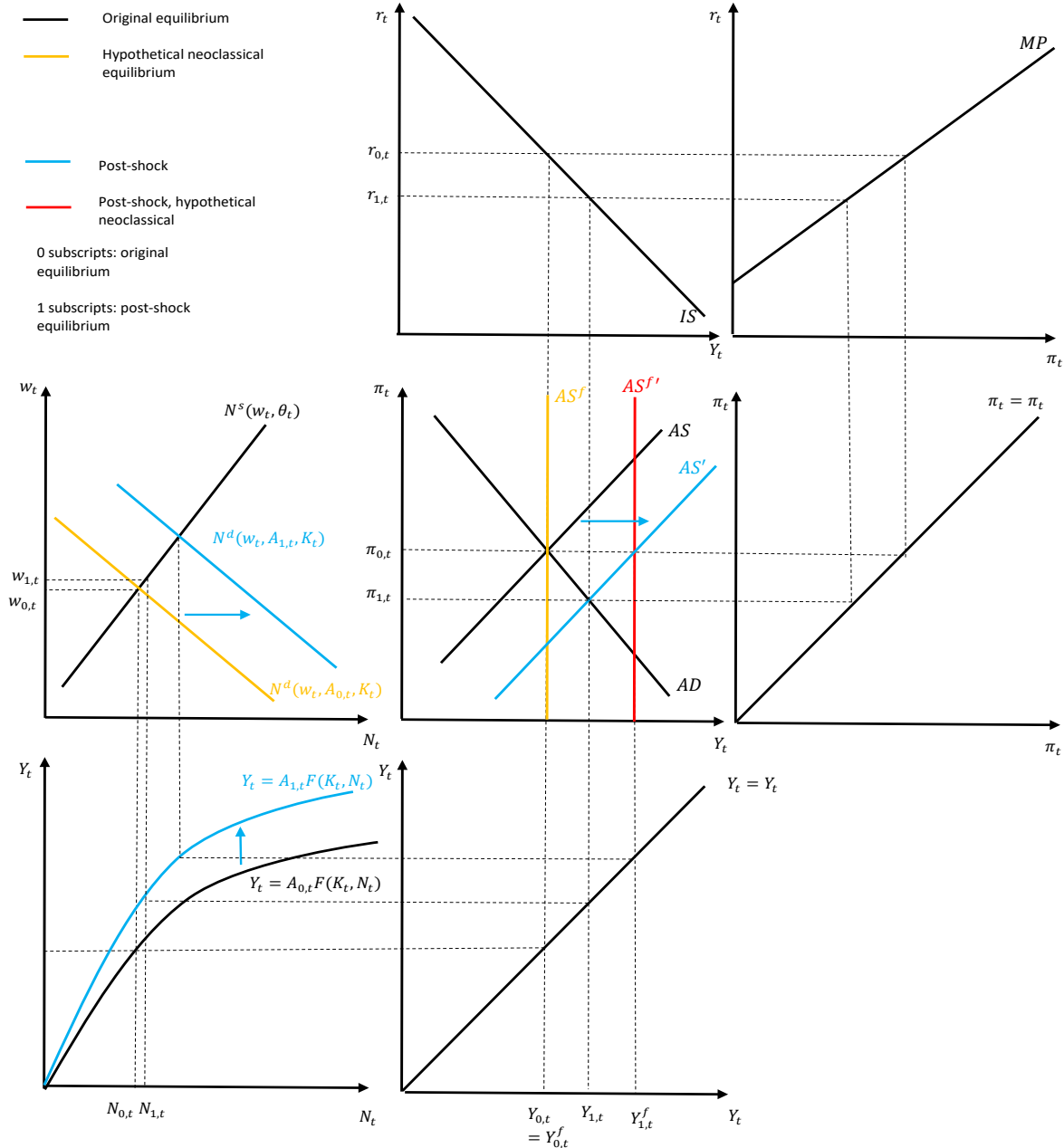

There is no direct effect on the demand side of the model. To figure out how the AS curve shifts, we need to determine how Y_t^f changes. To do so we note that the hypothetical labor demand curve would shift right. Along a stable labor supply curve, in the neoclassical model this would result in higher labor input. Combined with the upward shift of the production

function, this means that Y_t^f increases. The increase in Y_t^f causes the AS curve to shift out to the right. In equilibrium, this results in an increase in output and a reduction in inflation. The reduction in inflation causes the central bank to lower the real interest rate from the MP curve, which results in a movement down along the IS curve consistent with the new equilibrium level of output. Once the new equilibrium level of output is determined by the intersection of the new AS curve with the AD curve, labor market variables can be determined. As in the partial sticky price model presented in the main text, we can determine how N_t and w_t react (i.e. whether they go up or down). In the graph, it is shown where both variables increase slightly. We can determine that both N_t and w_t increase *less* than they would if prices were flexible (i.e. if the AS curve were vertical). Depending on the relative slopes of the AD and AS curves, N_t and w_t could both fall, could both rise, or could both be unchanged.

We leave a graphical analysis of the effects of changes in π_t^e and θ_t as exercises. We simply note that the equilibrium effects of these exogenous shocks are qualitatively similar to the IS-LM-AD-AS model in the text. Indeed, the equilibrium effects in both the IS-LM-AD-AS and IS-MP-AD-AS models are very similar to one another for all shocks. We do not study dynamic transitions from short run to medium run in this appendix. The dynamics are similar to the IS-LM-AD-AS model. If $Y_t \neq Y_t^f$ in the short run, then $\pi_t \neq \pi_t^e$. As time moves forward, this triggers changes in π_t^e which shift the AS curve so as to restore the hypothetical neoclassical equilibrium in the medium run.

We conclude this appendix by briefly discussing optimal monetary policy in the context of the IS-MP-AD-AS model. In Chapter 27, we noted how we could think about optimal monetary policy in the IS-LM-AD-AS model as adjusting M_t in response to shocks so as to target $Y_t = Y_t^f$. For shocks other than changes in \bar{P}_t , this implies stabilizing the price level and allows one to think about an “effective AD” curve that is perfectly horizontal. Something very similar holds in the IS-MP-AD-AS model, though it is perhaps more transparent than in the model presented in the text. In particular, as noted above we can think about the central bank effectively determining the slope of the AD curve through its choice of the parameter ϕ_π . As ϕ_π gets bigger, the AD curve gets flatter, as shown above in Figure E.5. In the limiting case, as $\phi_\pi \rightarrow \infty$, the AD curve becomes completely horizontal. With a horizontal AD curve, shocks to the IS curve will not impact output, and shocks to Y_t^f will result in output moving by the same amount. We say that a central bank following an MP rule with a very large ϕ_π is following a strict inflation target. This is the optimal rule to follow provided that exogenous shocks to π_t^e are not very important.